

MOSTY DREWNIANE.

ZESZYT II.

MOSTY KRATOWE I ROZPOROWE.

WYKŁADY

MAKSYMILIANA THULLIEGO,

DYPLOMOWANEGO INŻYNIERA, PROFESORA SZKOŁY POLITECHNICZNEJ WE LWOWIE.



B. ATLAS.

Cena za tekst i atlas 5 zł.

LWOW, 1898.

SKŁAD GŁÓWNY U KAZIMIERZA JAKUBOWSKIEGO WE LWOWIE.

I. ZWIĄZKOWA DRUKBRNIA WE LWOWIE.

SPIS TABLIC.

- | | |
|---|---|
| Tabl. 1. i 2. Most kratowy układu inż. Ibjańskiego. | Tabl. 45. i 46. Mosty Howe'a i Whipplego. |
| " 3. i 4. Most drogowy układu Rychtera. | " 47. Zetknięcie pasu. |
| " 5. i 6. Most kolejowy układu Rychtera. | " 48. i 49. Obliczenie belki Pintowskiego. |
| " 7. i 8. Belka Towna. | " 50. i 51. Obliczenie belki Rychtera. |
| " 9. i 10. Szczegóły. | " 52. i 53. Most kolejowy układu Rychtera. |
| " 11. i 12. Most układu Ibjańskiego. Nowy ustrój. | " 54. i 55. Obliczenie belki Howe'a. |
| " 13. i 14. " " " " " | " 56. i 57. Most kratowy Howe'a węgierskich |
| " 15. Mosty amerykańskie. | kolei państwowych o pomoście górą a roz- |
| " 16. Mosty Howe'a w kantonie Berneńskim. | piętości 15 m. |
| " 17. Most Howe'a na rzece Emmie w Szwajcaryi. | " 58. i 59. Most kratowy Howe'a o pomoście do- |
| " 18. Most Howe'a kolei południowej. | łem a rozpięt. 15 m. |
| " 19. i 20. Mosty systemu Howe'a kolei pół- | " 60. i 61. Most kratowy Howe'a o pomoście górą |
| dniowej austriackiej. | a rozpiętości 30 m. |
| " 21. Most kolei zachodniej amerykańskiej. | " 62. i 63. Most kratowy Howe'a o pomoście do- |
| " 22. Most drewniany kolei zachodniej amery- | łem a rozpiętości 30 m. |
| kańskiej. | " 64. i 65. Rozpornice trapezowe. |
| " 23. Mosty kolejowe. | " 66. Rusztowanie wiaduktu na Wełtawie w Čer- |
| " 24. Most kolei węg. wschodniej na rzece Ara- | venie. |
| nyos. | " 67. i 68. Mosty rozporowe francuskie. |
| " 25. Most tymczasowej kolei berlińskiej obwo- | " 69. i 70. Normalia kolei arc. Albrechta. Most |
| dowej. | rozporowy. |
| " 26. Mosty Towna i Howe'a. | " 71. i 72. Most na Saali w Bernburgu. |
| " 27. i 28. Most układu Rychtera o pomoście | " 73. Rozpornica wielokrotna. |
| górami. | " 74. i 75. Typy mostów drewnianych w kanto- |
| " 29. i 30. Most drogowy Rychtera o pomoście | nie Berneńskim. |
| dołem. | " 76. i 77. Rozpornice trapezowe. |
| " 31. i 32. Most na Strypie pod Buczaczem układu | " 78. i 79. Rozpornica wielokrotna. |
| Pintowskiego. | " 80. Rozpornica trapezowa. |
| " 33. i 34. Most na Strypie pod Buczaczem układu | " 81. i 82. Rozpornice i wieszary. |
| Pintowskiego. | " 83. i 84. Mosty rozporowe. |
| " 35. i 36. Most na Sanie w Przemyśle. | " 85. i 86. Most na Sanie w Przemyśle. |
| " 37. Mosty amerykańskie. | " 87. Obliczenie rozpornicy trapezowej. |
| " 38. Szczegóły. | " 88. Obliczenie wykreślne rozpornic. |
| " 39. i 40. Most Howe'a na rzece Steyr. | " 89. i 90. Mosty łukowe. |
| " 41. i 42. Szczegóły mostów Howe'a. | " 91. i 92. Most rozporowy na Dunaju w Stadlau |
| " 43. i 44. Most kolejowy pod Waltenhofen w Ba- | pod Wiedniem. |
| waryi. | " 93. i 94. Mosty tymczasowe. |

Biblioteka Politechniki Krakowskiej



100000249940



IV - 200753

5-182/2013

Most kratowy
układu inżyniera Ibjanokiego

Rys1 Widok z boku

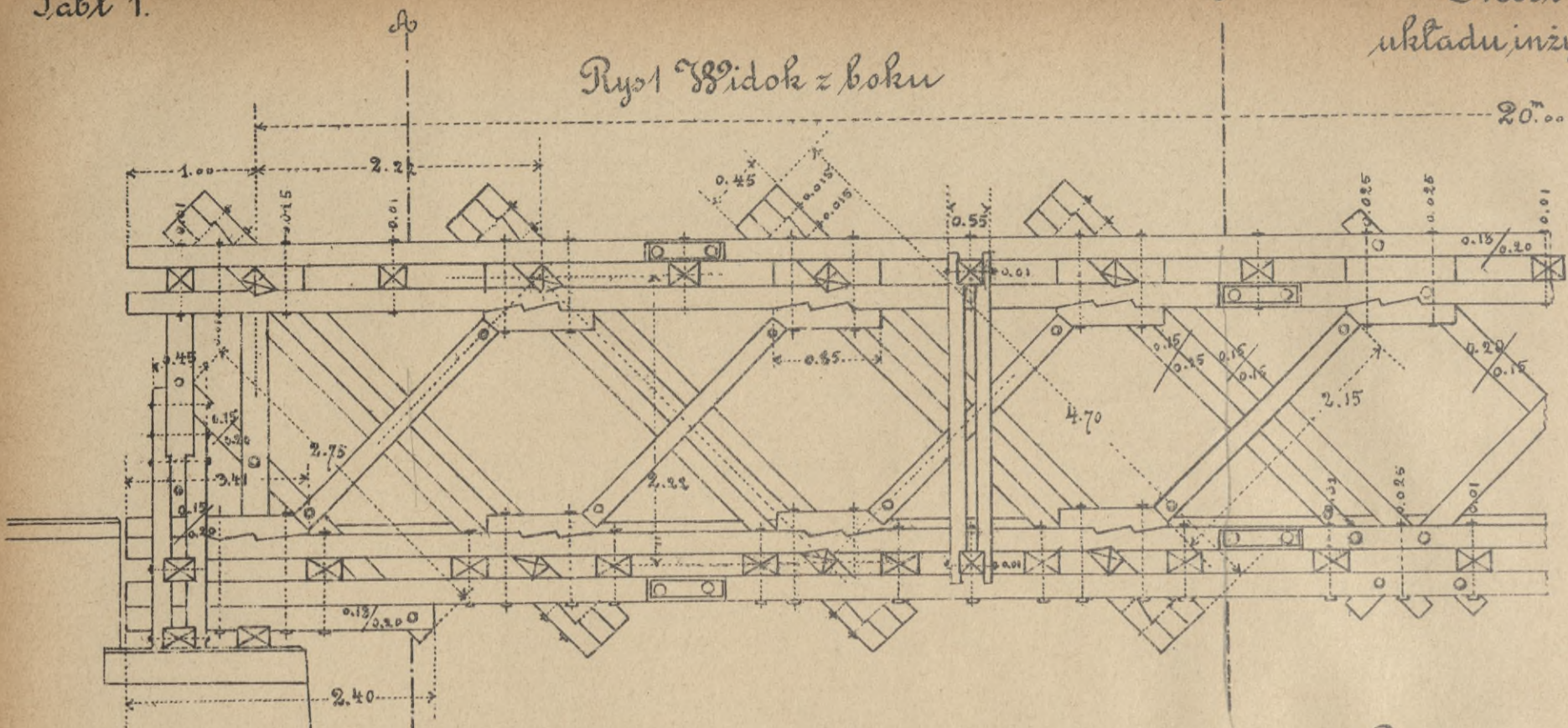

Rys2 Rzut poziomy

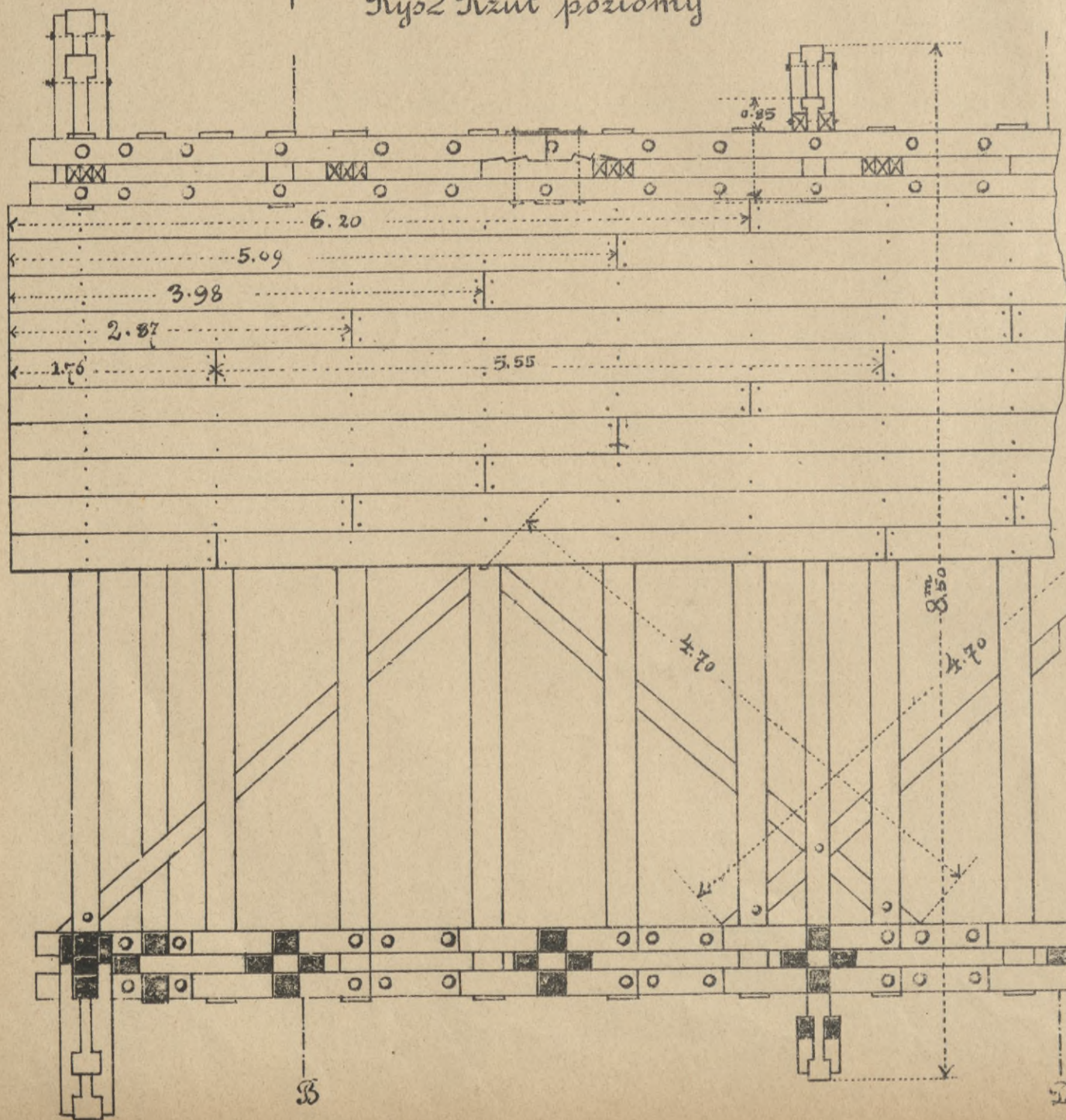

Wzrost

Rys4.a

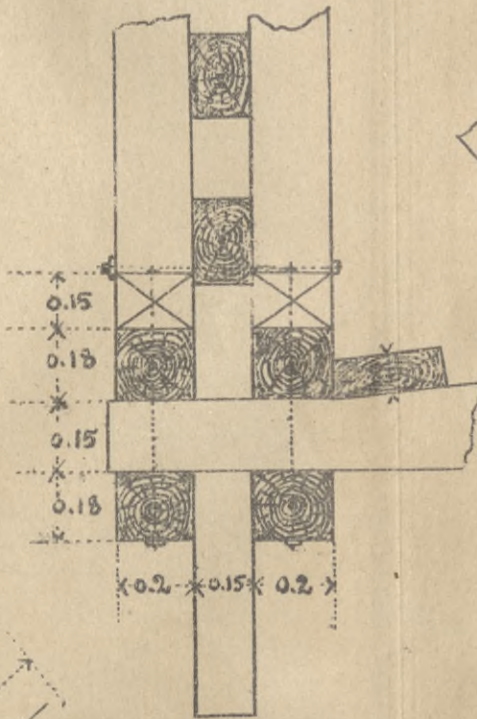

Rys4.b

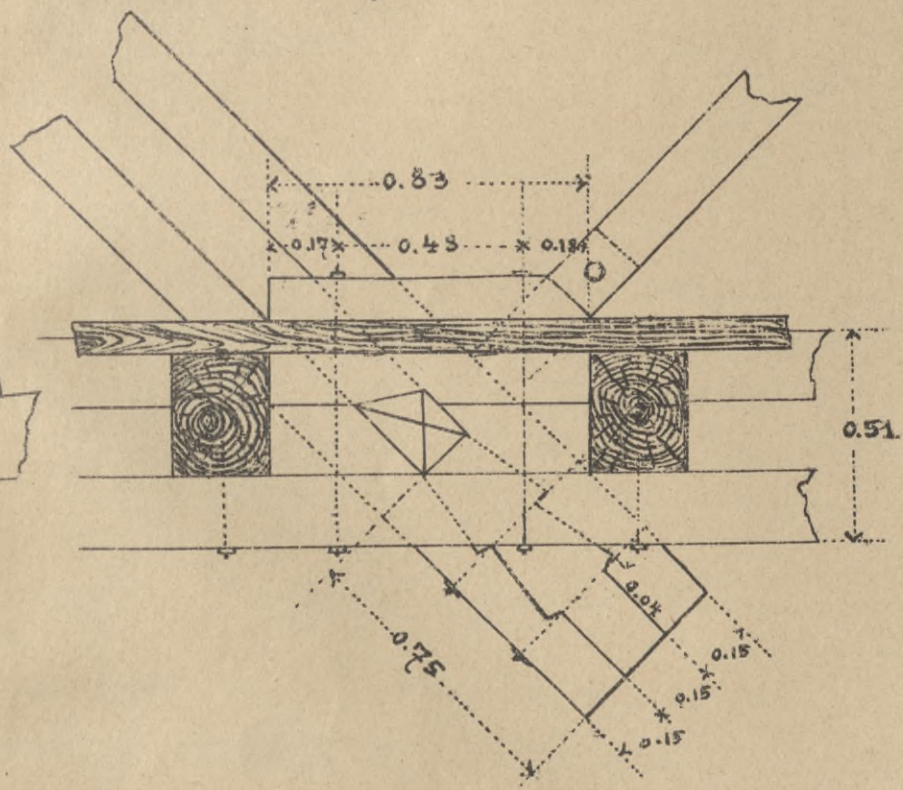

Rys3. Przekrój poprzeczny

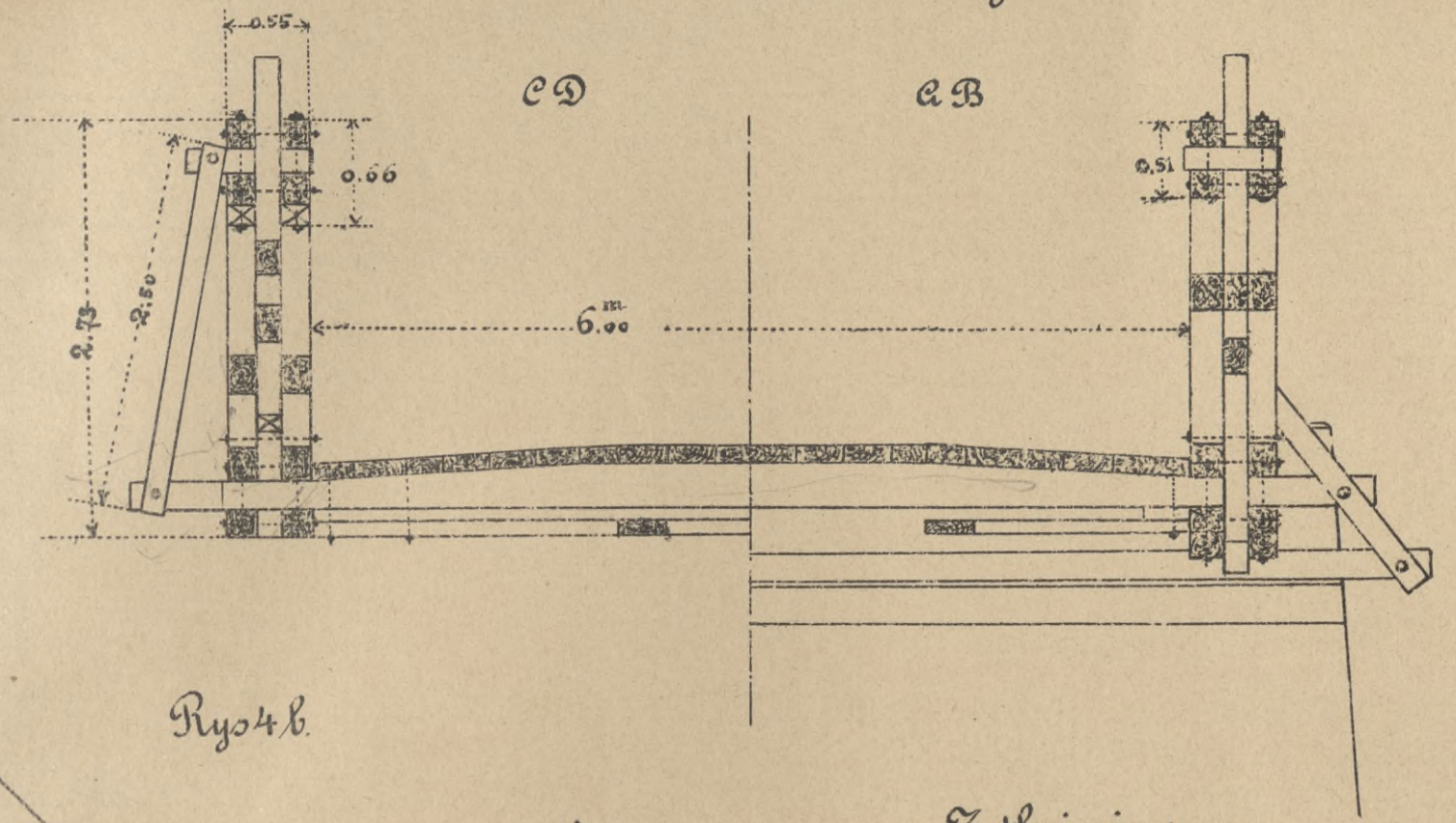

Zetknięcie pasu

Rys5.a

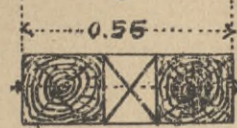

Rys5.b

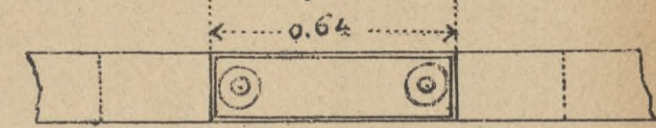

Rys5.c

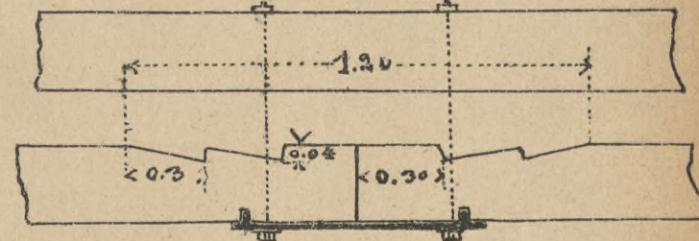

1:20

Rys6. Rozkład zetknięć w pasach

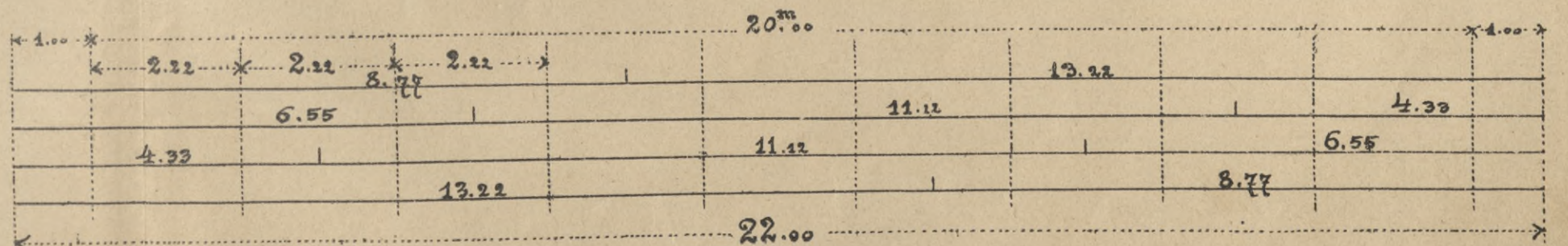

Podziałka 1:50

Most drogowy układu Rychtera

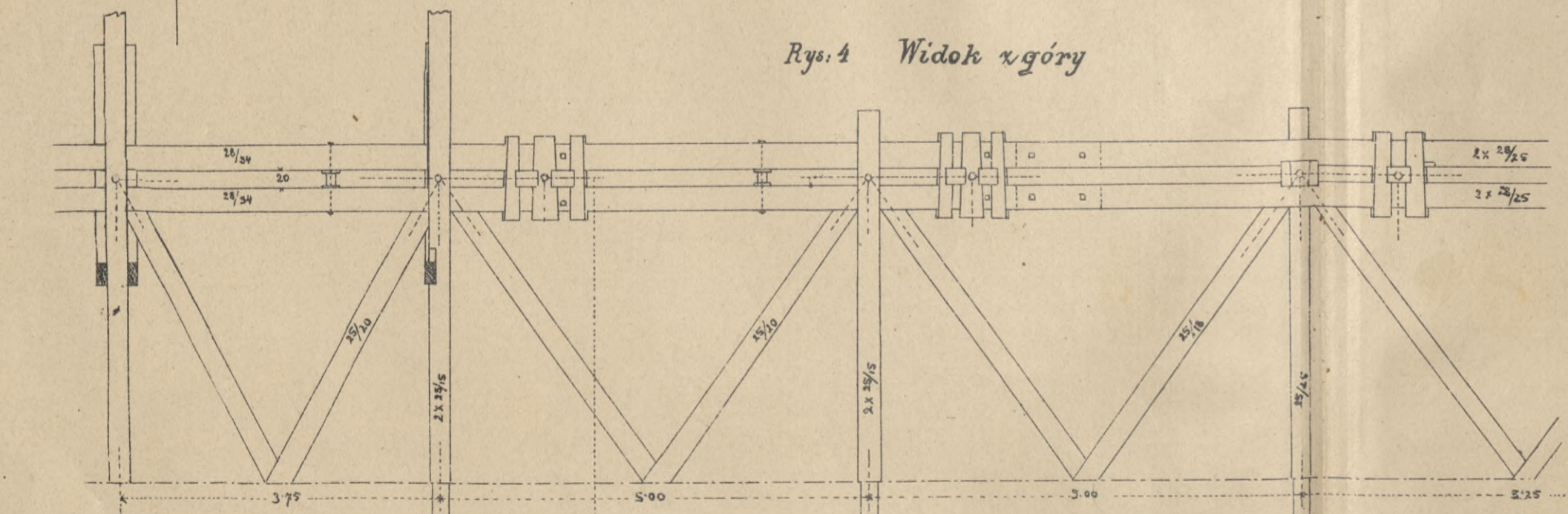
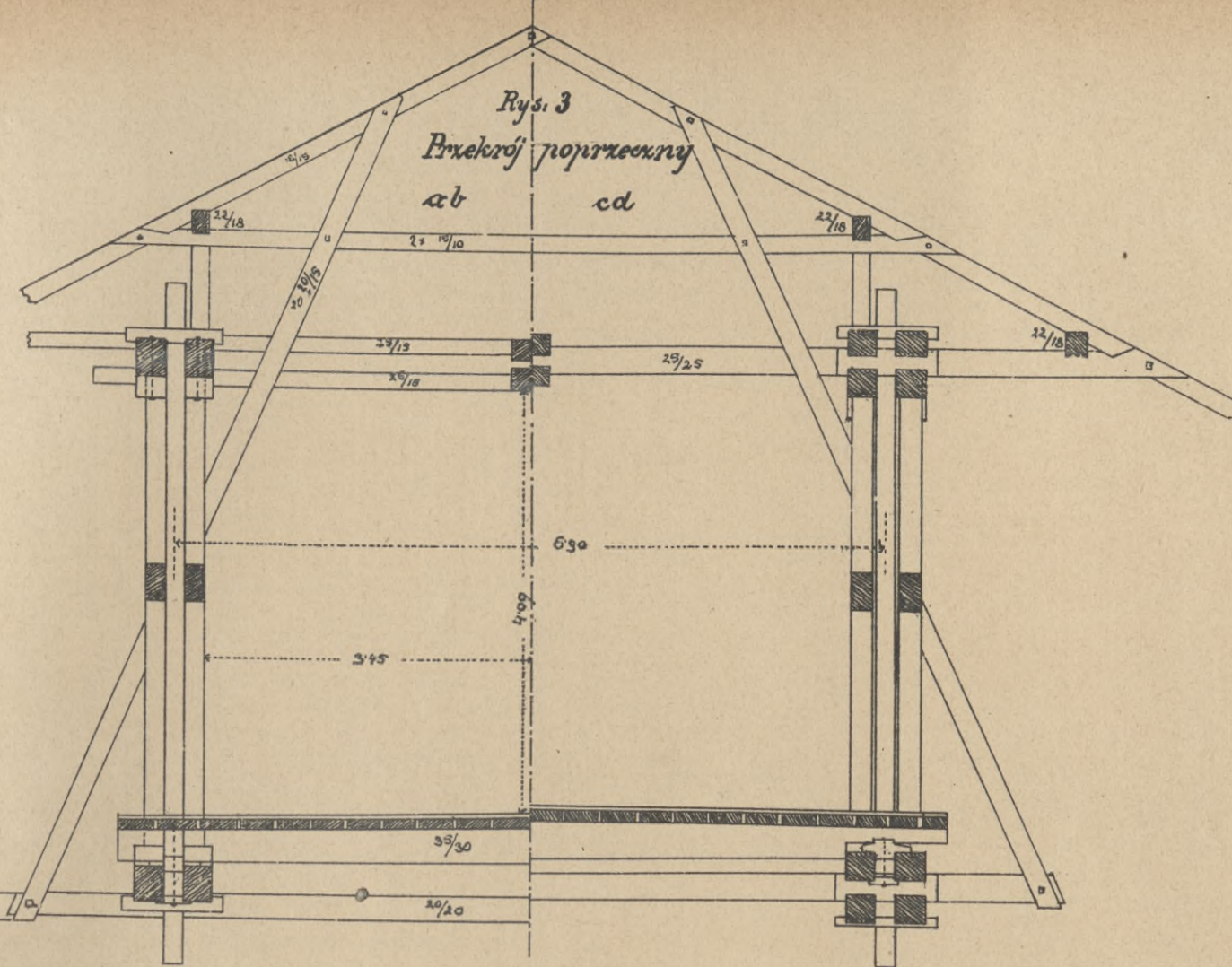
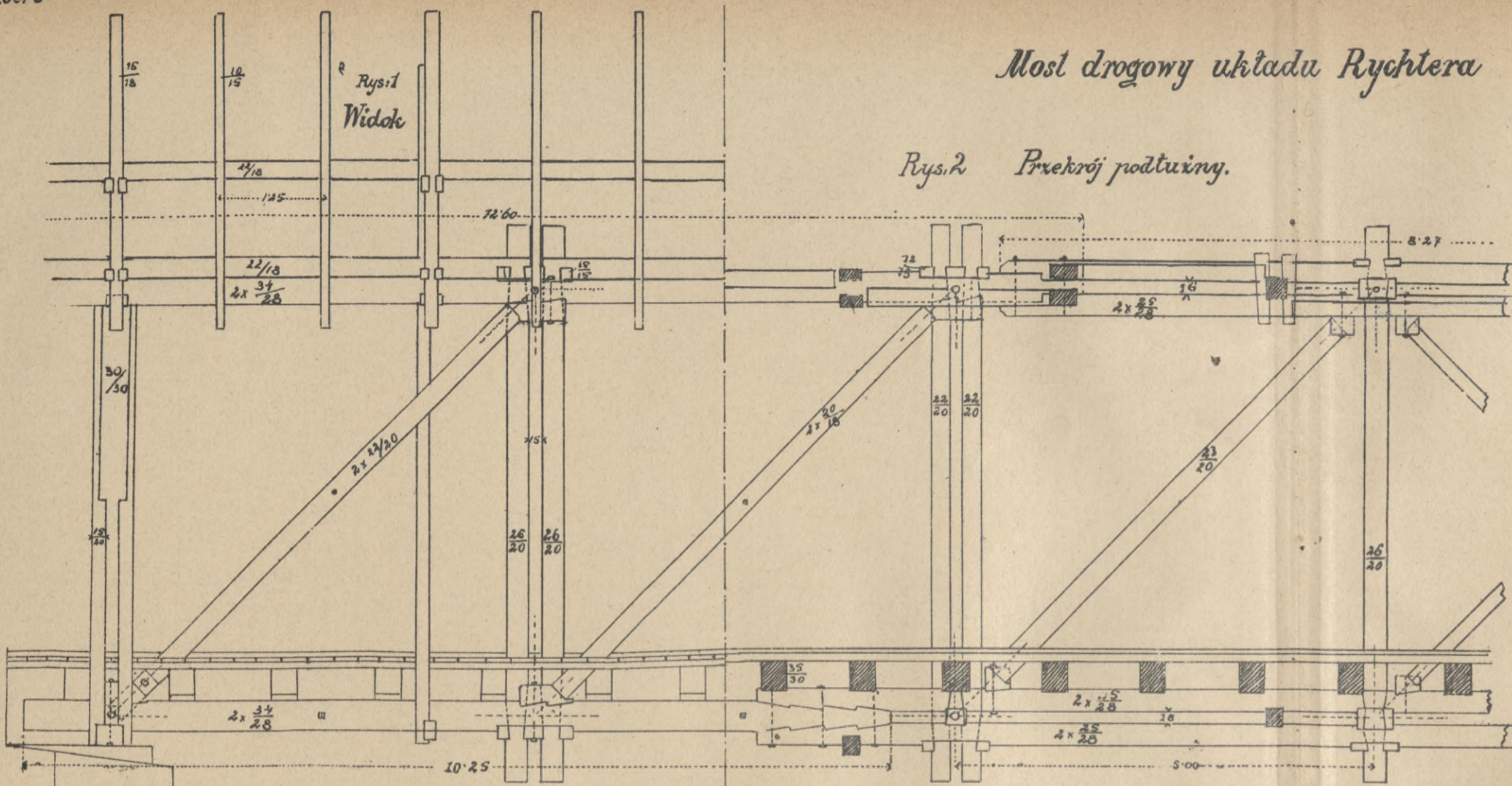

Łożyska poprzeczne

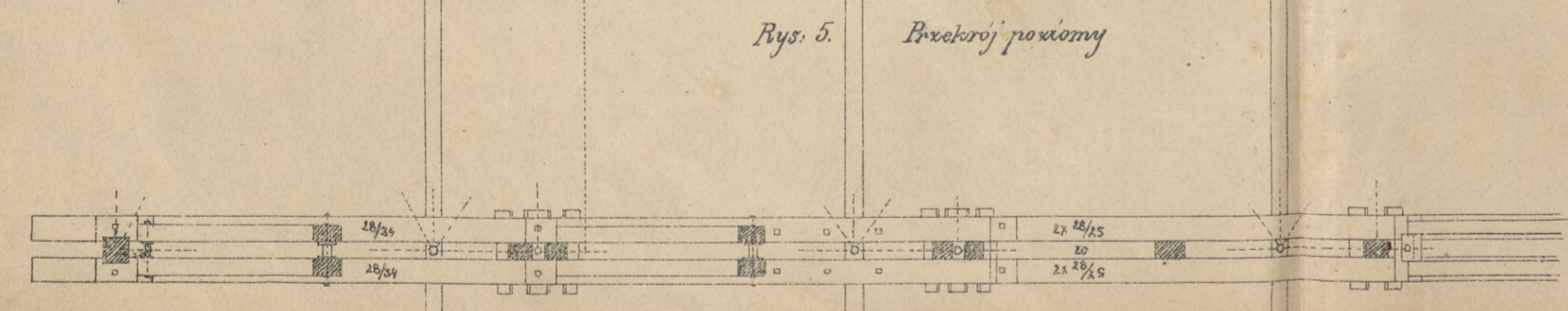
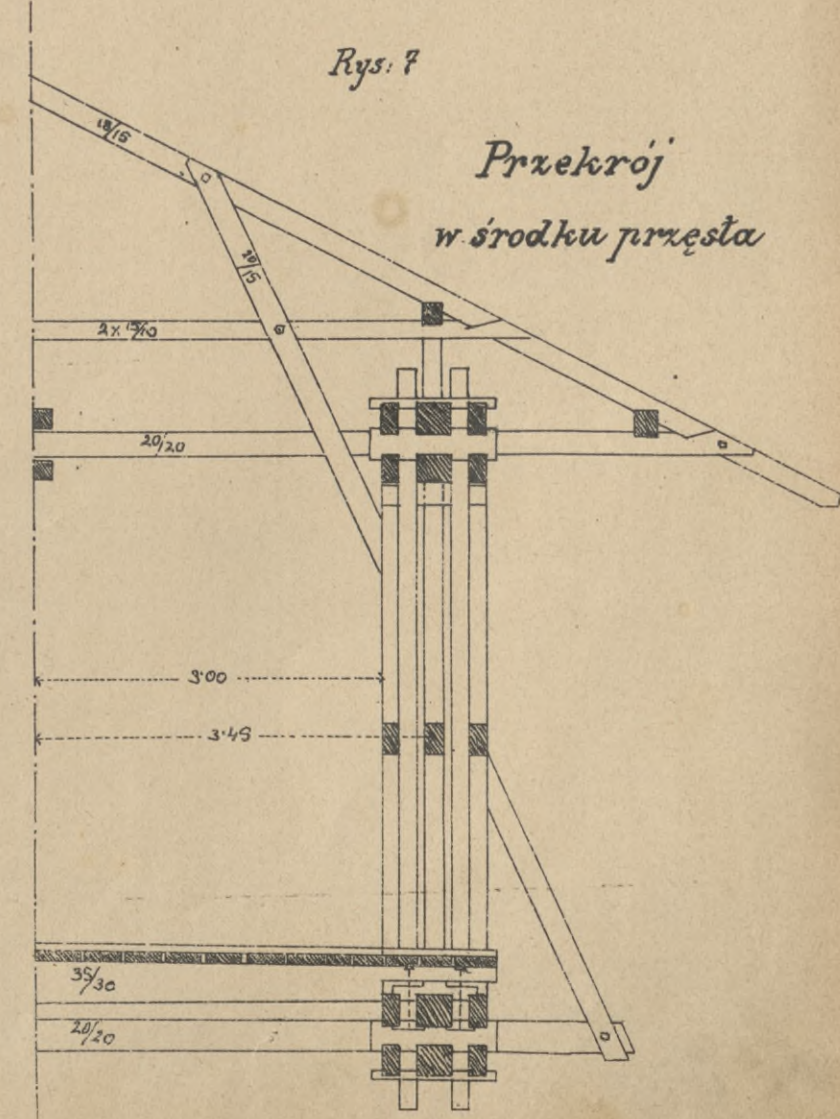
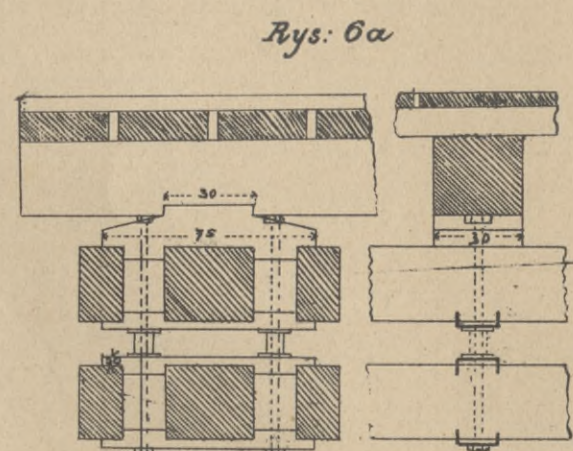

Podziałka: 1cm / 0.8m

Most kolejowy układu Rychtera.

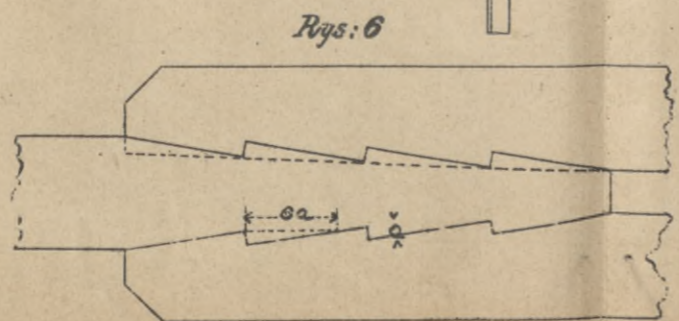
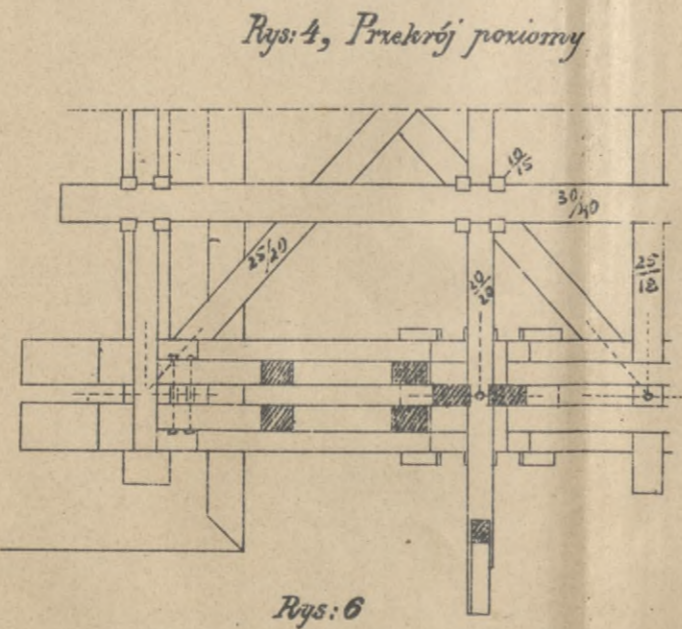
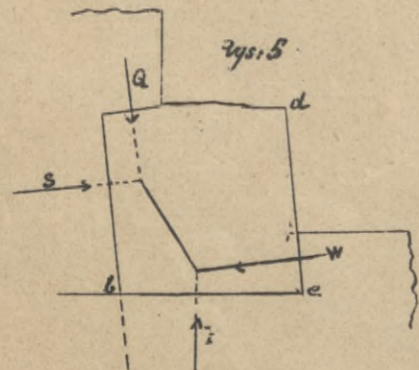
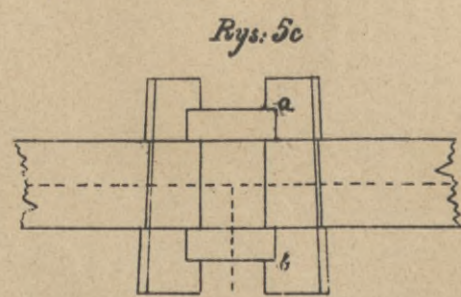
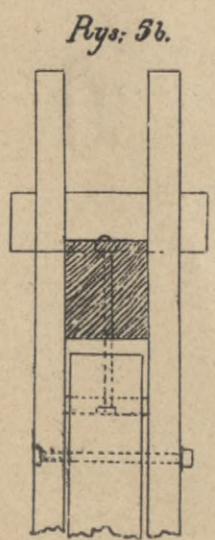
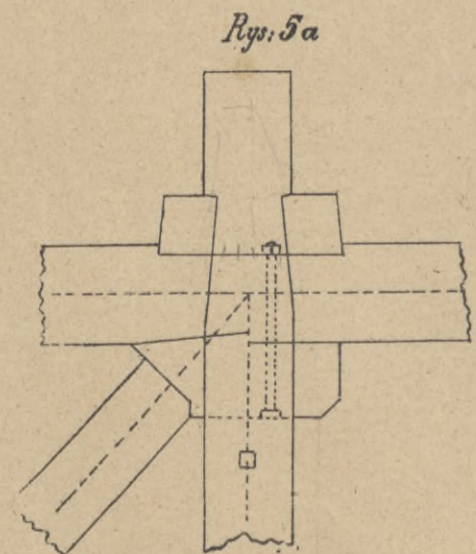
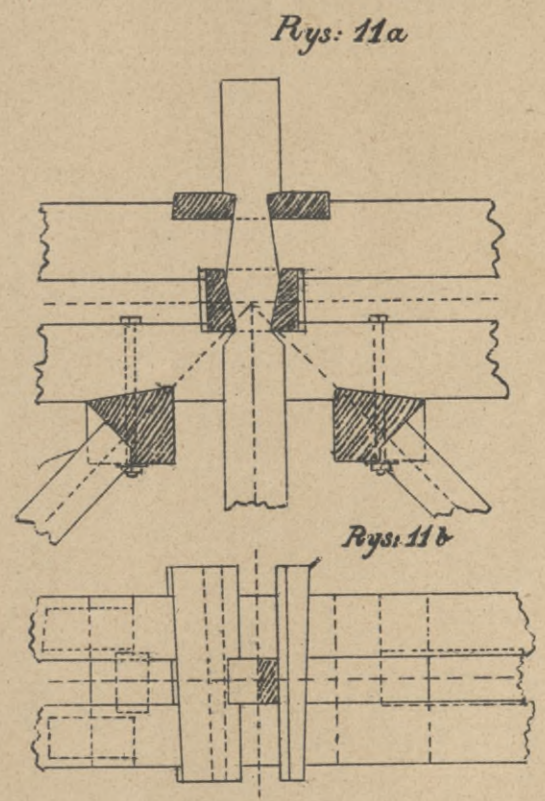
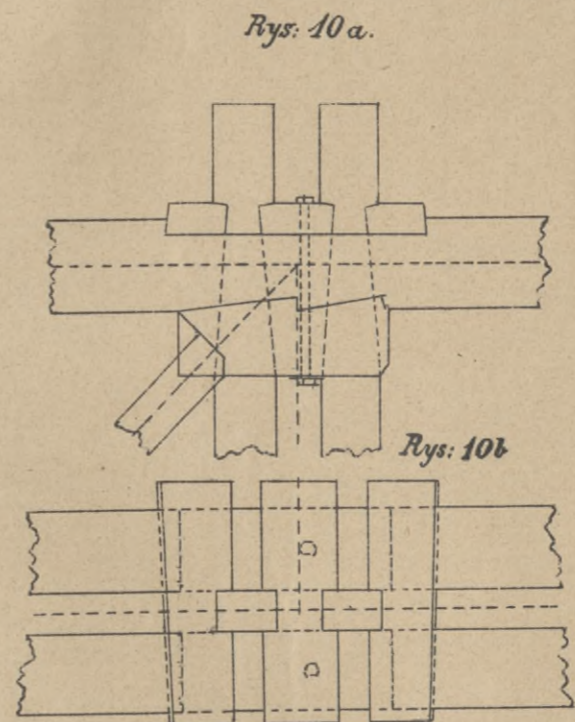
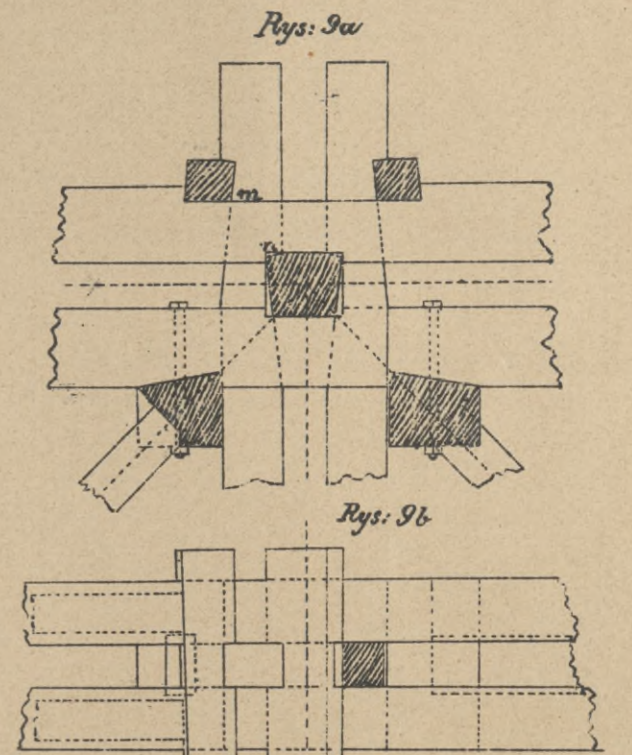
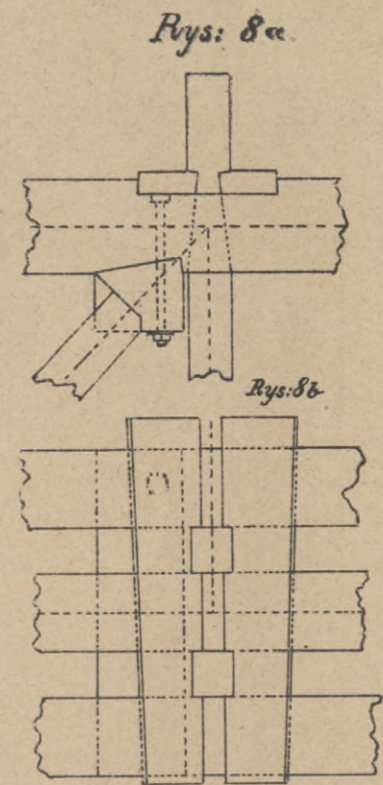
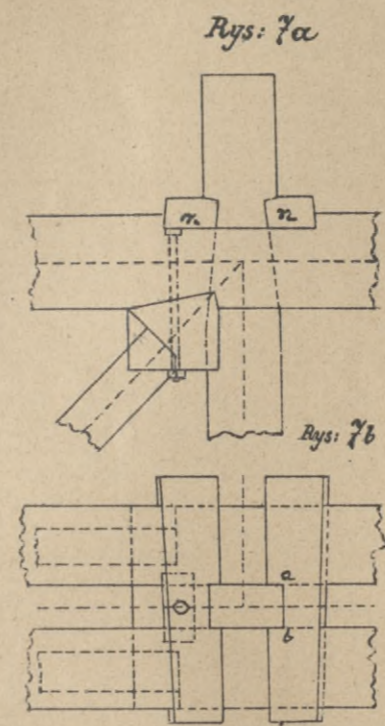
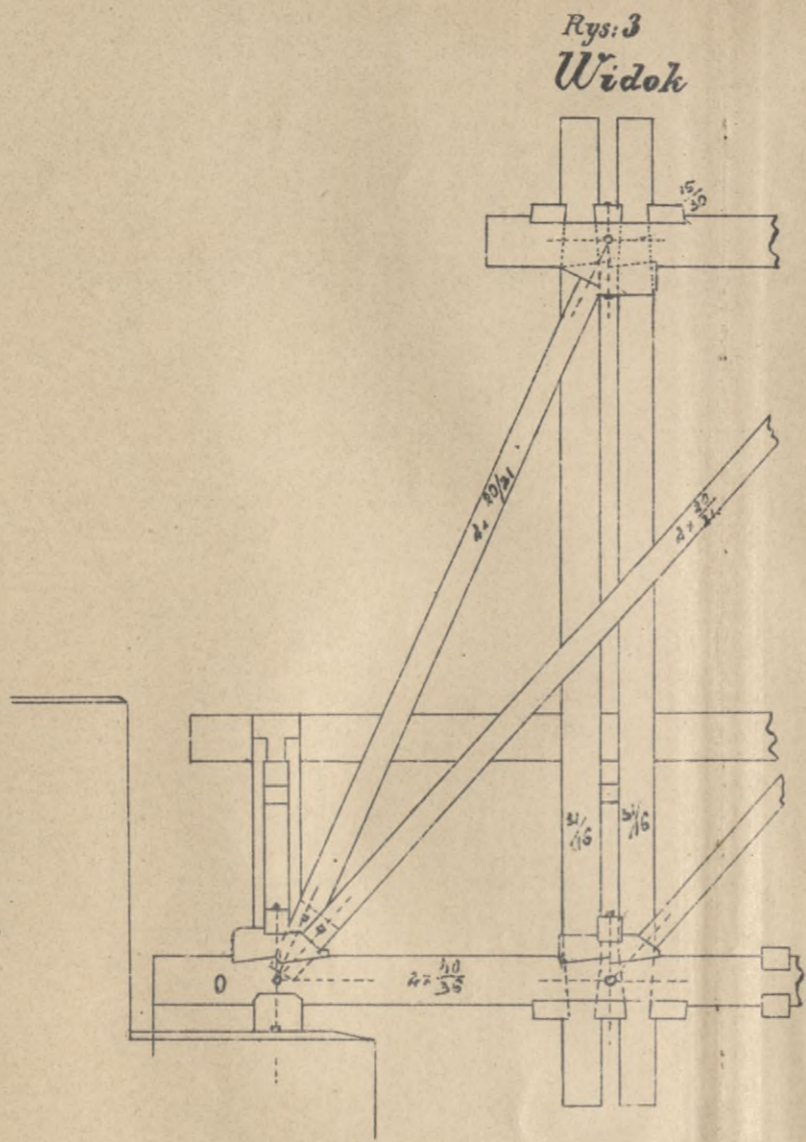
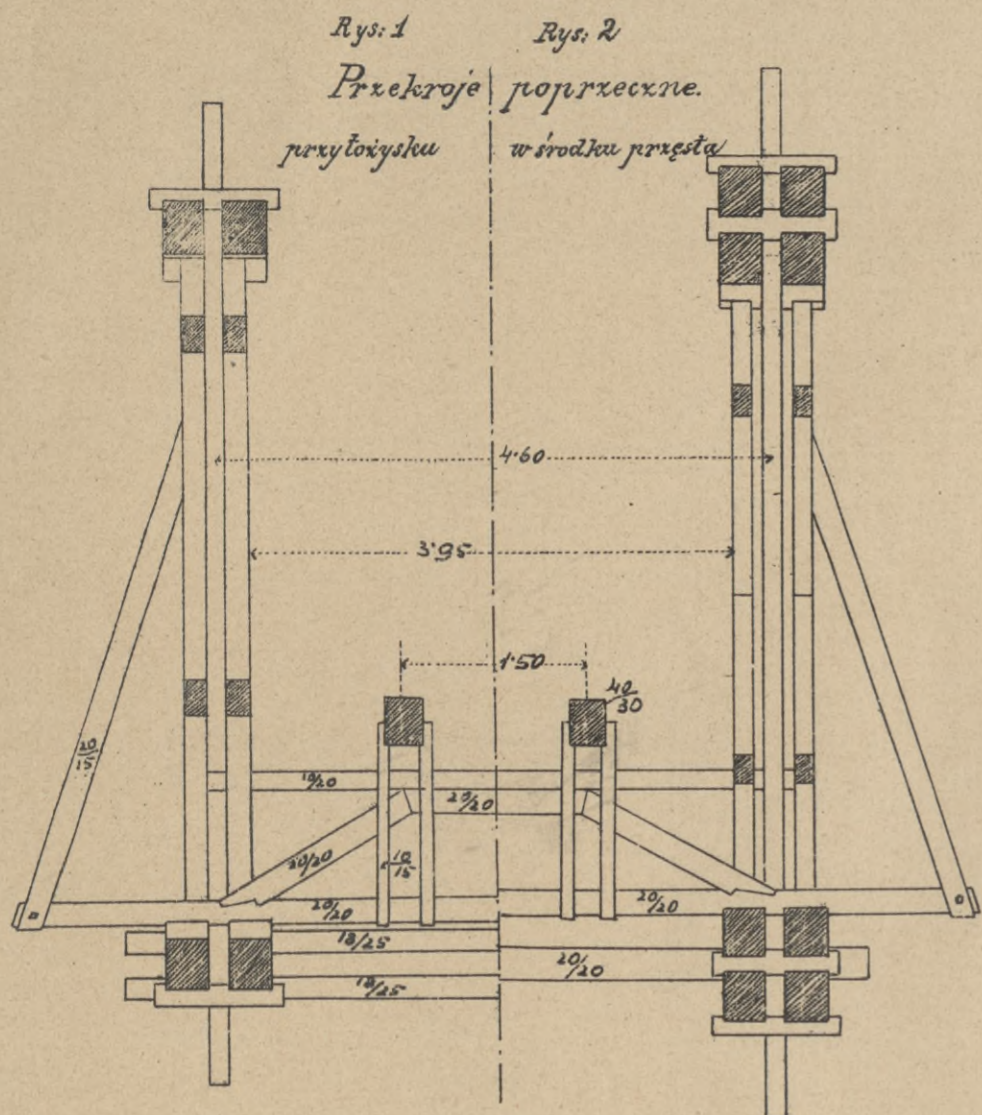

Rys. 12
Połączenia pasu

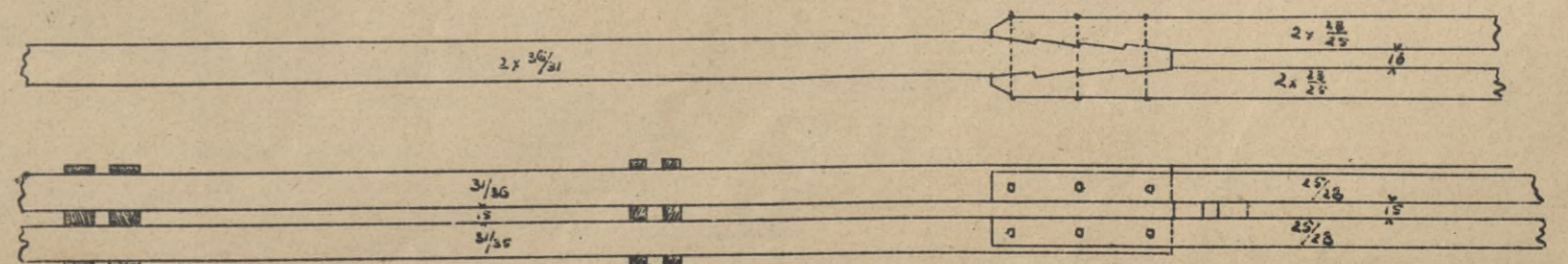

Rys. 1a Wiadukt w Lemington
Przekrój

Rys. 1b.
Widok

Rys. 1c

Szeregót

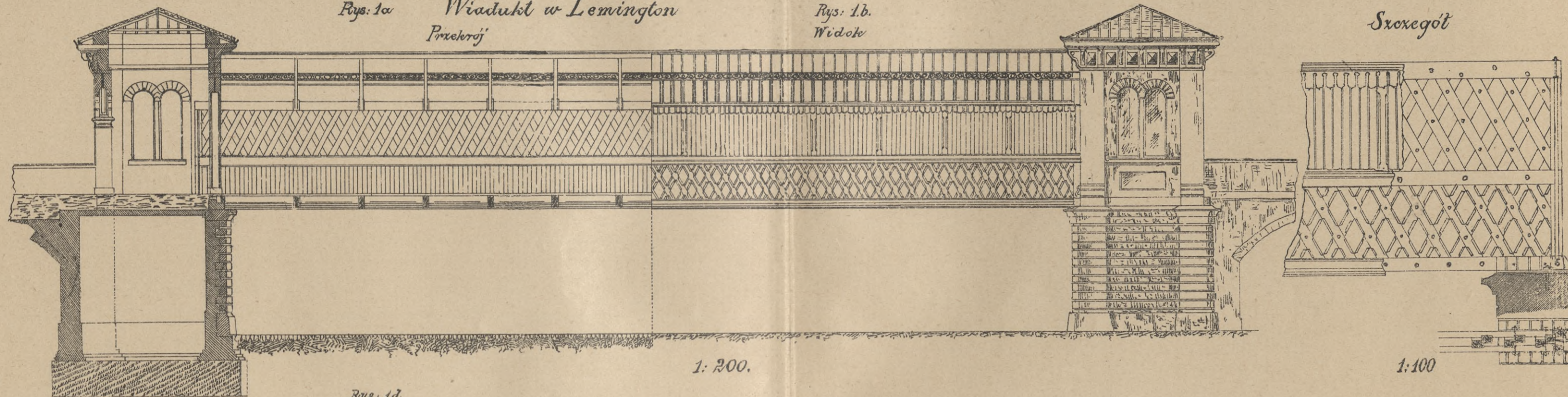

Rys. 1d
Szeregót

Rys. 1e

Przekrój poprzeczny

Most w Unter-Beuern (Badenskie)

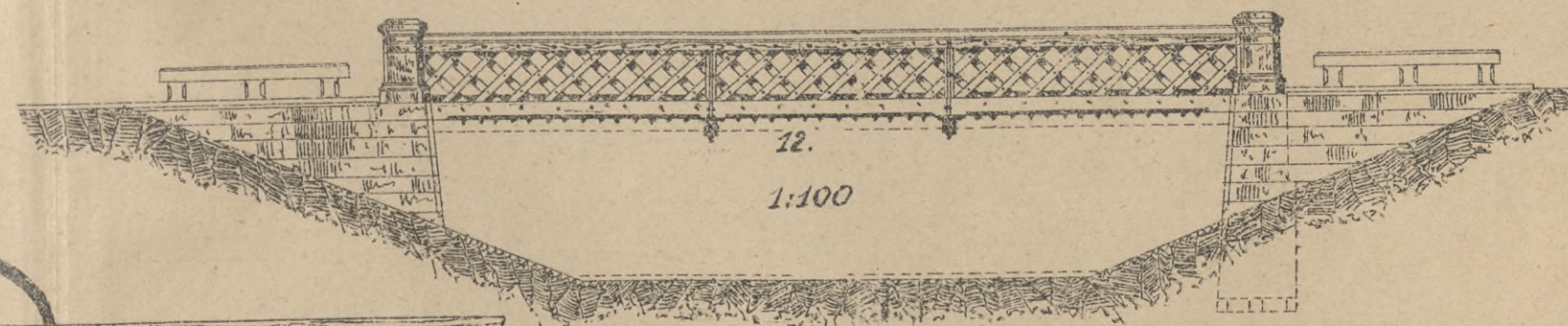
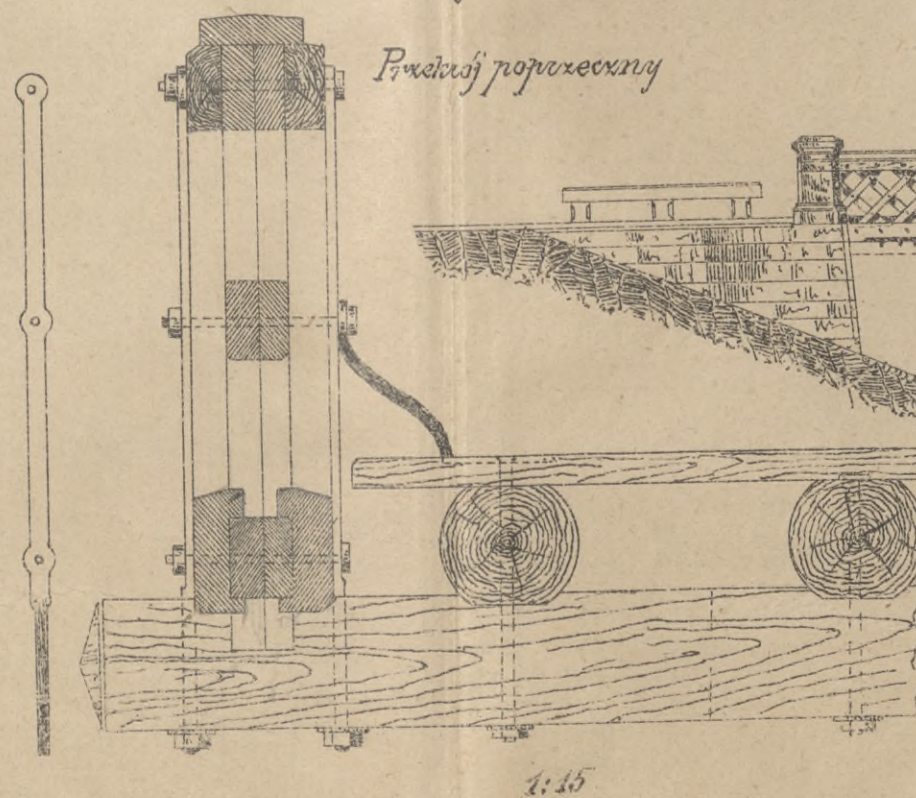
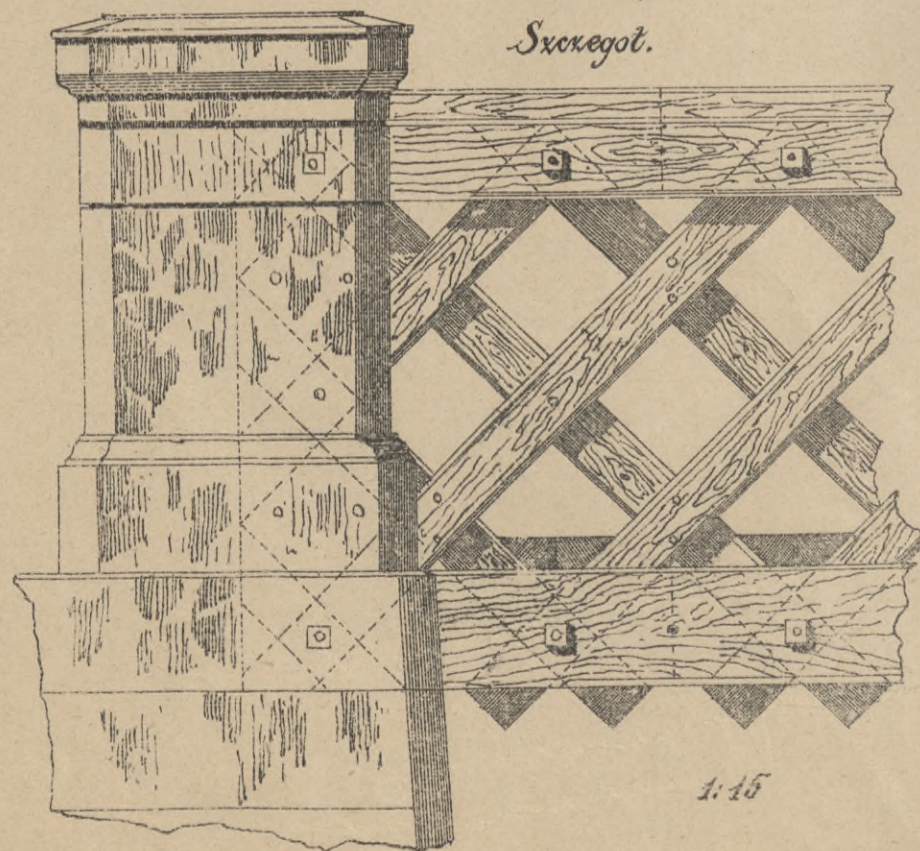

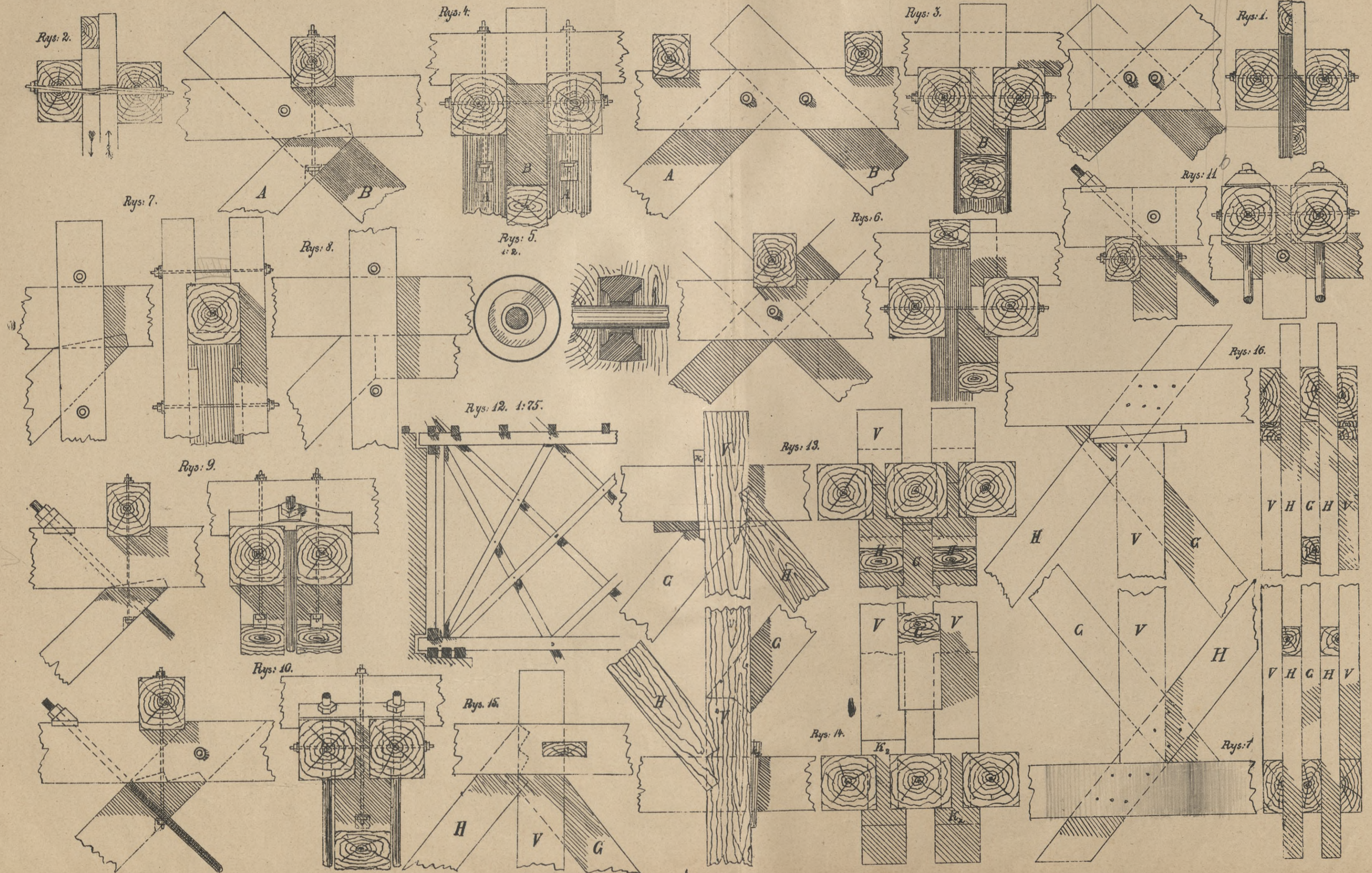

Rys. 1, Przekrój a-b i widok.

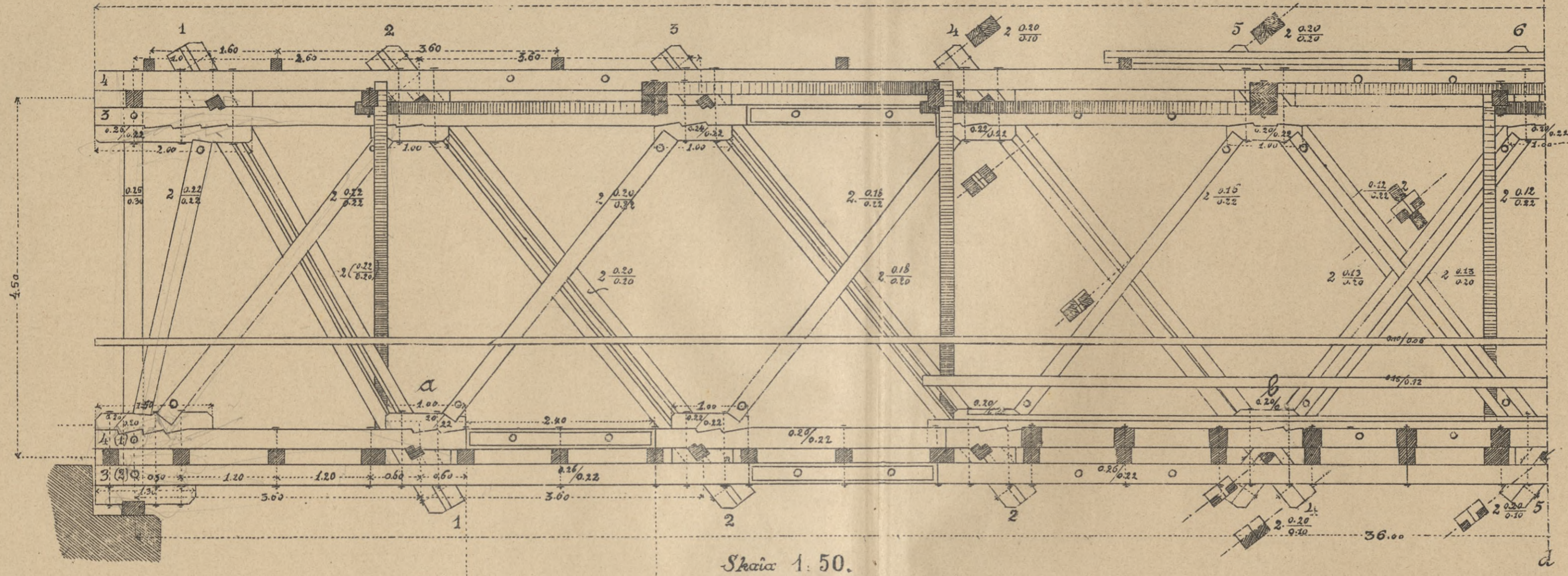

Rys. 2,

Widok w rzucie poziomym.

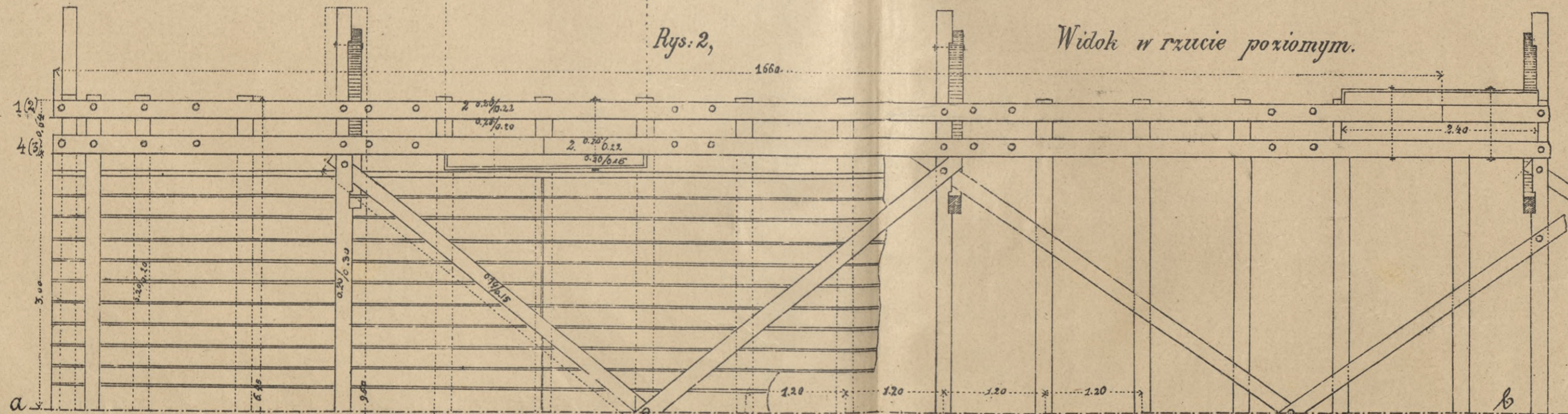

Rozkład belek w pasach

16.70			16.70, 14.40		14.40, 5.90	5.90
13.10			13.10, 14.40		14.40, 9.50	9.50
9.50		9.50, 14.40			14.40, 13.10	13.10
5.90	5.90, 14.40			14.40, 16.70		16.70

1:100

Rys. 1, Przekrój poprzeczny C-D

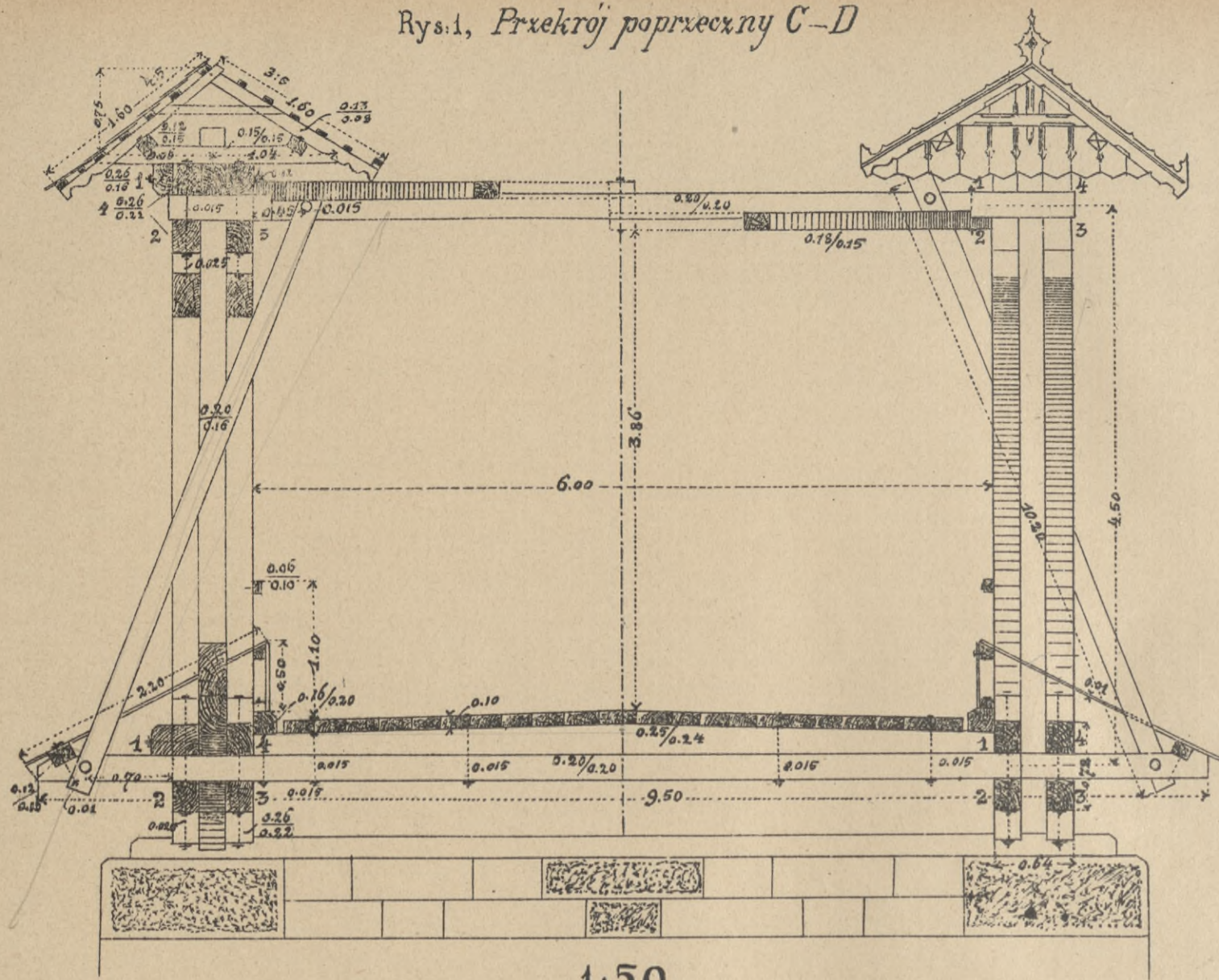

1:50

Rys. 2a.

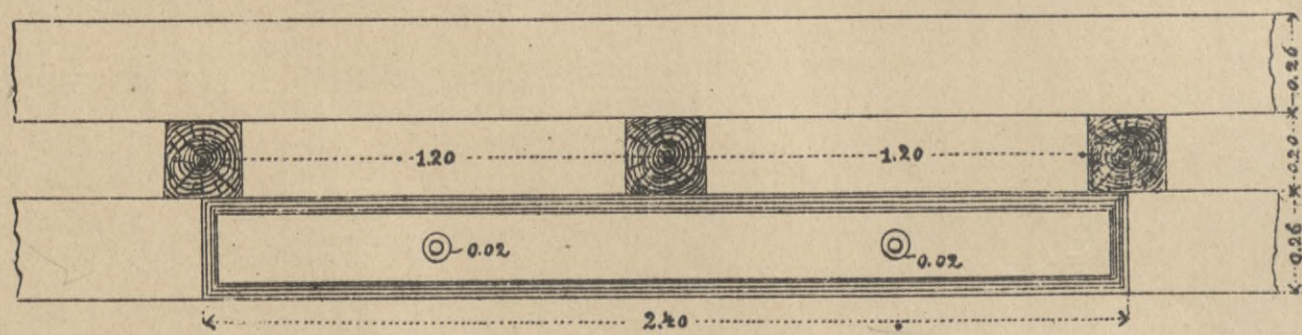

Rys. 2b. Sposób połączenia belek pasowych.

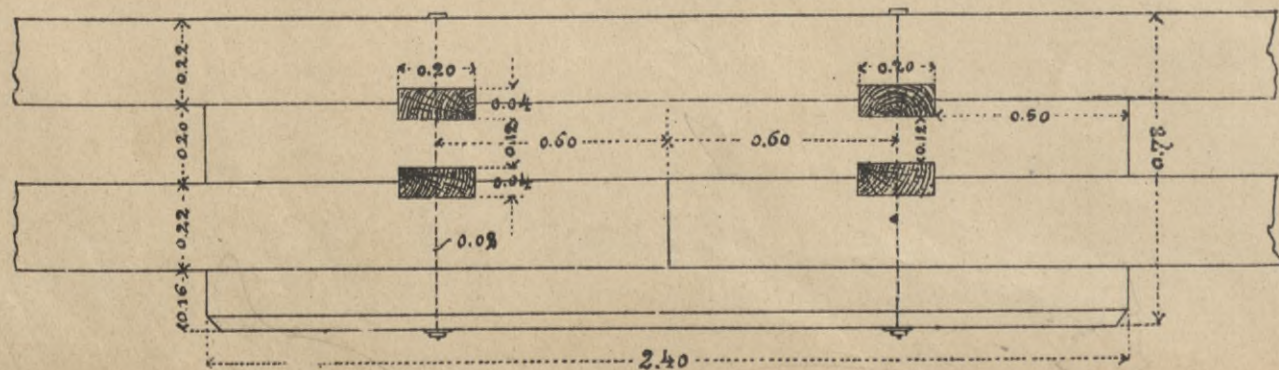

1:20

Rys. 3, Szczegół a.

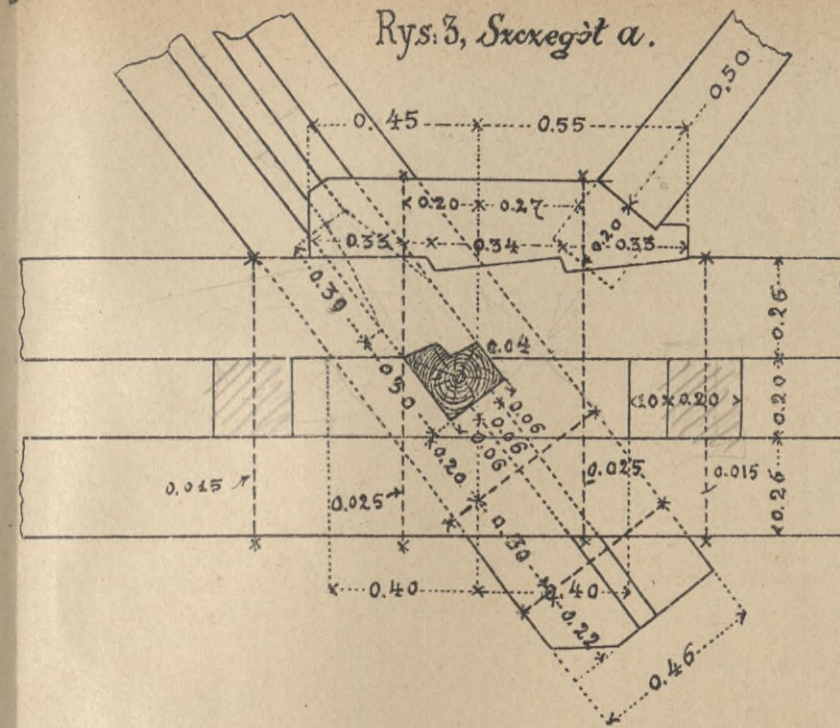

Szczegóły.

Skala 1:20.

Rys. 4, Szczegół c.

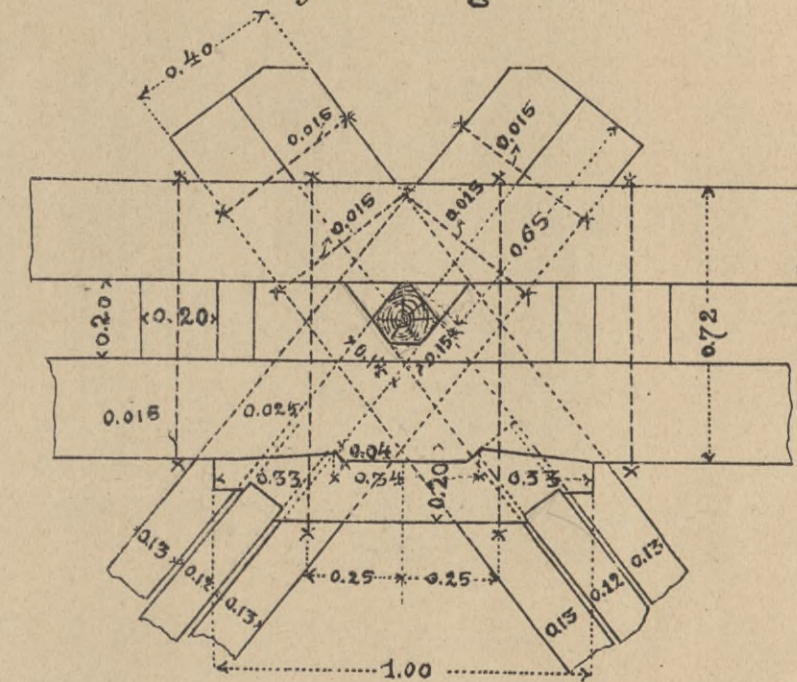

Rys. 5, Szczegół b.

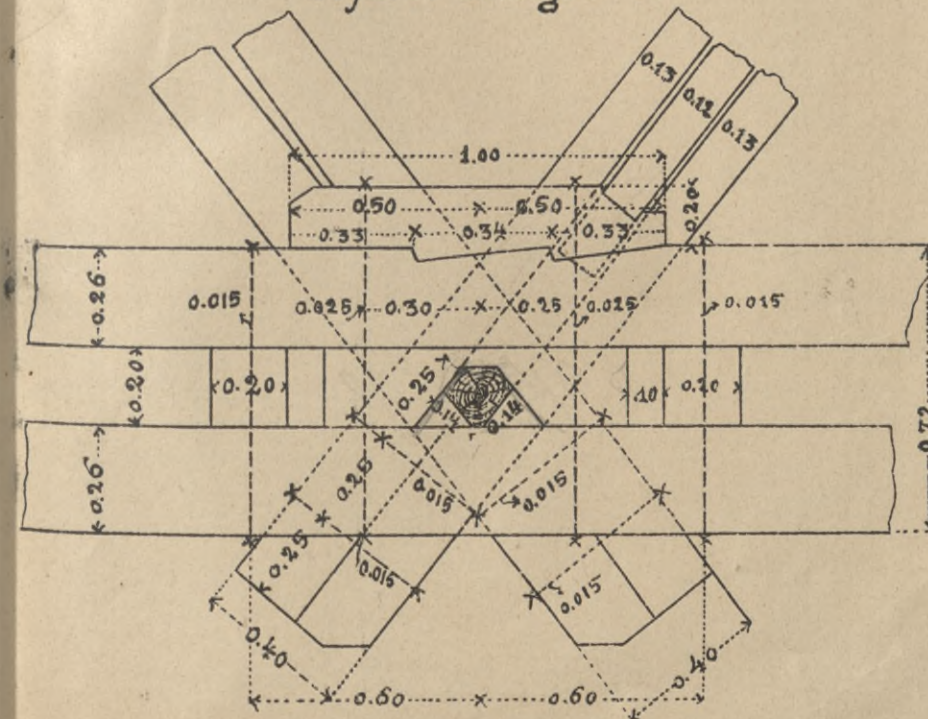

Rys. 1a. Most systemu Towna.

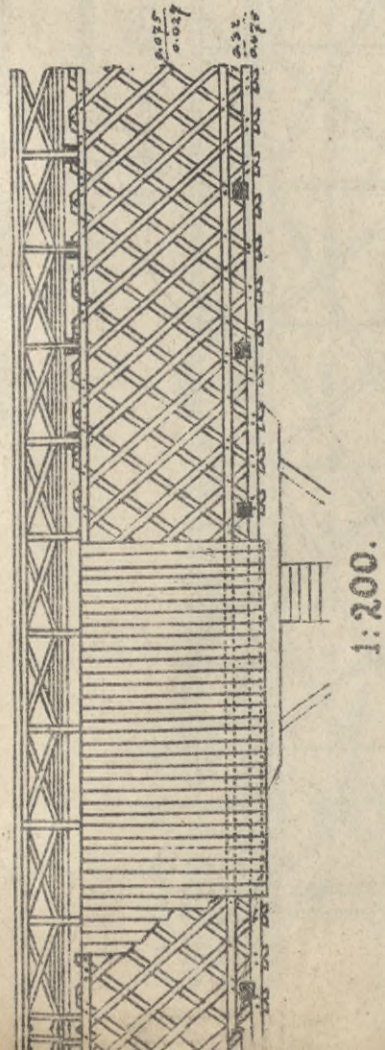

1:200.

Mosty amerykańskie.

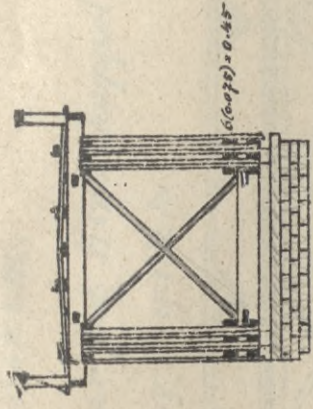

1:200.

Rys. 3c. Tab 15

Szwajcyr polaczenia.

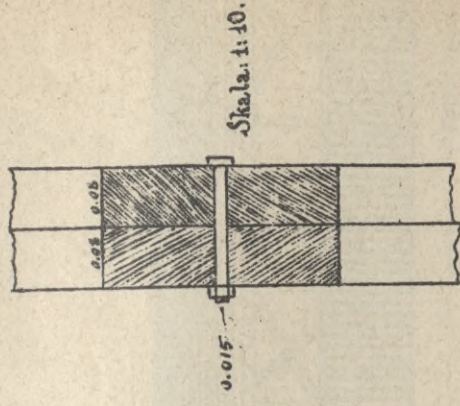

Skala. 1:10.

Rys. 1 b.

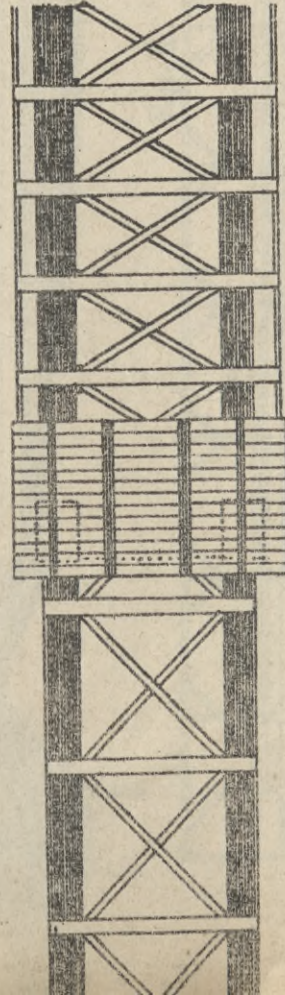

1:200

Rys. 3a. Most przewieszonyy St. Michel.

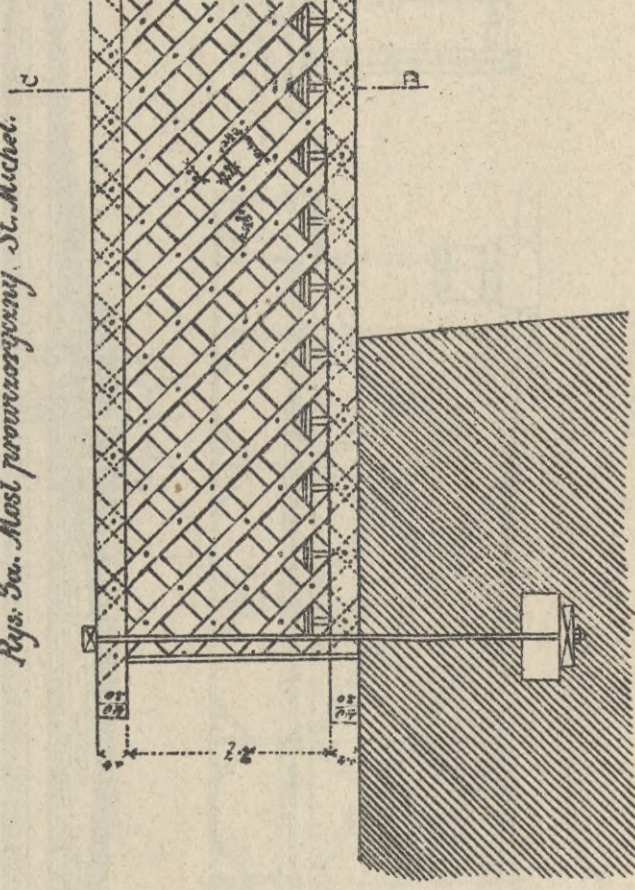

1:100

Rys. 3b, Przekroj C-D.

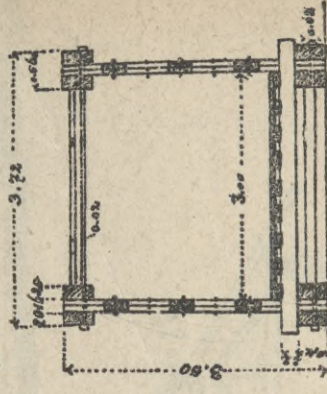

Rys. 2. Most w Richmond.

1:500,

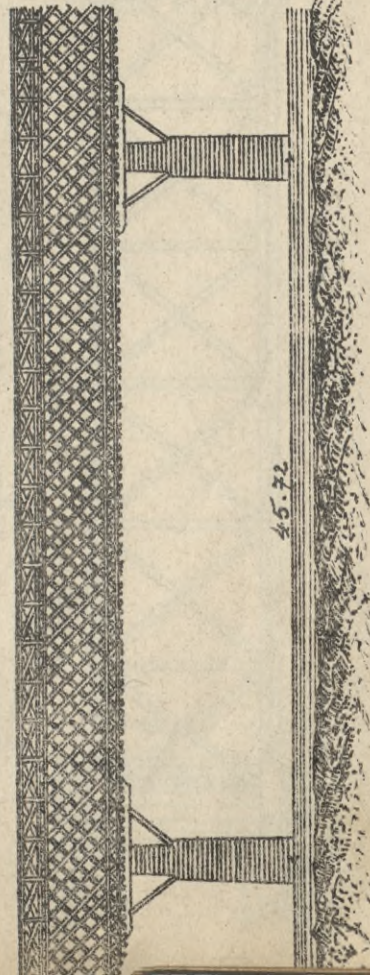

45.72

Rys. 4. Most ukladu Longa. 1:300.

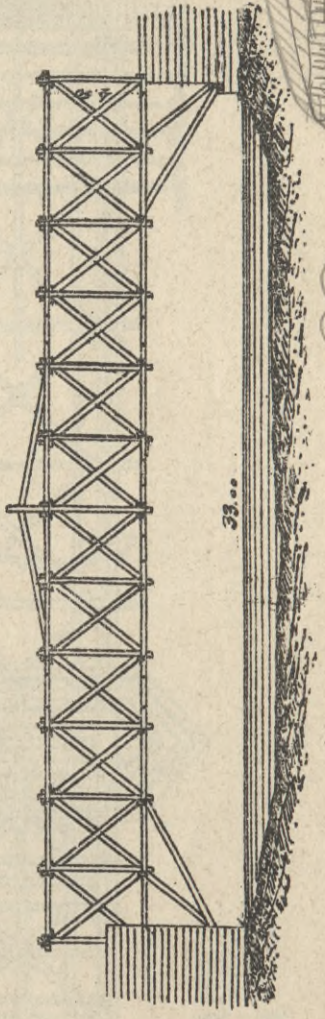

33.00

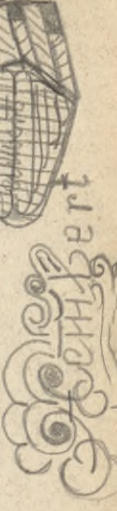

Most syst. Howe'a na rzece Aar pod Hinterkappeln.

Rys. 2a. Przekroj podkowy i widok.

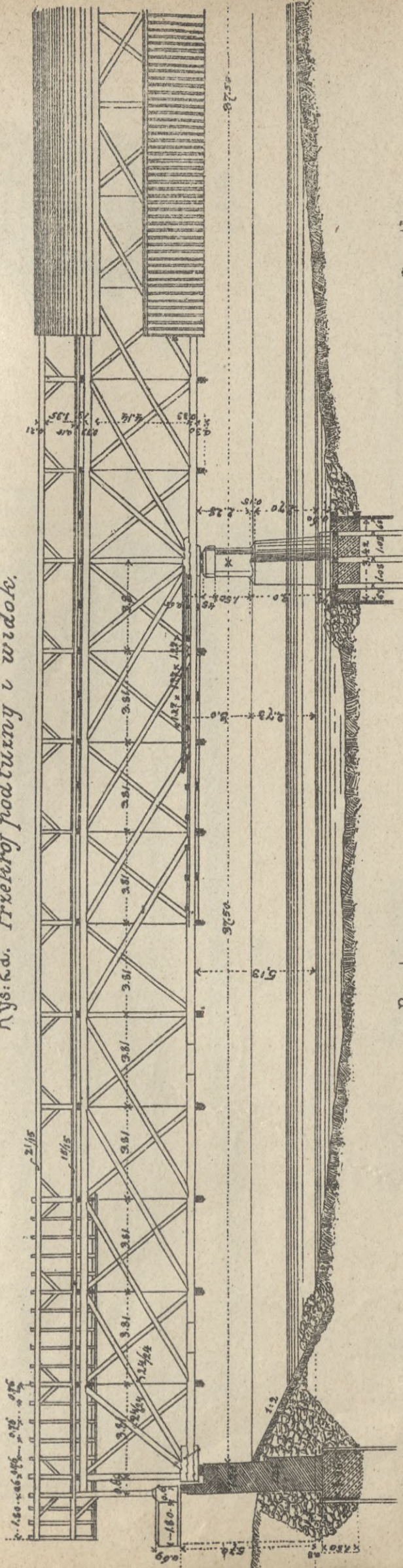

Rys. 1a.

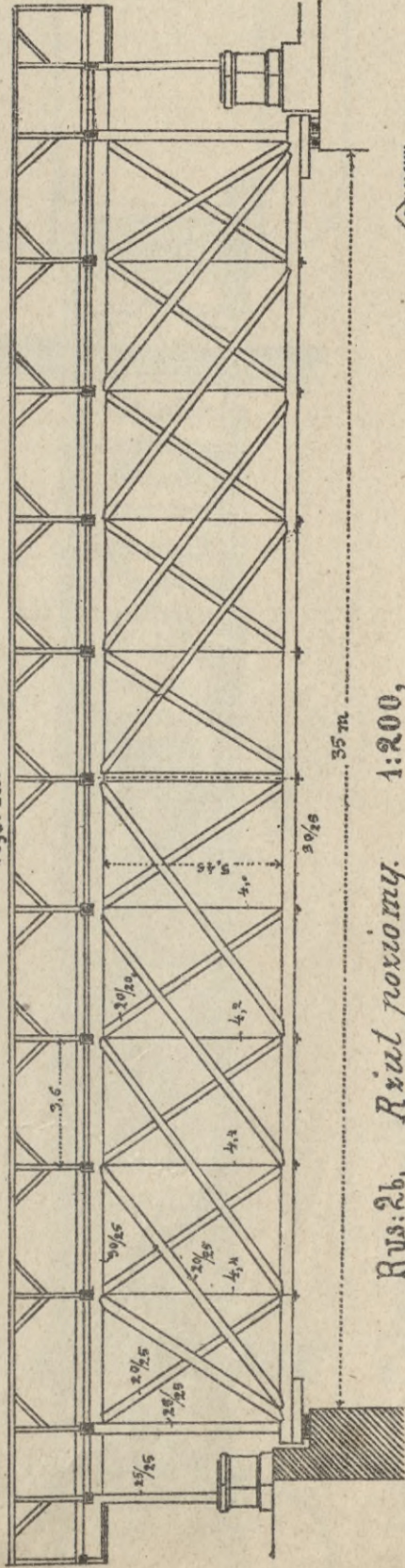

Rys. 2b. Rzut poziomy. 1:200,

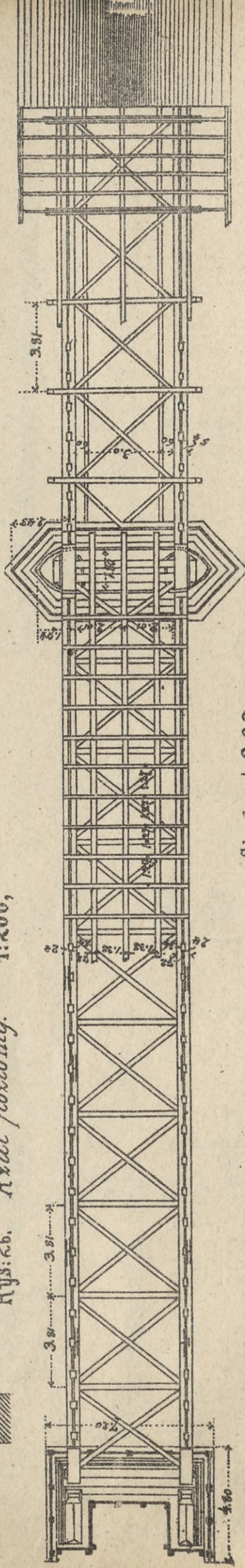

Skala 1:200.

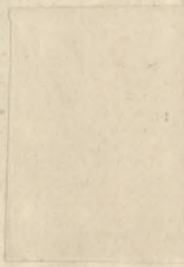
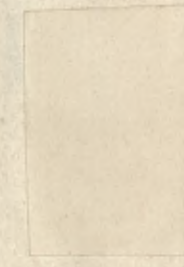
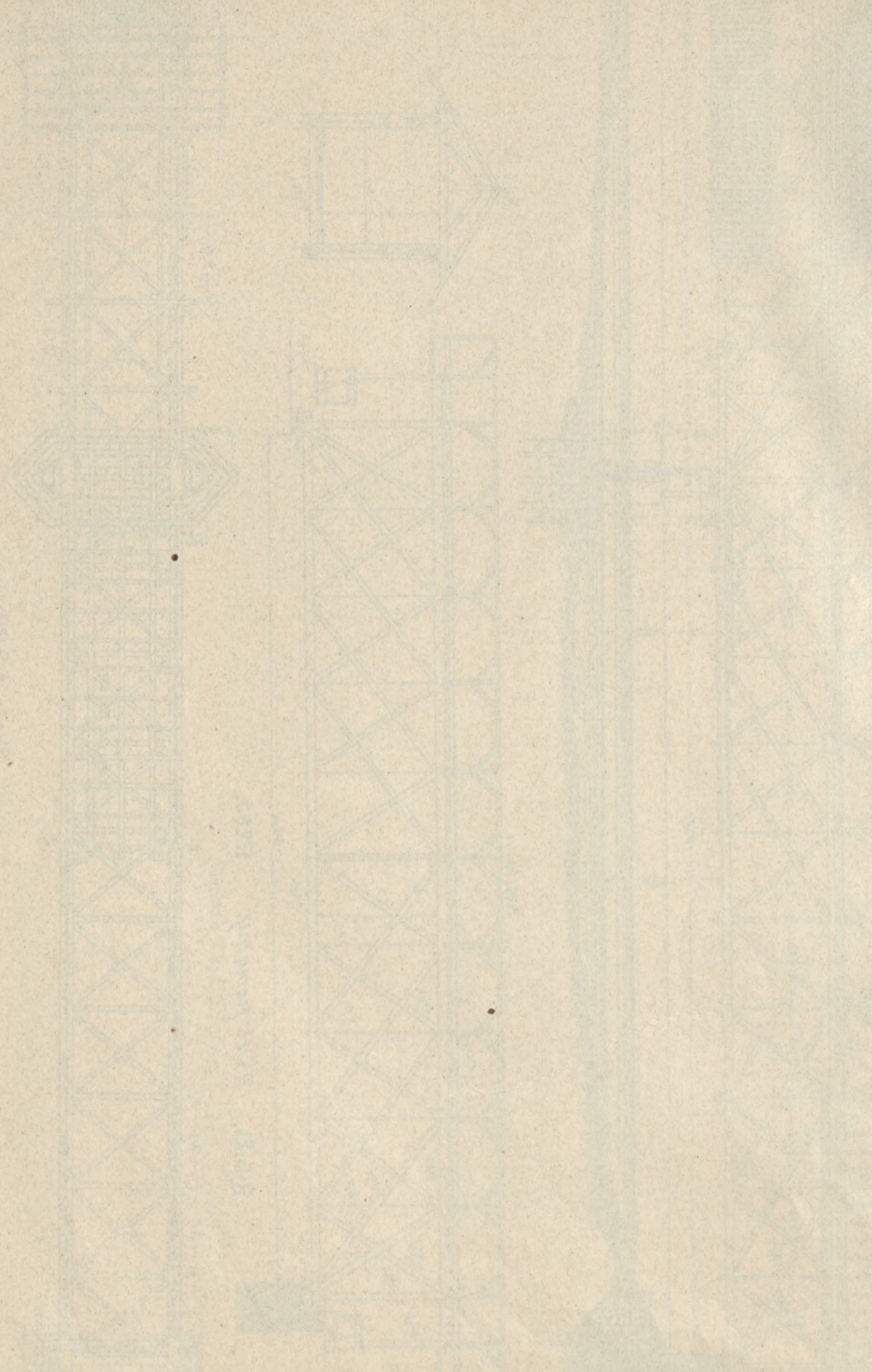

Rys. 1a Widok i przekroj podłużny.

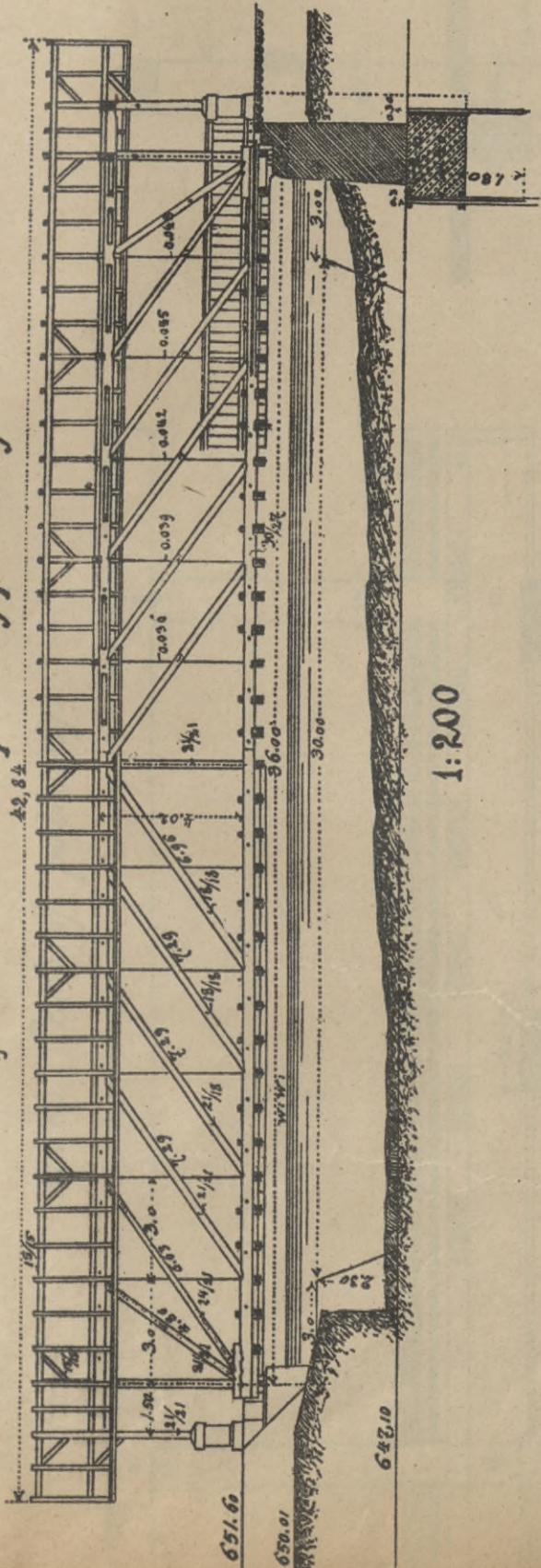

Rys. 1c. Przekroj poprzeczny.

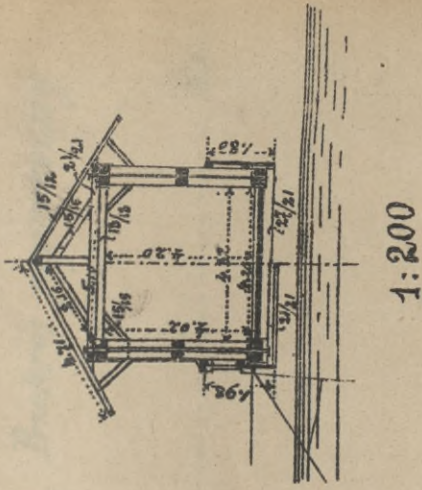

Rys. 1b. Rzut poziomy.

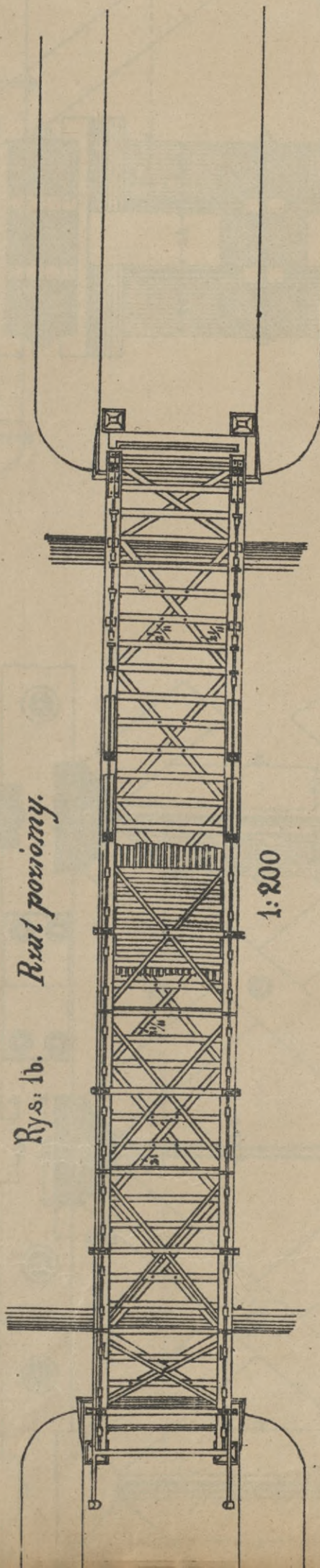

Rys. 2 Zetknięcie w dolnym pasie.

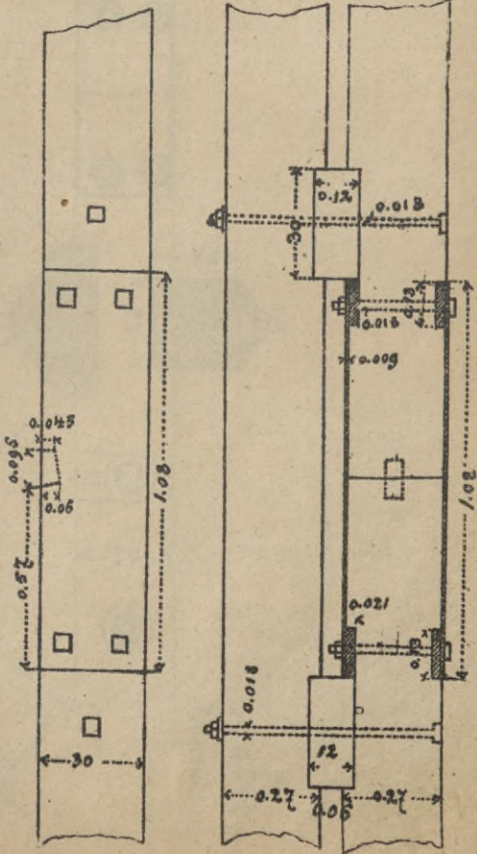

Rys. 3. Zetknięcie w górnym pasie.

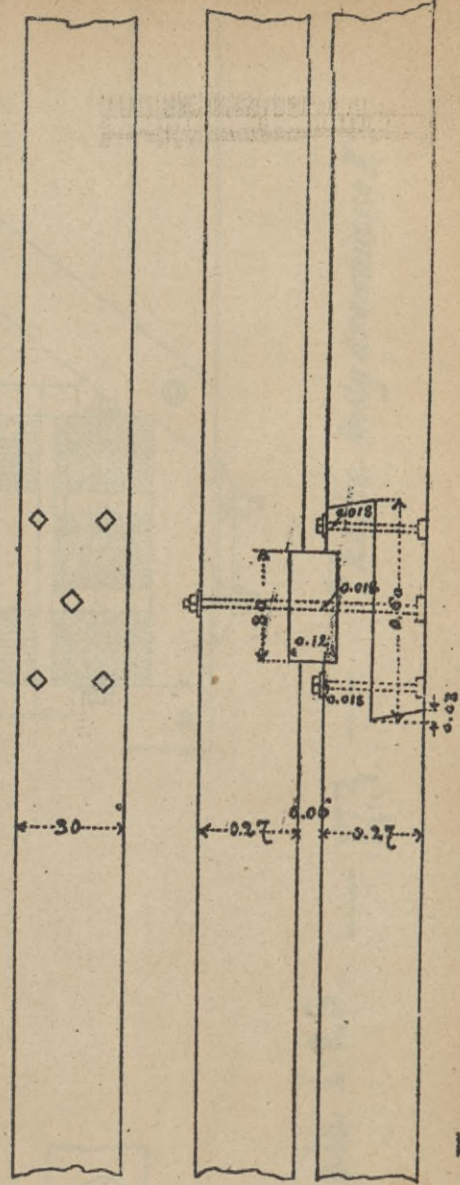

Skala

1:20

174

Rys. 1a Przekrój podłużny.

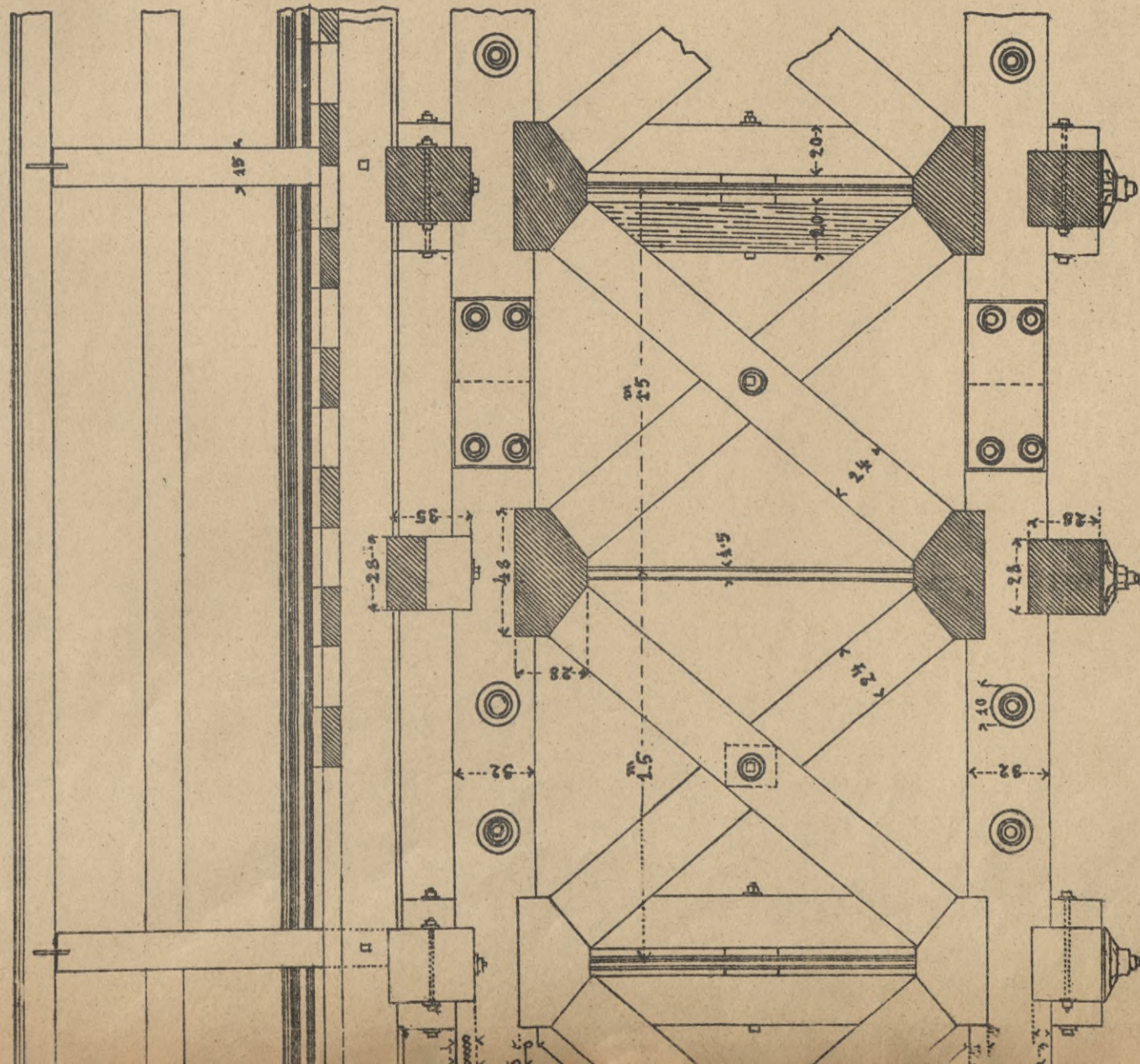

Rys. 1b. Przekrój poprzeczny

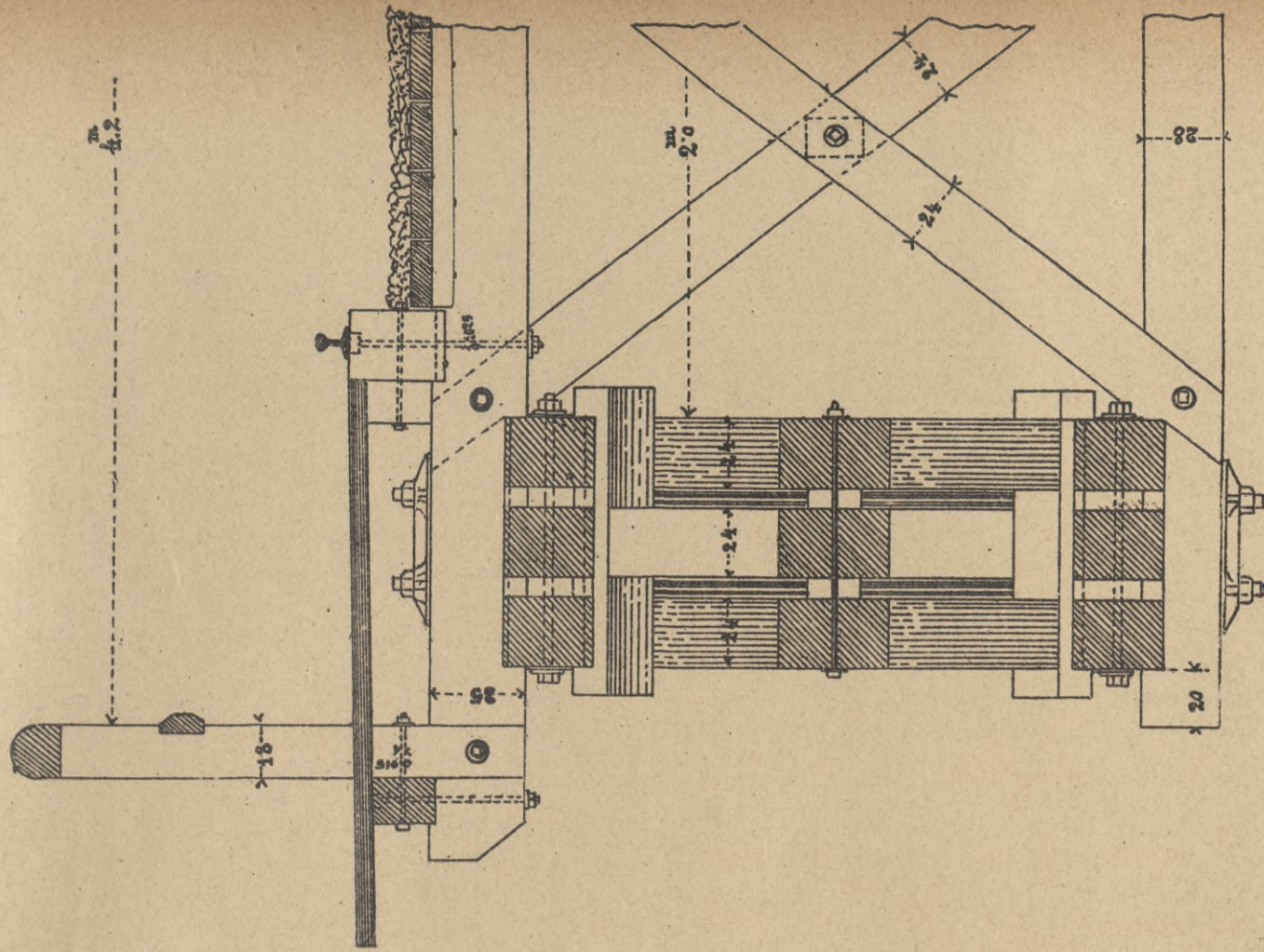

Skala 1:25

Rys. 1a. Widok i przekrój podłużny.

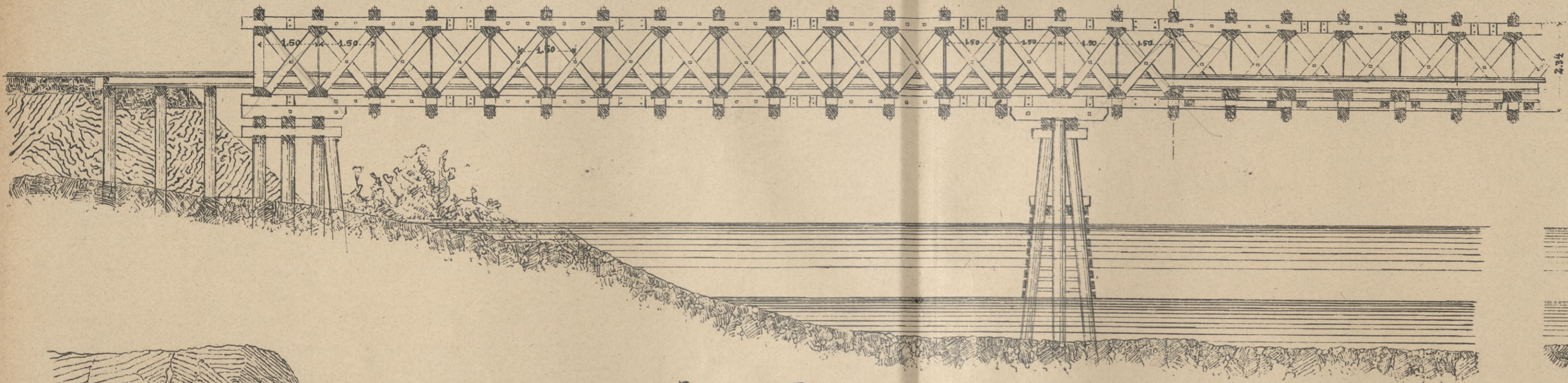

Rys. 1c. Przekrój poprzeczny

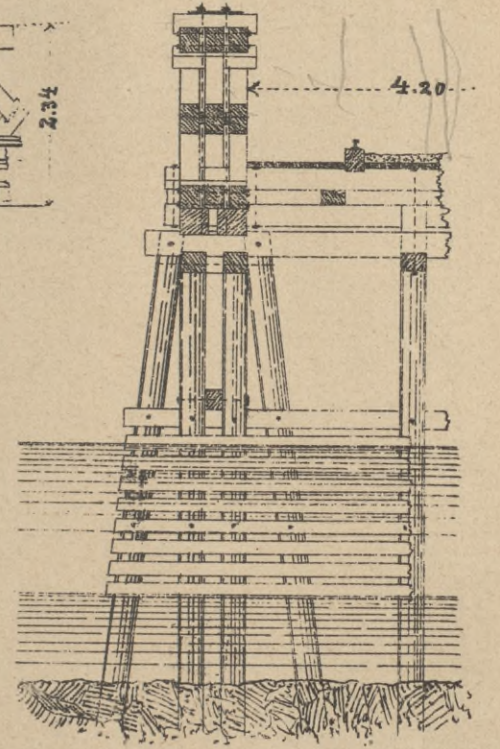

Rys. 1b. Rzut poziomy

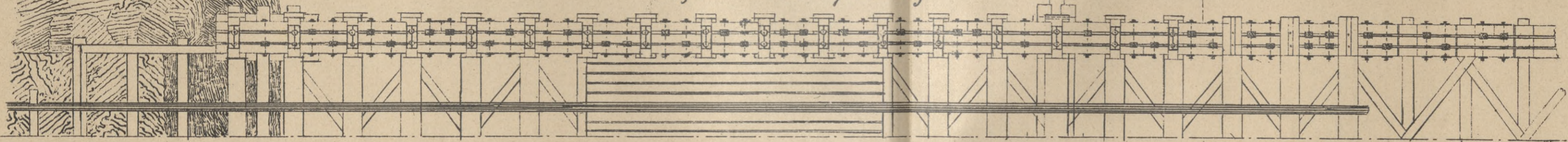

1:100

Rys. 2b. Przekrój poprzeczny.

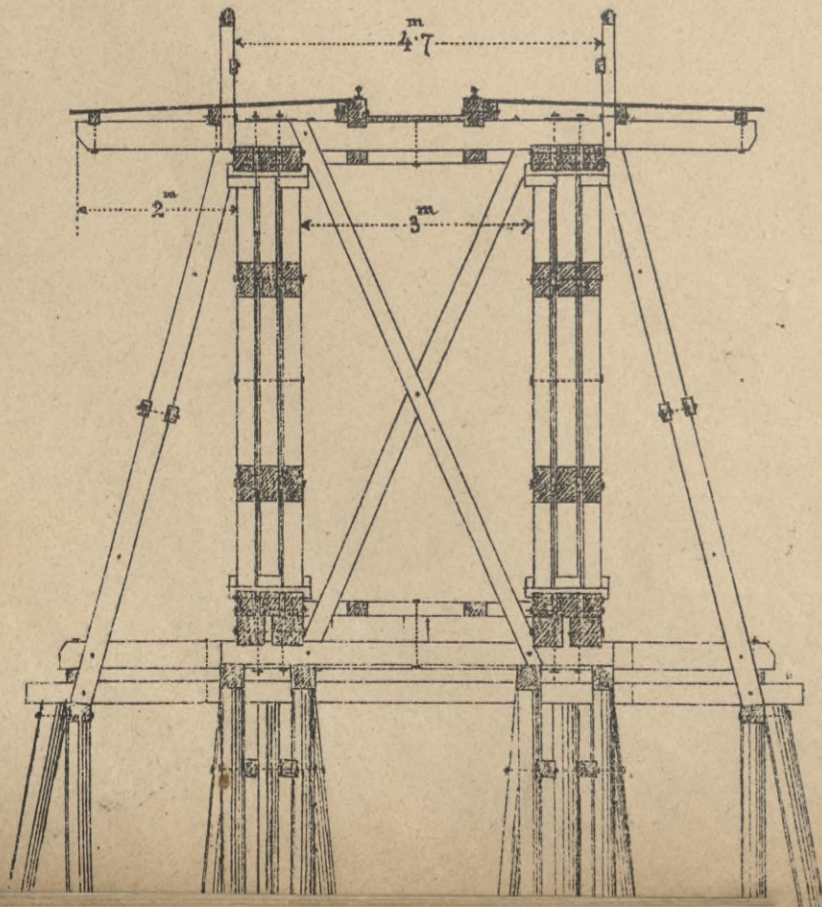

Rys. 2a. Przekrój podłużny i widok.

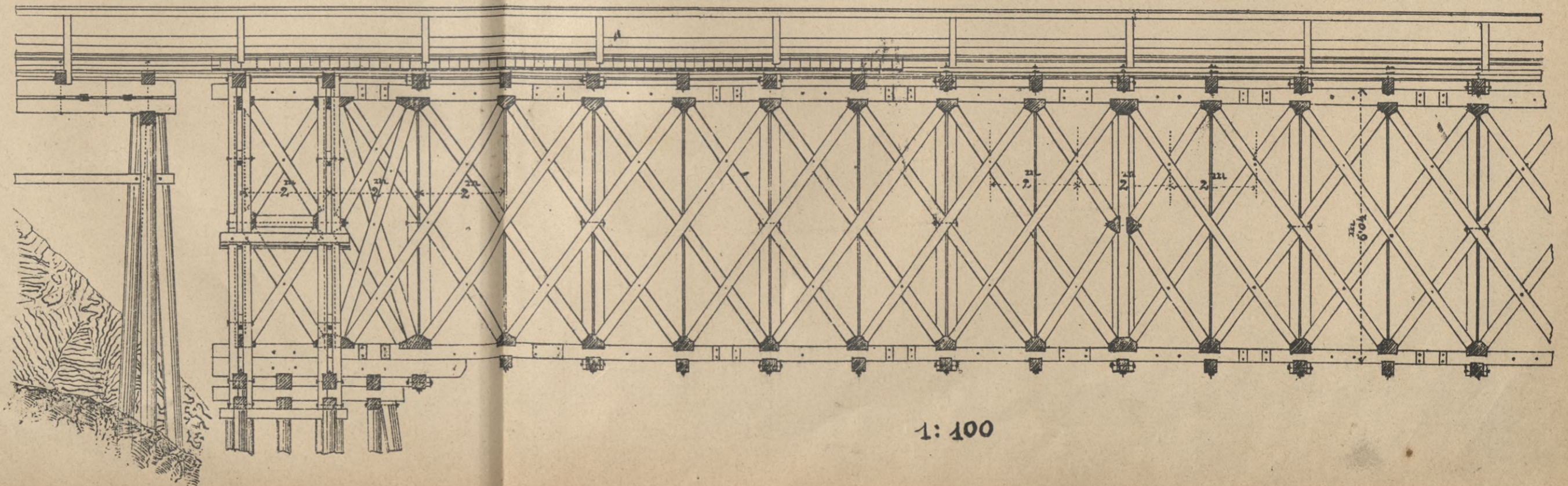

1:100

Belka Howe'a o rozpiętości 54.86 metr.

Rys. 1

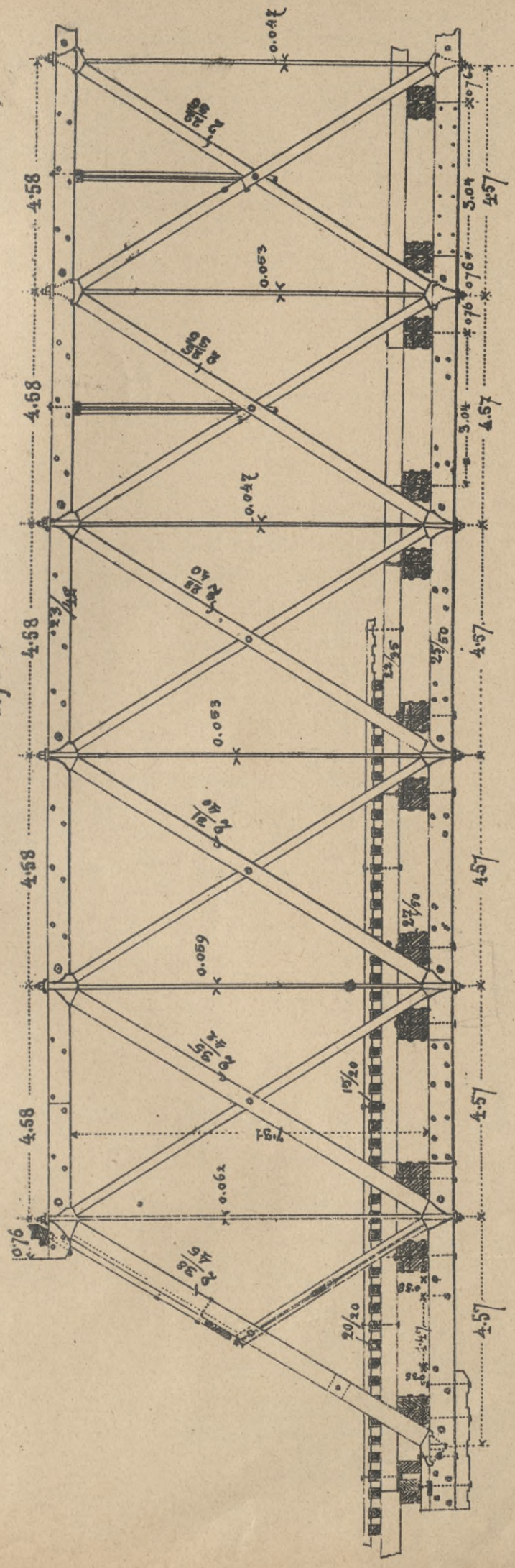

1:111

Rys. 2.

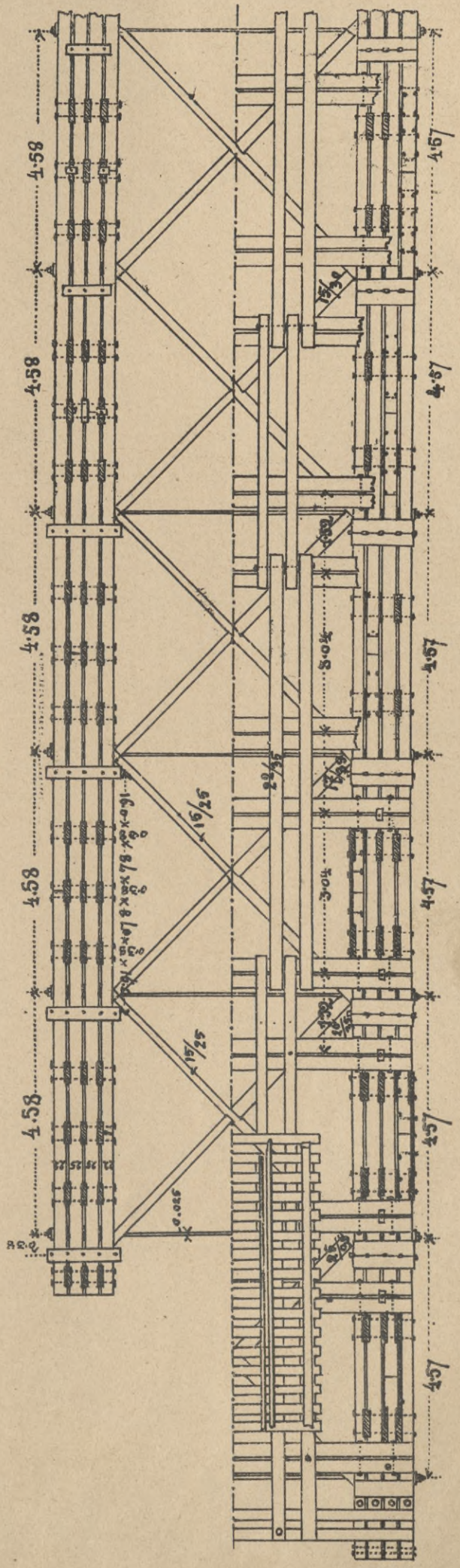

1:111

Most drewniany kolei amerykańskiej zachodniej

Tabl.

Rys. 1 Przekrój poprzeczny

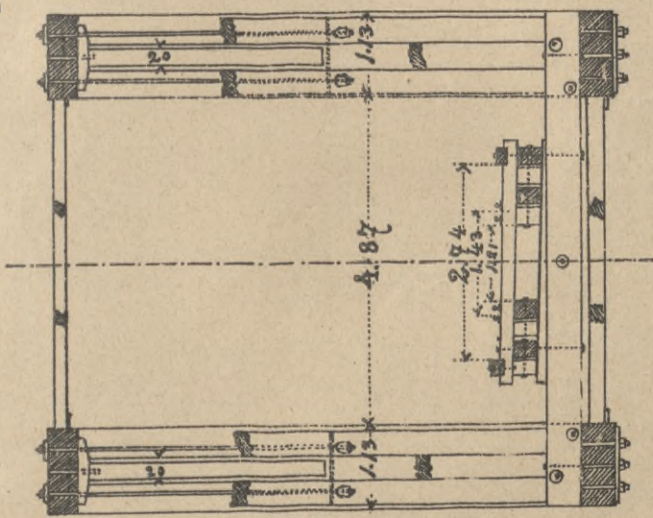

1:100

Rys. 2 Przekrój poprzeczny

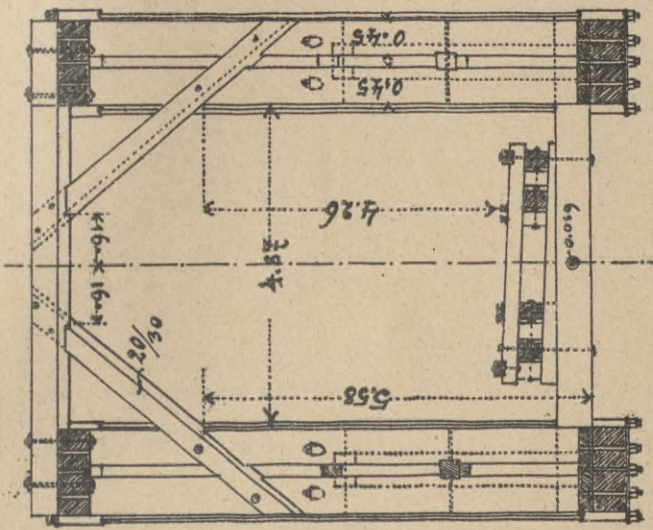

1:100

Rys. 3 Trzewik bocowy.

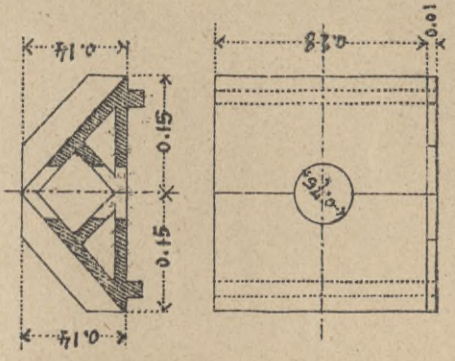

1:10

Rys. 4 Trzewik.

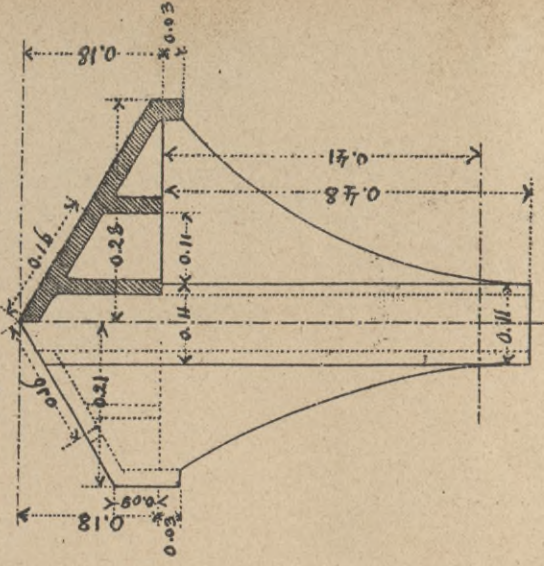

1:10

Rys. 5 Zetknięcie pasu.

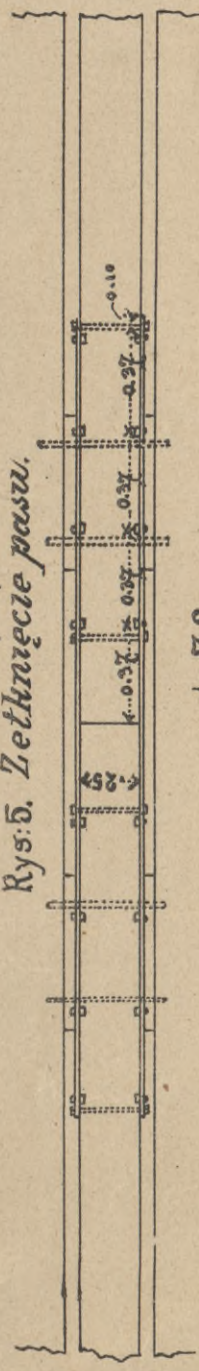

1:32

Rys. 6 Przykładka drewniana.

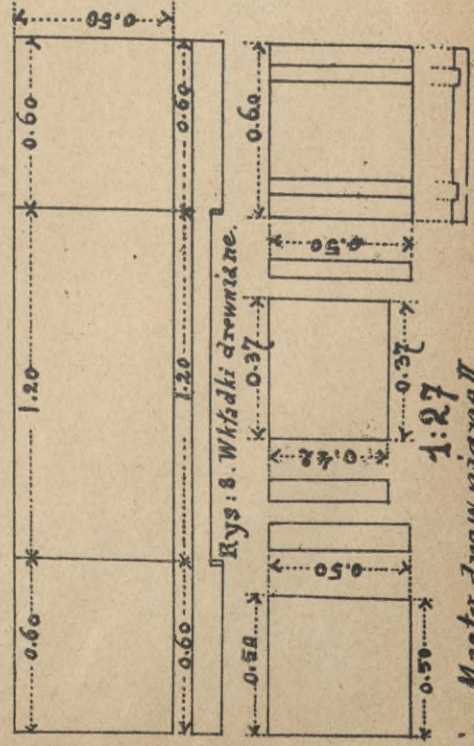

1:27

Rys. 7 Sukie belki głównej.

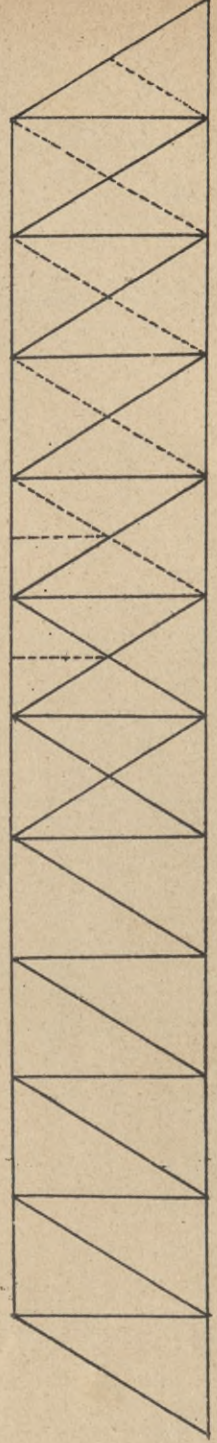

1:300

Mosty kolejowe.

Rys: 1. Most norweskki

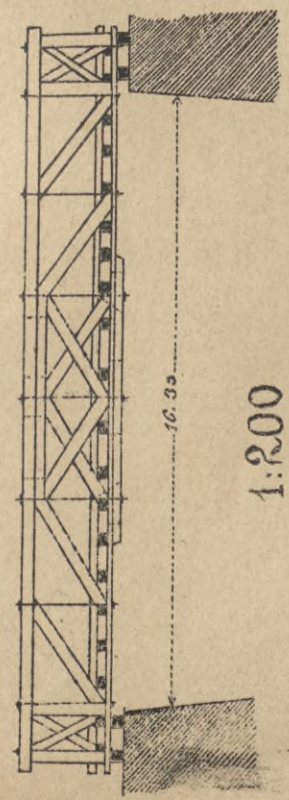

1:200

Most przewidywany na Renie pod Kehl

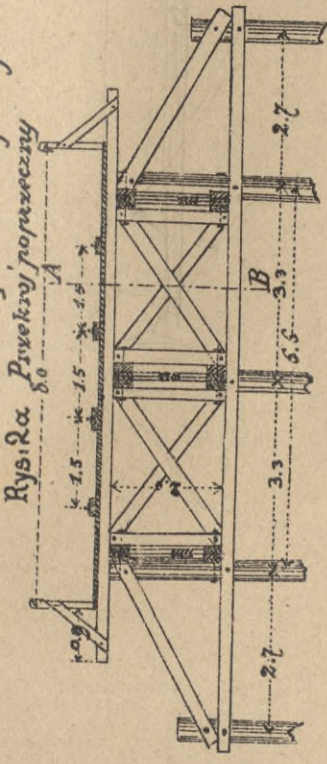

Rys: 2a. Przekroj poprzeczny

Rys: 2b. Przekroj AB.

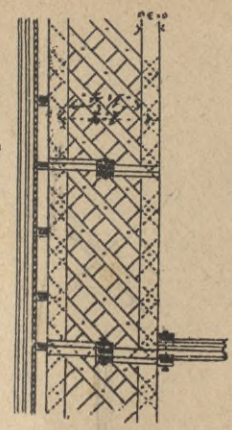

Most na rzece Tennessee Rys: 3a. Widok

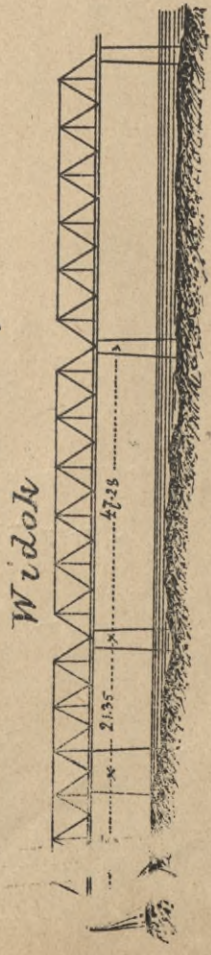

1:1200

Rys: 3b

Górny węzeł

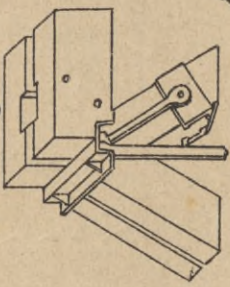

Rys: 3c

Dolny węzeł.

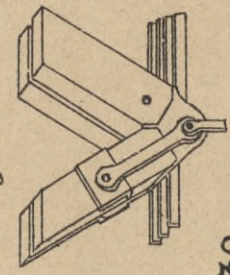

1:50

Most na Duraju pod Erbach

Rys: 4b Przekroj poprzeczny.

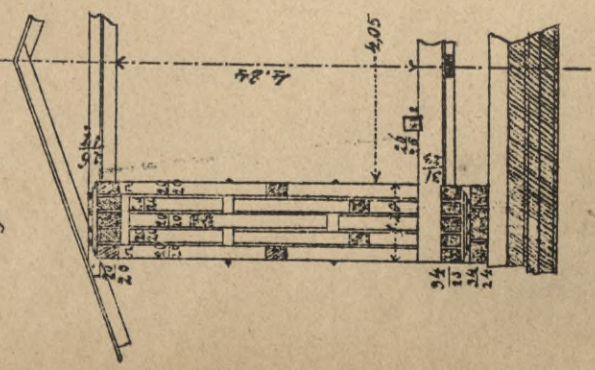

1:125

Rys: 4a. Widok

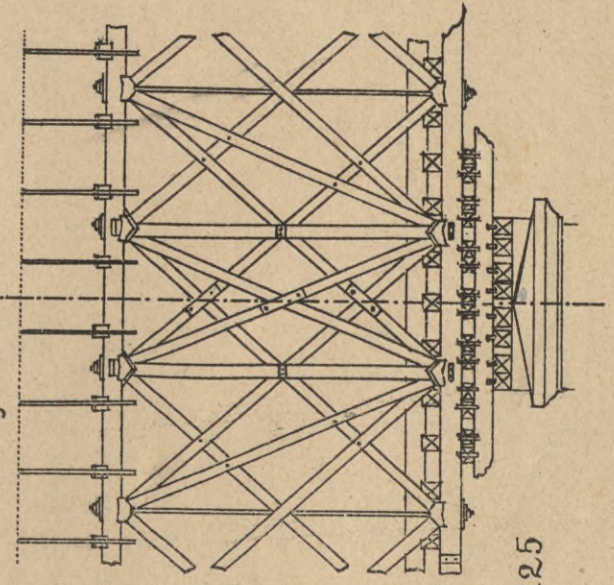

Belka Post'a

Rys: 5a. Widok.

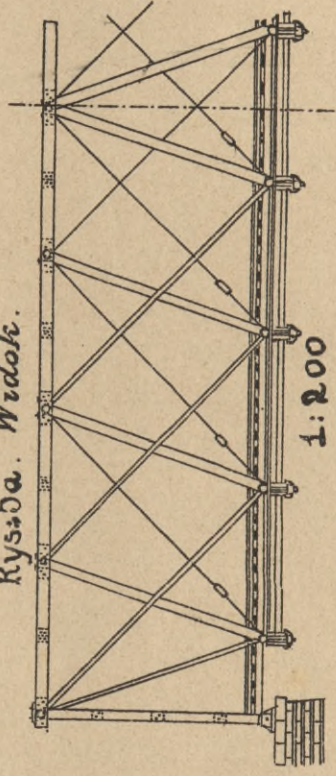

1:200

Rys: 5b. Krut poziomy.

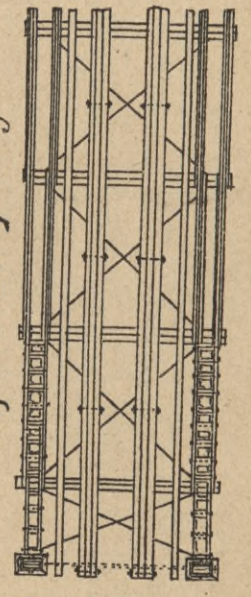

1:200

Rys: 4c. Górny węzeł

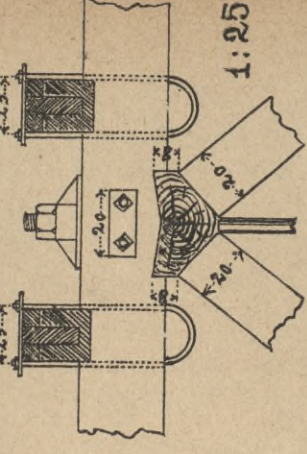

1:25

Rys: 4d. Dolny węzeł

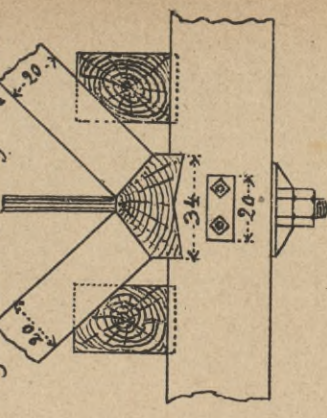

Rys: 5c

Przekroj poprzeczny.

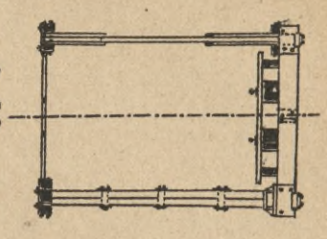

Most kolei węg. wschodniej na rzece Aranyos.

Tab. 24.

Rys. 1 Widok.

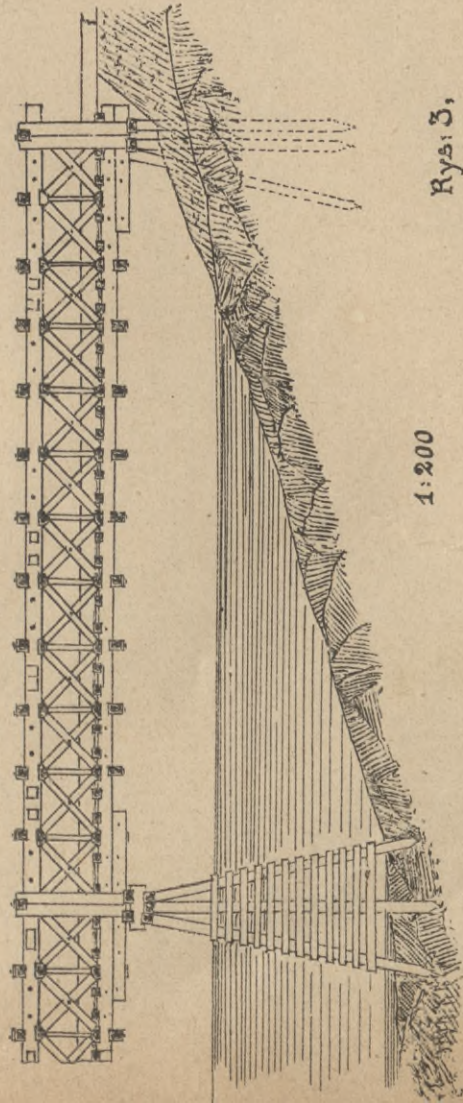

Rys. 2,

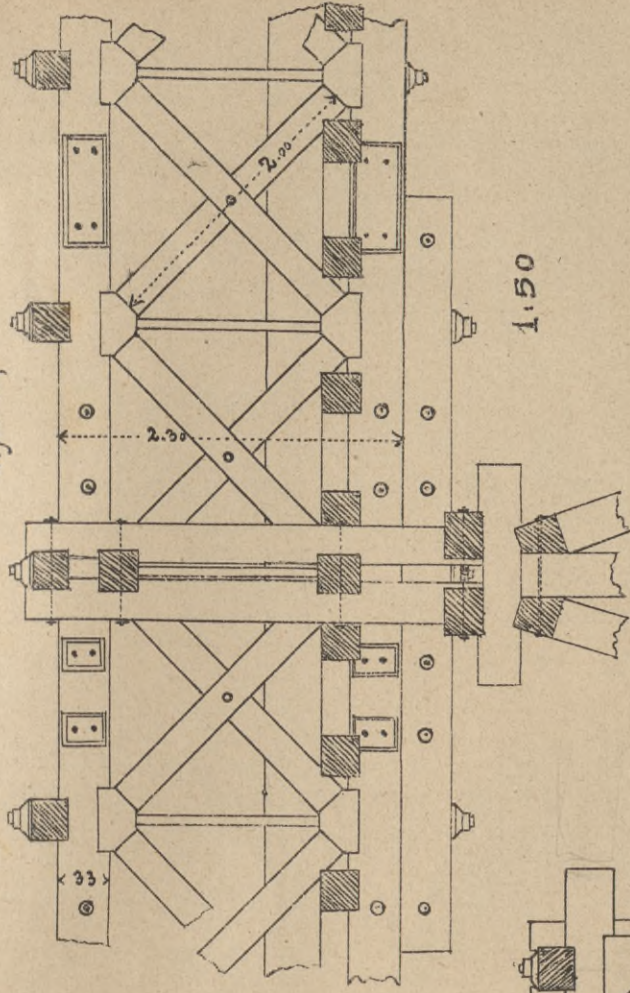

1:200

Rys. 3,

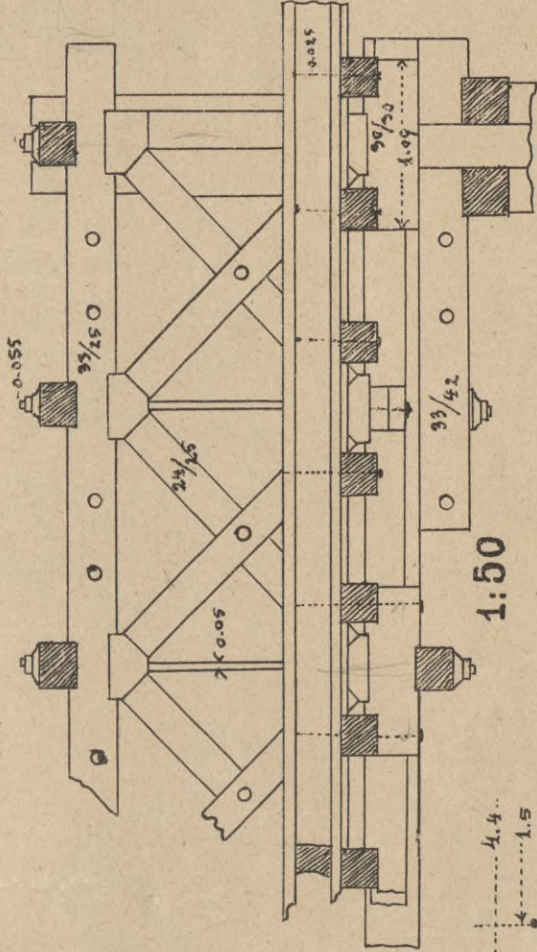

1:50

Rys. 4

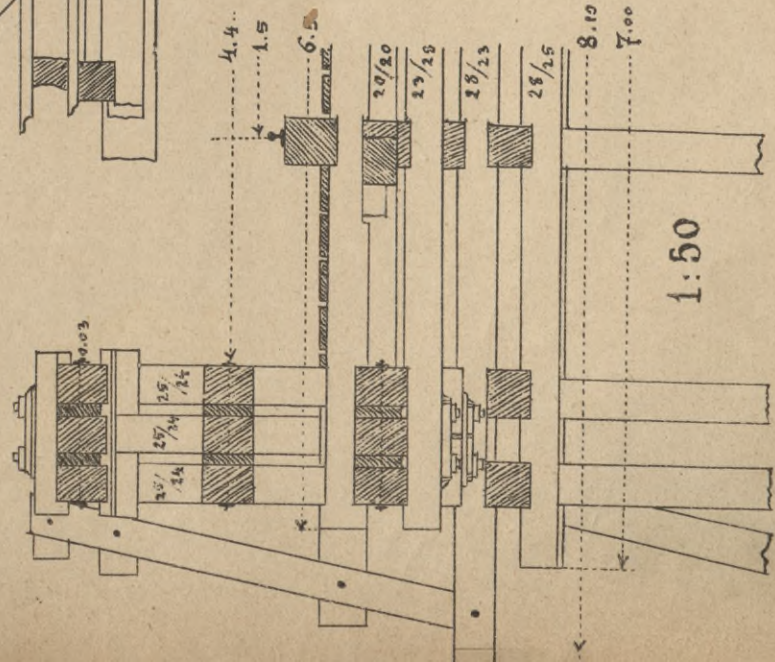

1:50

Rys. 5,

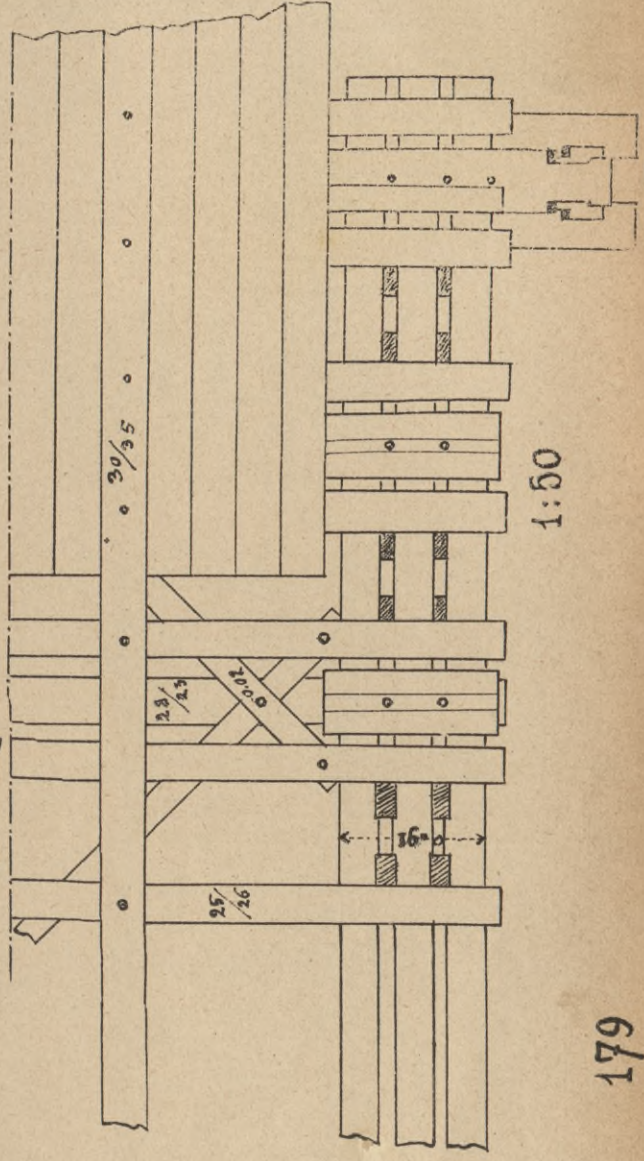

1:50

Rys. 1a. Widok.

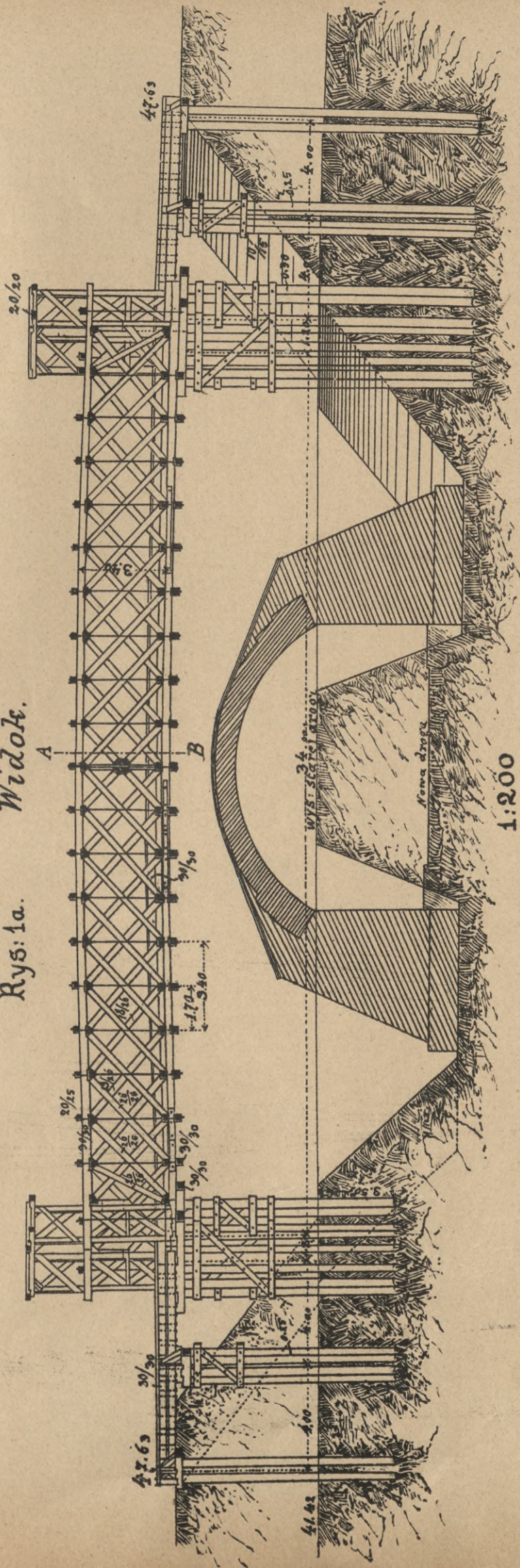

Rys. 1b. Rzut poziomy

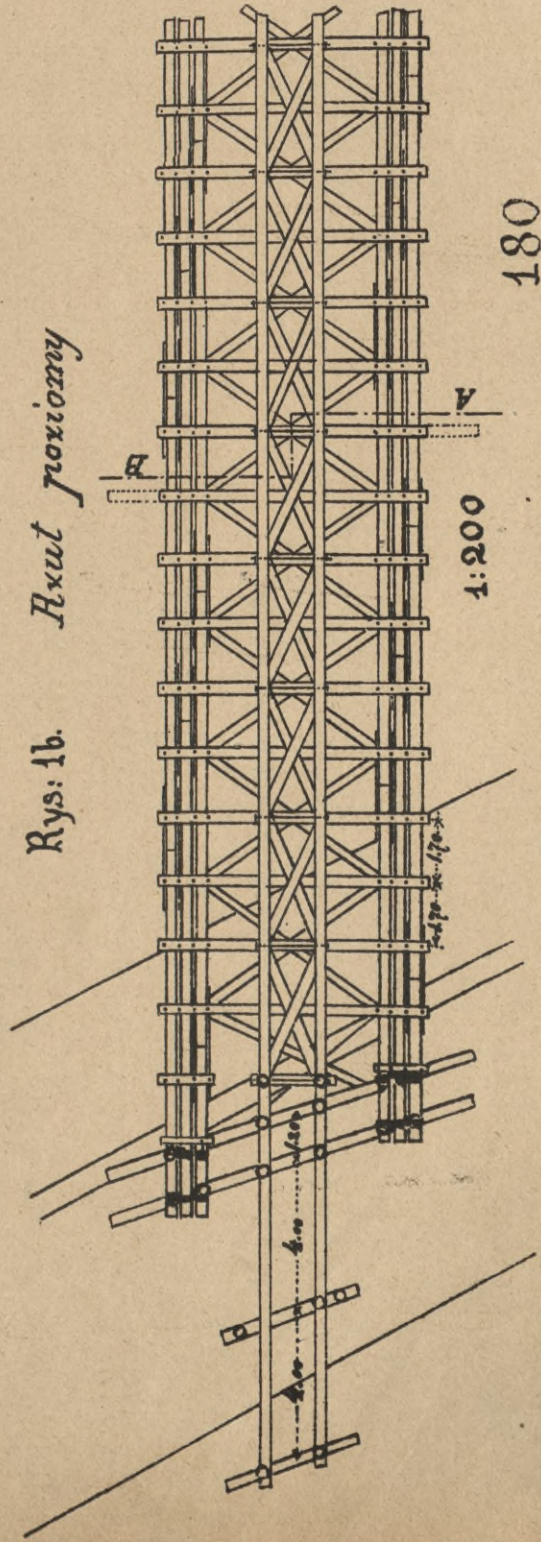

Rys. 1c. Przekrój A-B

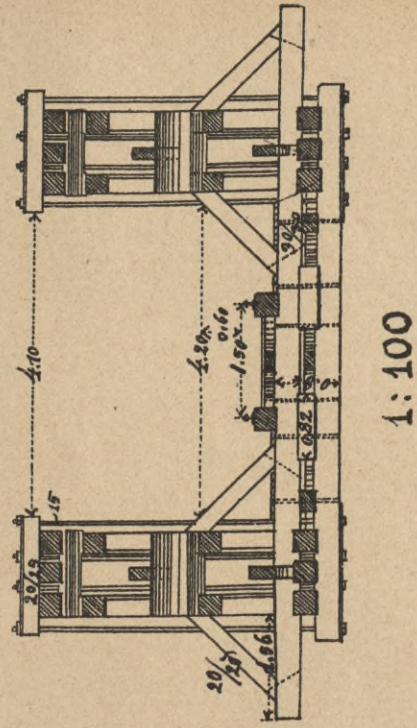

Rys. 1

Most tymczasowy pod Hollman.

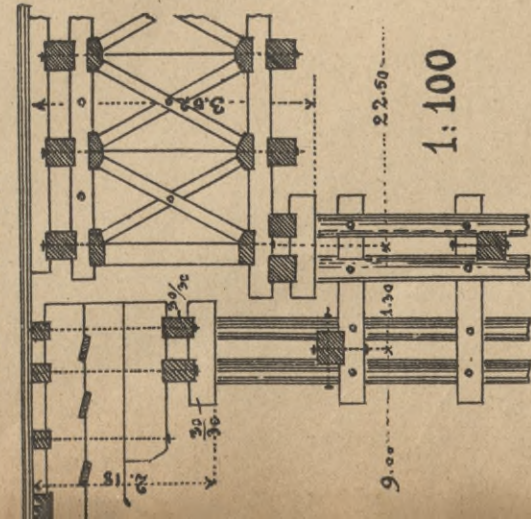

Rys. 2a. Przekrój

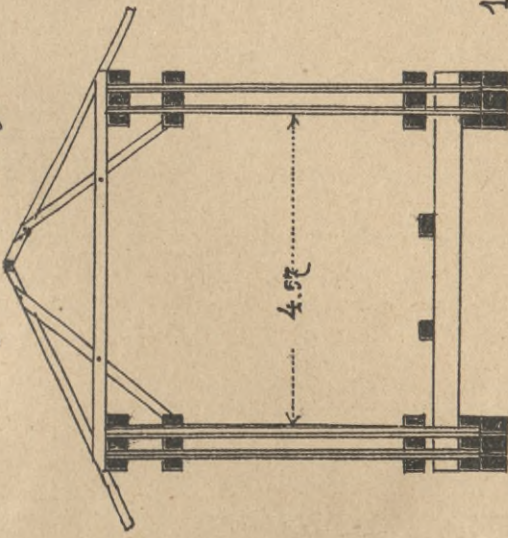

Most amerykański Towna i Howe'a Rys. 2b.

Widok.

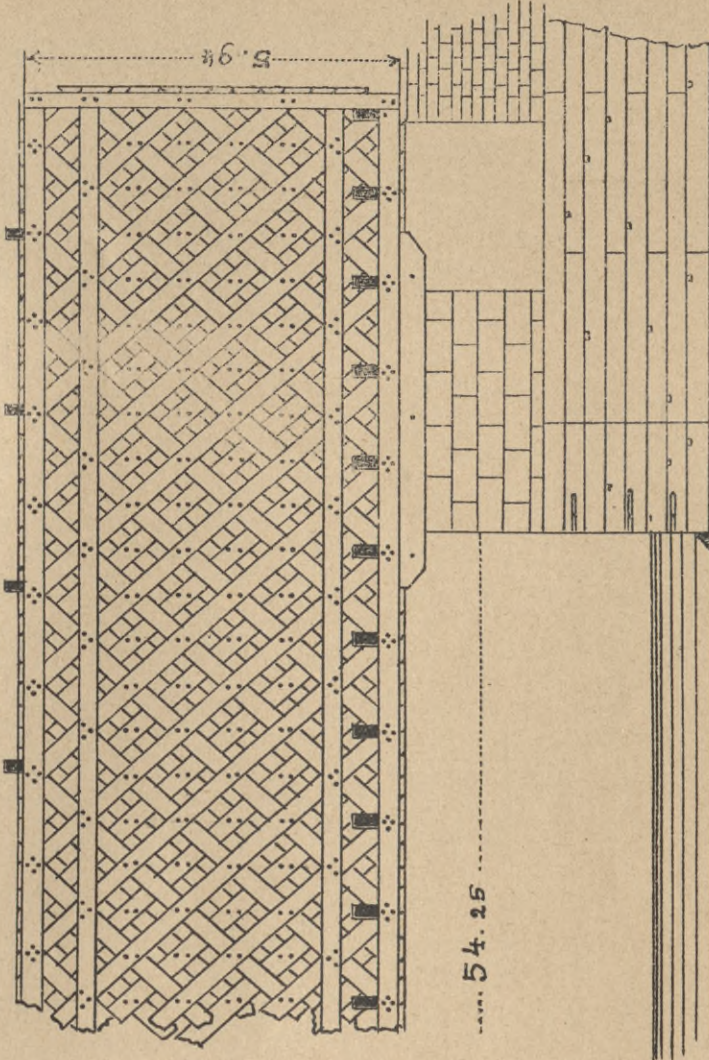

54.25

Szczegół węzła dolnego Rys. 3c

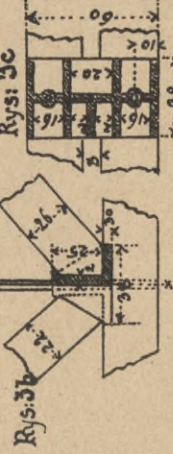

Rys. 3a. Most na Weltaire w Pradze Widok.

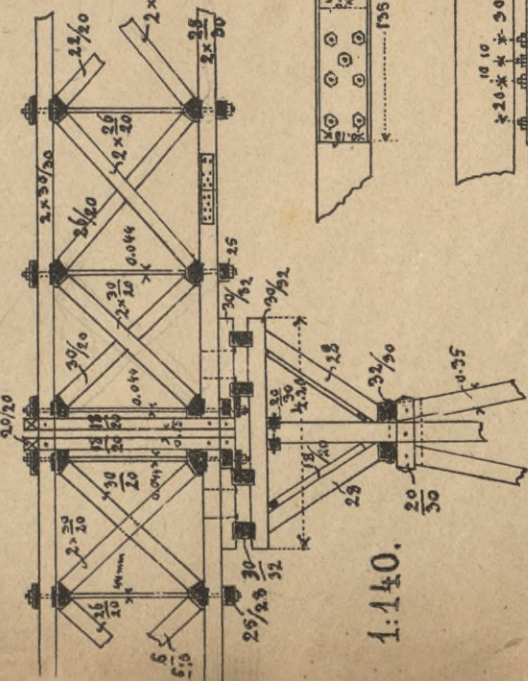

Rys. 3d. Szczegół w pasie dolnym

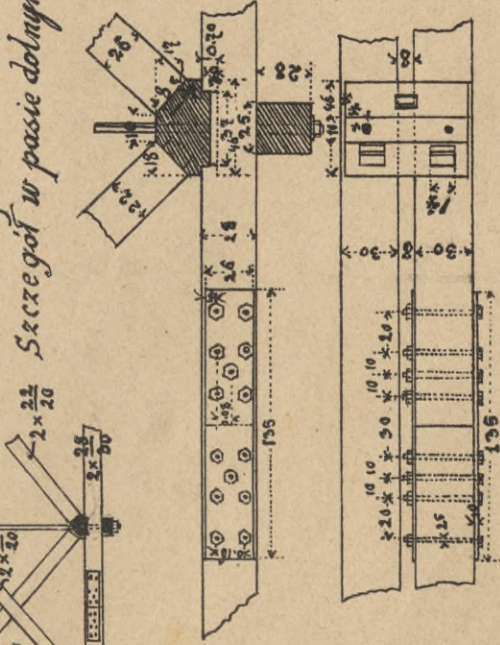

Rys. 2c Przekrój.

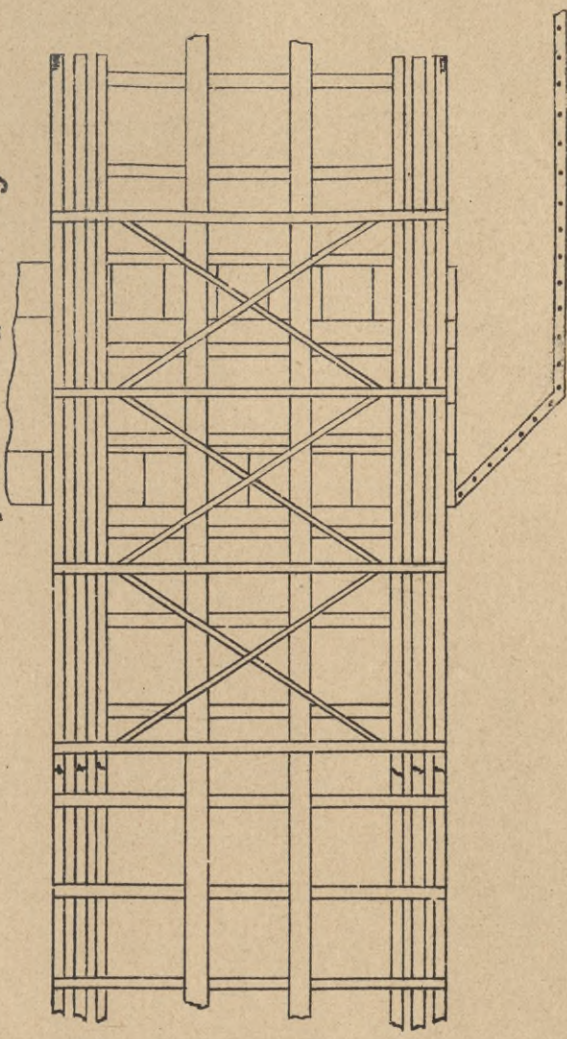

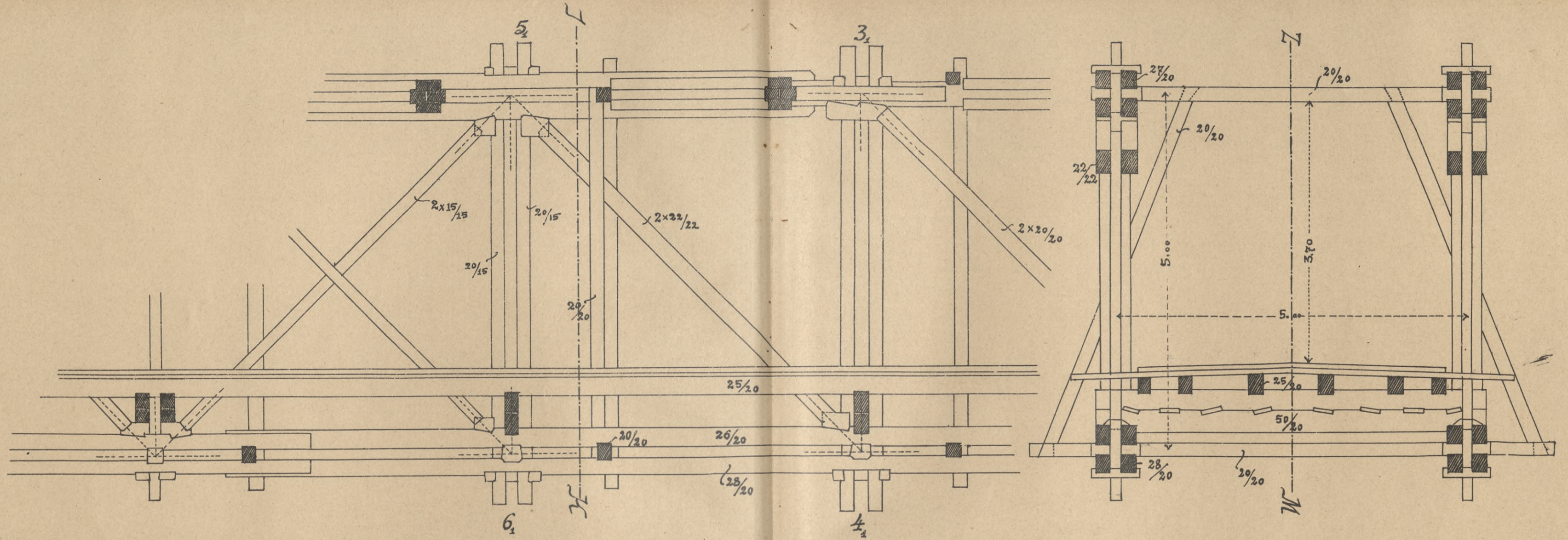

Rys poziomy.

Most drogowy

układu

RYCHTERA

Skala, 1:50,

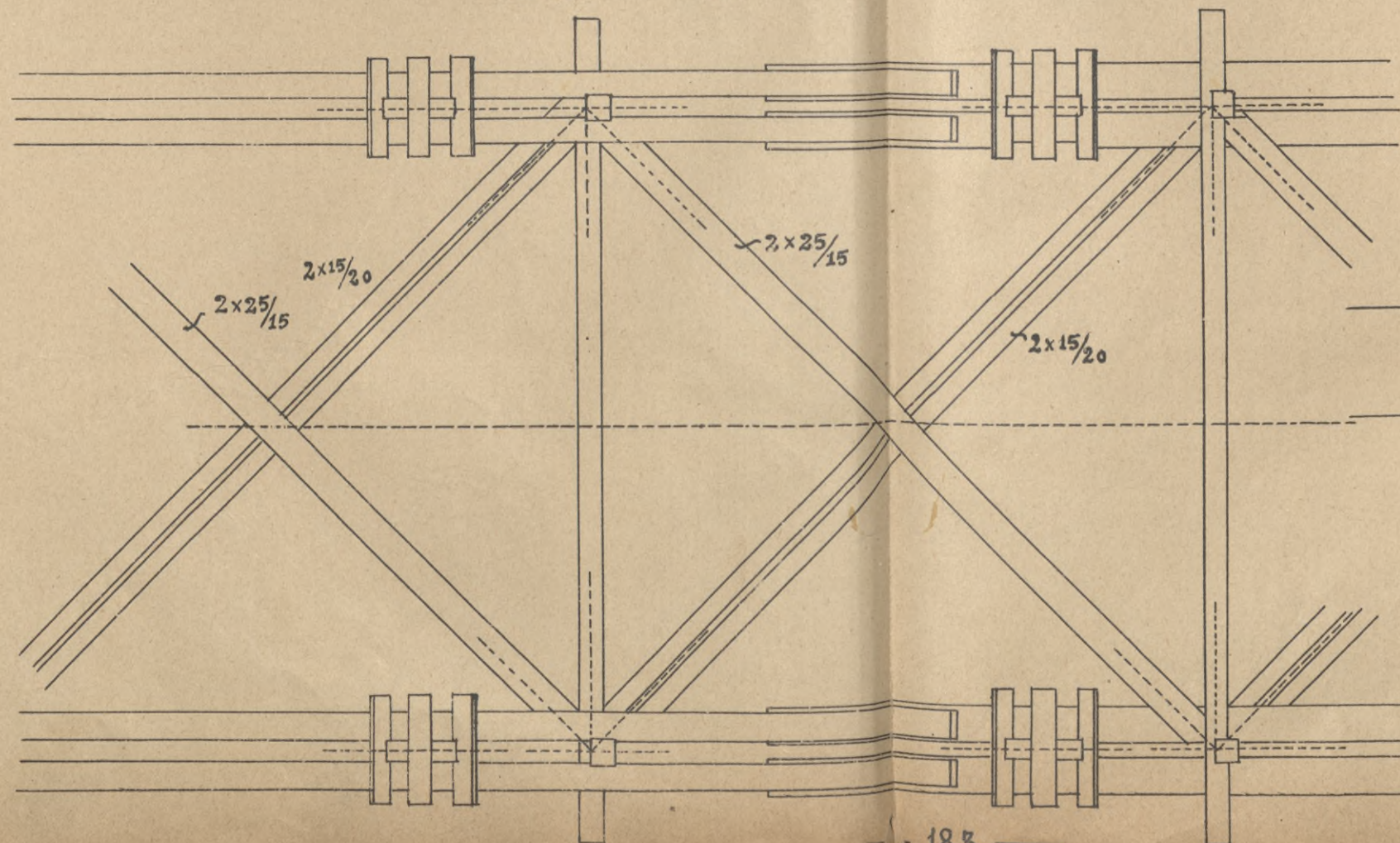

Szczegół połączenia dolnego pasa $\frac{1}{20}$ n:w:

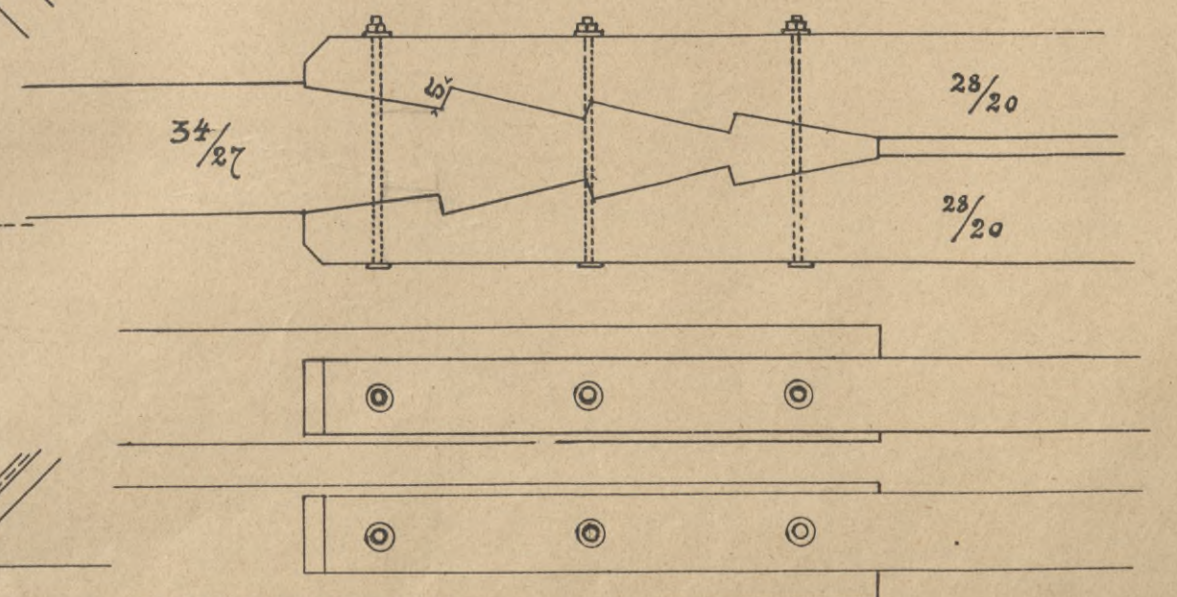

układu Pintowskiego.

Rys. 2,

Styki belek pasu górnego.

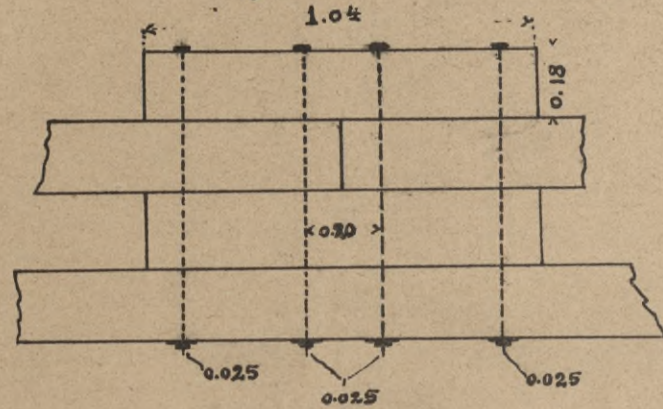

Rys. 1b,

Przekrój c d
(brata odjęta)

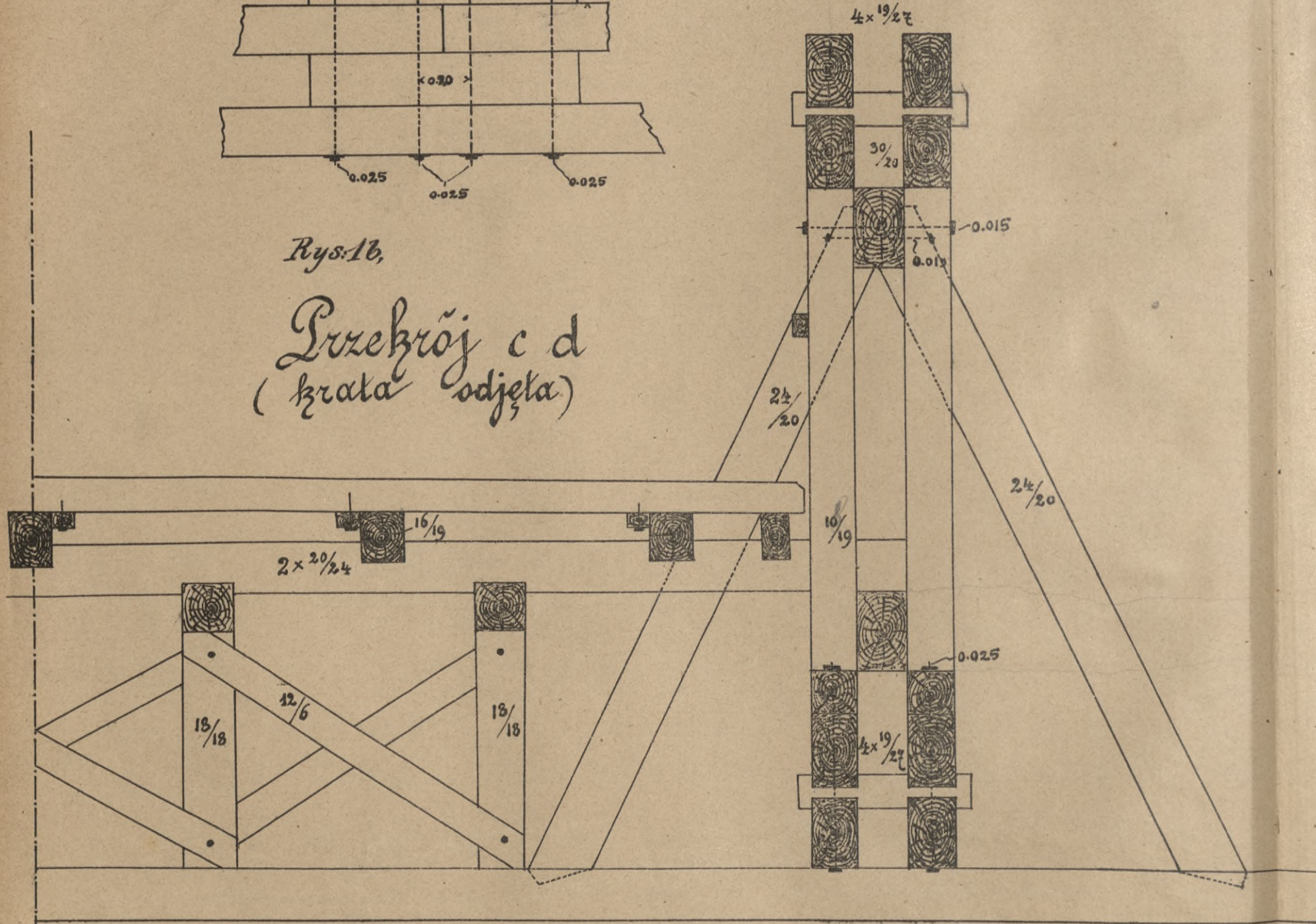

Rys. 1a,

Widok,

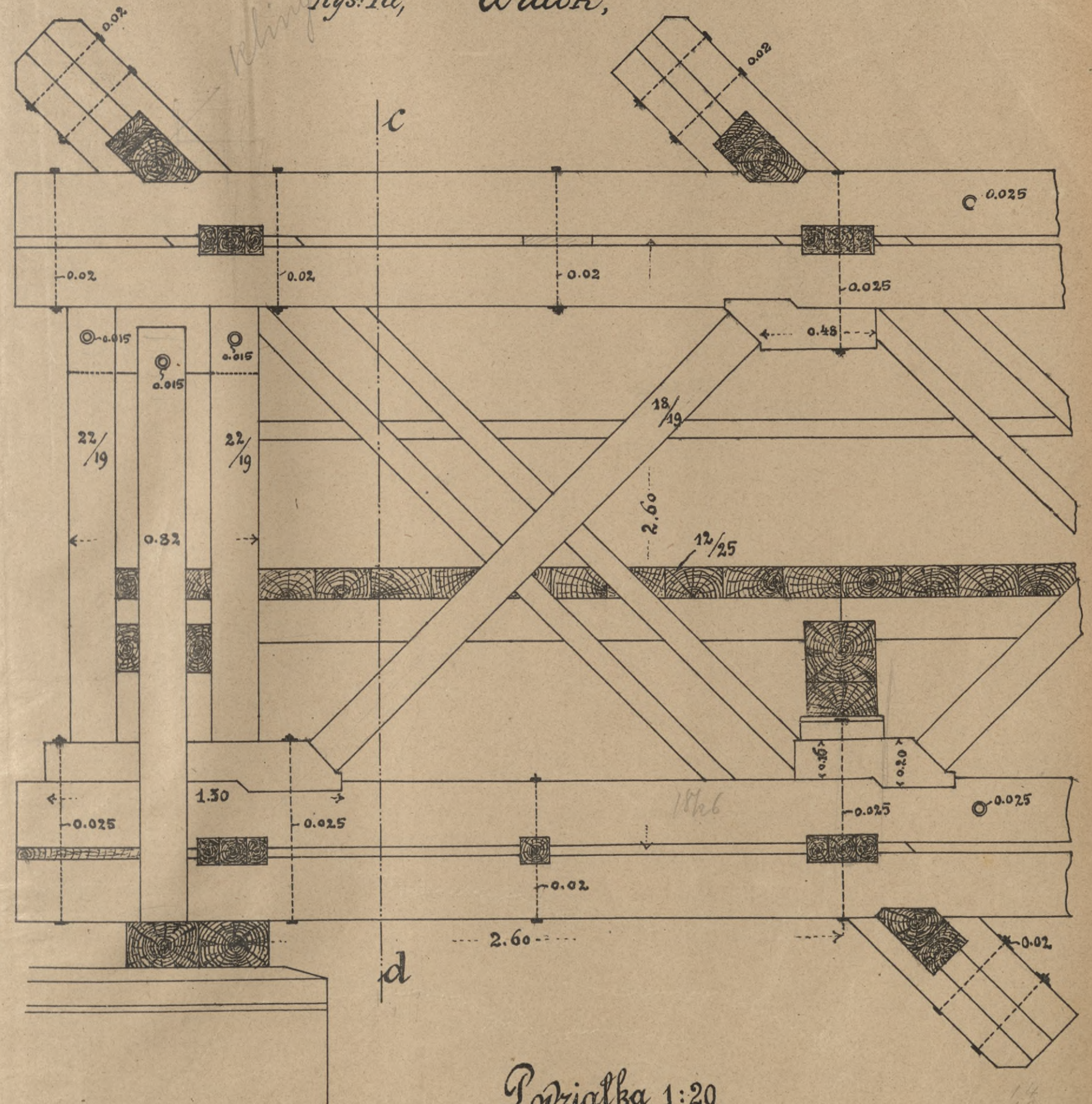

Podziałka 1:20

Długość teor. 25,60 m. Szerokość pom. 5,90 m.
 Wysokość teor. 2,56 m. Szerokość mostu w świetle 6,00 m.

układu Pinlowskiego.

Rys. 2, Szczygół poprzeczny

Rys. 1b

Rys. 1a Widok

Przekrój

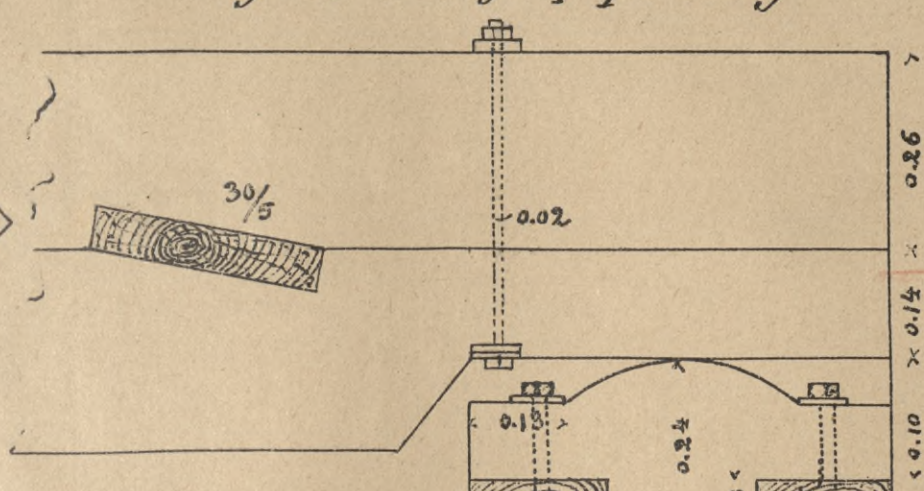
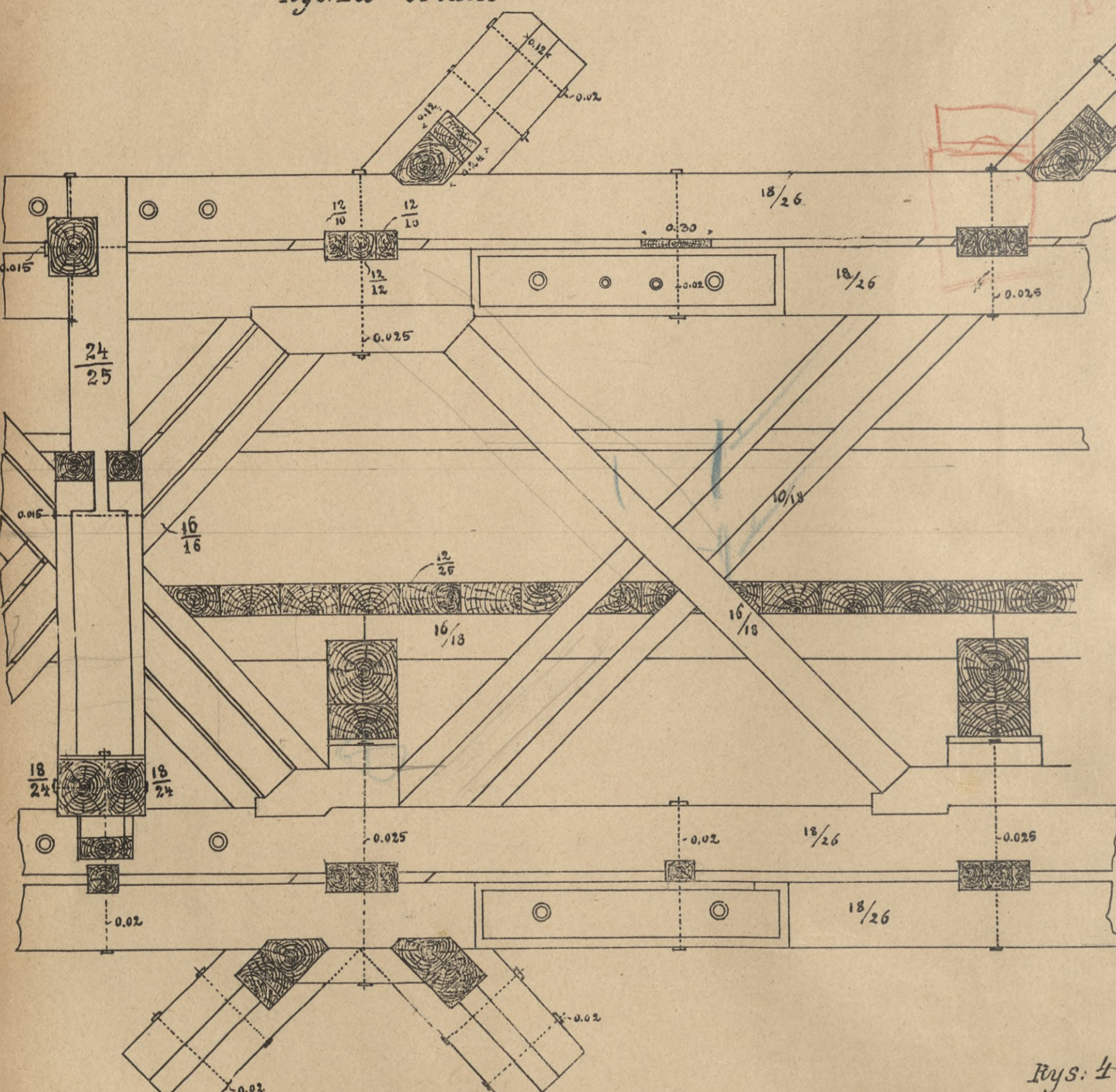

Rys. 3 Styk belek pasu

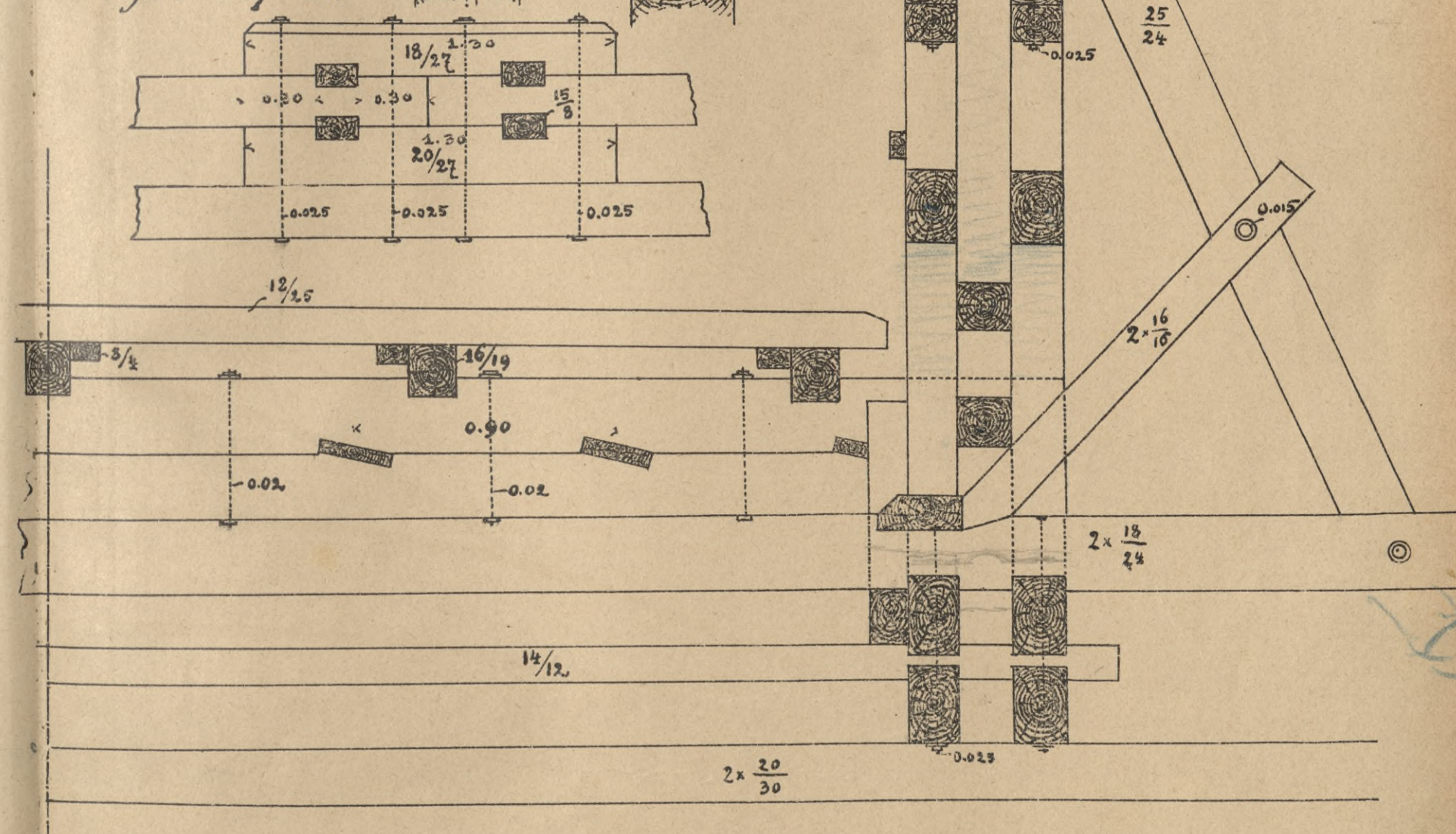

Rys. 4

belka górna	9.82	10.40	7.22
dolna	7.62	9.60	10.22
górna	4.62	10.48	12.34
dolna	12.34	10.08	5.02



Rys. 1, Przekroj podłużny

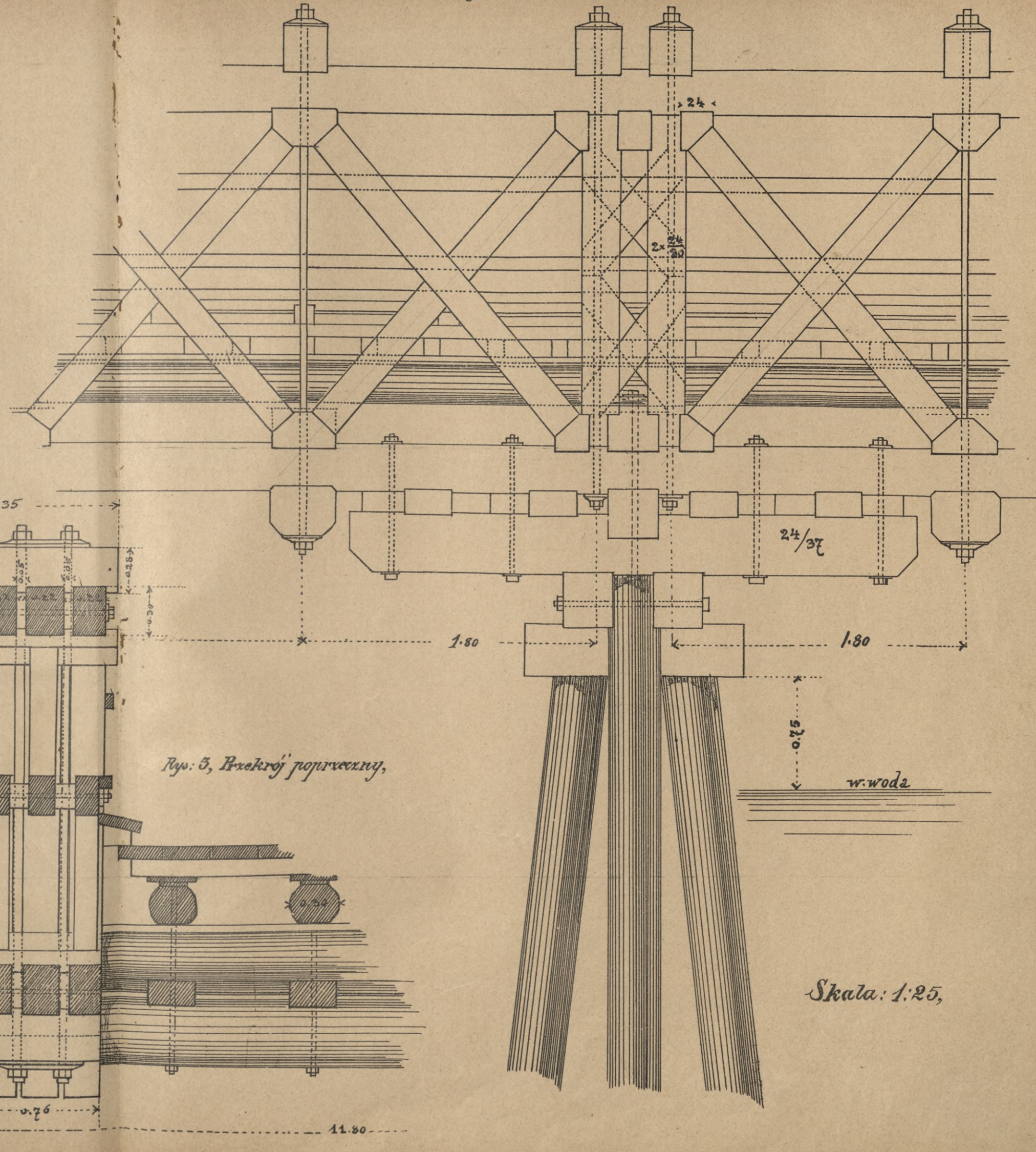
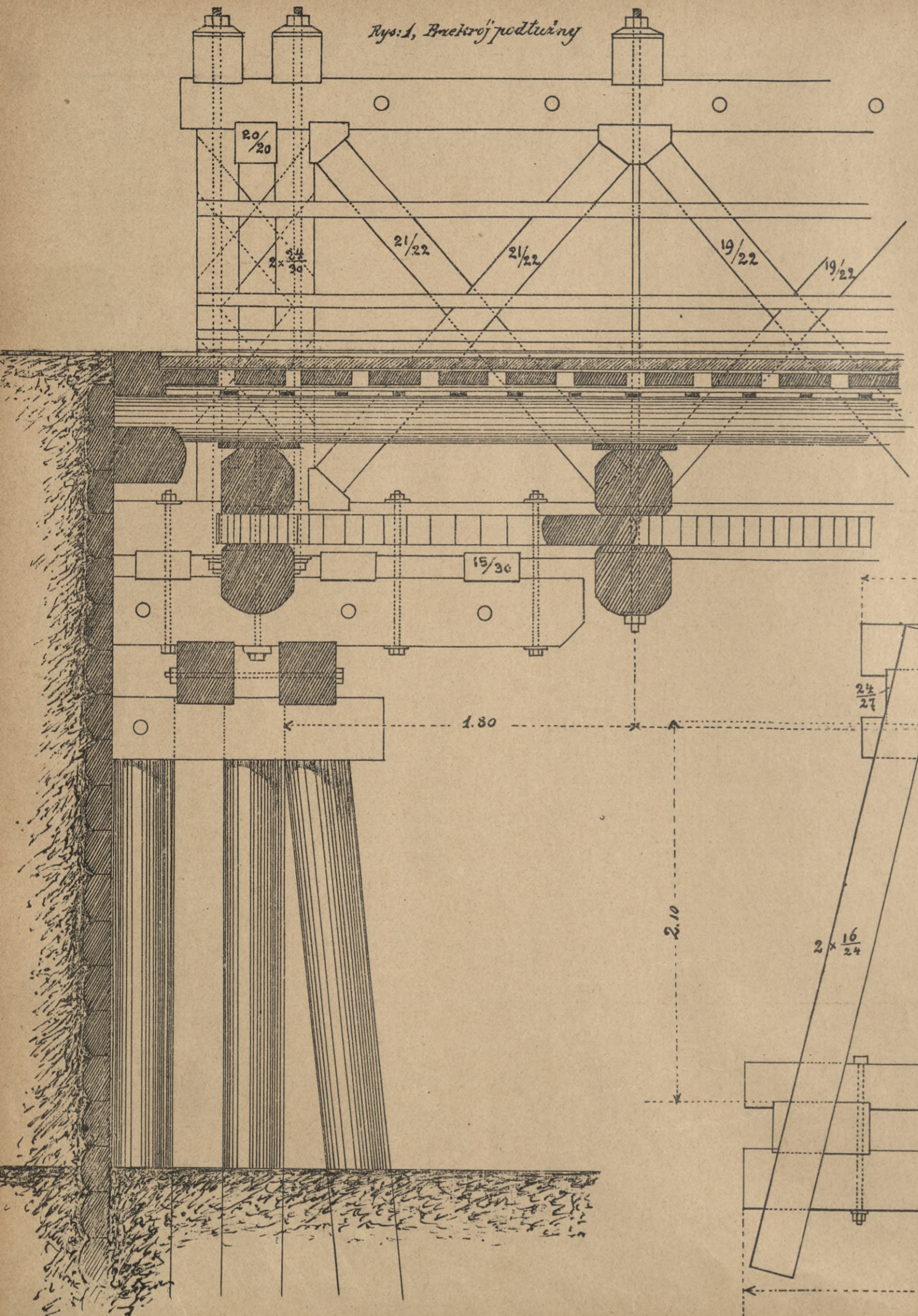

Rys. 3, Przekroj poprzeczny

Skala: 1:25,

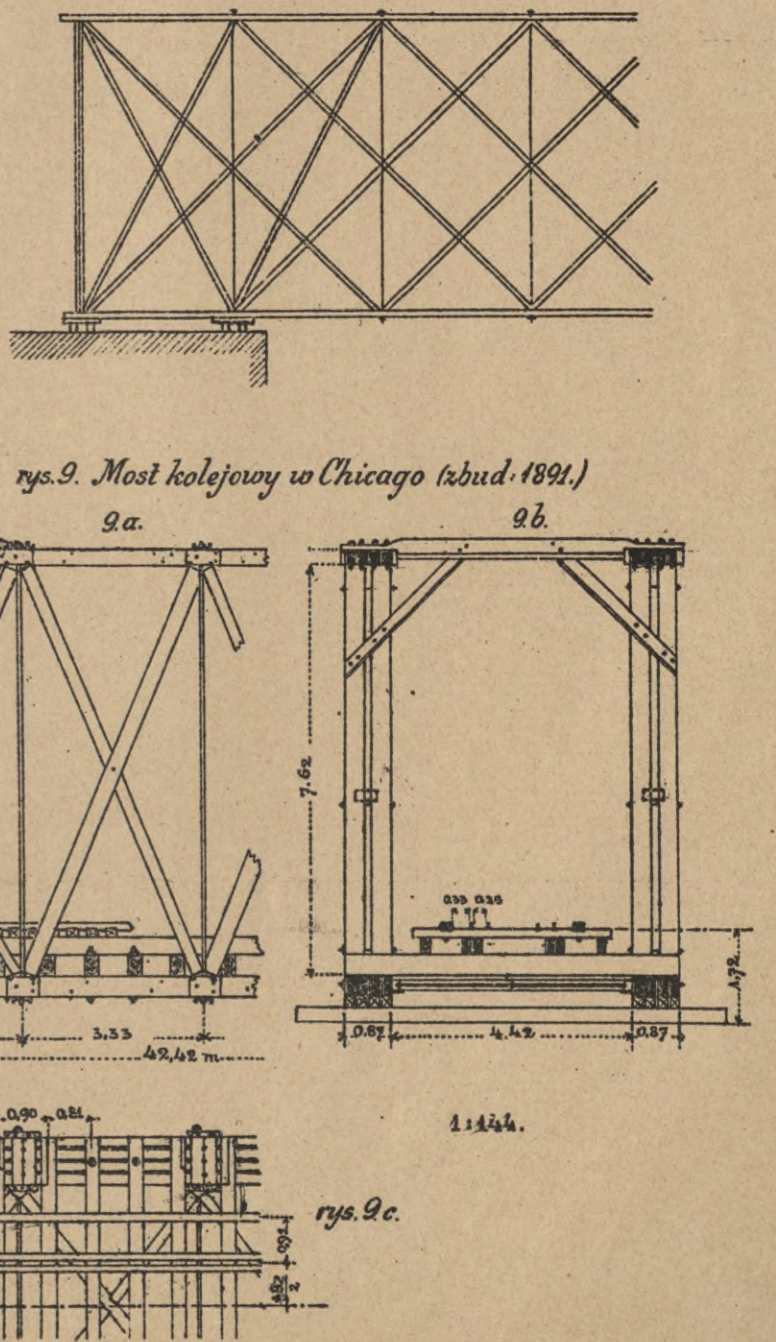
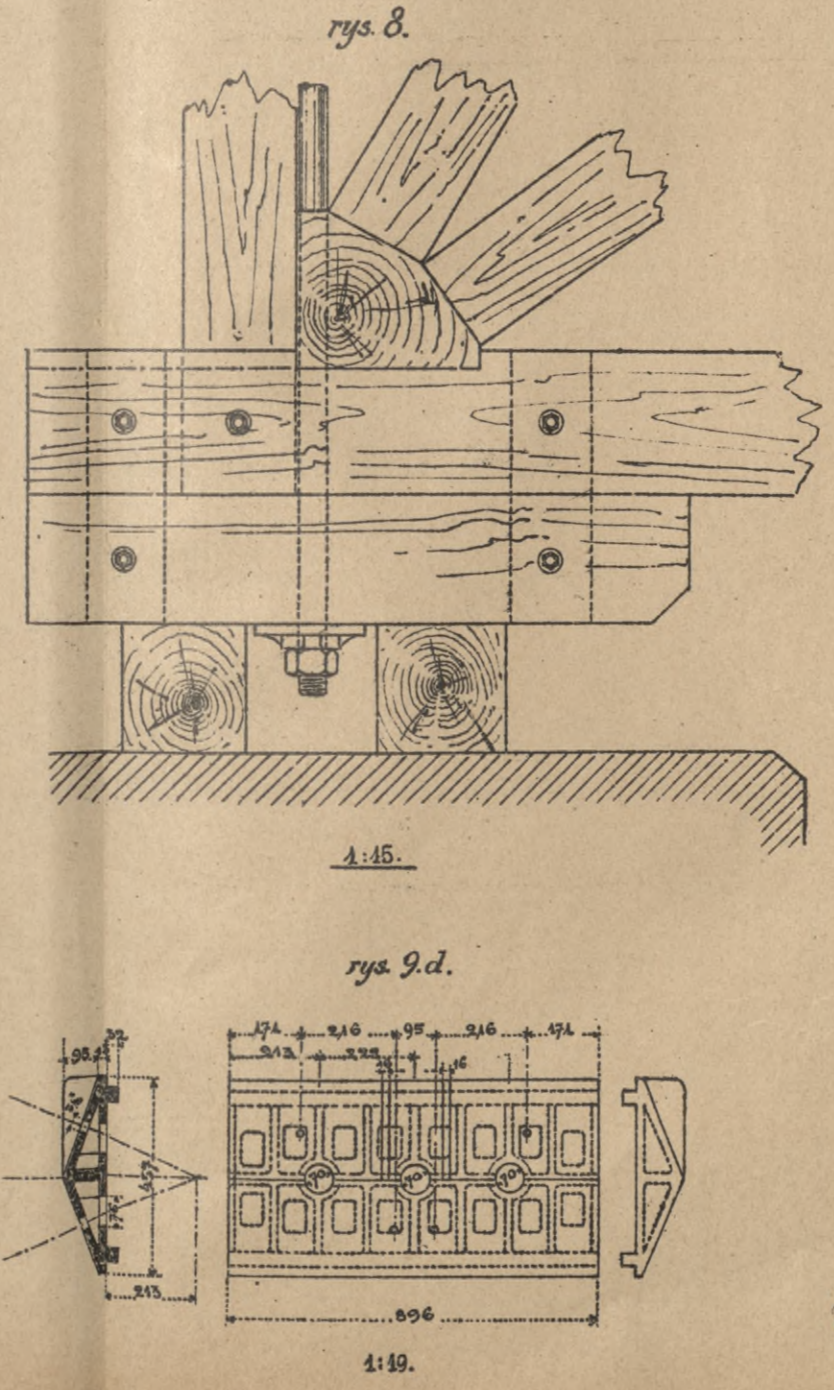
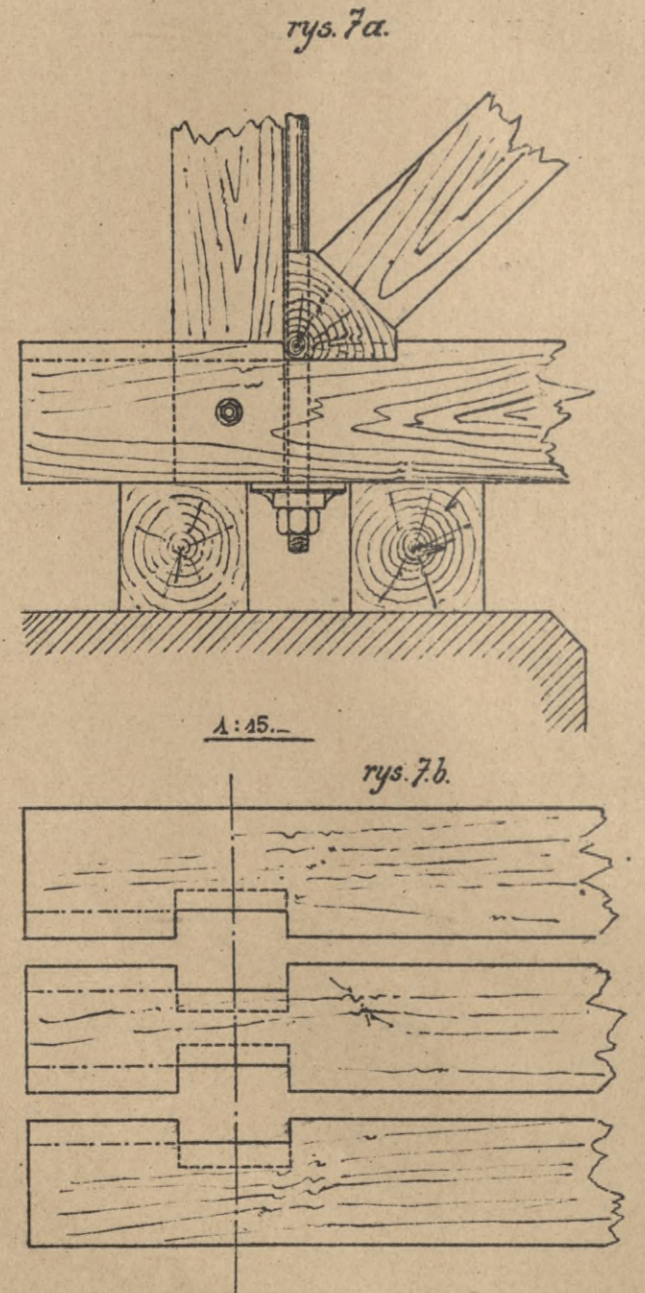
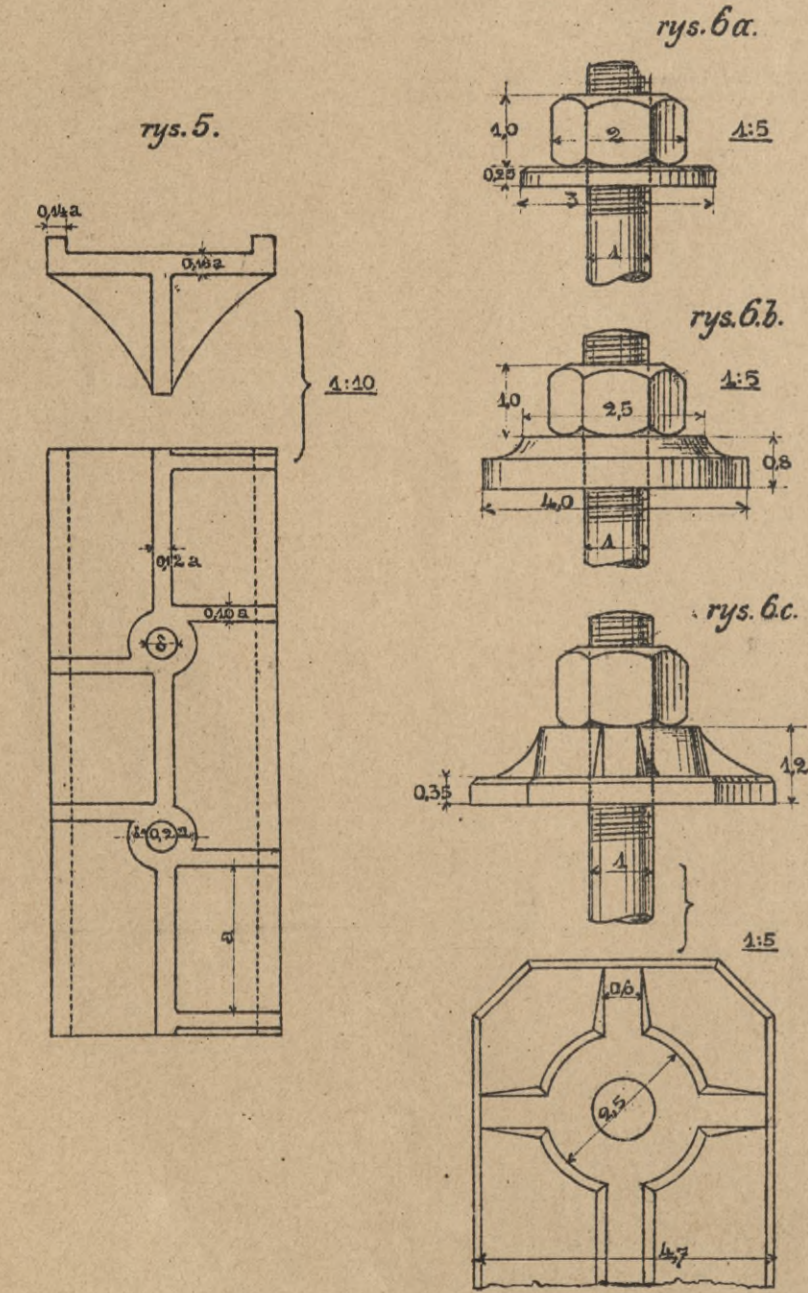
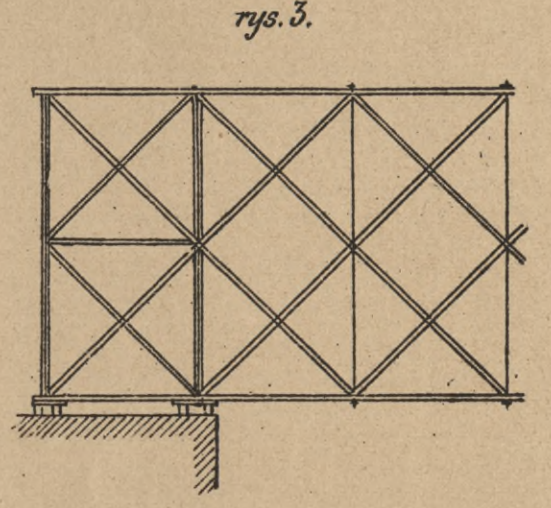
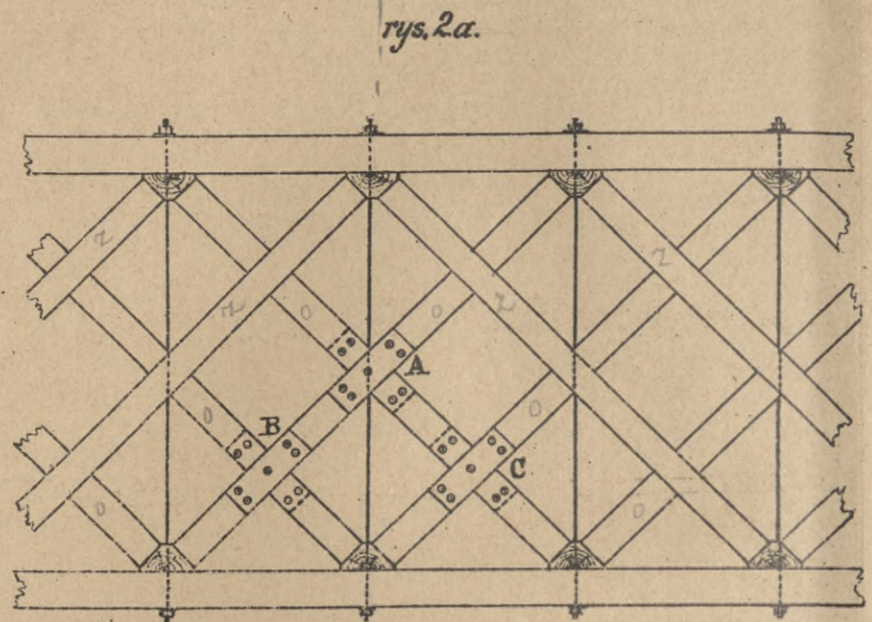
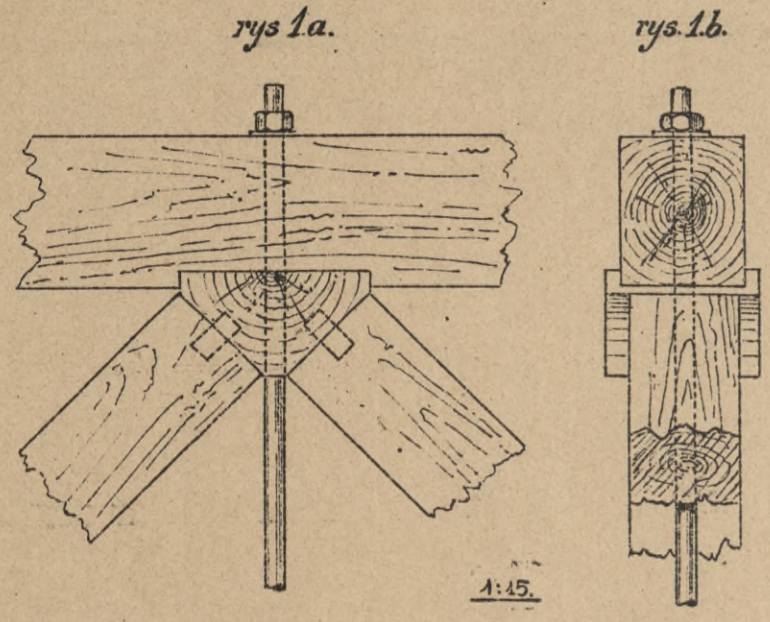

Rys. 1. Widok przyciółka i części przęsta.

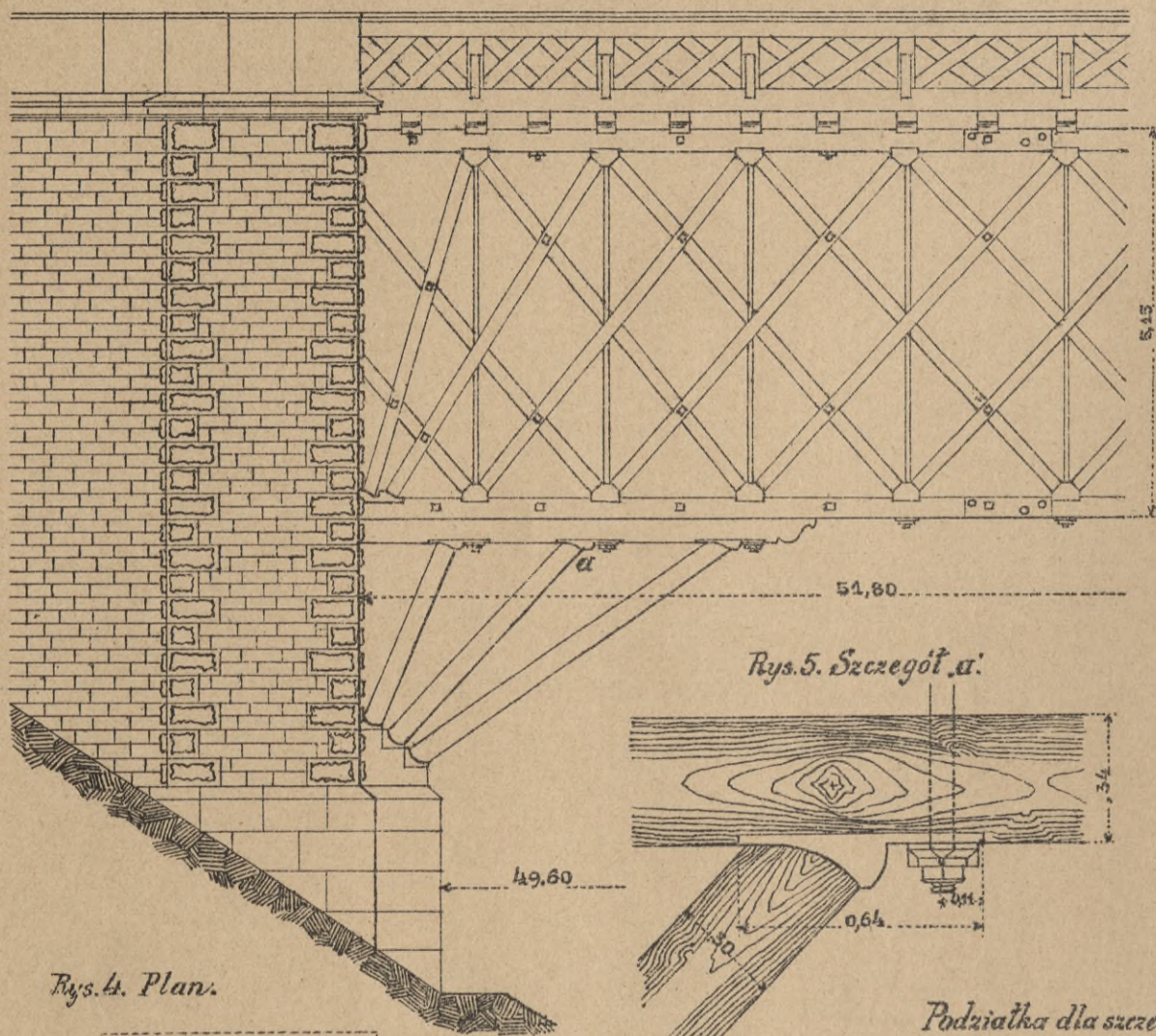

Rys. 4. Plan.

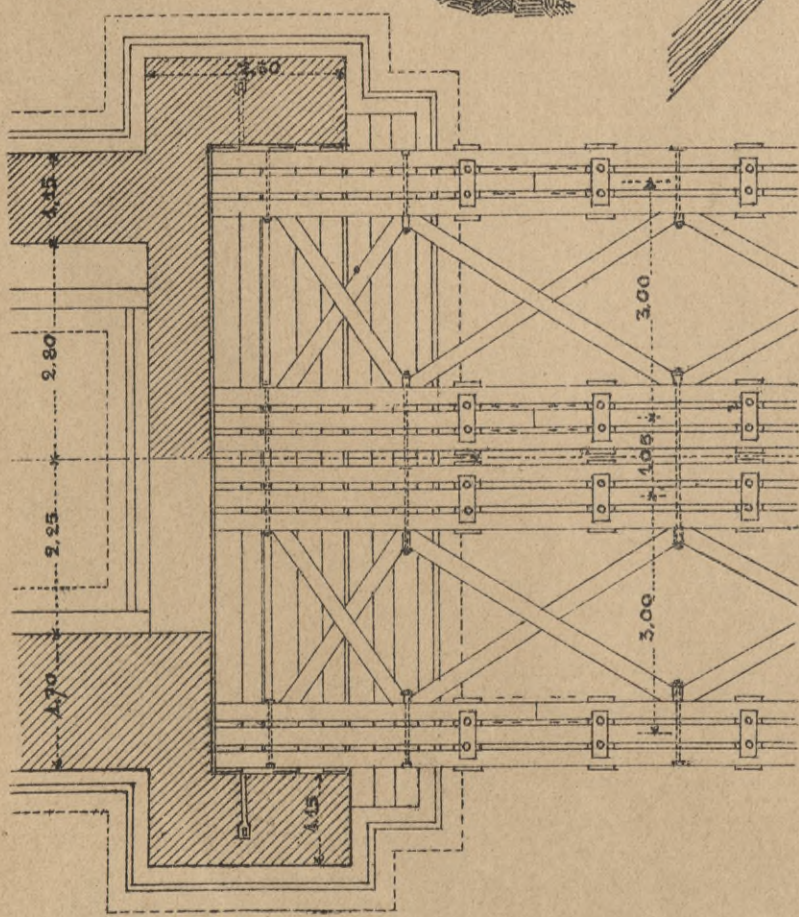

Rys. 5. Szczegół a.

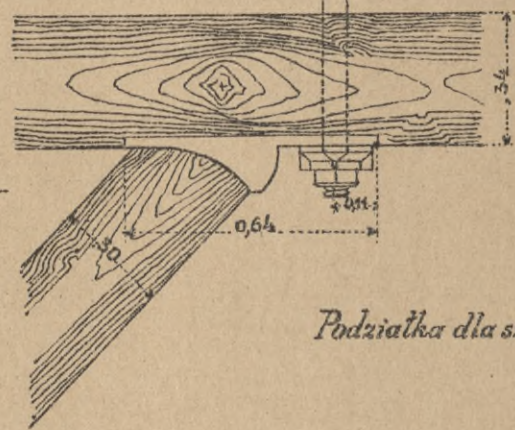

Podziałka dla szczegółów 1:20.

Rys. 6. Szczegół b.

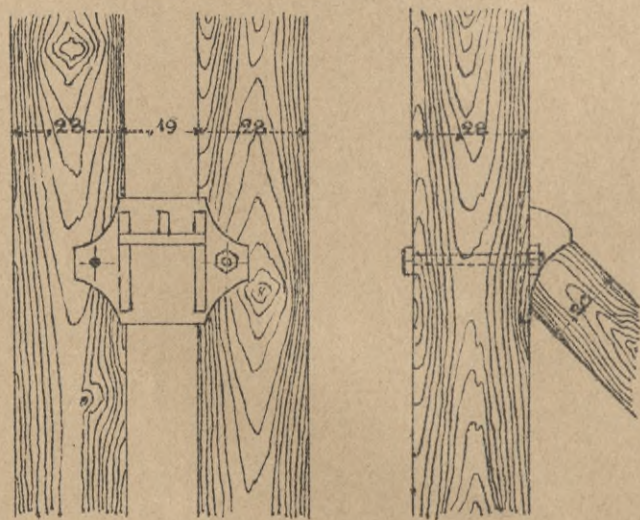

Rys. 2. Przekrój A-B.

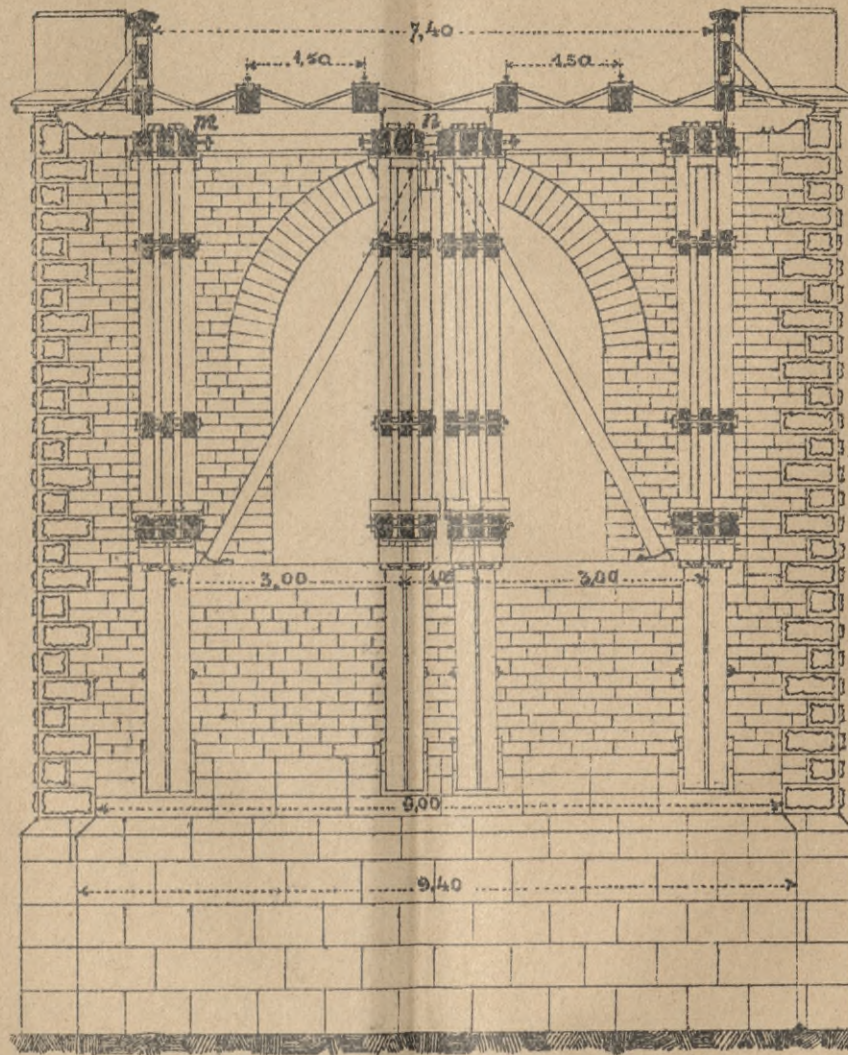

Rys. 7. Styki pasów.

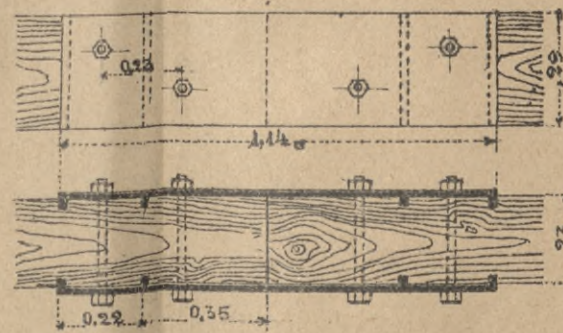

Rys. 8. Szczegół m.

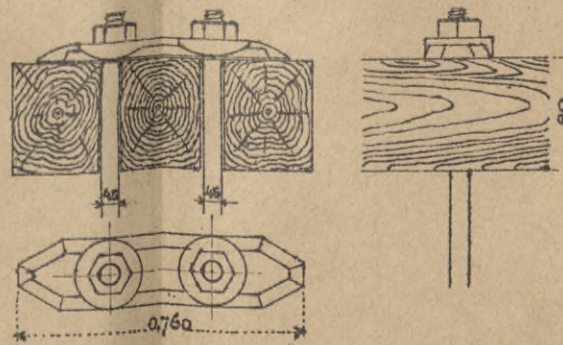

Rys. 3. Przekrój podłużny.

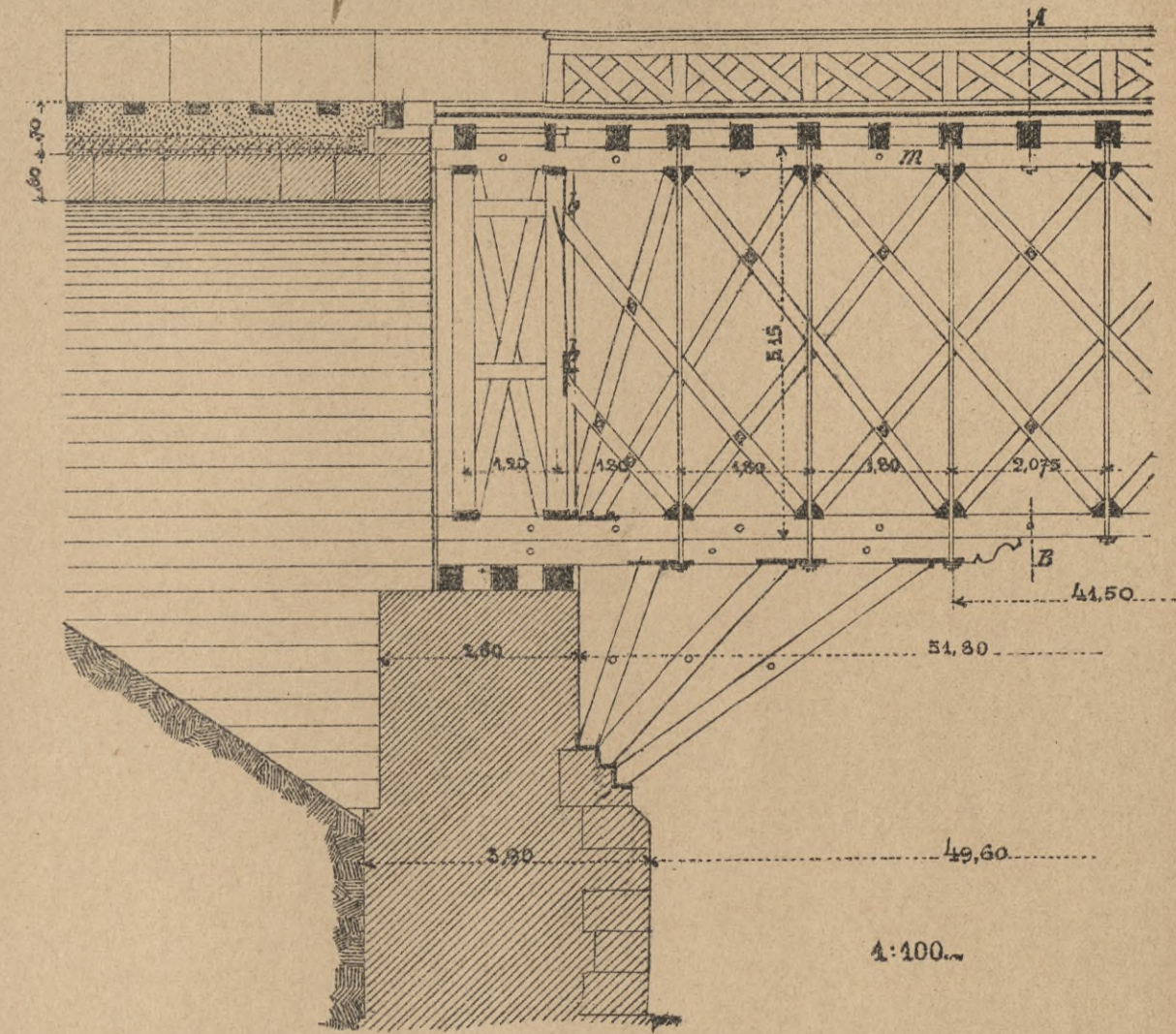

Rys. 9. Szczegół n (tężniki pionowe).

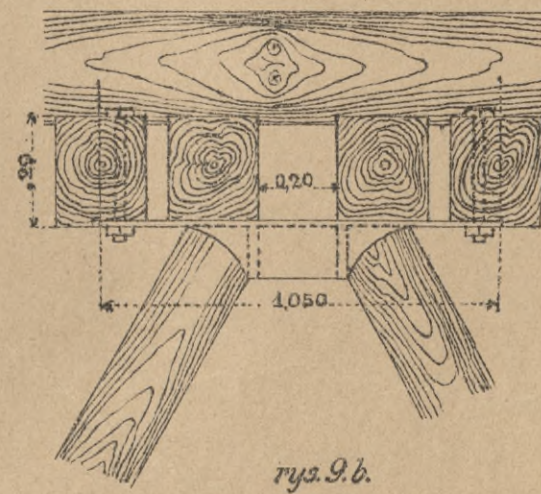

rys. 9. b.

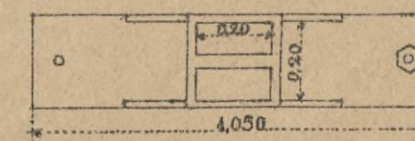

1:20.

Rys. 10. Węzeł tężników poziomych.

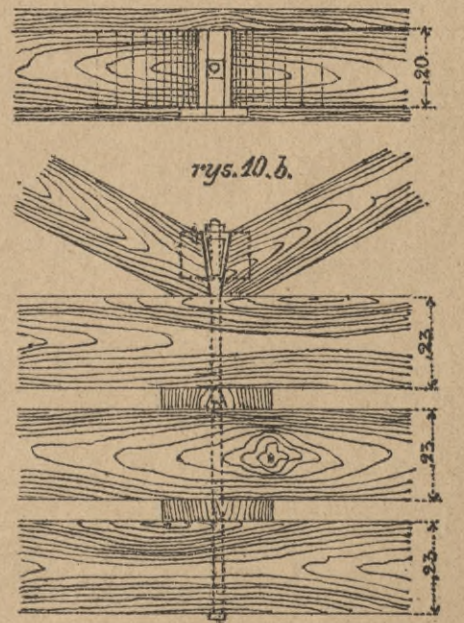

rys. 10. b.

Rys. 1. Most na Łabie pod Wittenbergiem

Rys. 1a. Widok

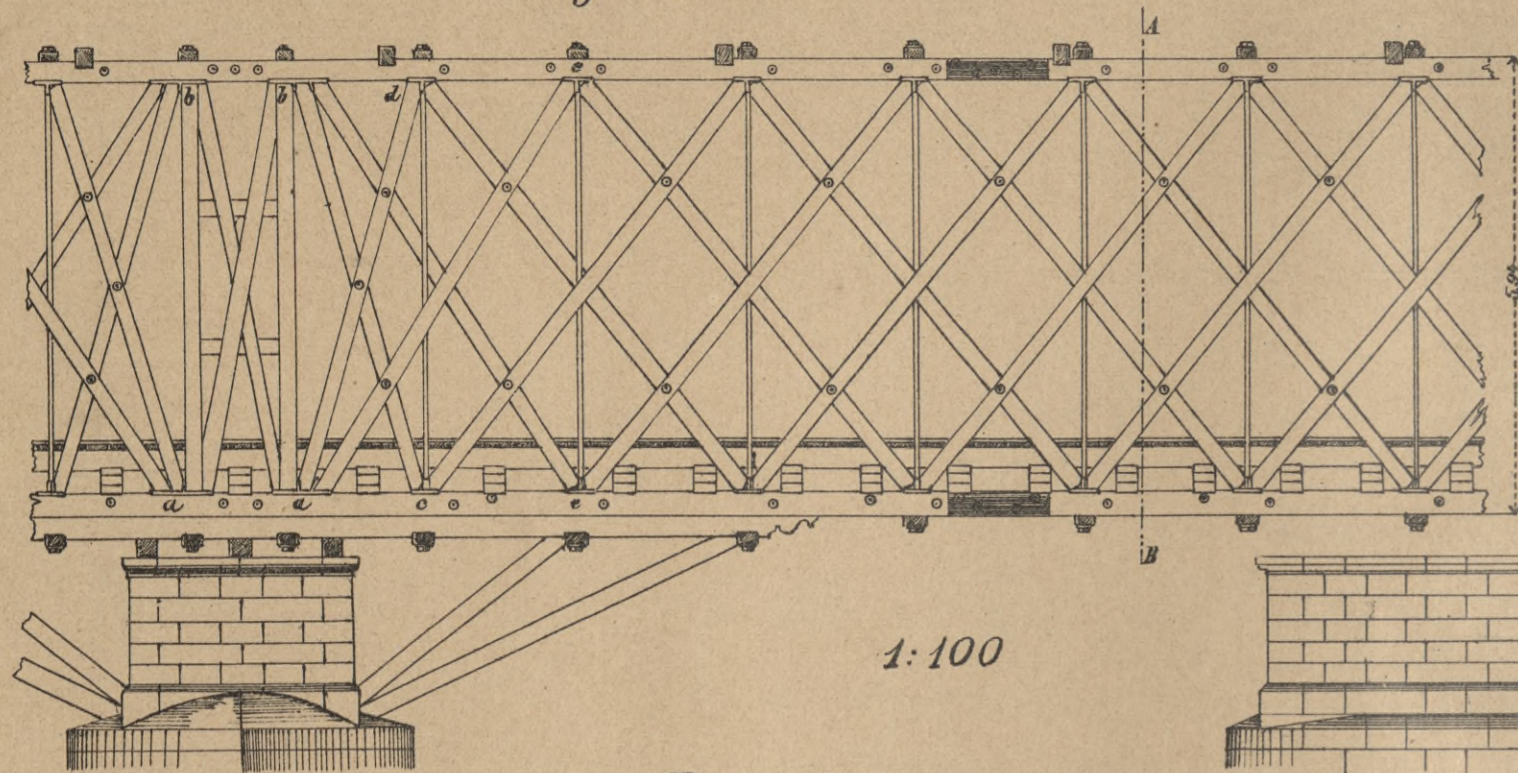

Rys. 1b. Przekrój A.B.

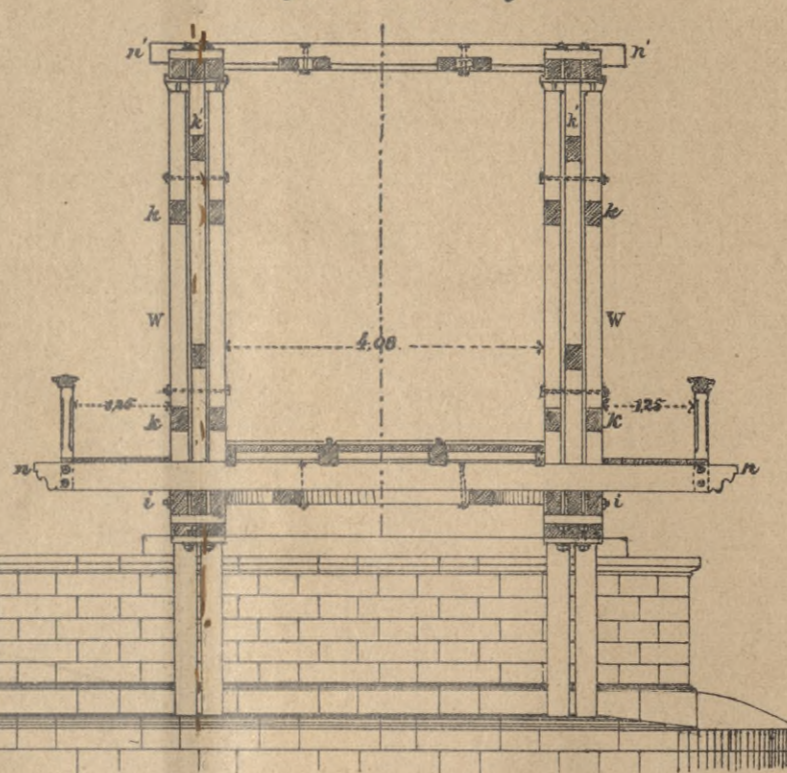

Rys. 1c. Przekrój podłużny.

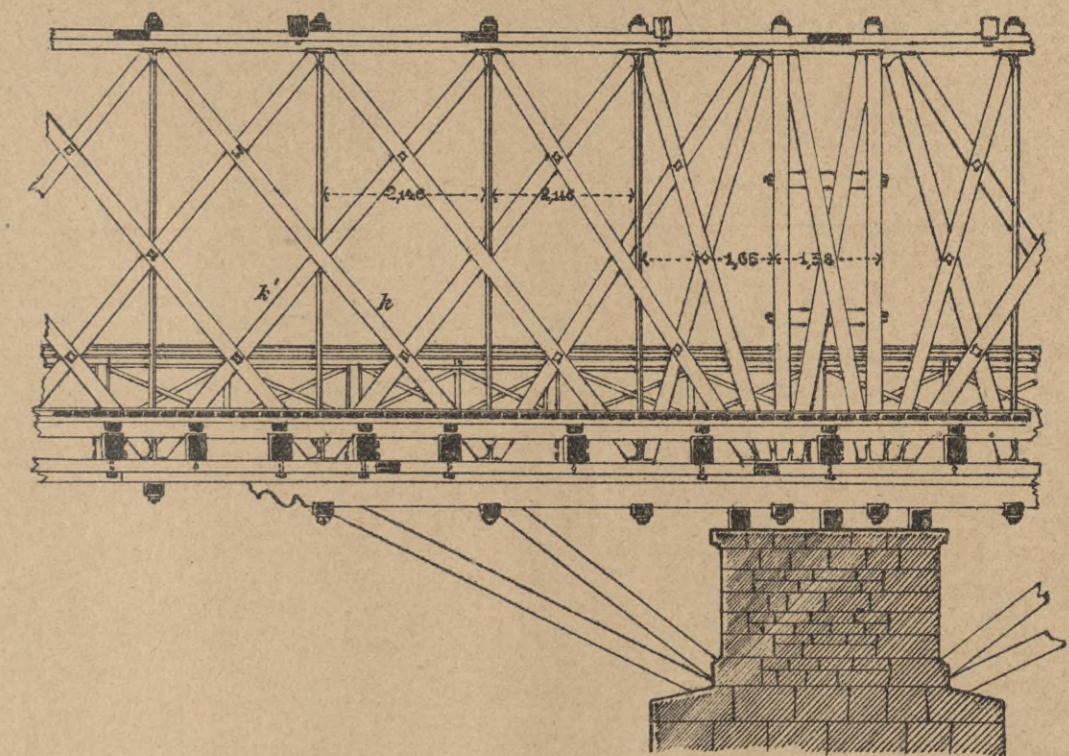

rys. 1d. Przekrój poziomy

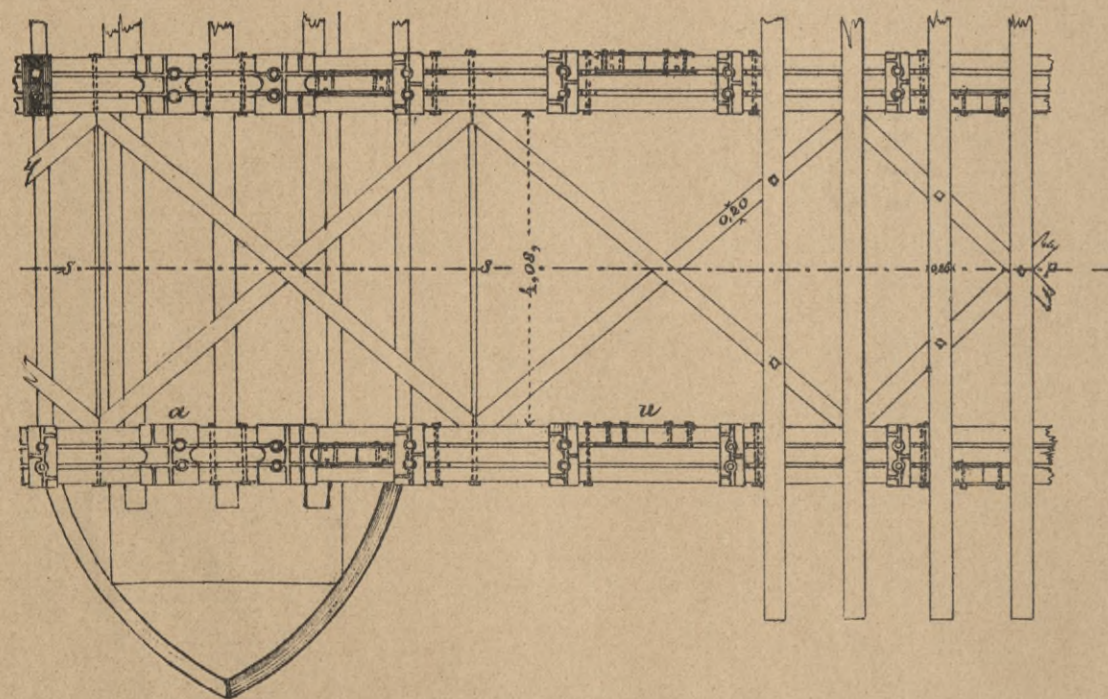

Rys. 3. Most drogowy amerykański układu Murphy Whipplego.

rys. 3a. Przekrój

rys. 3b. Widok

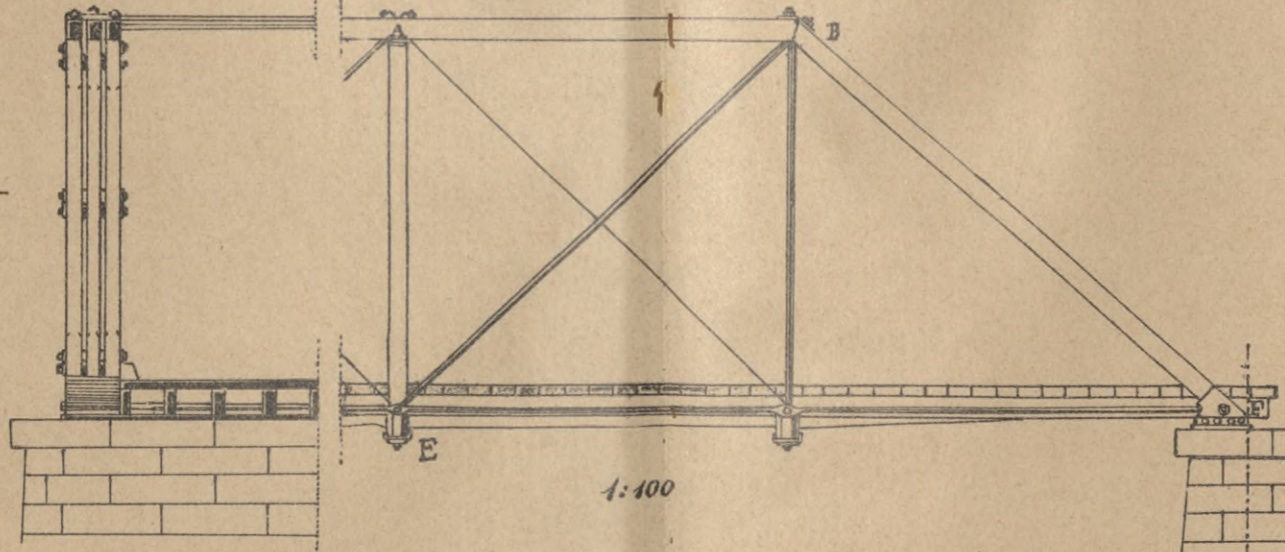

rys. 3c. Szczyt A

rys. 3d. Szczyt B

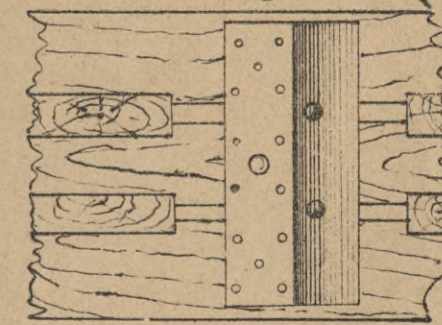
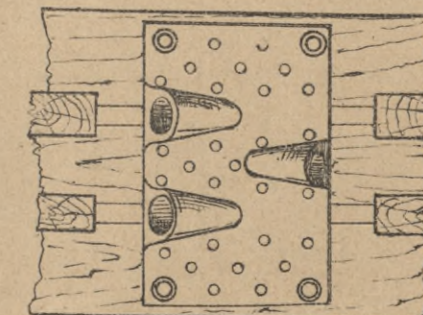
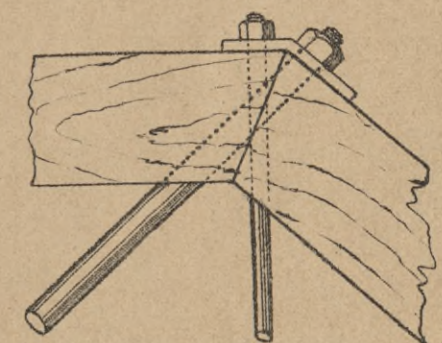
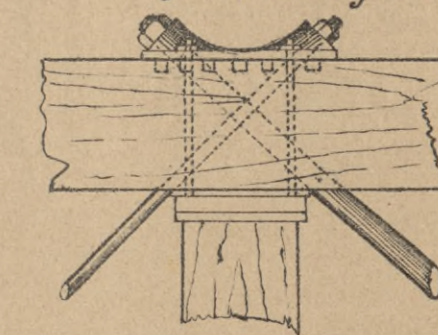

rys. 3e. Szczyt E

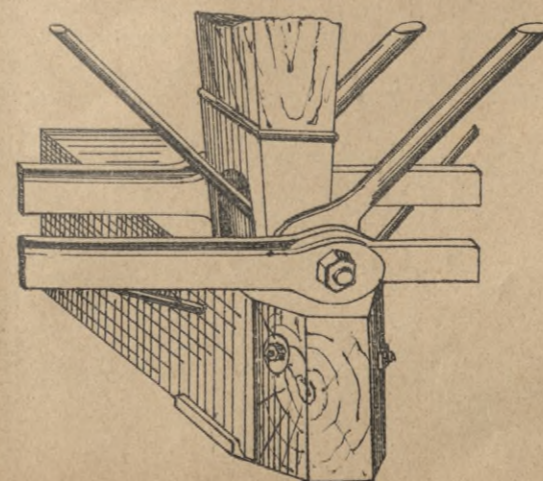

rys. 2. Łubki drewniane przy amerykańskich mostach Howe'a,

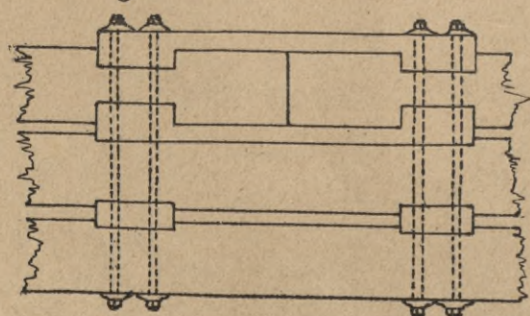

rys. 3c.

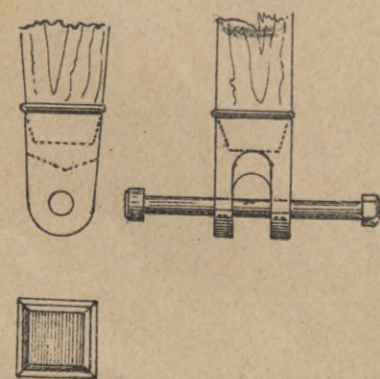

rys. 4. Most na Wiarce pod Przemysłem. Przekrój



ZETKNIĘCIA PASU.

rys. 1.

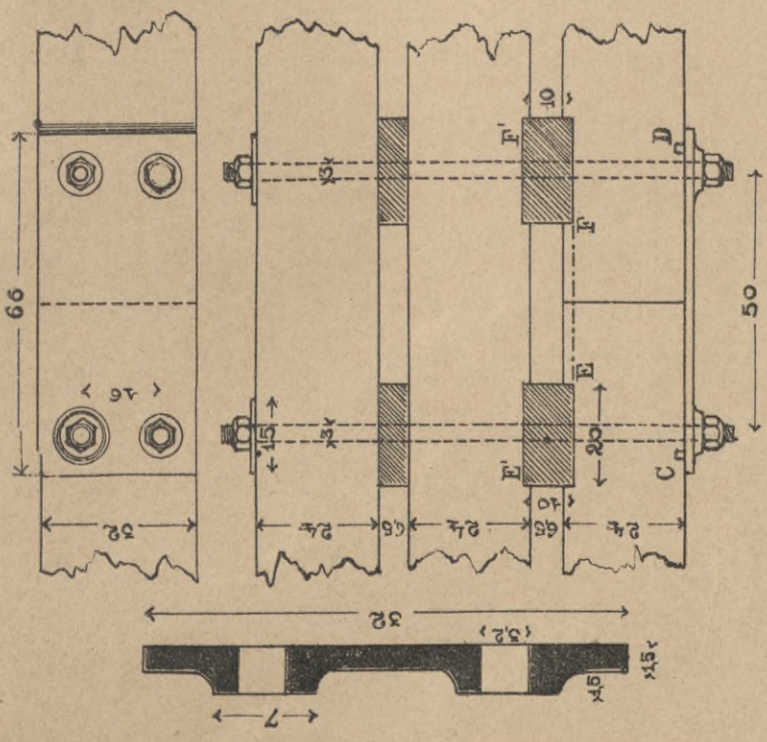

rys. 2.

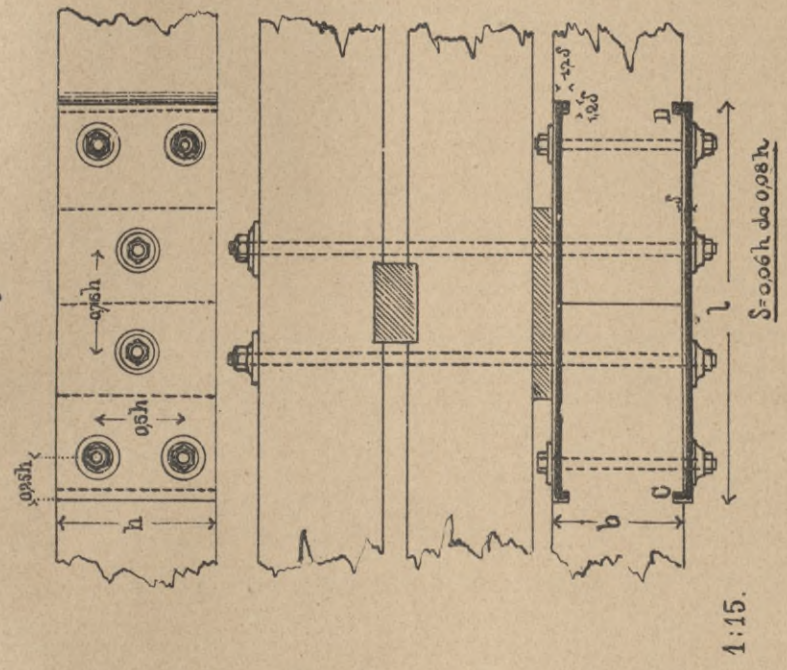

rys. 3.

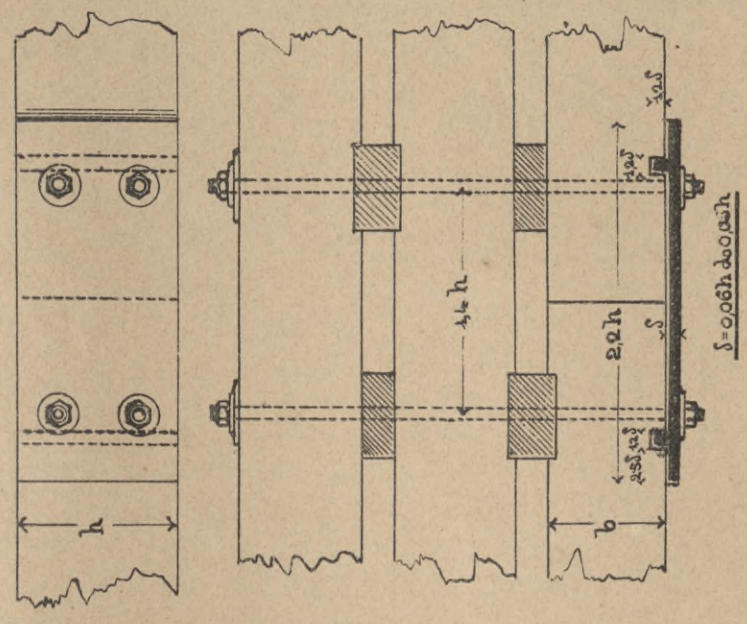

rys. 4.

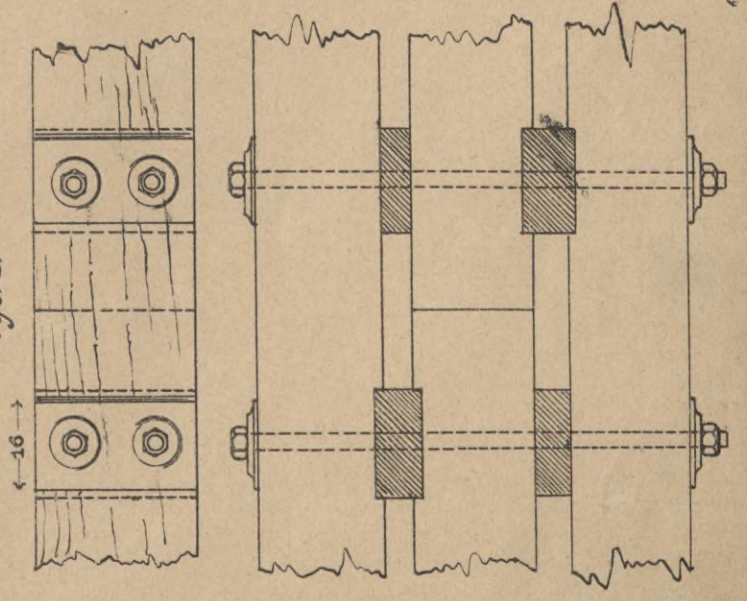

rys. 5.

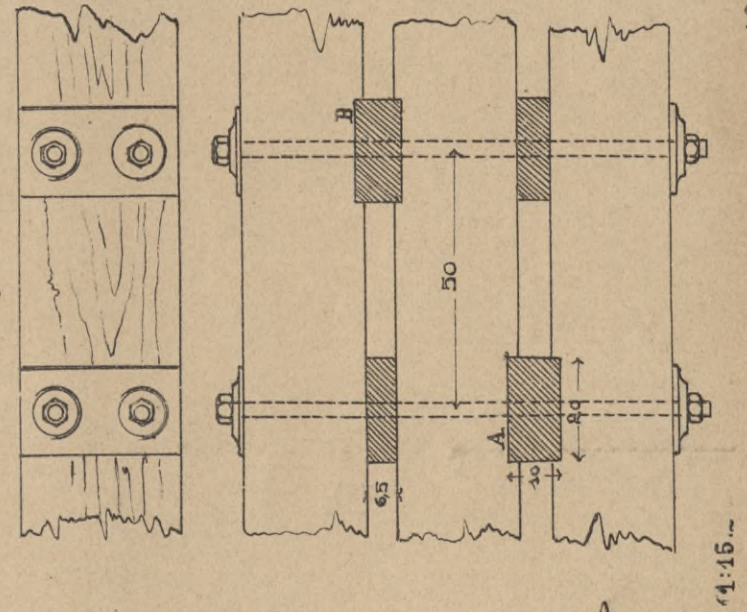

rys. 6. Poprzecznicą w węzle...

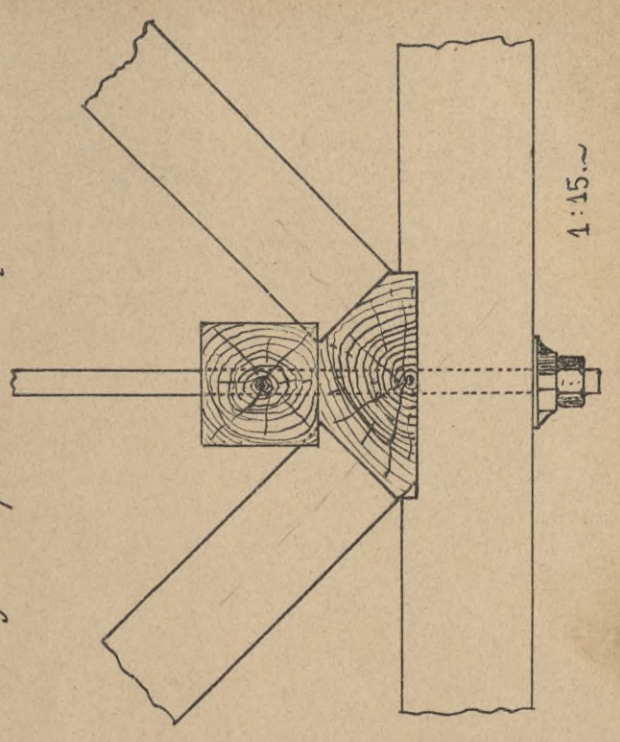

OBLICZENIE BELKI PINTOWSKIEGO

rys. 1

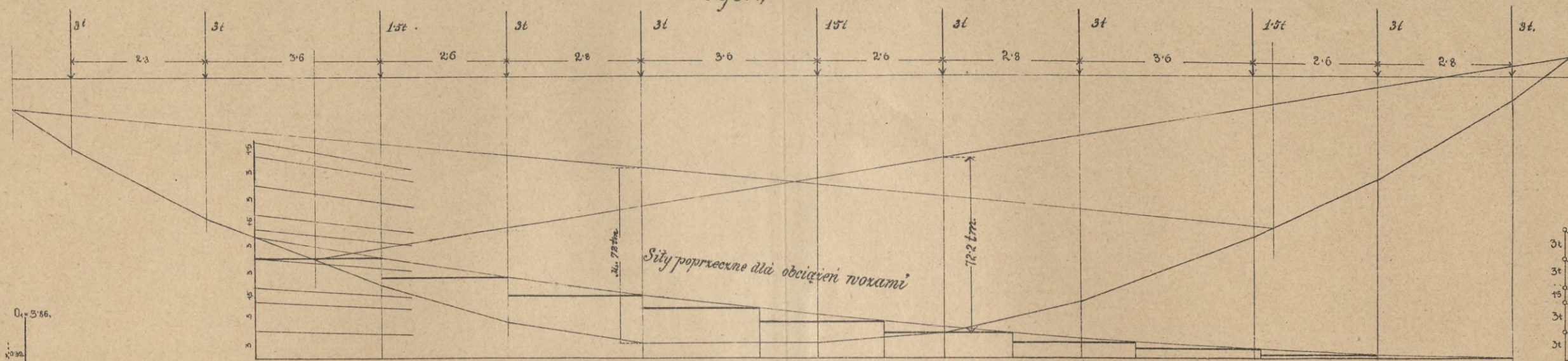

Poprzecznica.

rys. 2. Momenty.

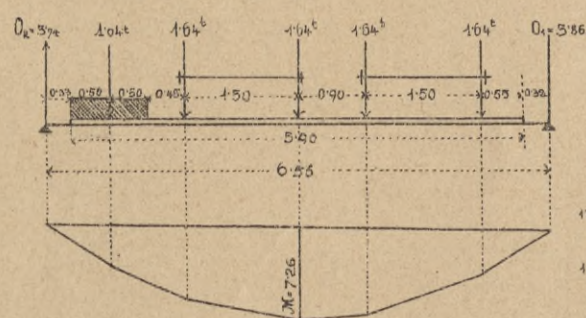

rys. 2

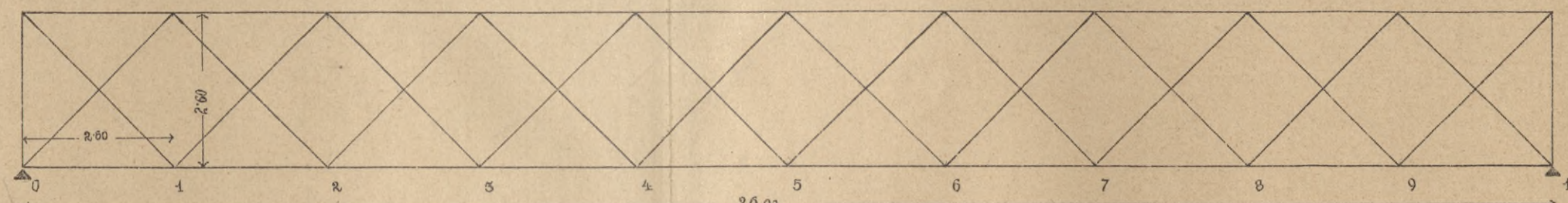

Sily poprzeczne.
(Wklad ciężarów dla a, dla b)

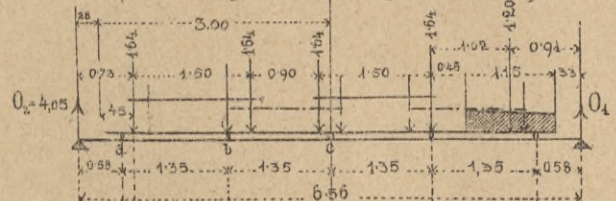

rys. 5.

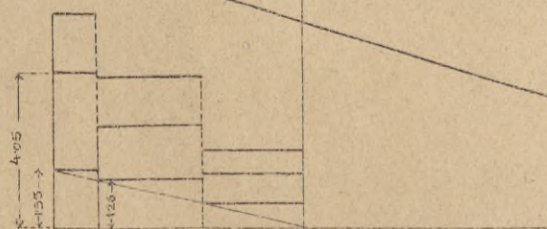

rys. 6. Rozkład klinowy.

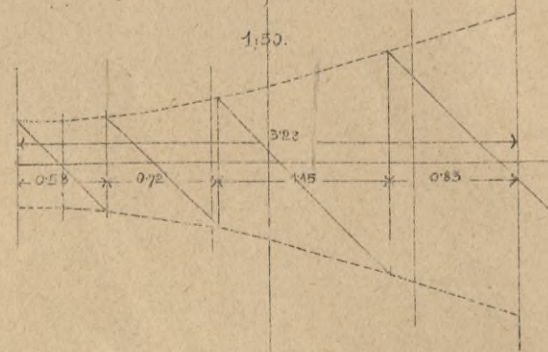

rys. 3

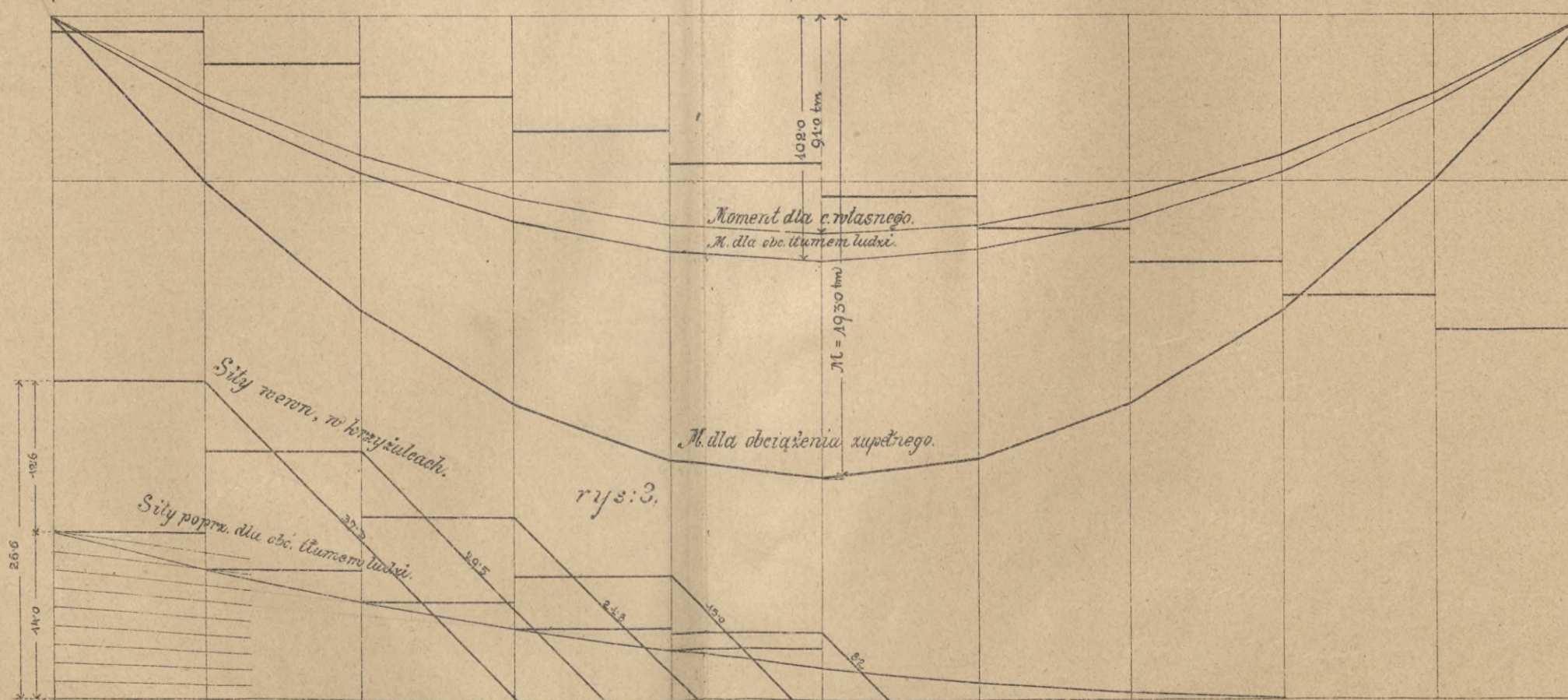

Skala:



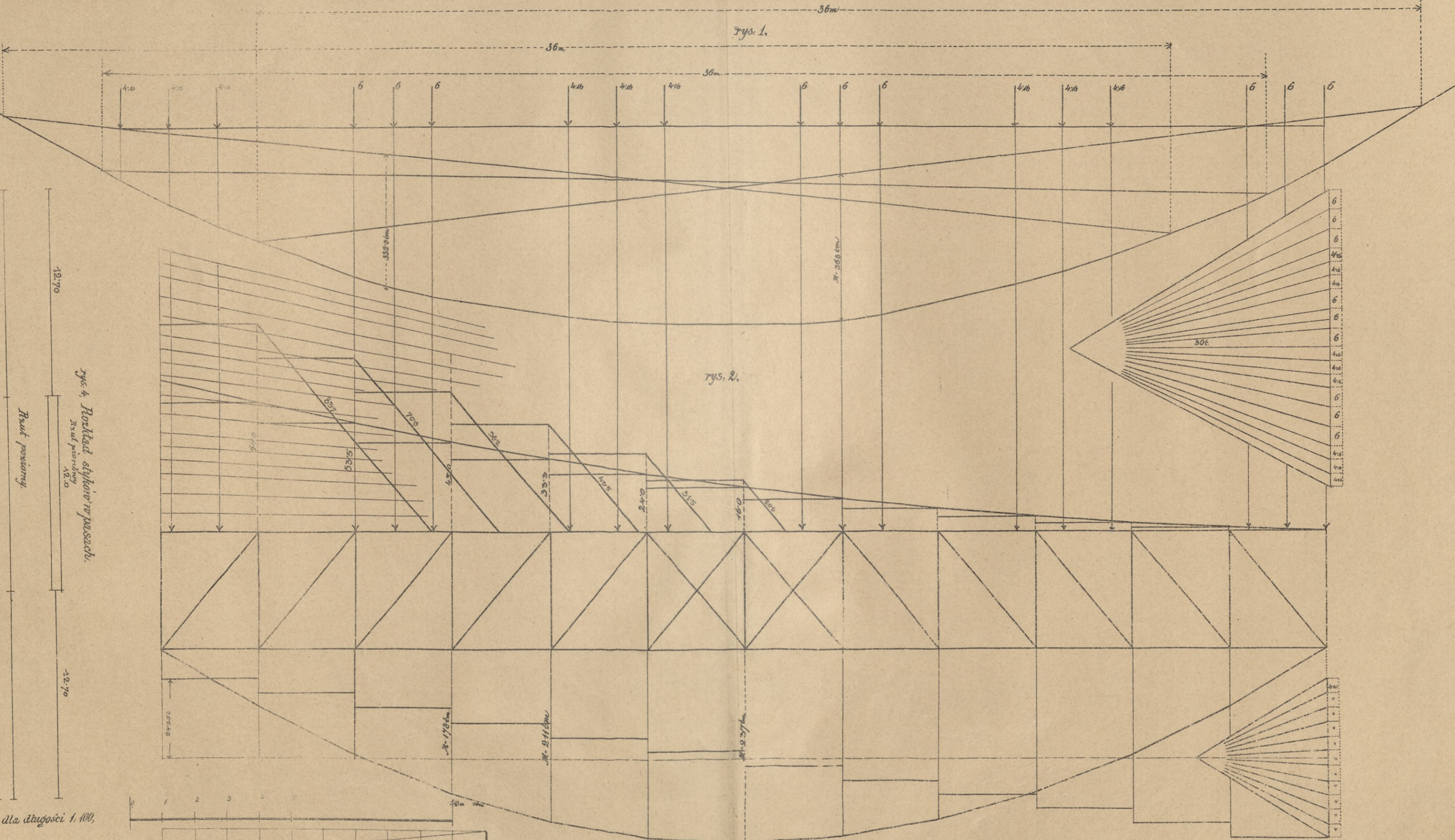

OBLICZENIE BELKI HOWEA

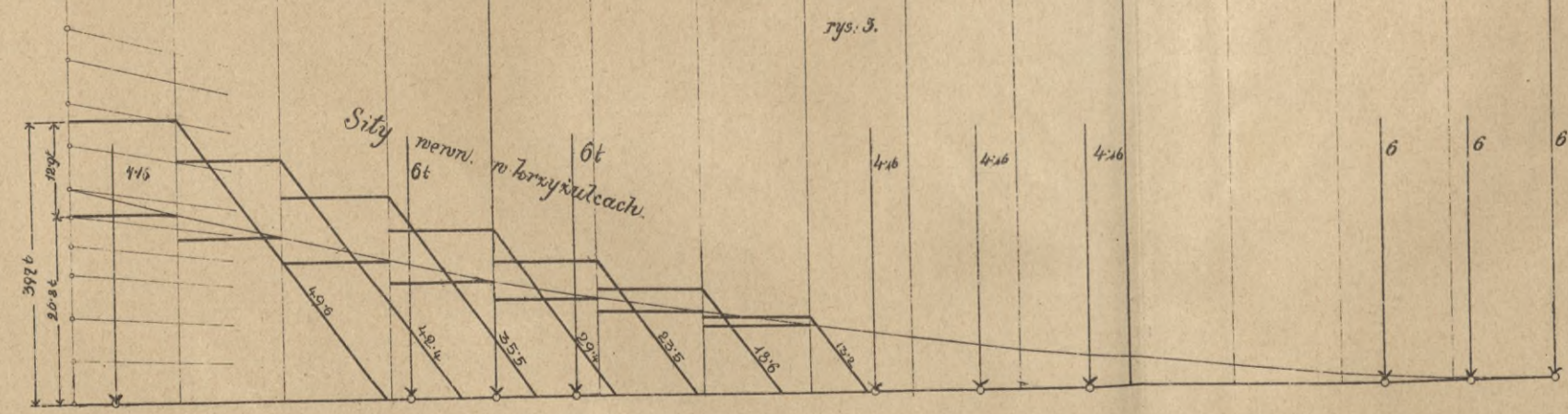
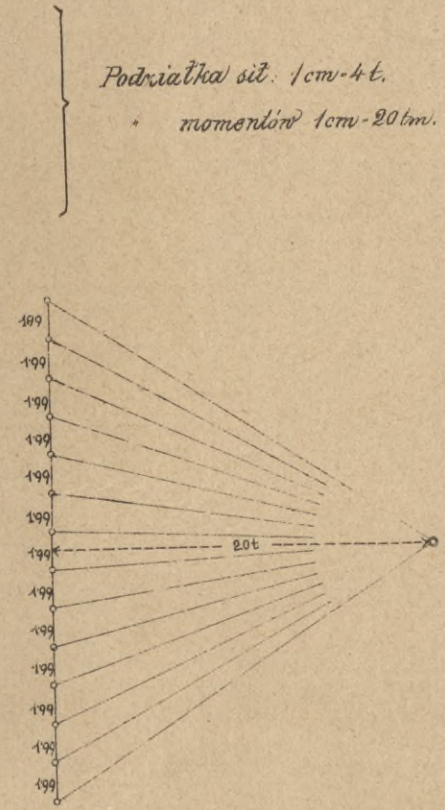
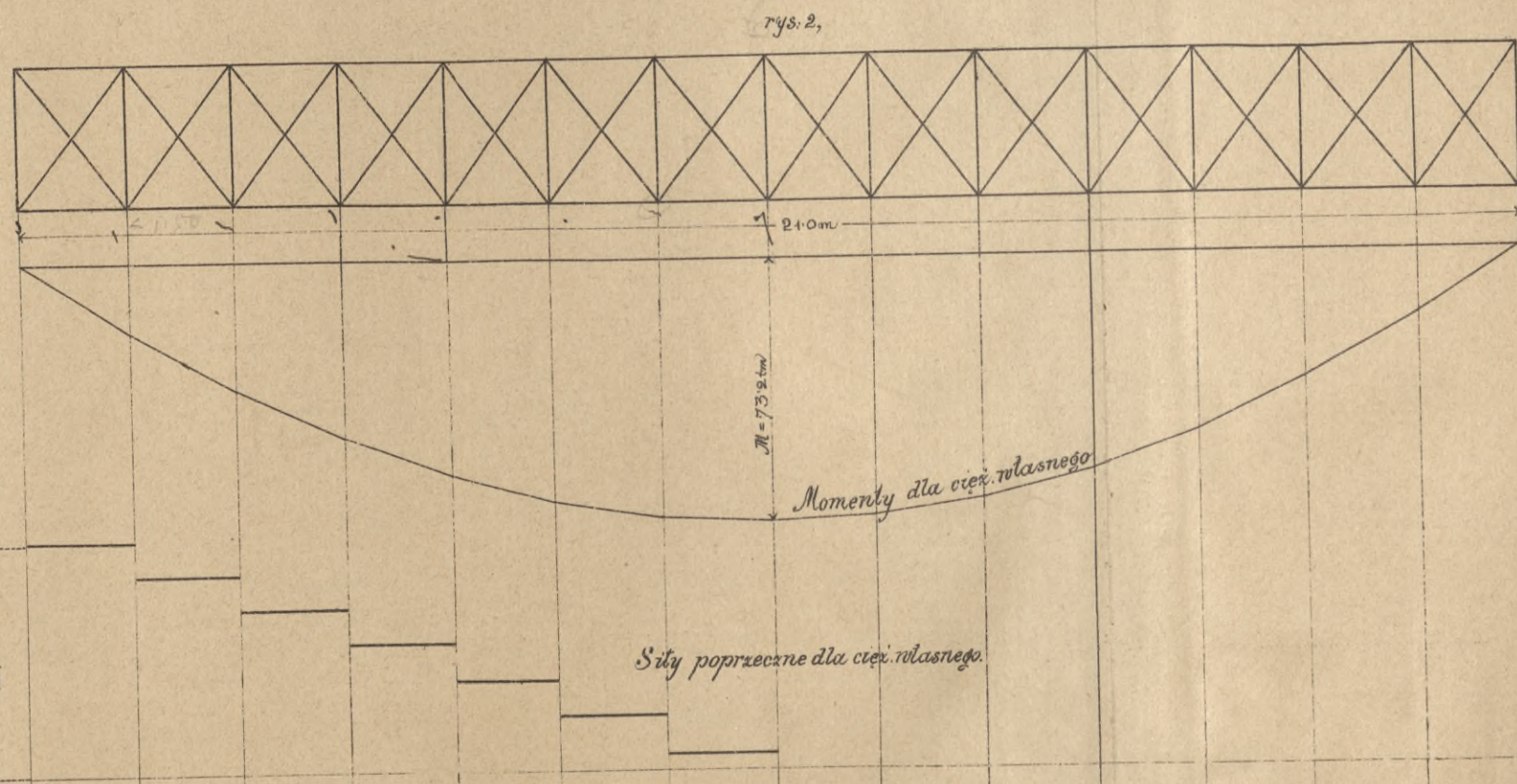
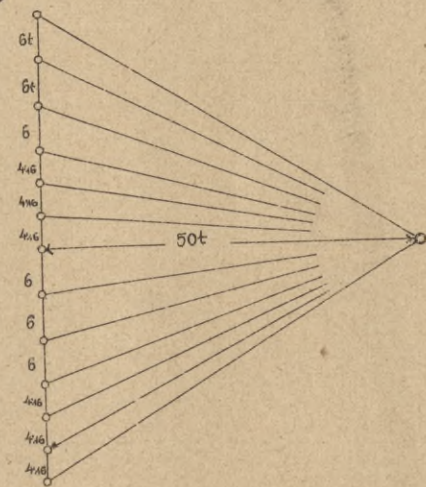
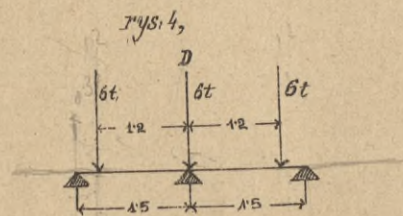
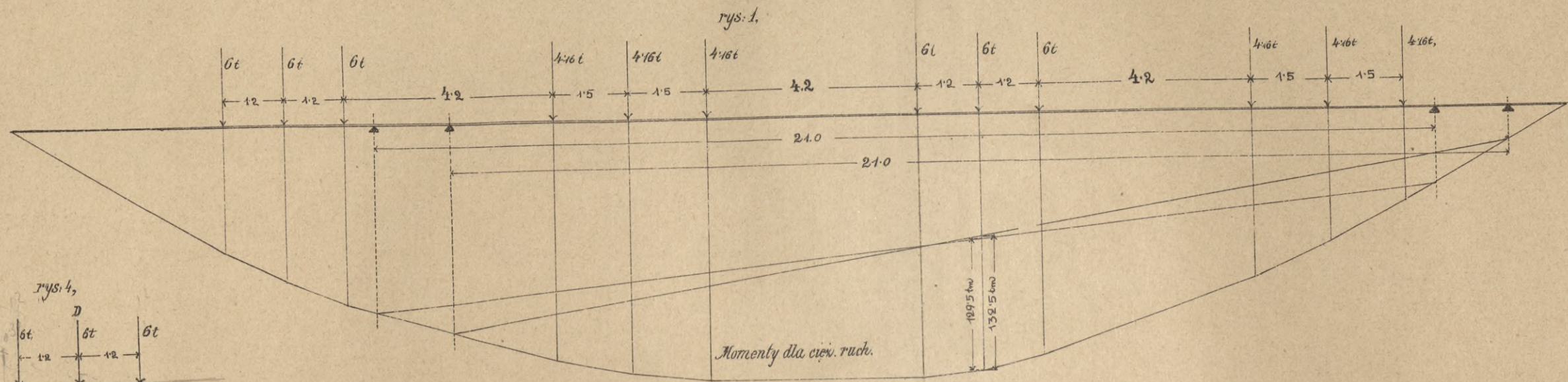

rys. 5.
Rozkład linonów
w poprzeczniicy
1:50.

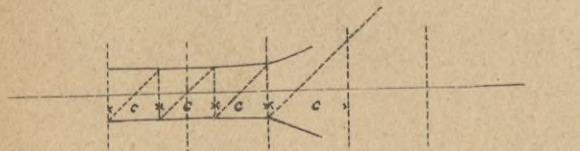

Podziałka sił: 1cm = 10t

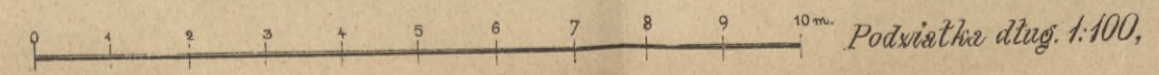

rys. 6.
Rozkład styków w pasach

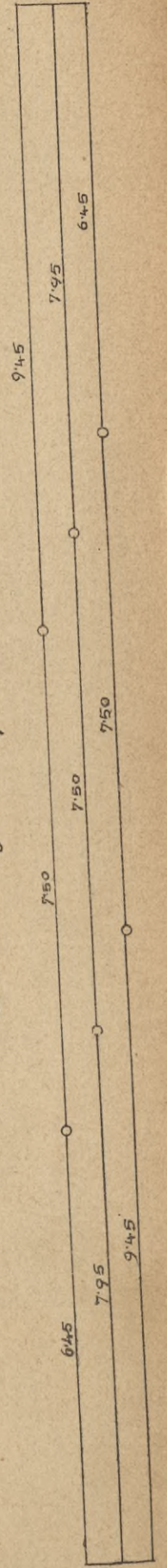

o pomoście górą, a rozpiętości 30,0 m.

Rys 1a. Widok.

Rys 1b. Przekrój podłużny.

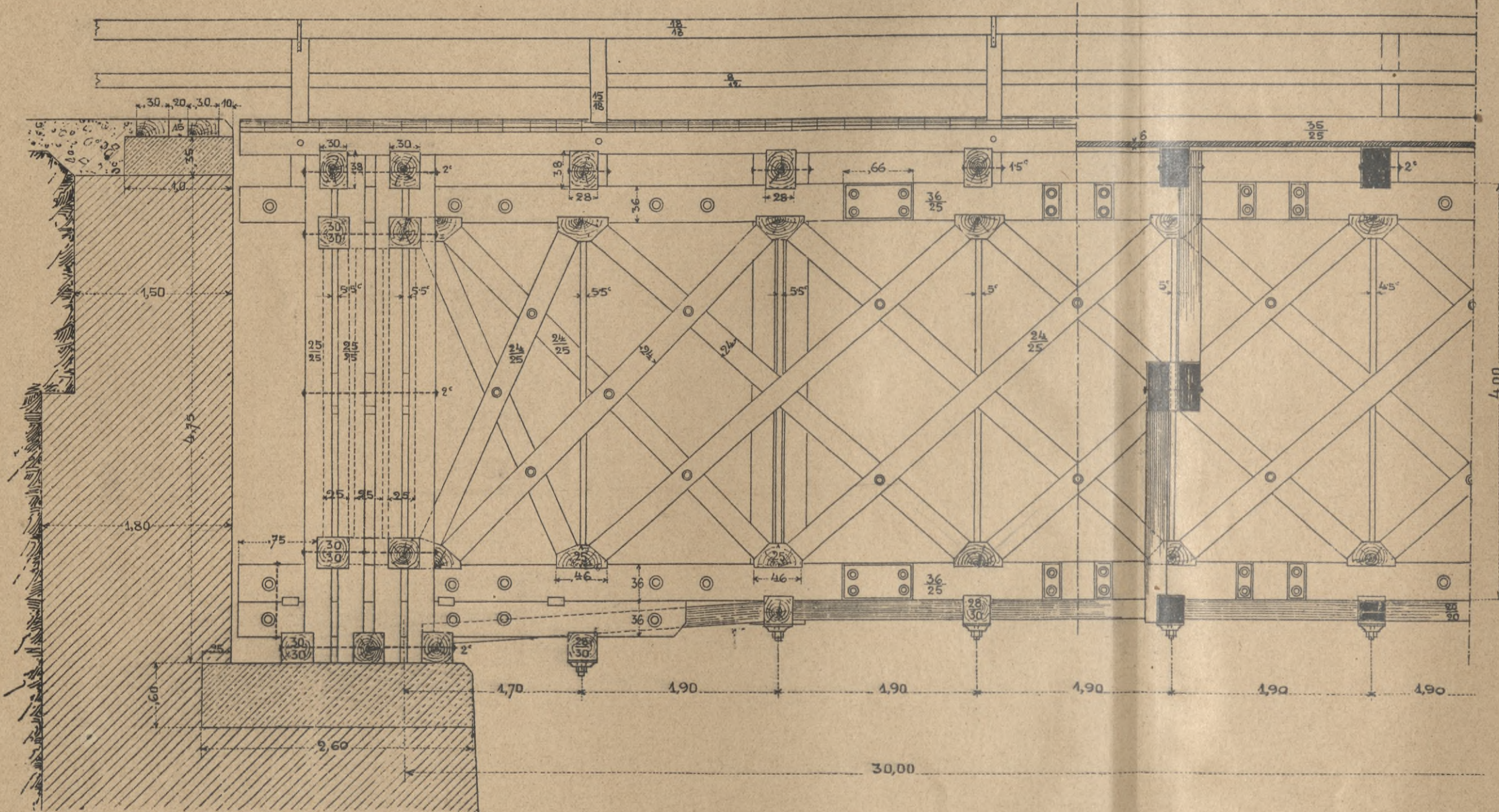

1:50~

rys.3. Przekrój
a) przy przyczółku b) środkowy.

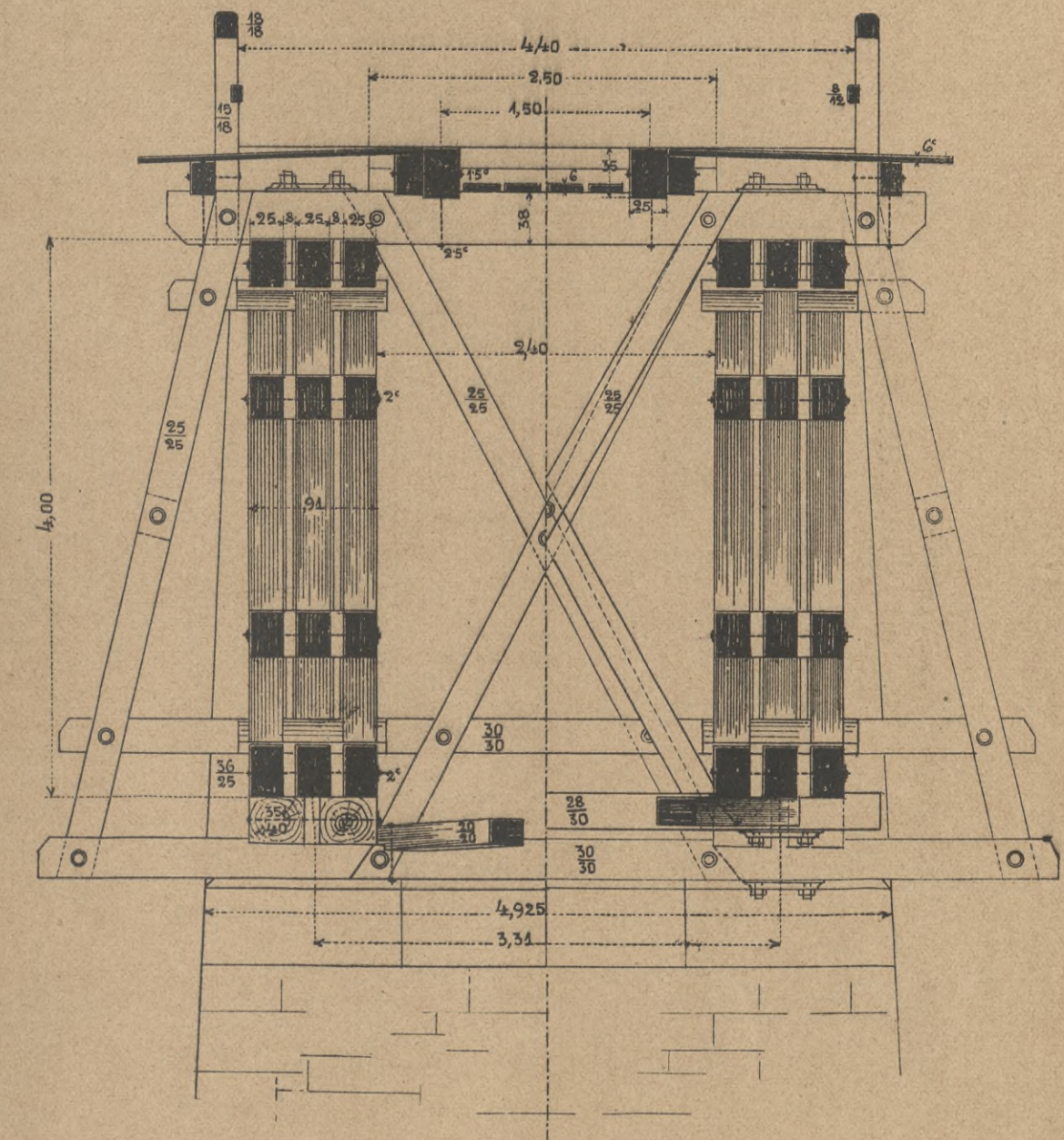

Rys 2. Przekrój poziomy.

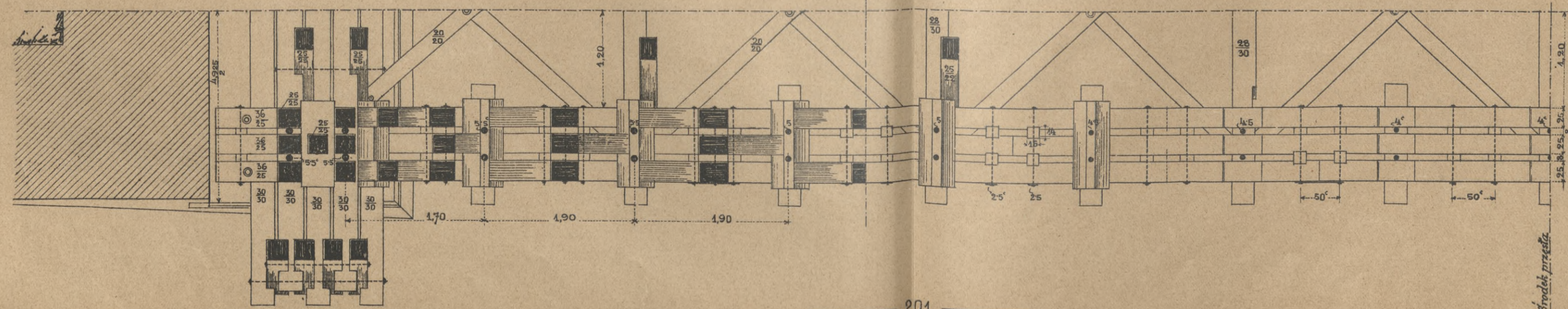

rys.4. Techniki poziome..

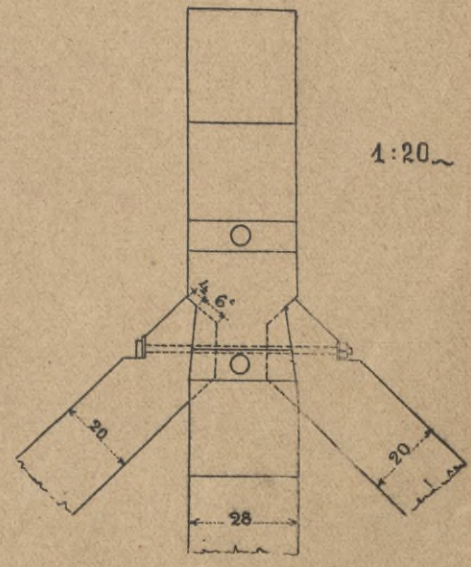

1:20~

o pomoście dołem a rozpiętości 30,0 m.

Rys.1 Widok.

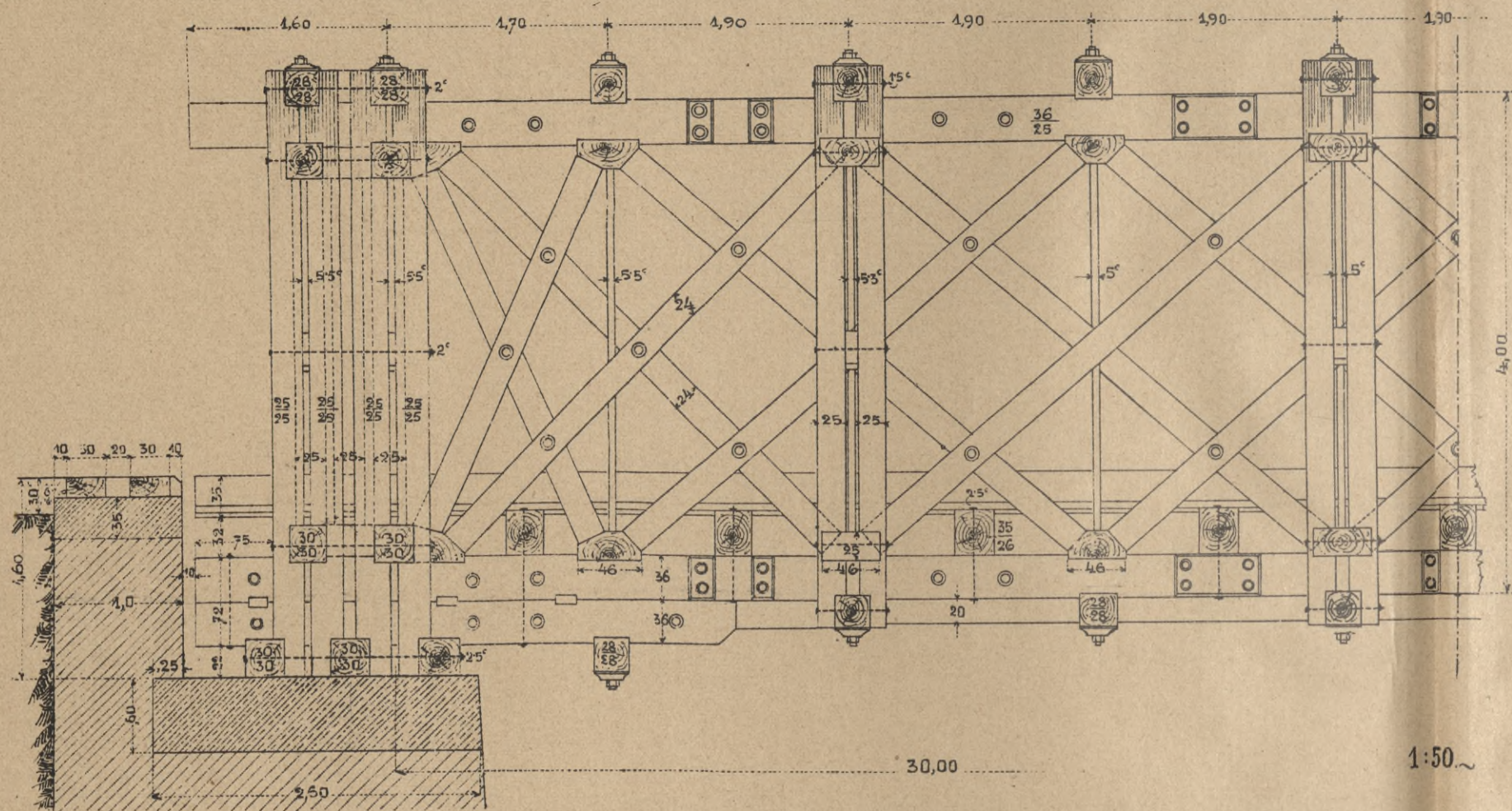

rys.3. Przekrój poziomy.

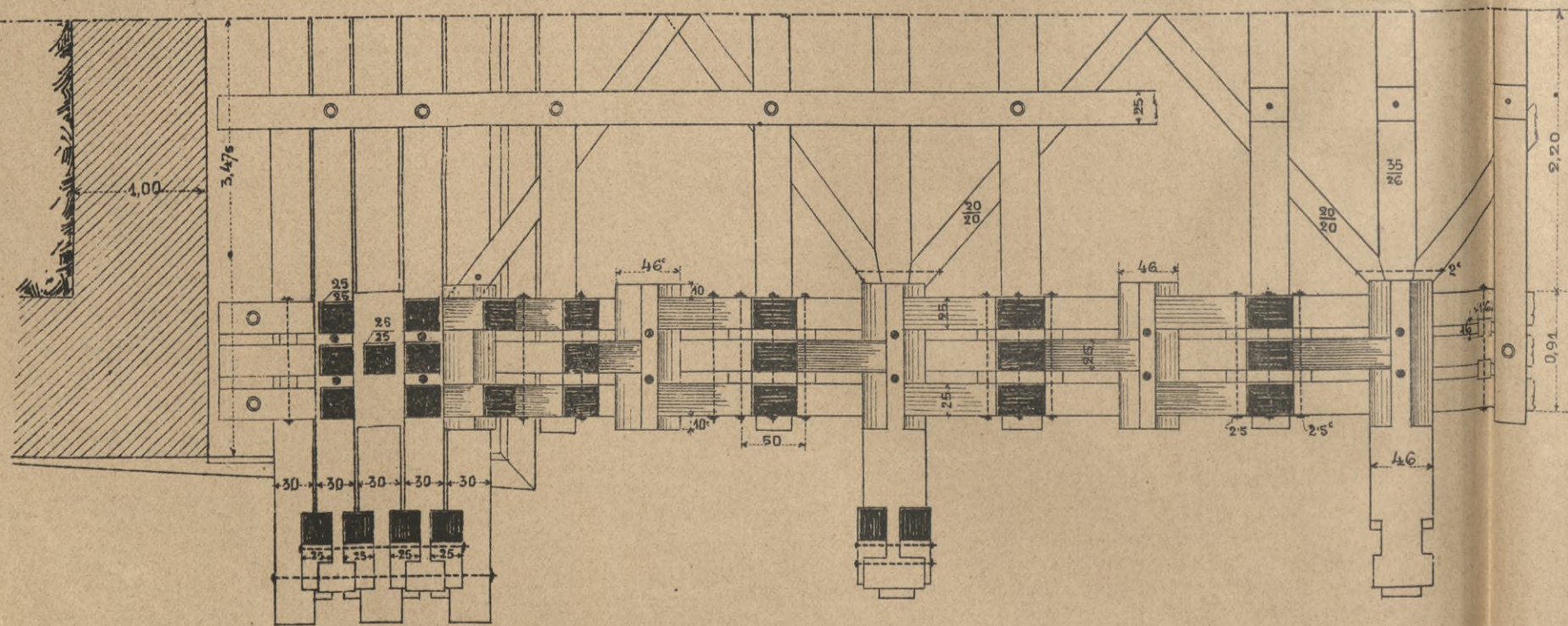

rys.2. Przekrój

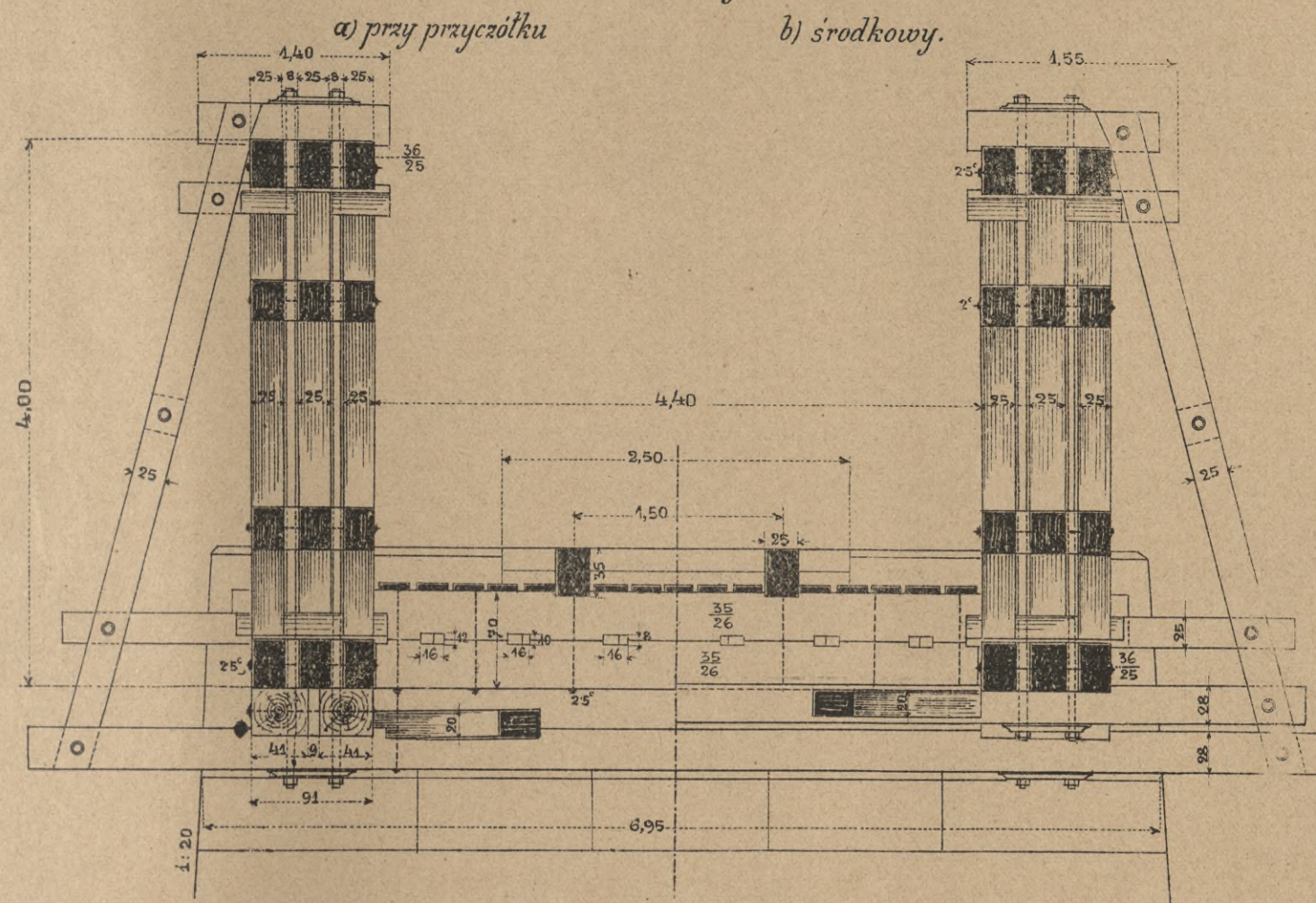

rys.4. Widok z góry.

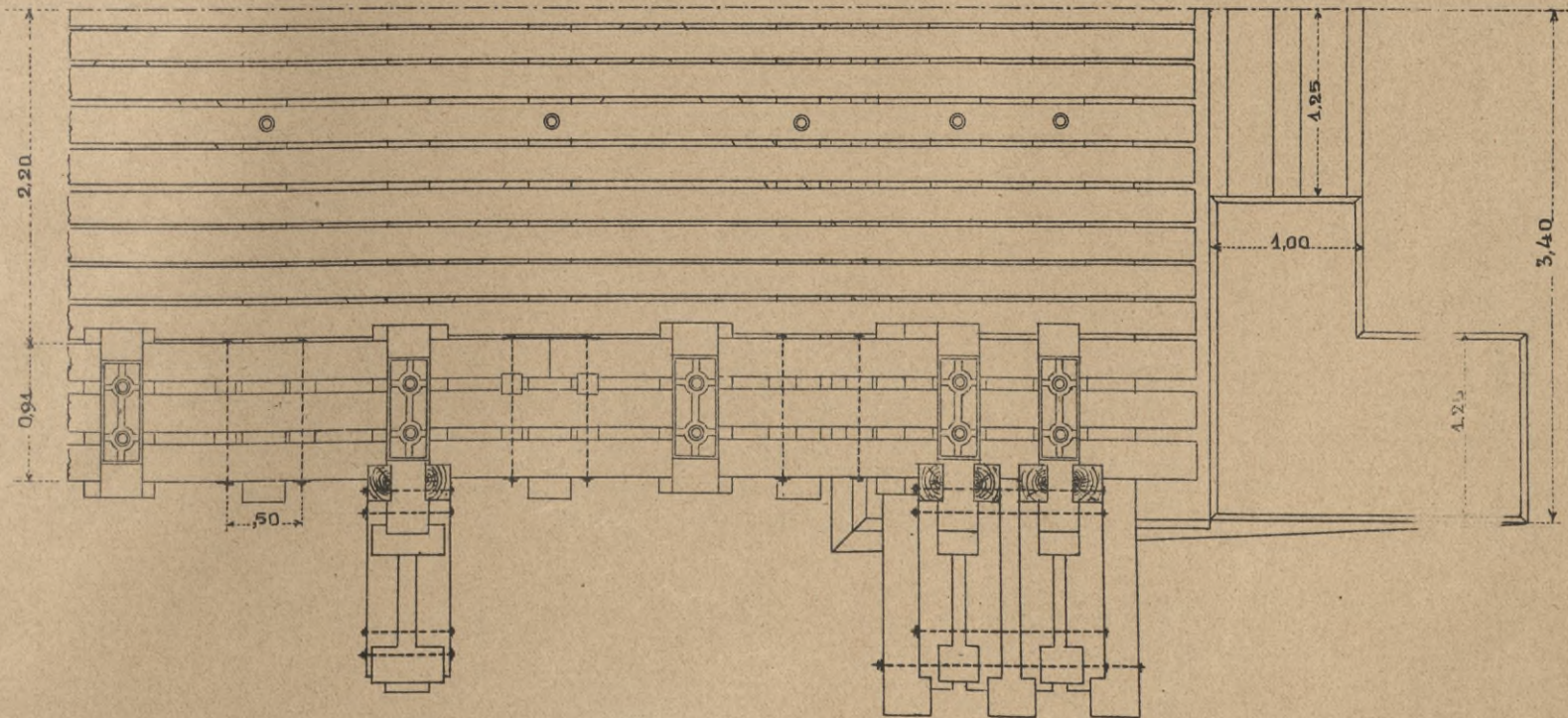

Rusztowanie mostu Morand i Lafayette w Lugdunie

Rys. 1a. Widok

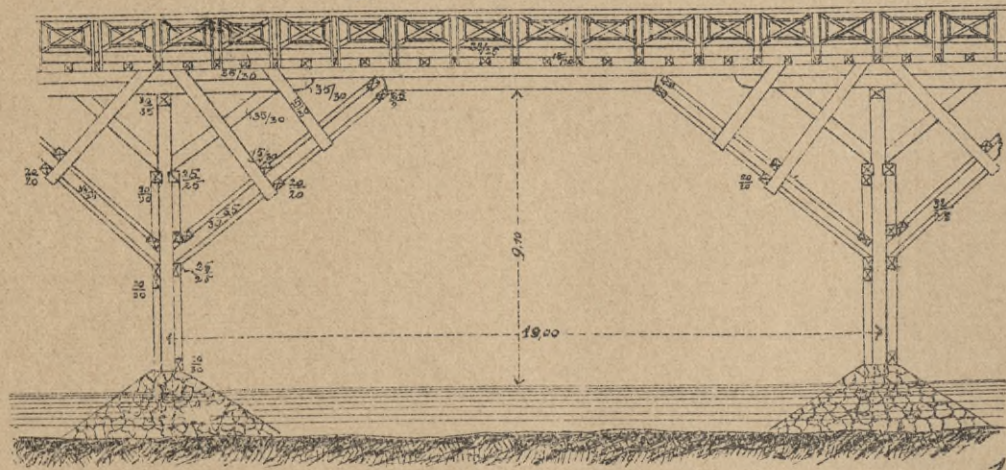

1:200

Rys. 1b. Powzroj

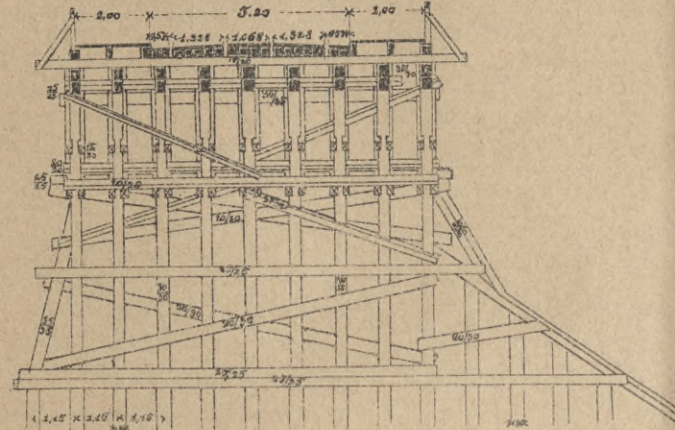

Rys. 2a. Przekroj

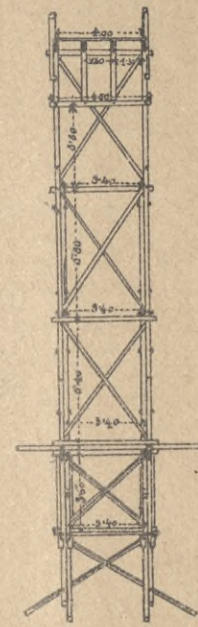

1:300

Most linczasowy nad Persiną w Tyrolu

Rys. 2a. Widok

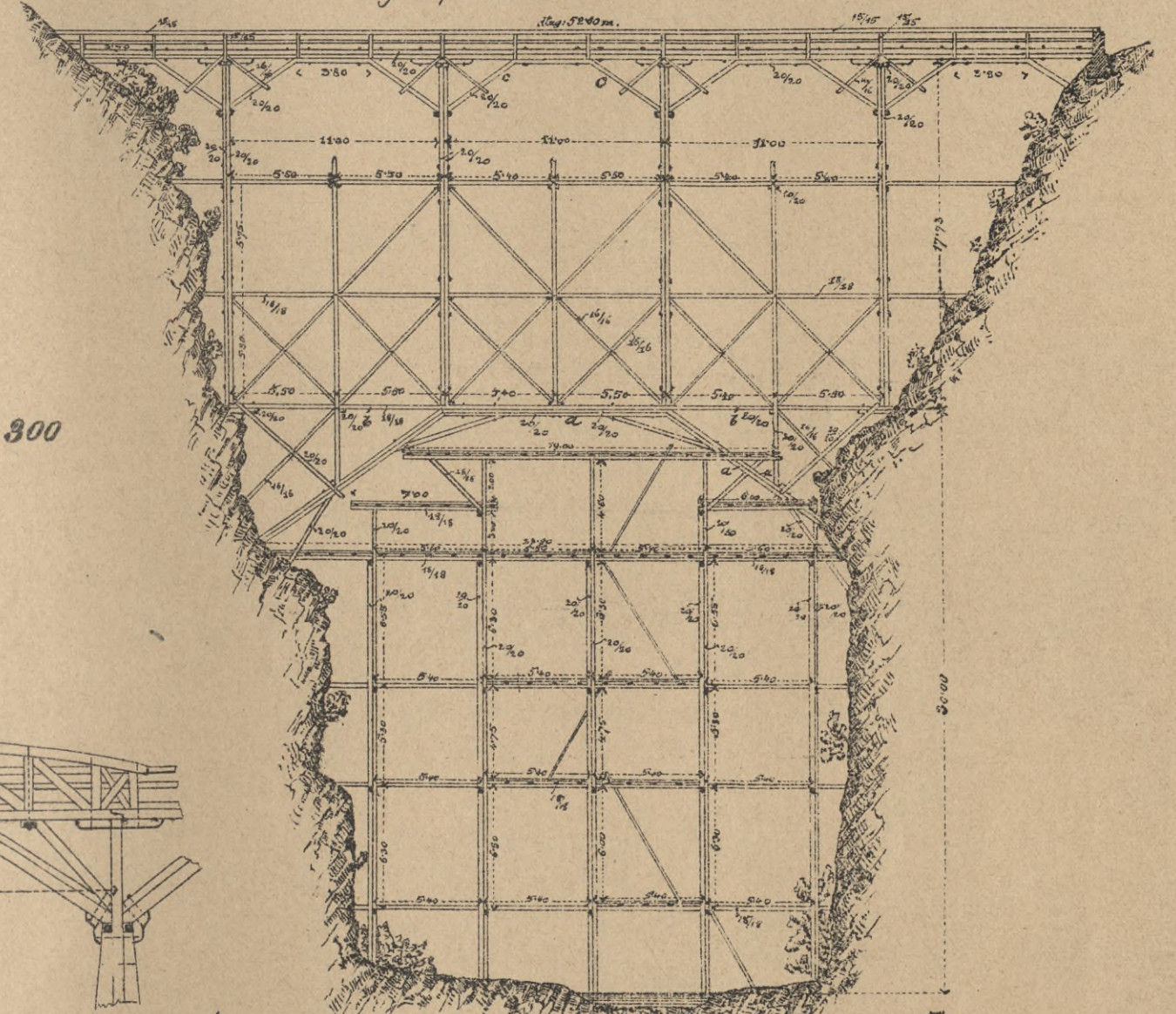

Mosty drogowe drewniane w Norwegii

Rys. 3

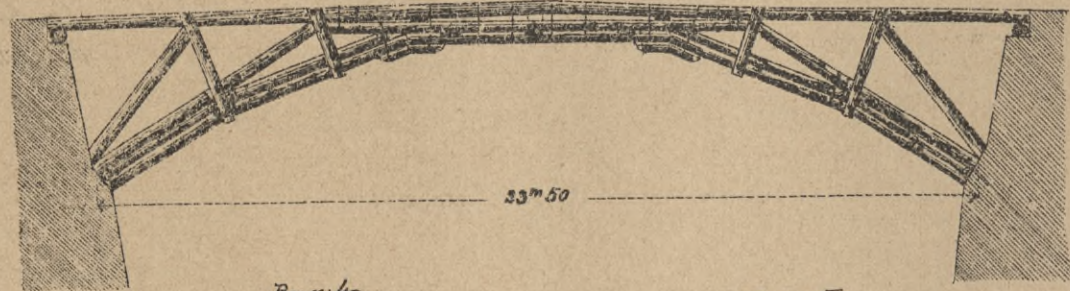

Rys. 4

Rys. 5

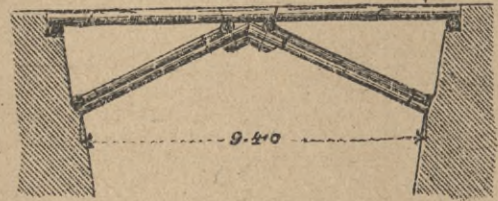
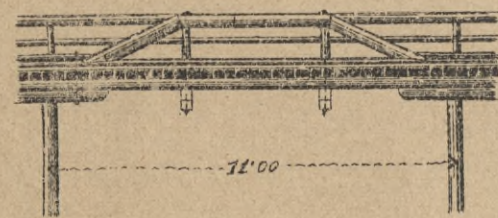

1:800

Rys. 6

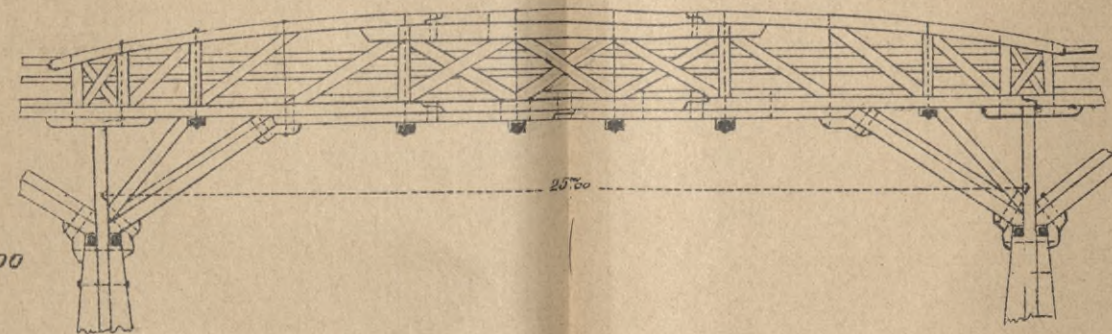

Rusztowanie mostu Franciszka Karola w Gradcu

Rys. 8a. Widok

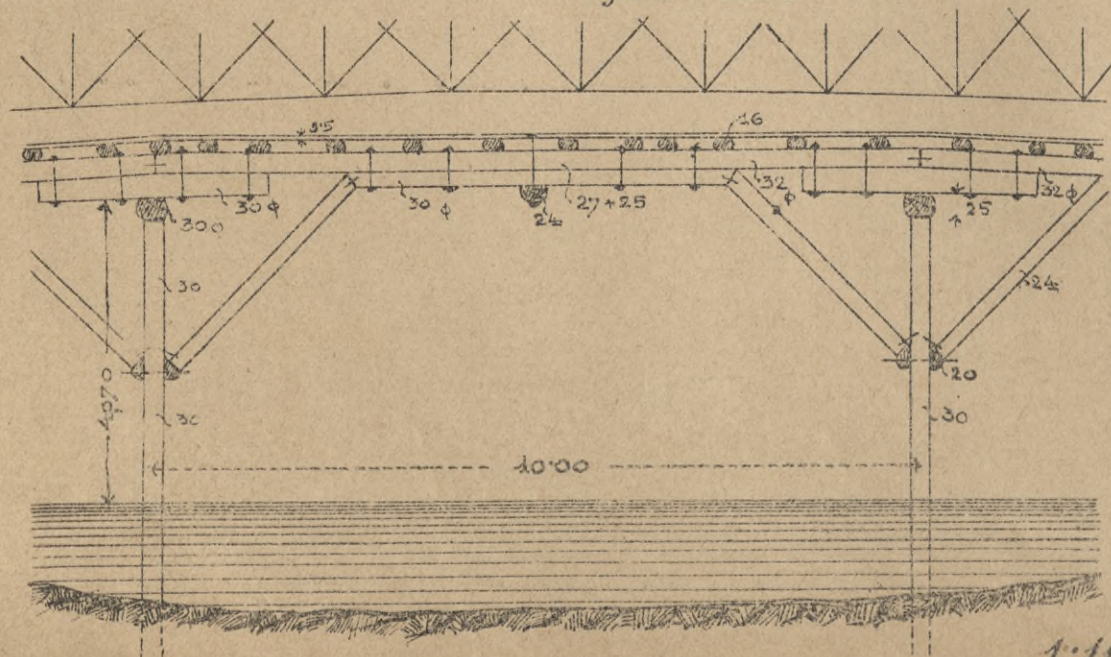

1:100

Rys. 8b. Przekroj

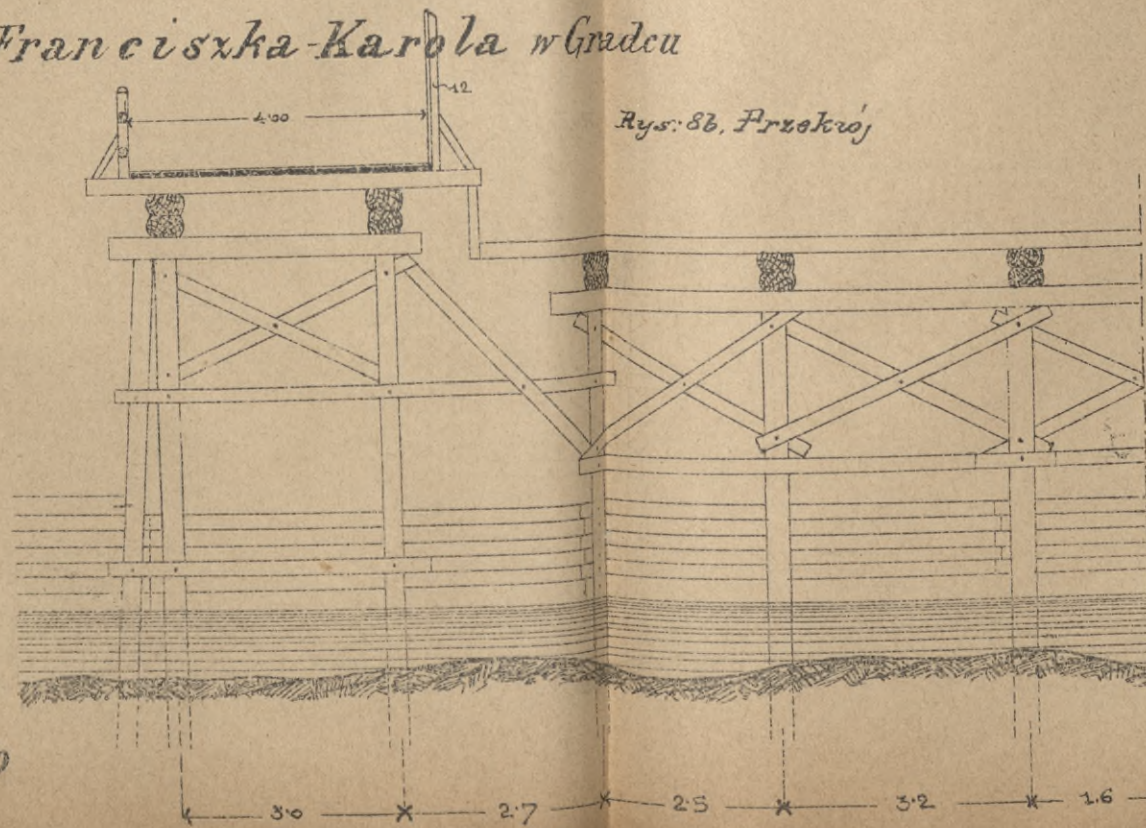

Rys. 2b. Przet poziomy

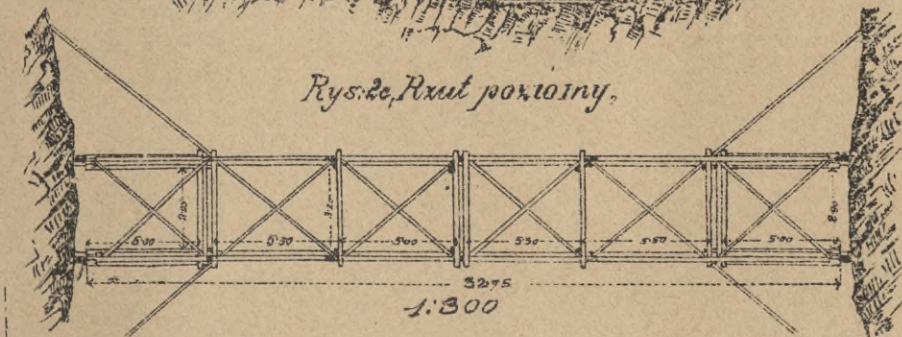

1:300

Rys. 7. Most drogowy w Norwegii

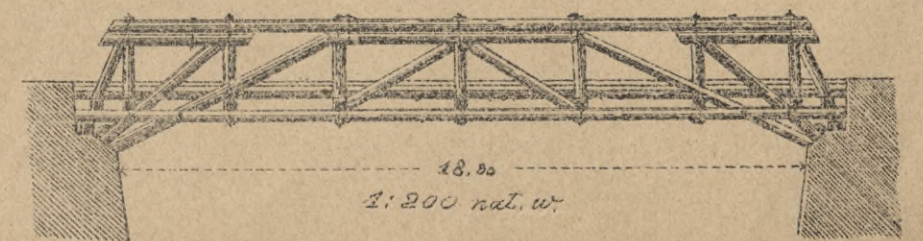

1:200 nat. w.

RUSZTOWANIE WIADUKTU NAD WELTAWĄ W CERVÉNIE.

Tab. 66,

Rys. 1a, Widok

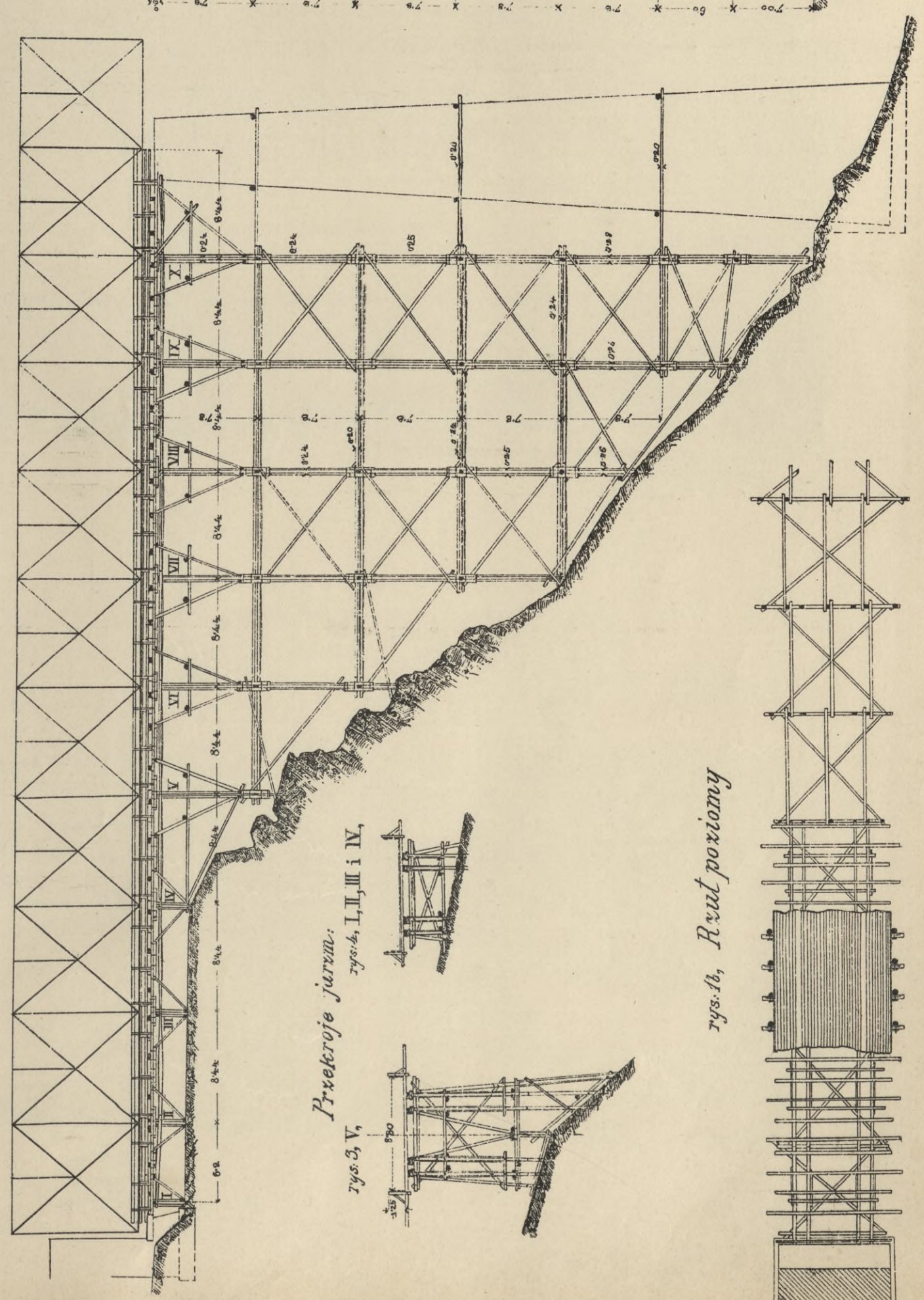

Przekroje jaram:
rys. 3, V,
rys. 4, I, II, III i IV,

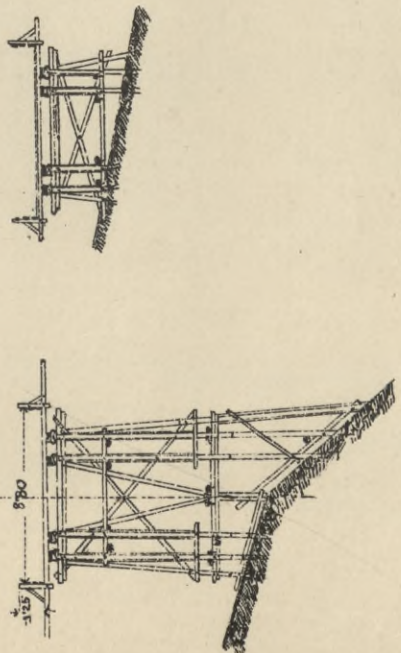

rys. 1b, Rzut poziomy

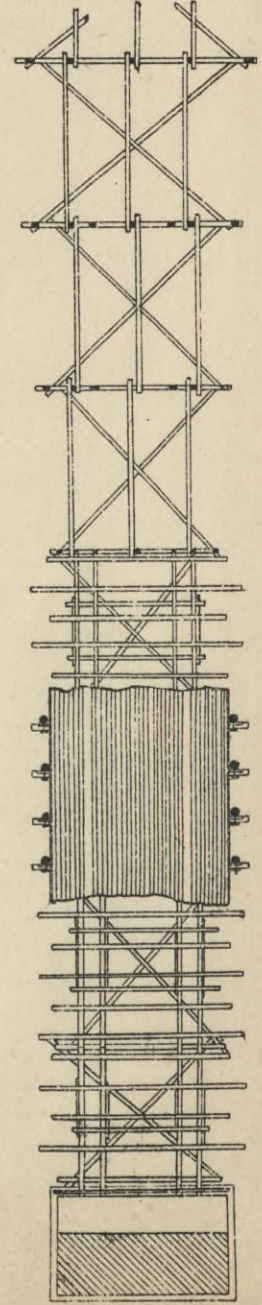

rys. 2, Przekroj jarma X,

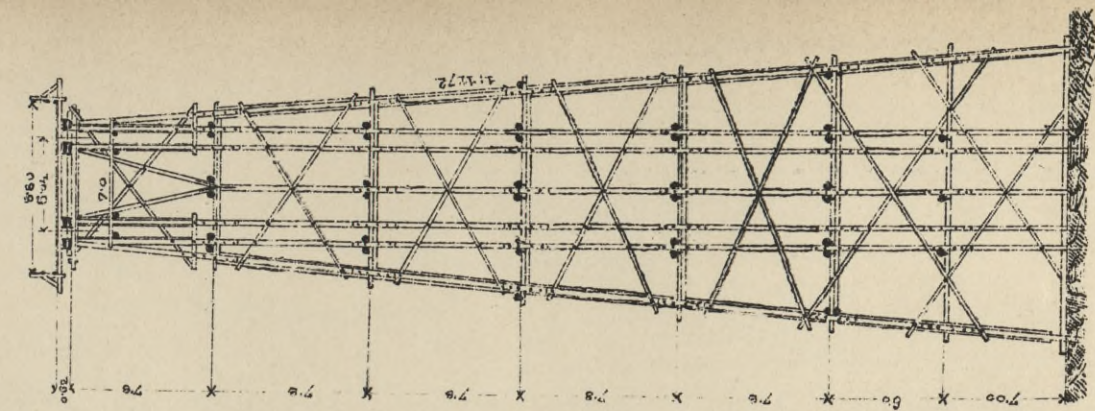

Rys. 1.

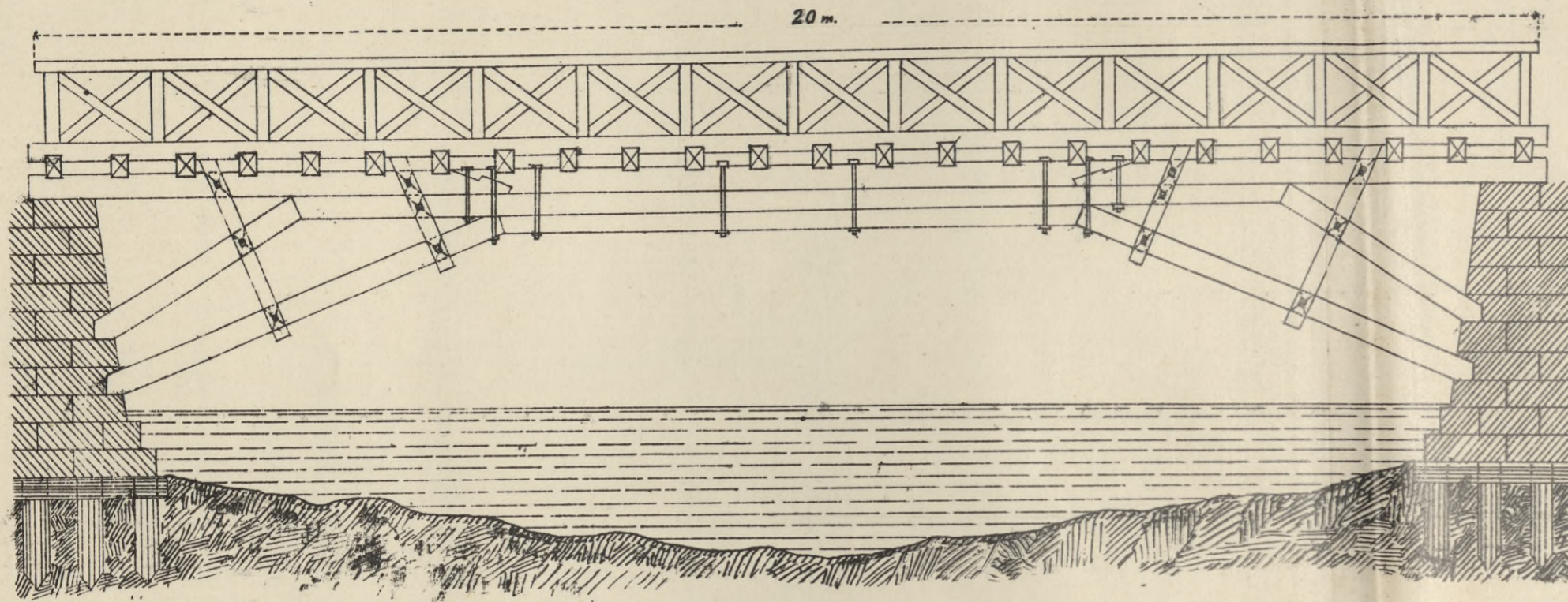

1:75.

Rys. 2.

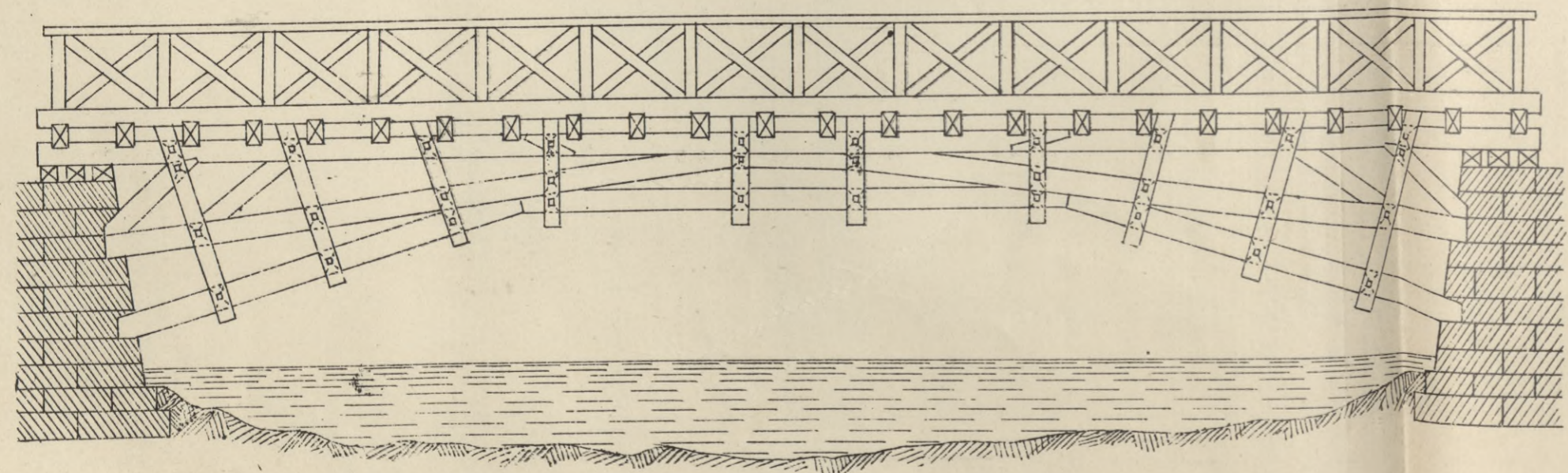

1:75.

Most nad Hère.

Rys. 3a. Przekrój podłużny.

Widok.

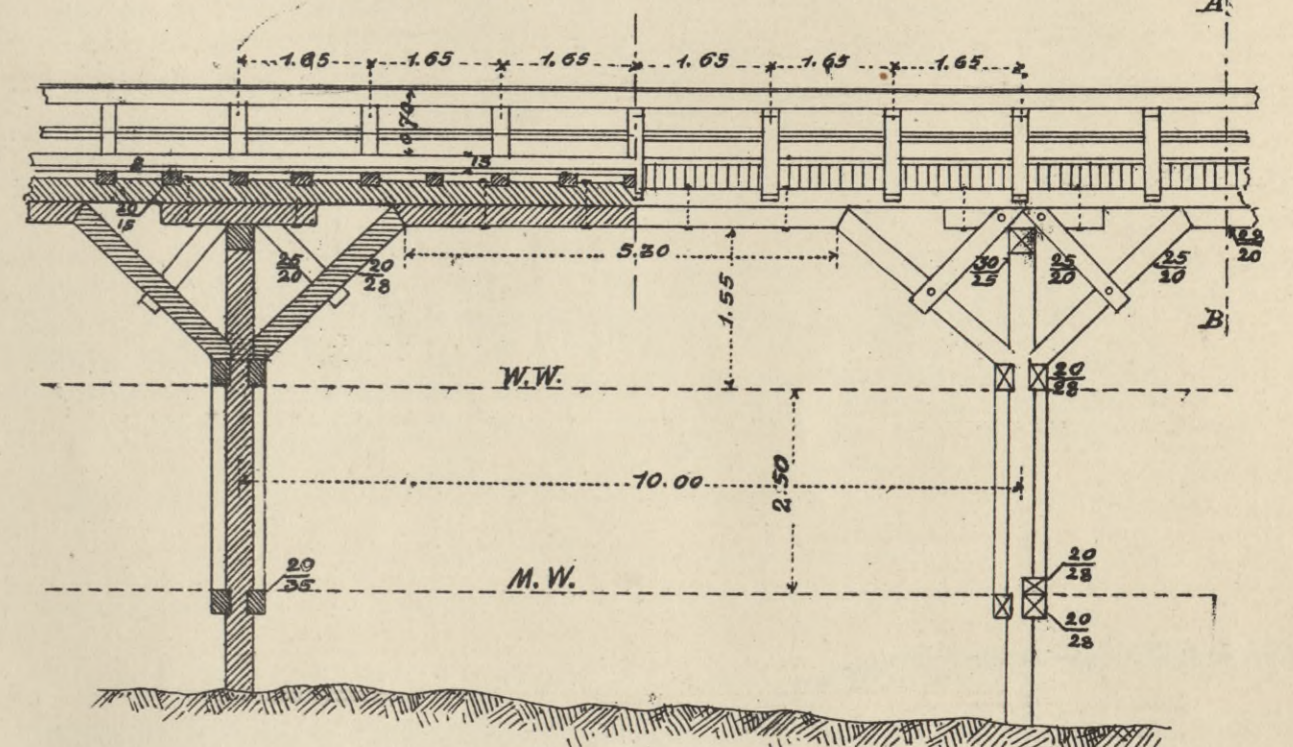

1:100.

Przekrój A-B.

Rys. 3b.

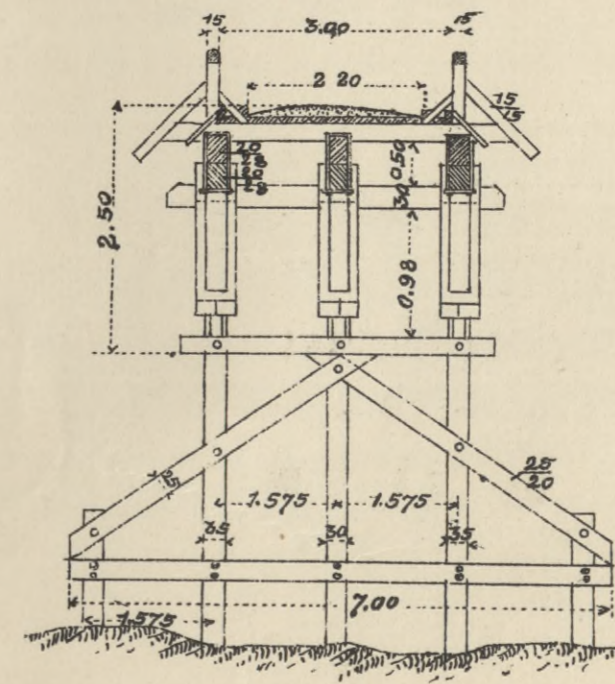

Rys. 3c.

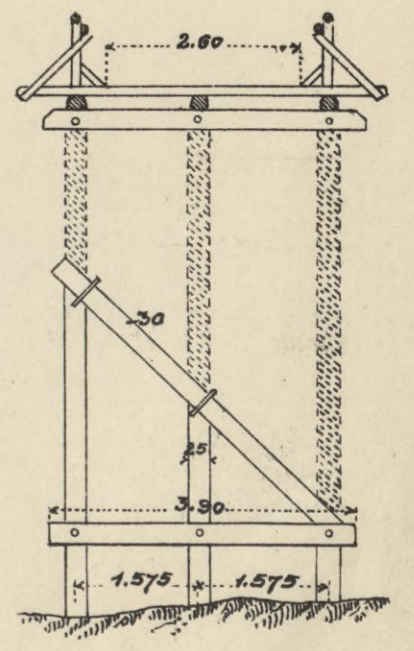

1:100.

MOST DREWNIANY ROZPOROWY

Rys. 1. Widok.

Przekrój podłużny c

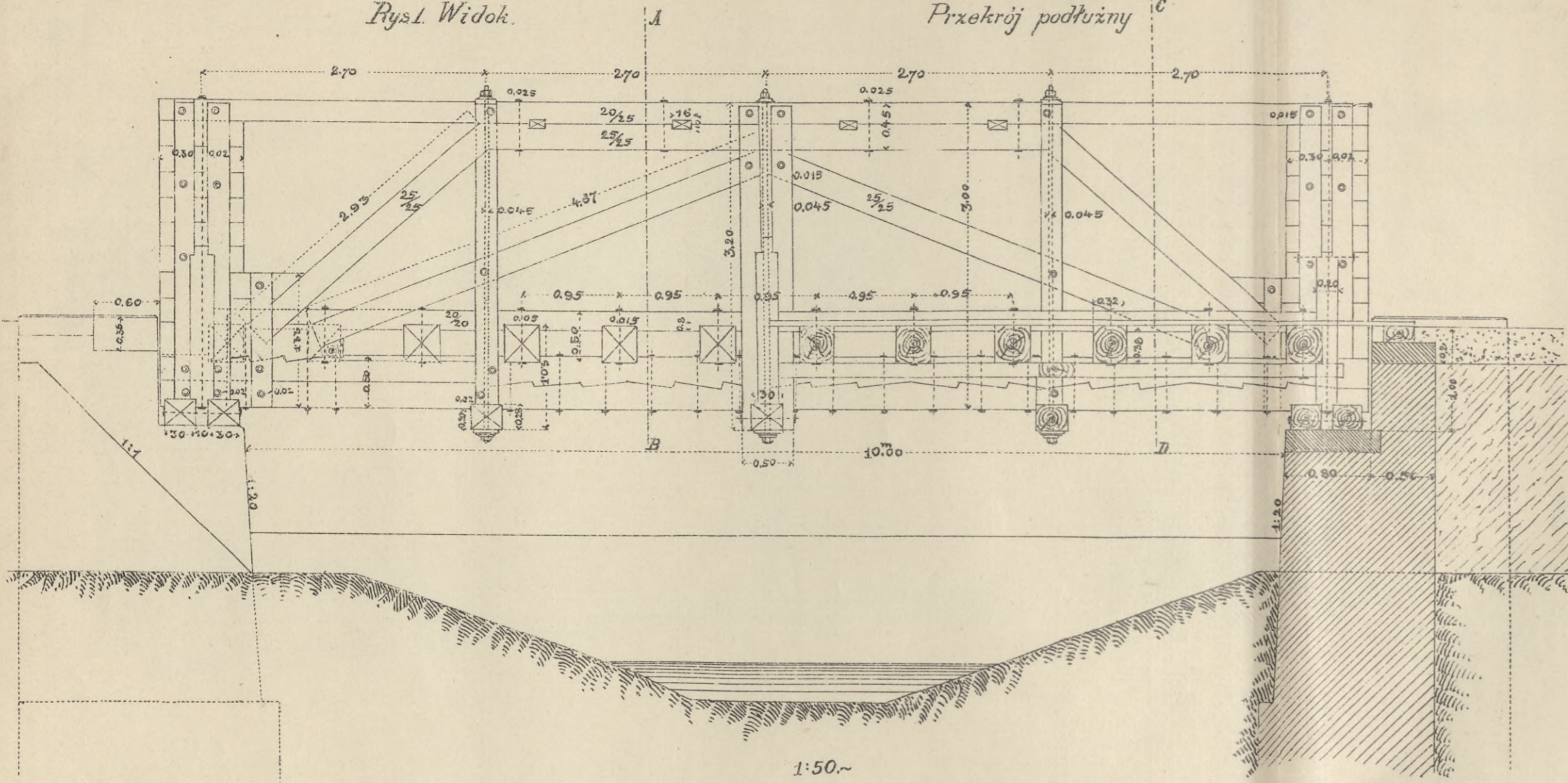

Rys. 2. Rzut poziomy.

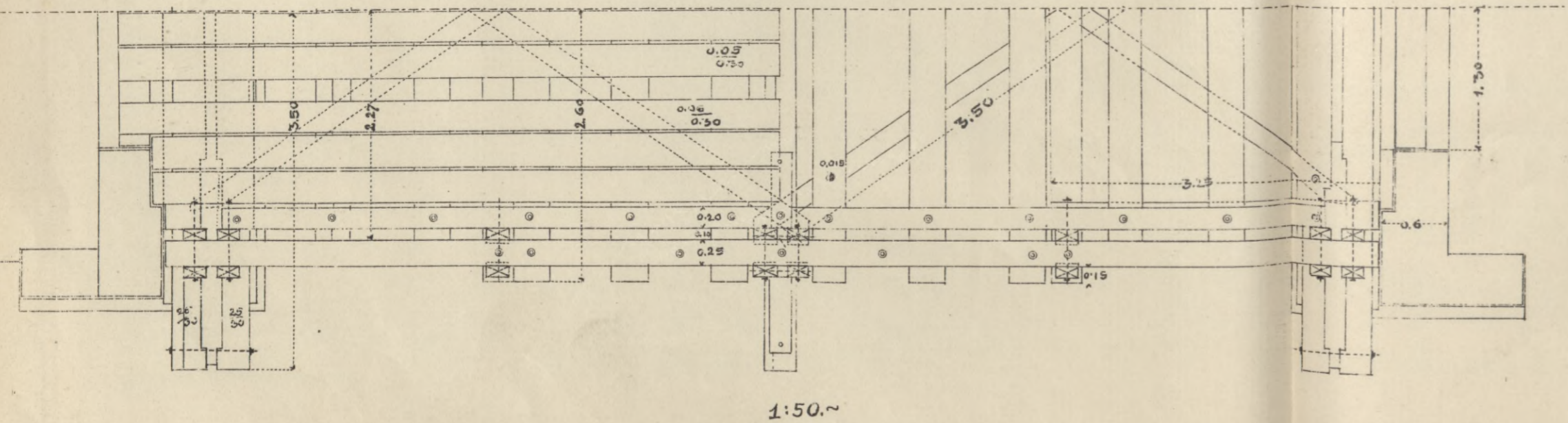

Rys. 3. Przekrój poprzeczny.

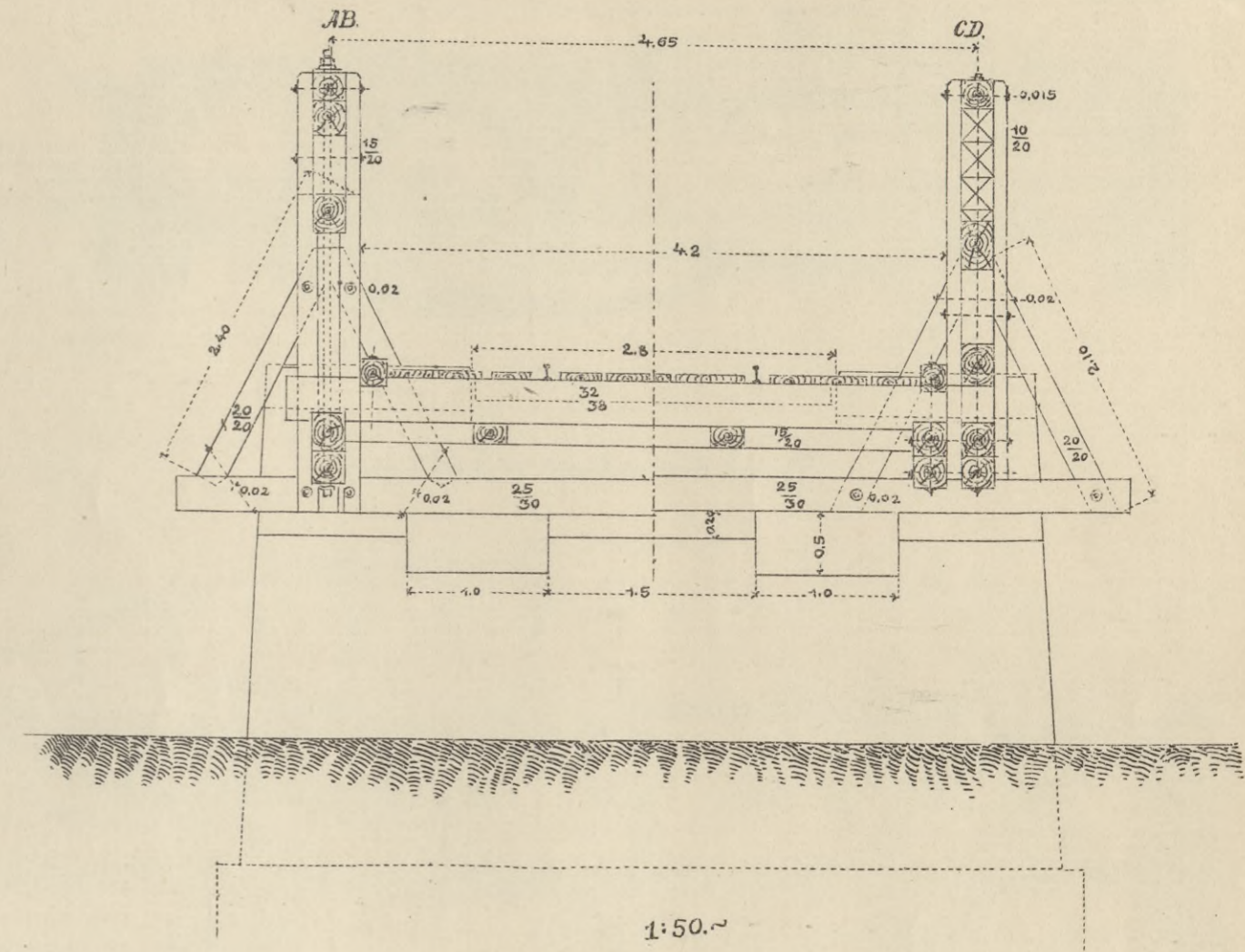

Rys. 4. Skośnogł.

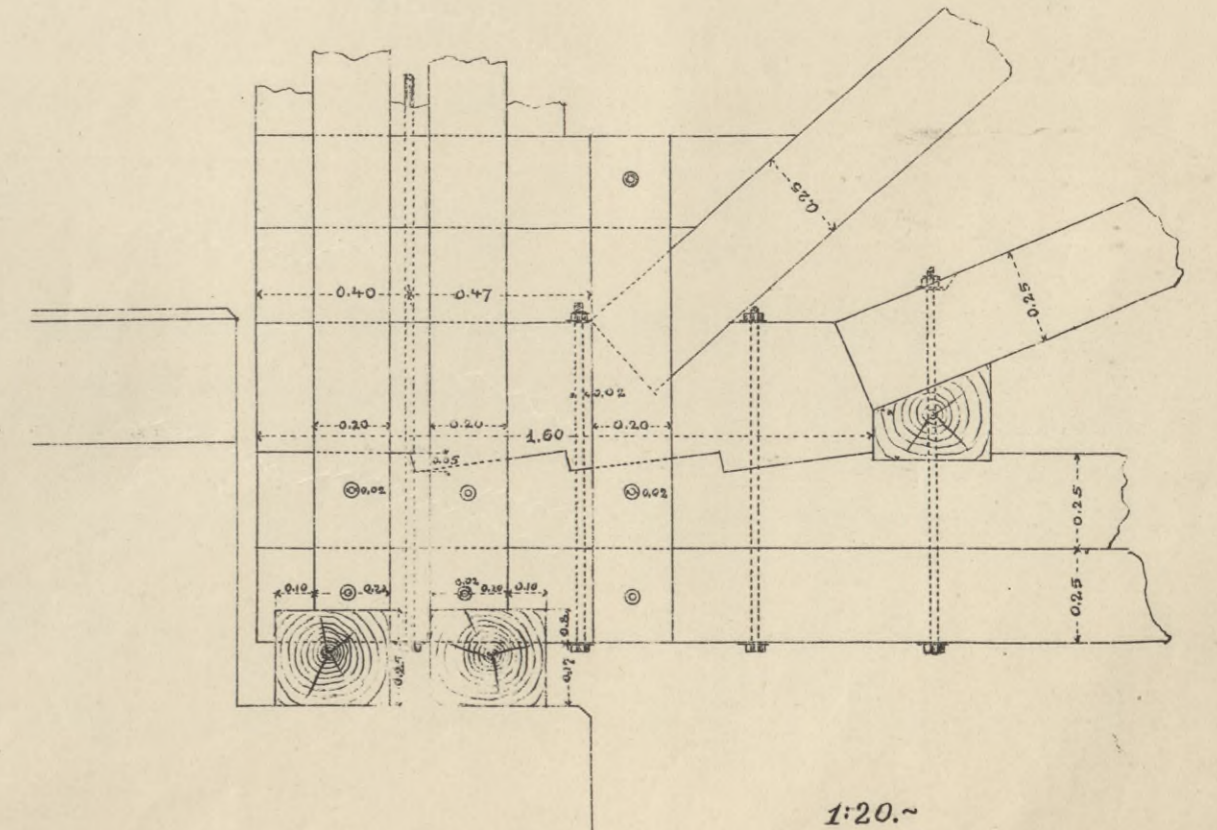

Rys. 1. Przekrój podłużny

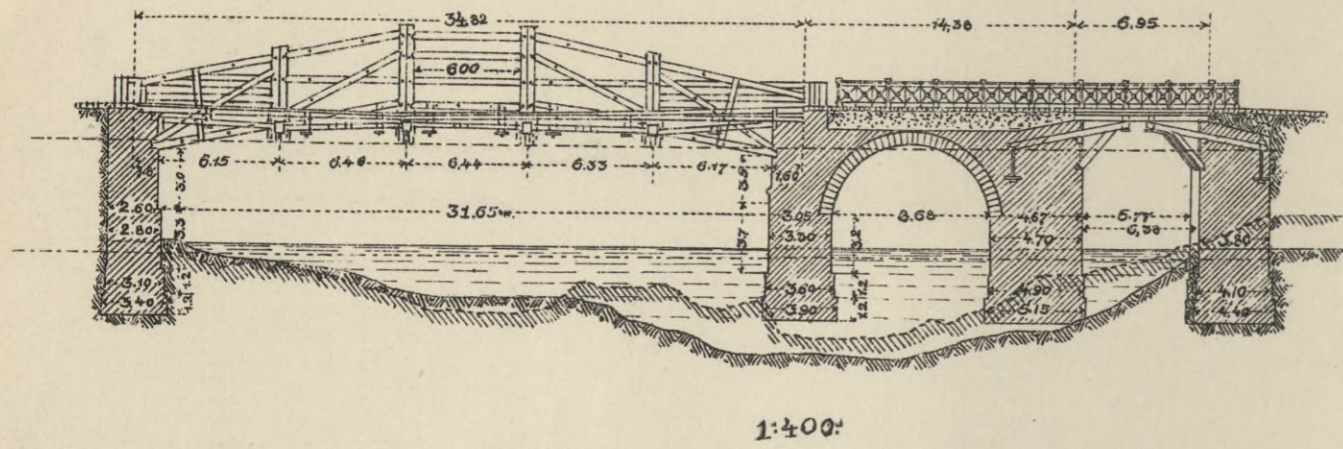

Rys. 2. Przekrój poprzeczny

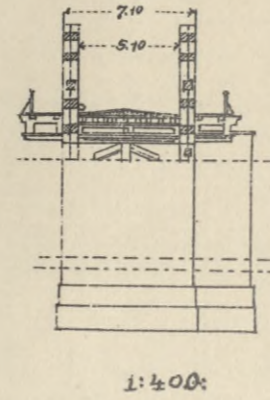

Rys. 3. Przekrój podłużny

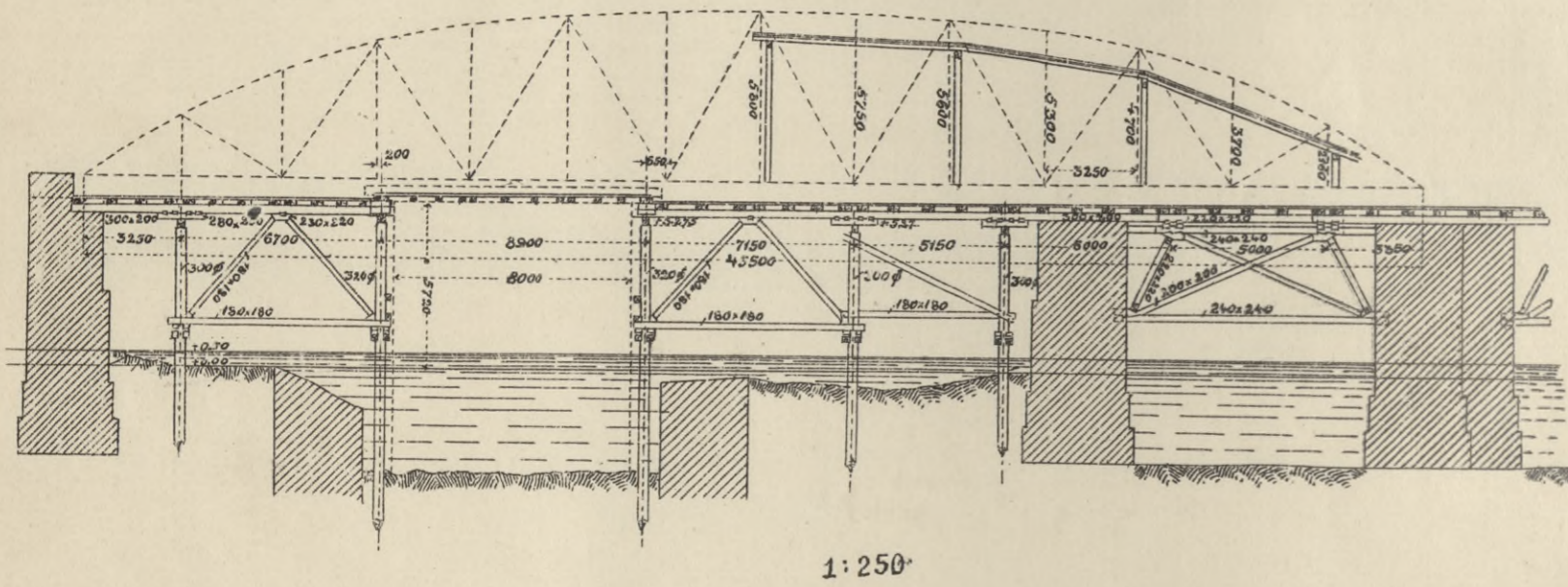

Rys. 4. Przekrój poprzeczny

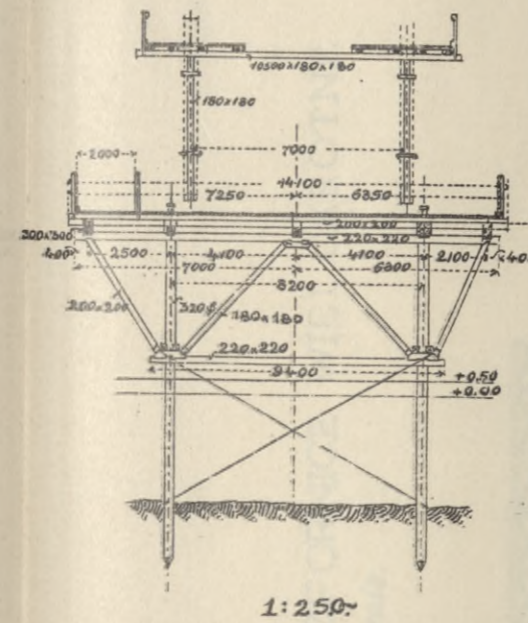

Rys. 7.

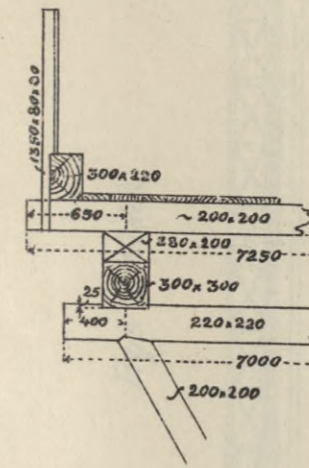

Szczegóły

Rys. 8.

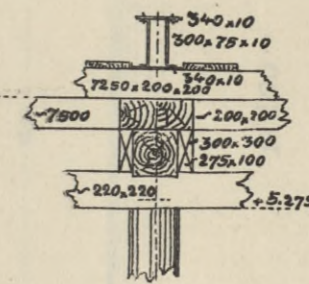

Rys. 9.

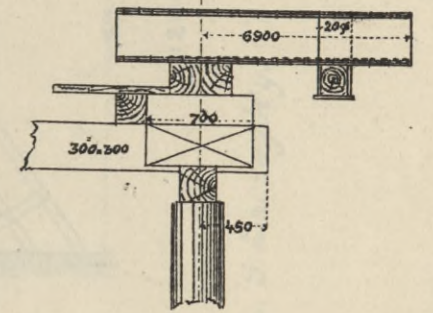

Rys. 10.

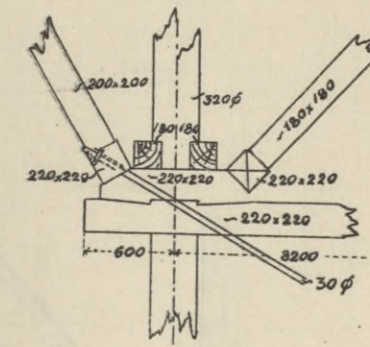

Rys. 11.

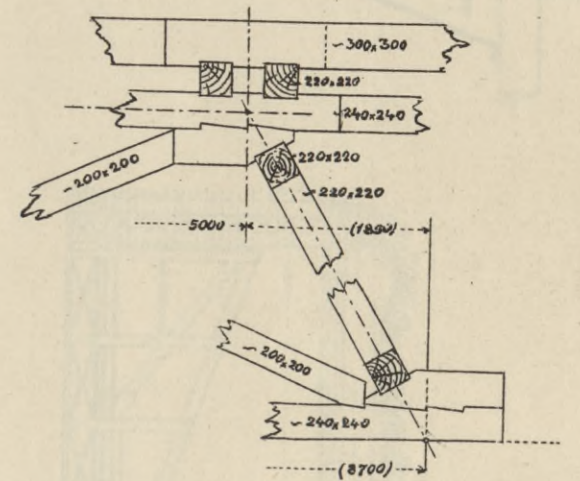

Rys. 5. Rzut poziomy

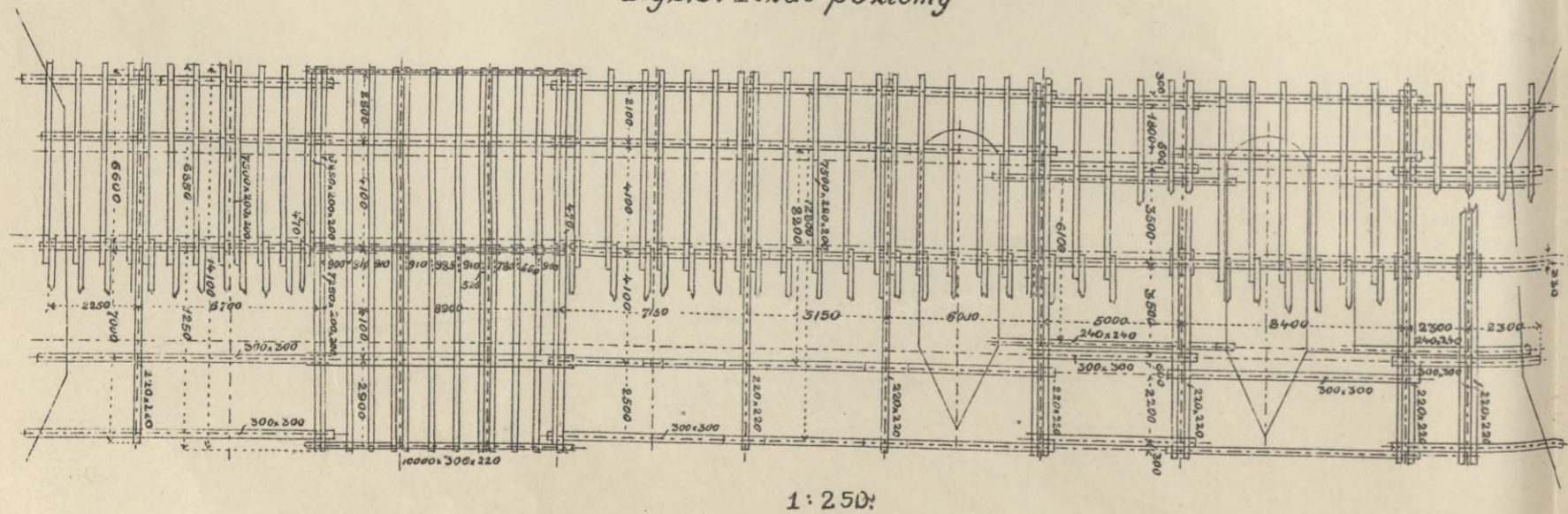

Rys. 6. Przekrój

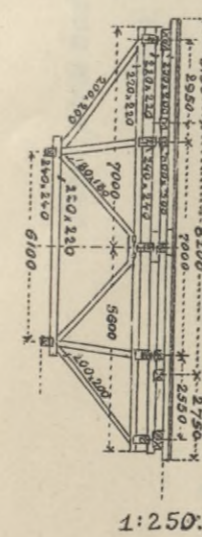

Rys. 12.

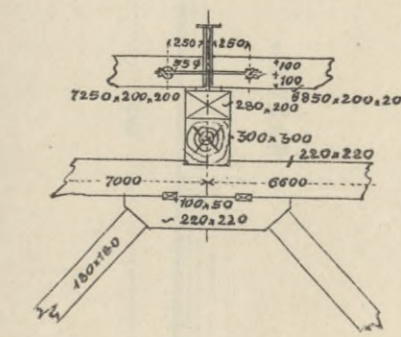

Rys. 13.

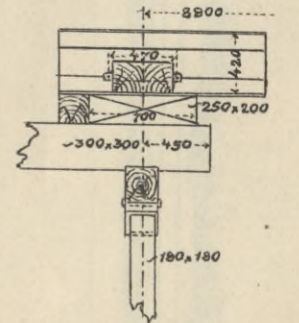

Skala dla szczegółów 1:50.

Rys. 1. Widok.

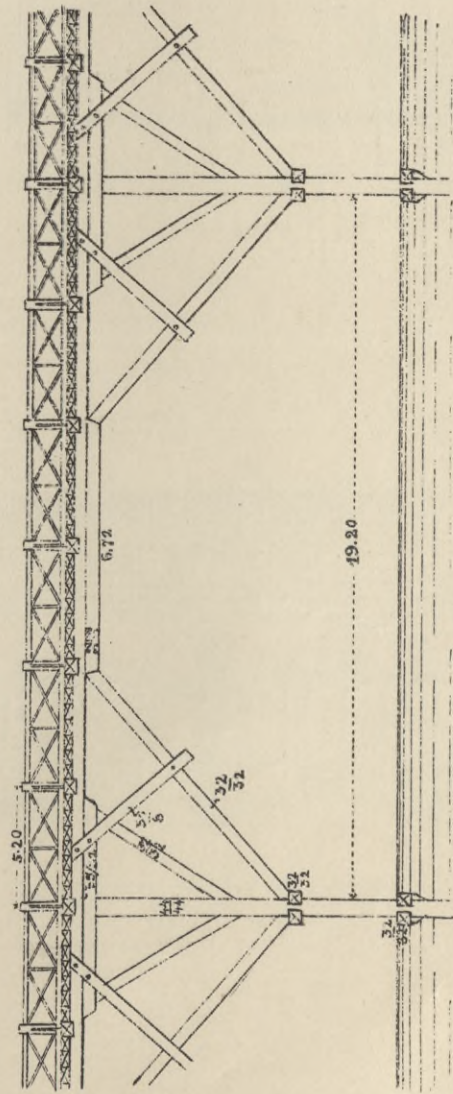

1:200.~

Rys. 2. Widok.

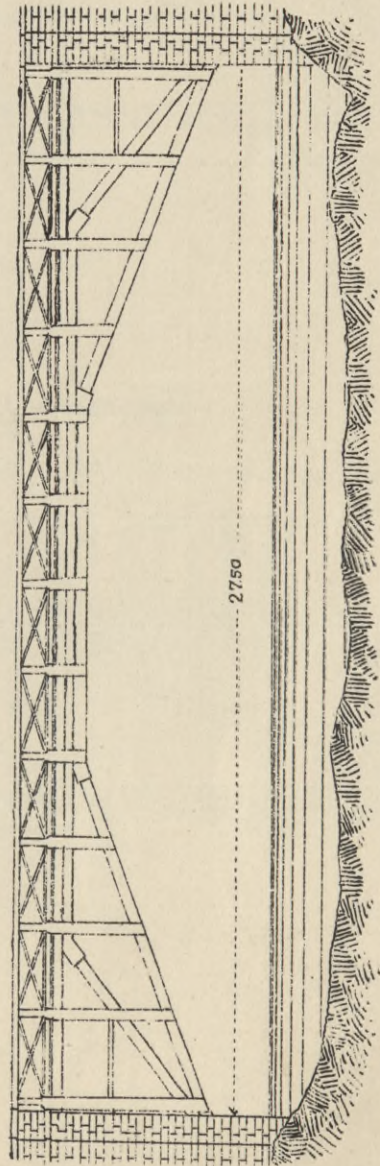

1:200.~

Rys. 3. Widok.

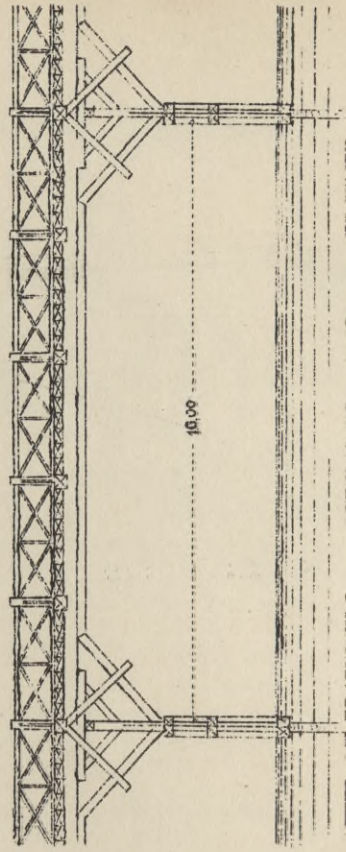

1:200.~

Rys. 4. Widok.

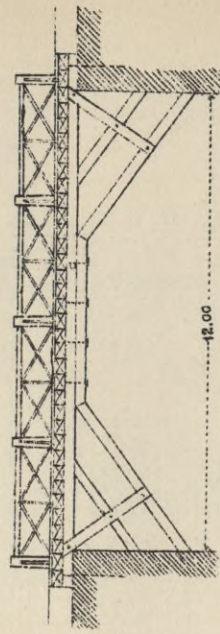

1:200.~

Rys. 5. Szczyt.

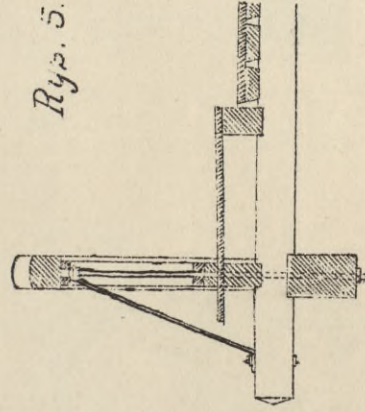

1:40.~

Typy Mostów drewnianych w kantonie Bernenskim

Most o rozpiętości 32-38 m.

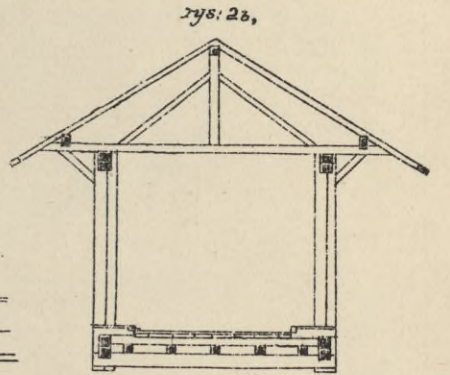
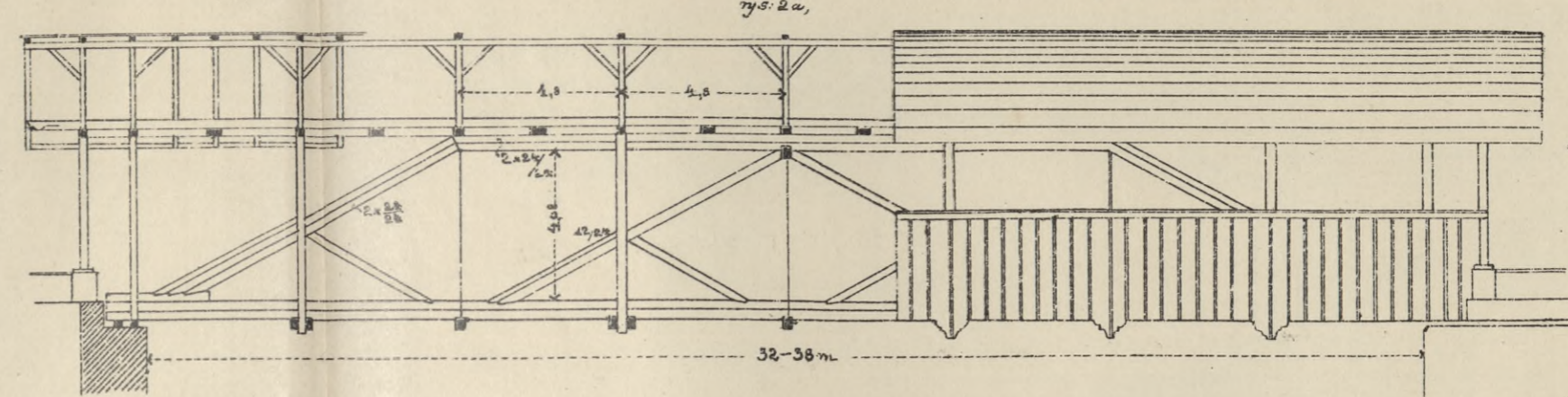
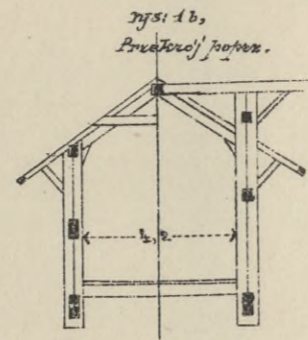
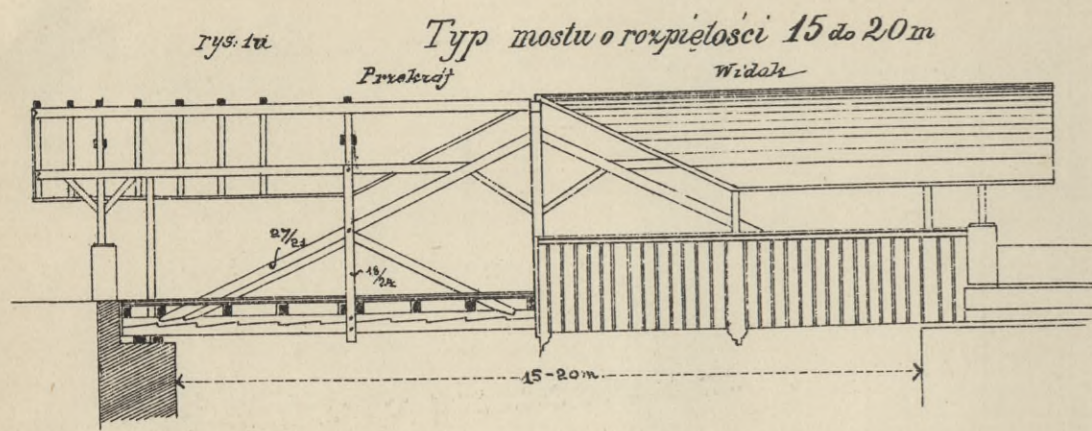

rys. 3a, Typ mostu o rozpiętości 15-21 m

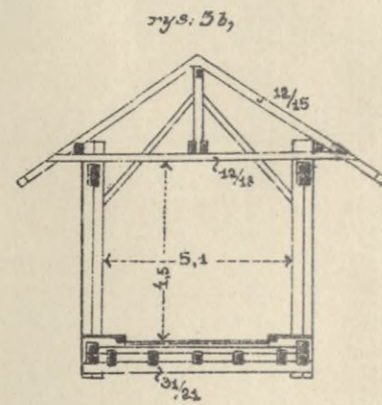
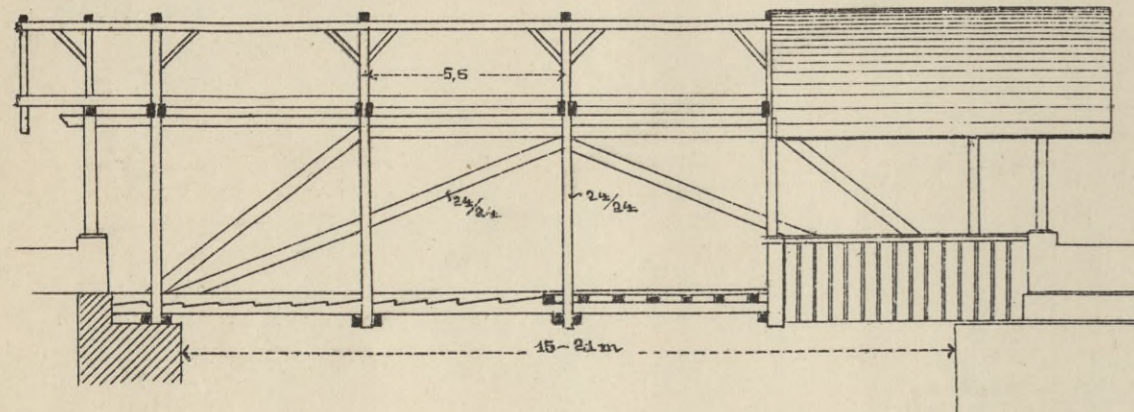

rys. 4a, Most o rozpiętości 22-32 m.

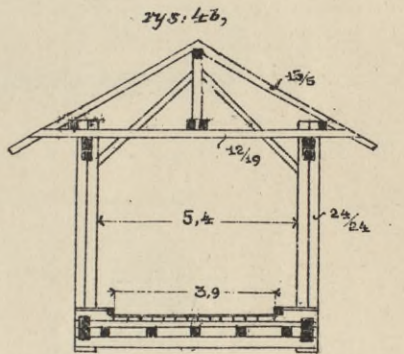
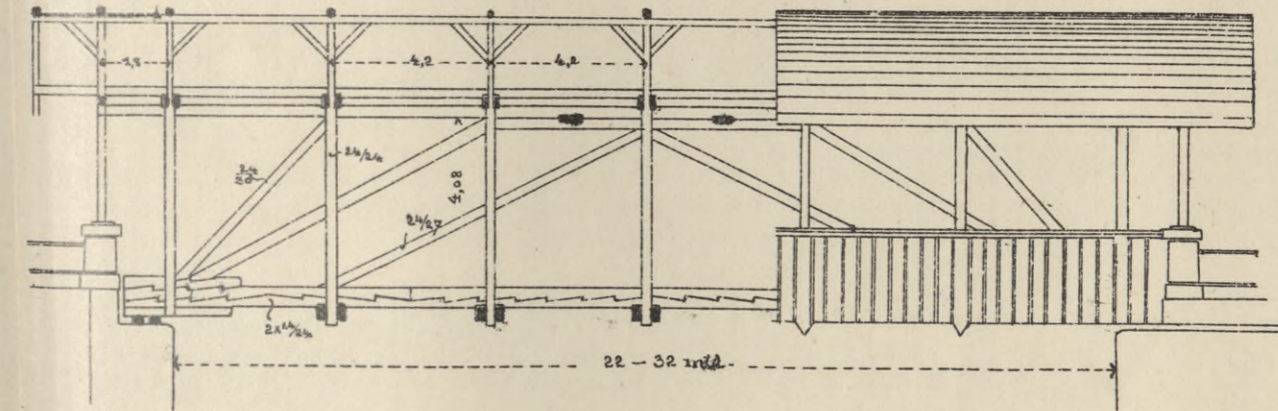

Typ mostu o rozpiętości 25-32 m

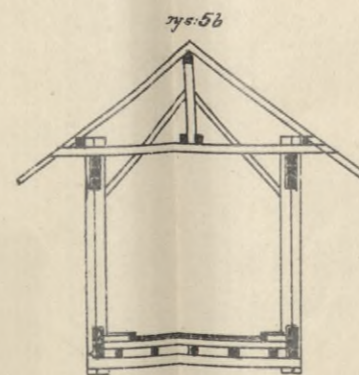
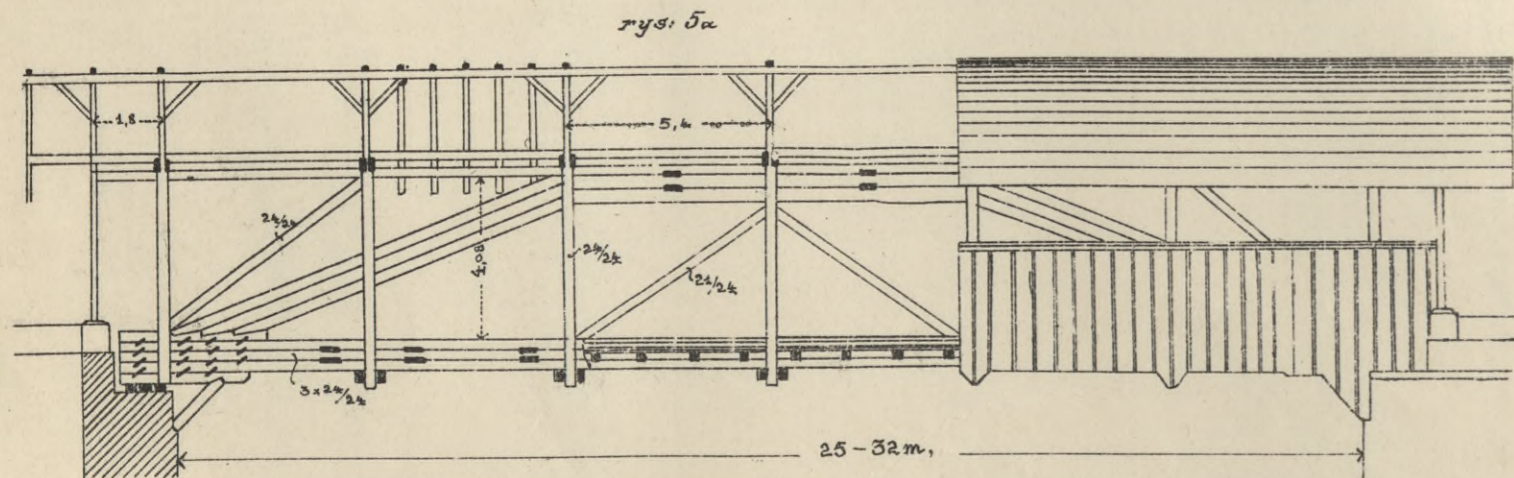

rys. 6, Most drogowy między Chur a Thusis w Szwajcaryi

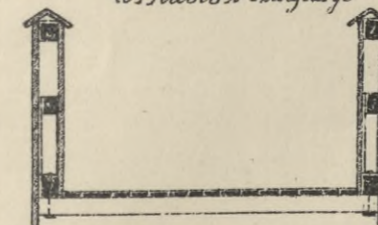

Most prowickorny nad Pad-m w Casalmaggiore

rys. 7a, Przekrój poprzeczny

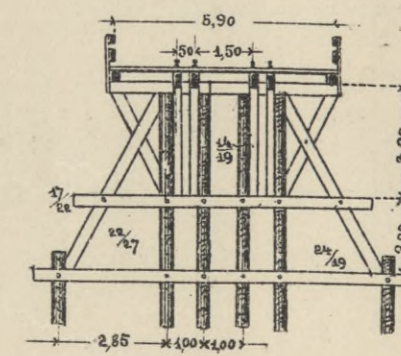

rys. 7b, Widok

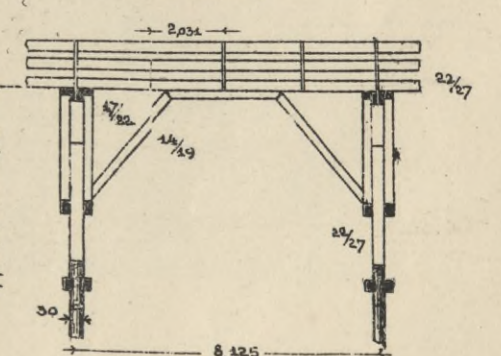

ROZPORNICE TRAPEZOWE

Rys. 1a. Most drogowy nad koleją Lehrte-Hildesheim.
Przekrój podłużny i widok.

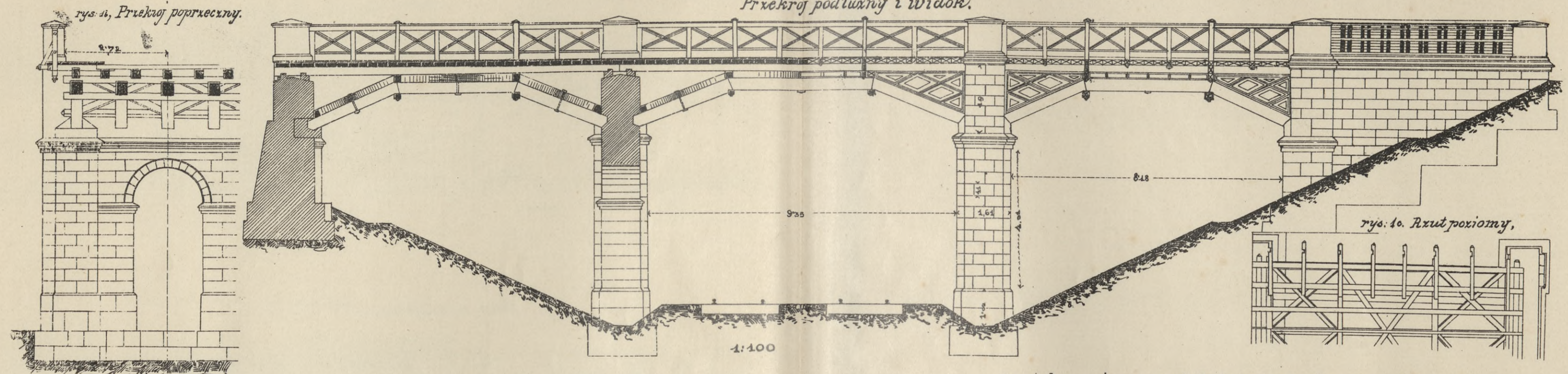

rys. 2c, Skrzegóły rozpornic.

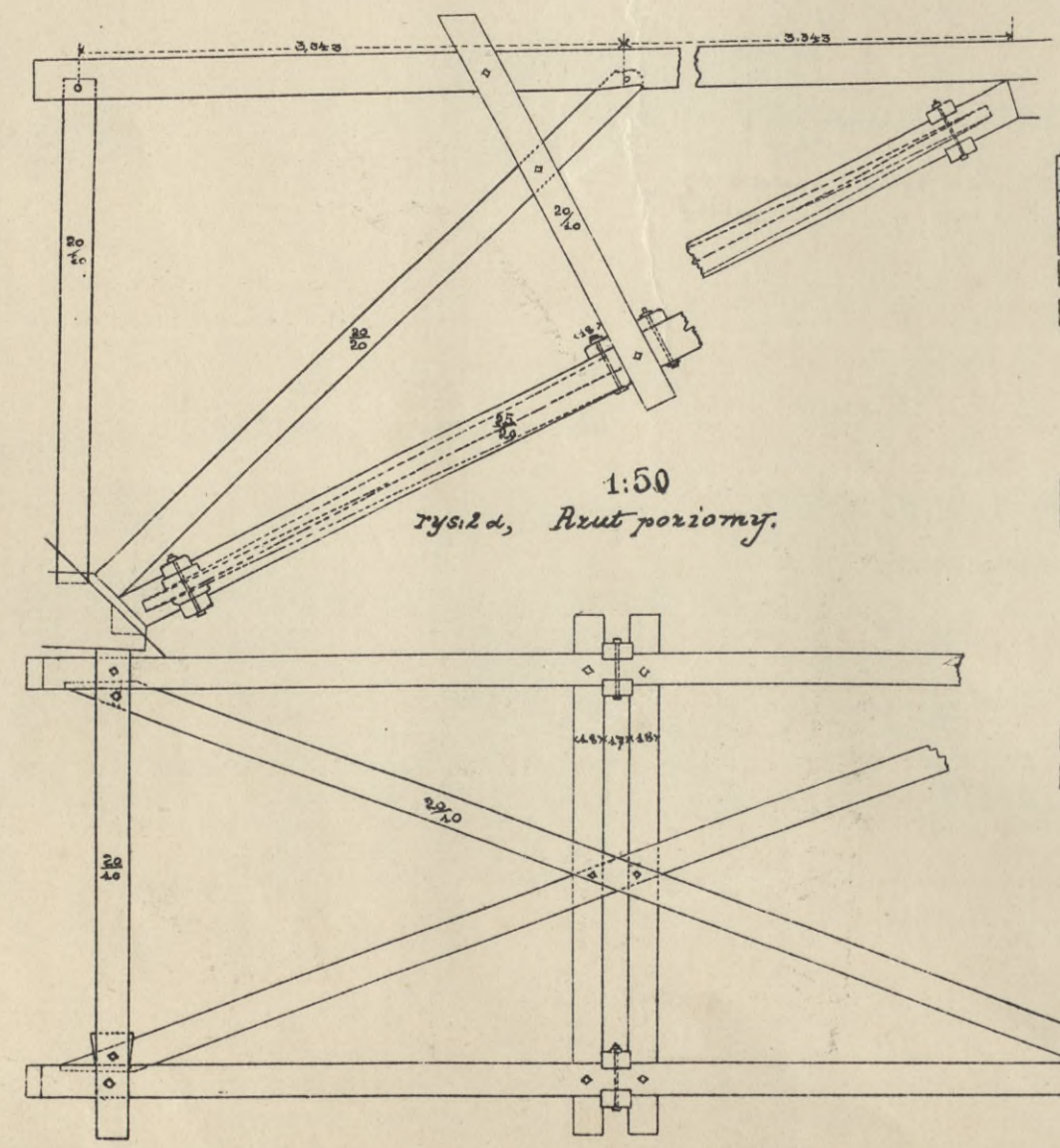

rys. 2e, Przekrój poprzeczny

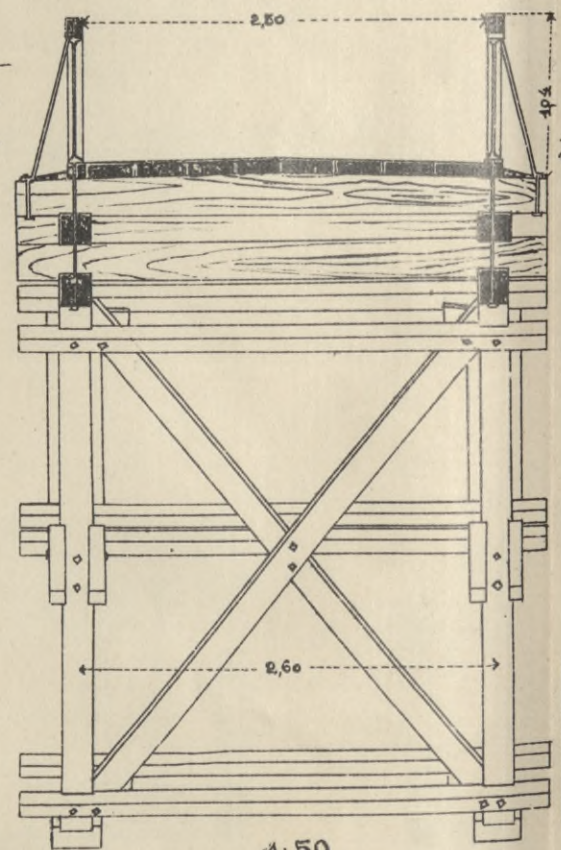

rys. 2f, Skrzegóły trawnika,

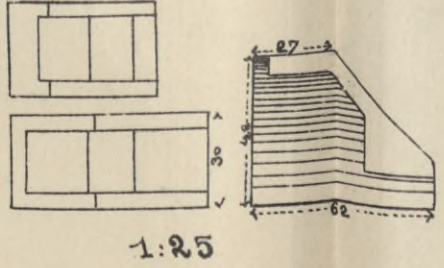

Most drewniany nad koleją paryżko-versalską,

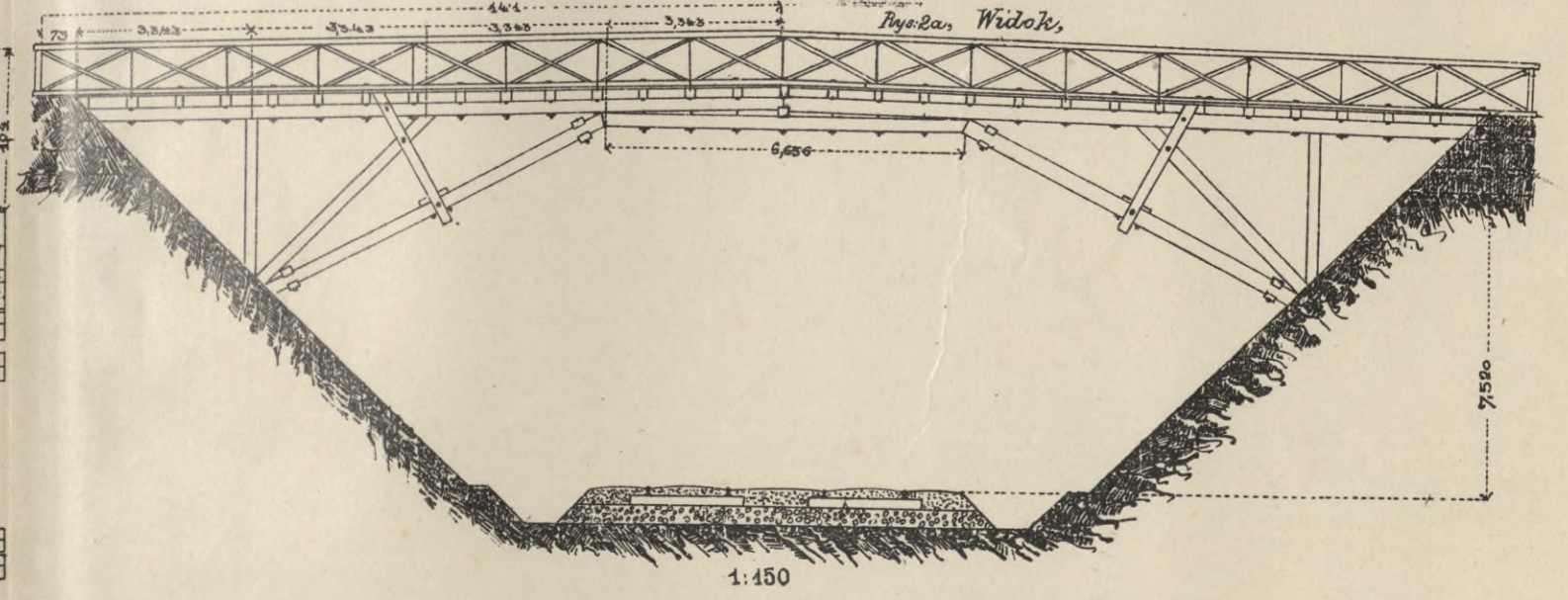

Rys. 2b, Rzut poziomy,

rys. 2g-z, Skrzegóły kraty,

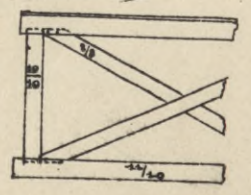
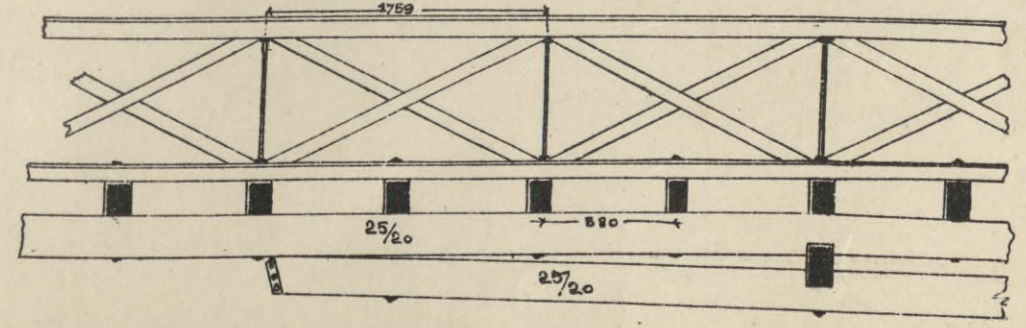

ROZPORNICA WIELOKROTNA.

Most nad Sekarem pod Kainstadt.
Przekrój podłużny.

Widok.

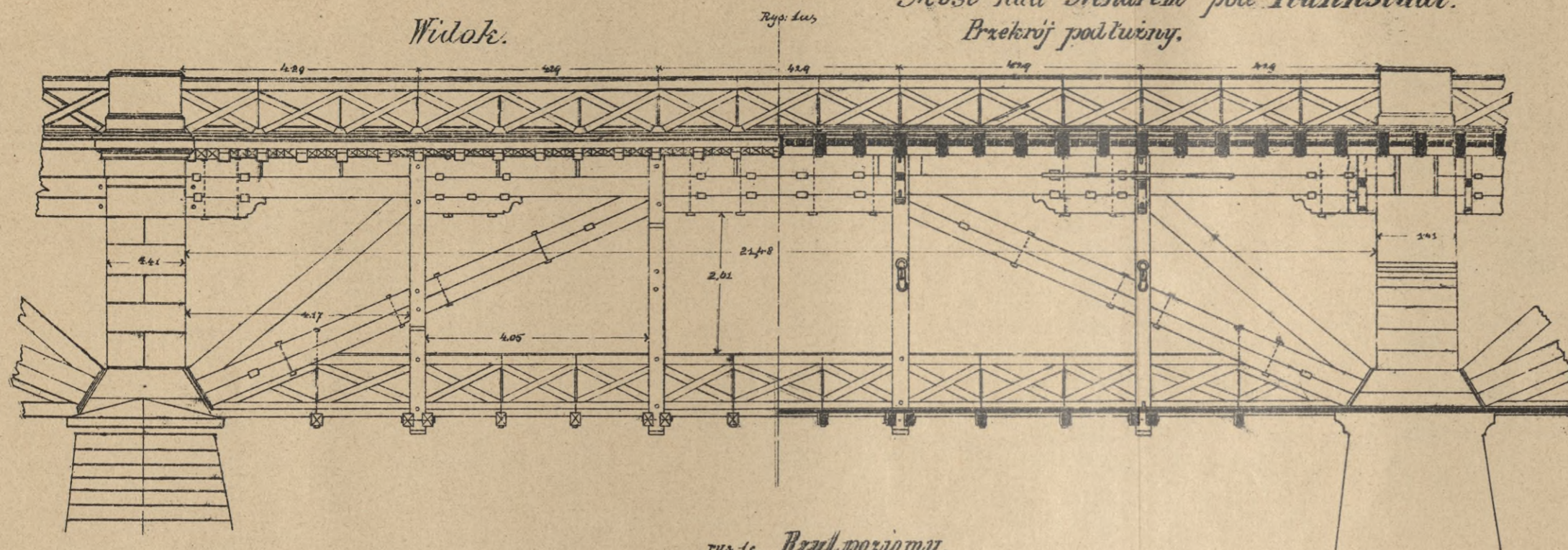

rys. 1c, Rzad poziomy.

rys. 1b, Przekrój poprzeczny.

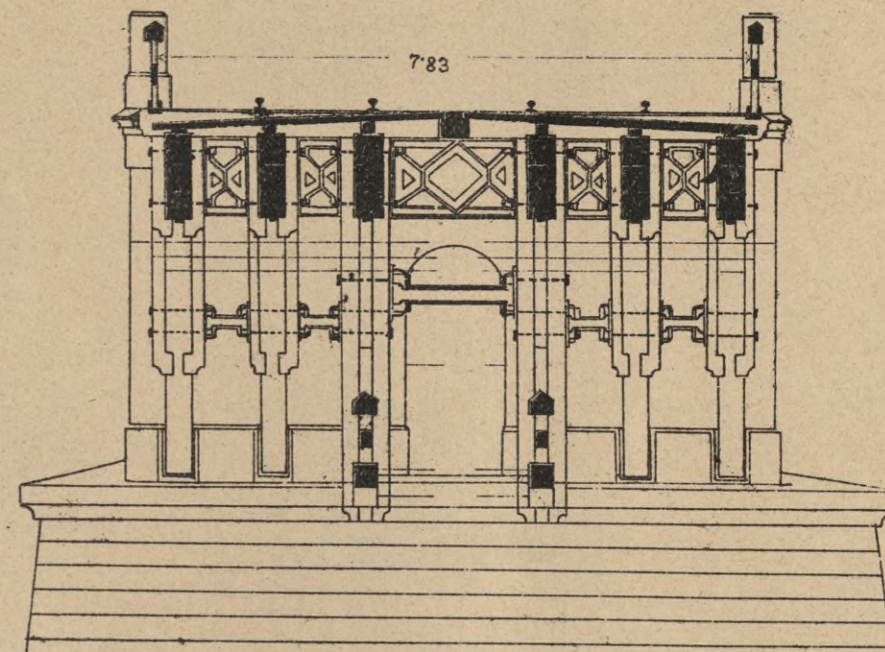

rys. 9.

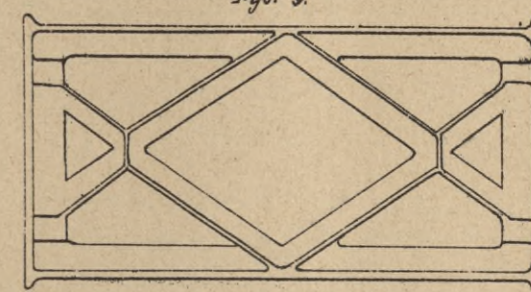

rys. 2, Szcegóły.

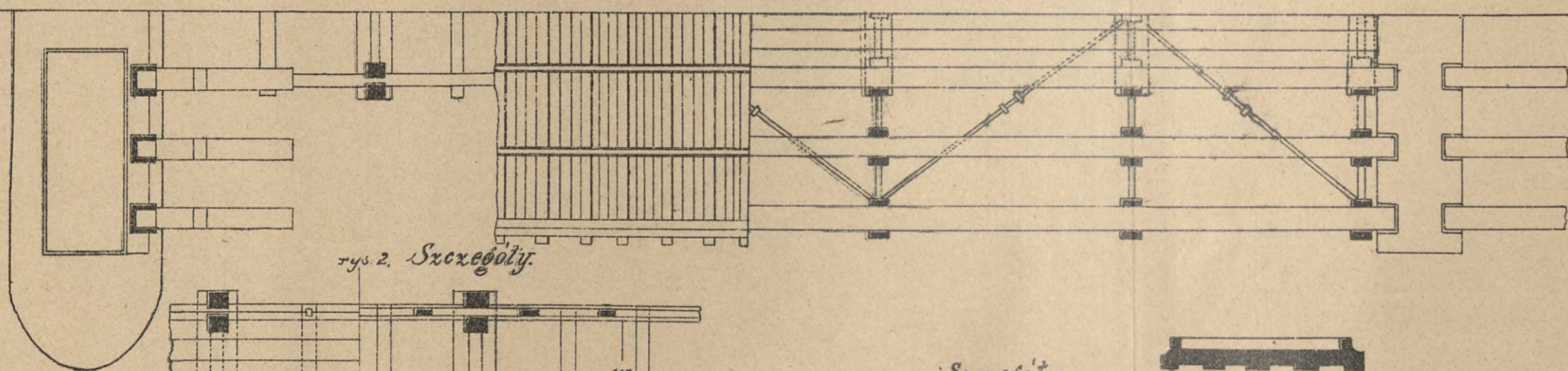

Szczegół

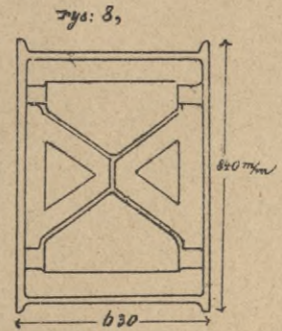
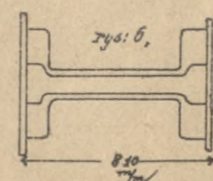
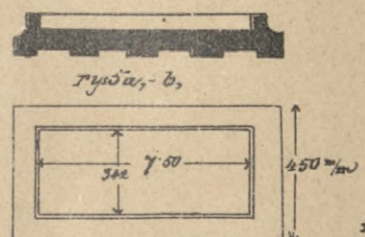
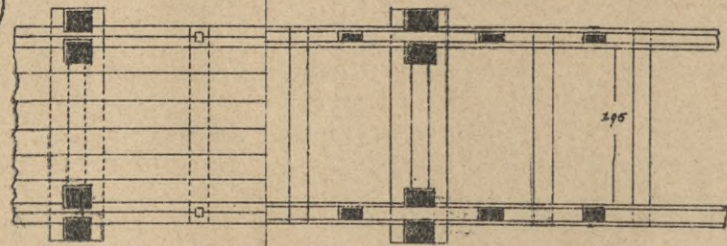

Szczegół

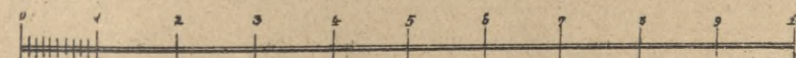
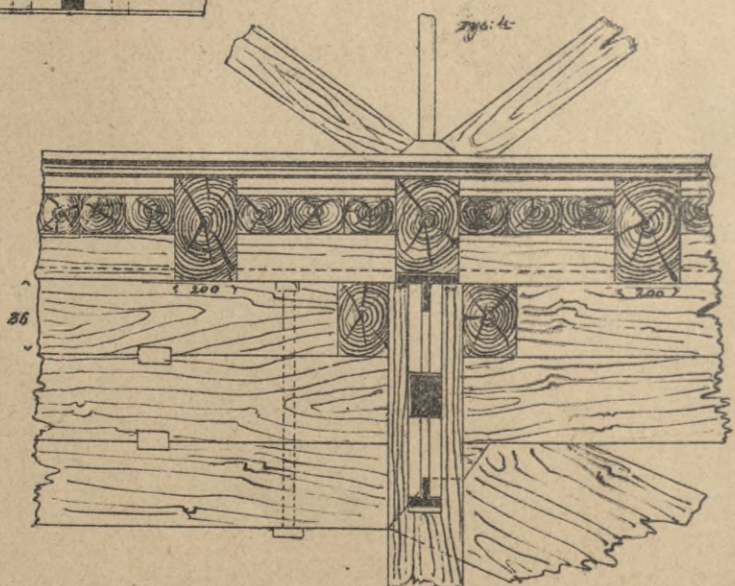
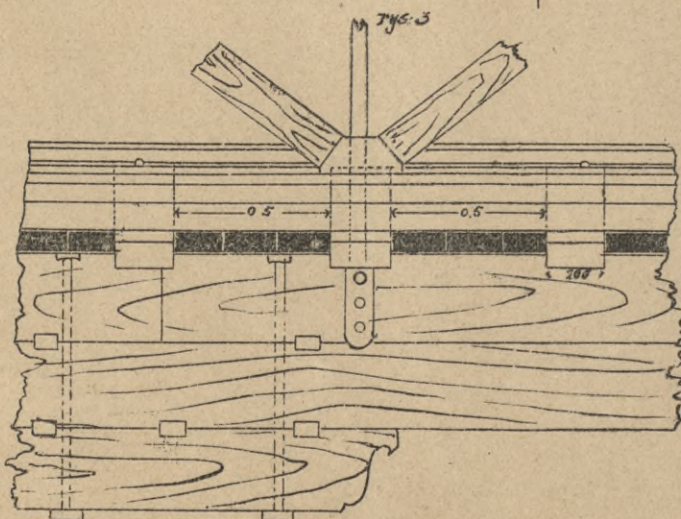
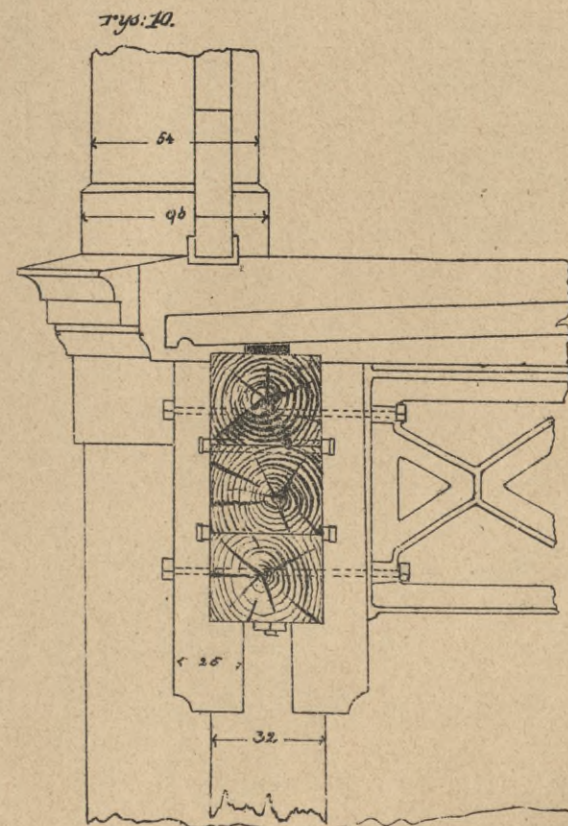

Skala 1:100
Szcegóły 1:35.

WIESZAR TRAPEZOWY.

Rys. 1a, Widok.

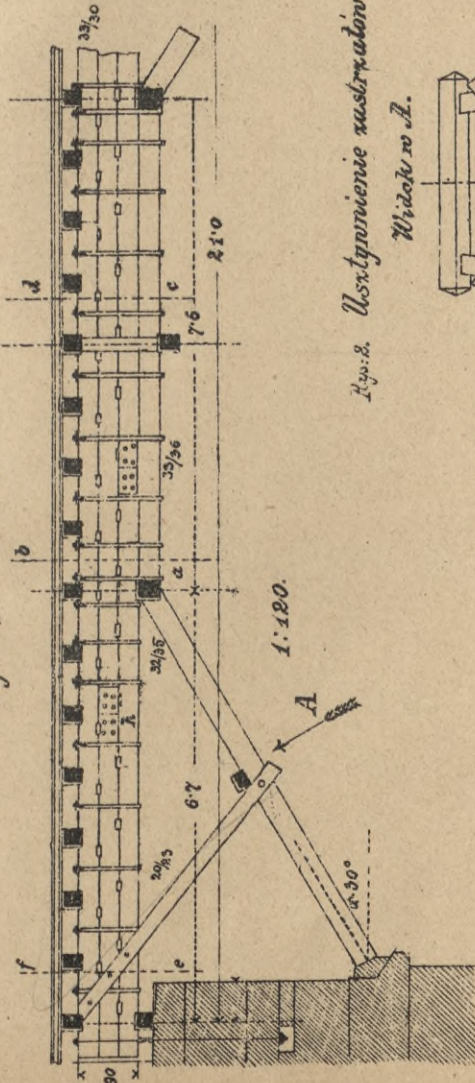

Rys. 1b, Szczytół.

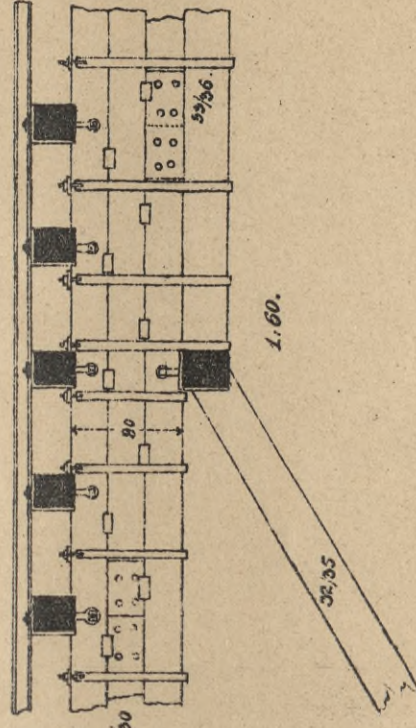

Rys. 2, Usztywnienie nastrojowników.

Widok w A.

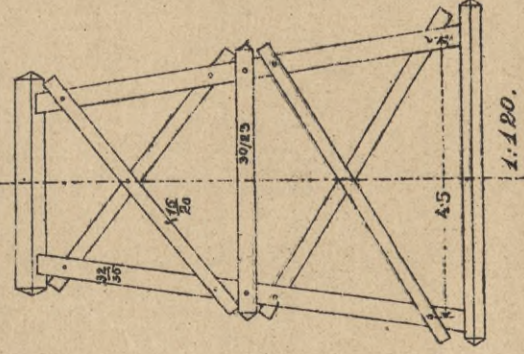

Przekroje poprzeczne.

1:120.

Rys. 3a, Przekroj.

a-b, c-d.

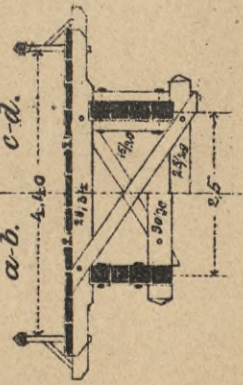

Rys. 3b, Przekroj e-f.

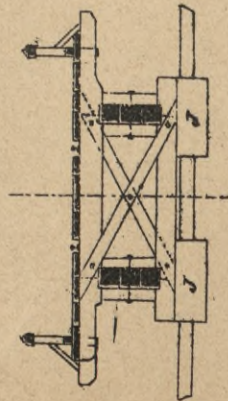

Skala 1:120

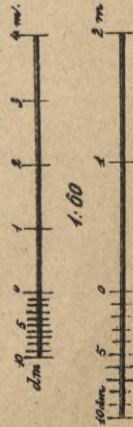

Szczytół.

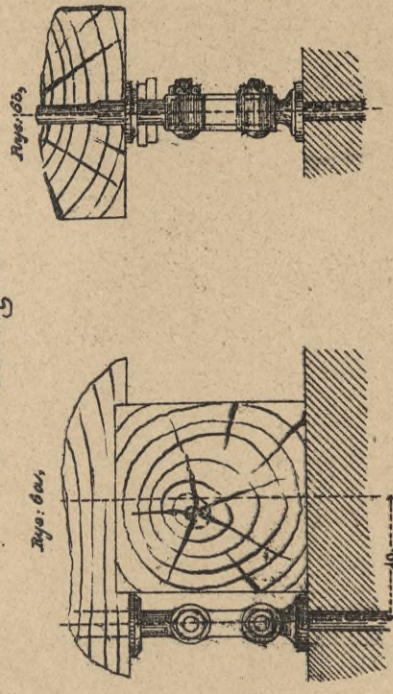

Szczytóły.

Rys. 5a,



1:40

Rys. 5b.

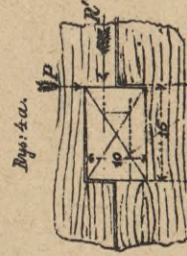
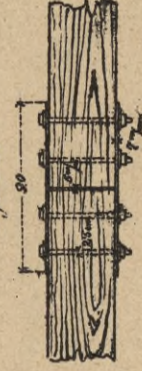

1:40.

Rys. 4b.



Skala 1:120,

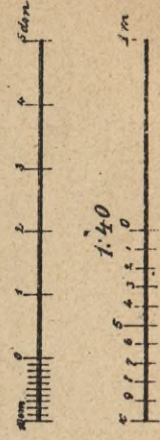

ROZPORNICE I WIESZARY.

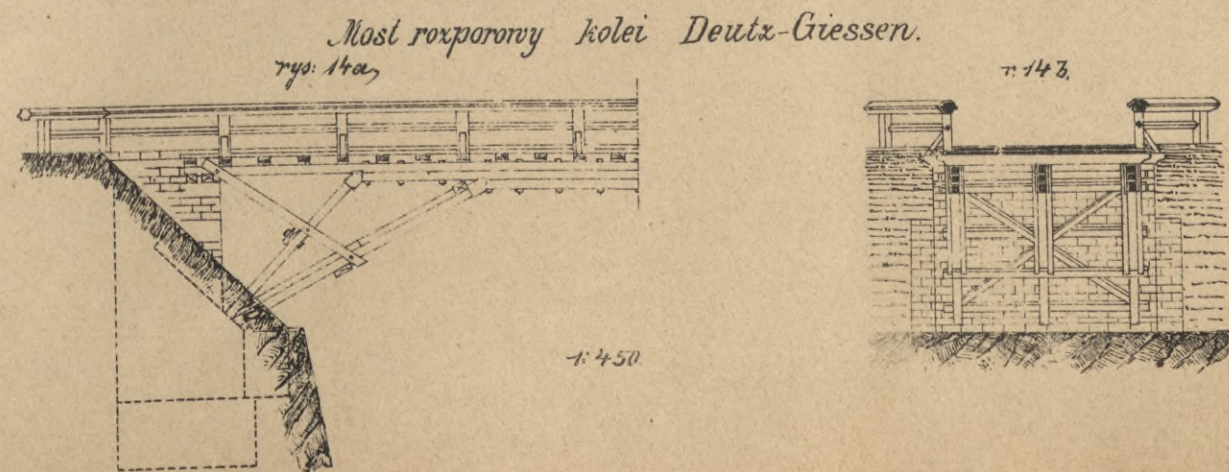
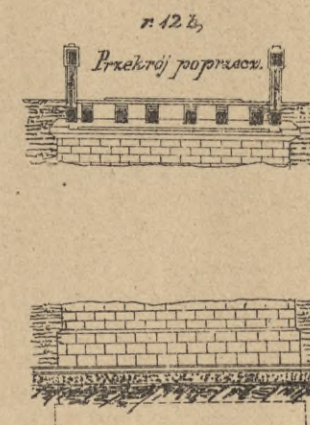
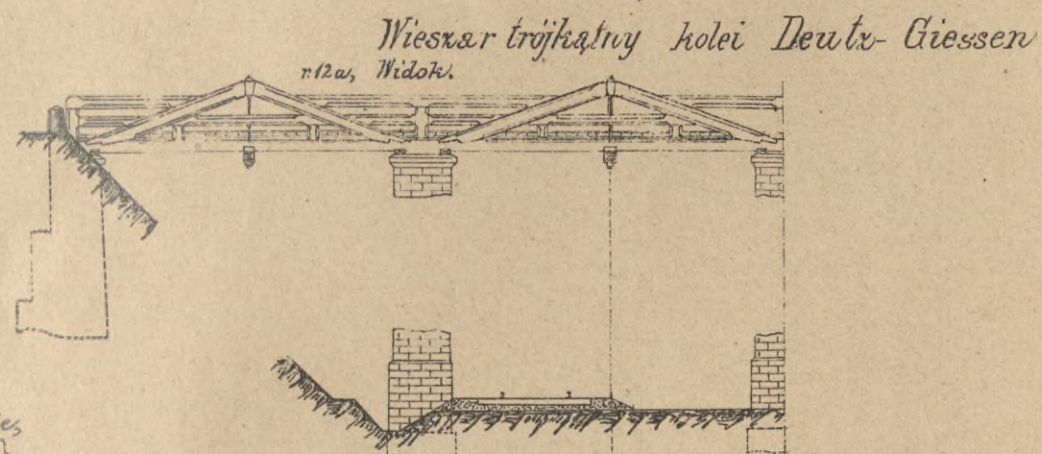
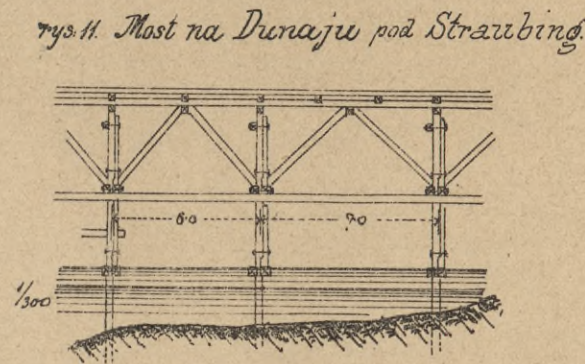
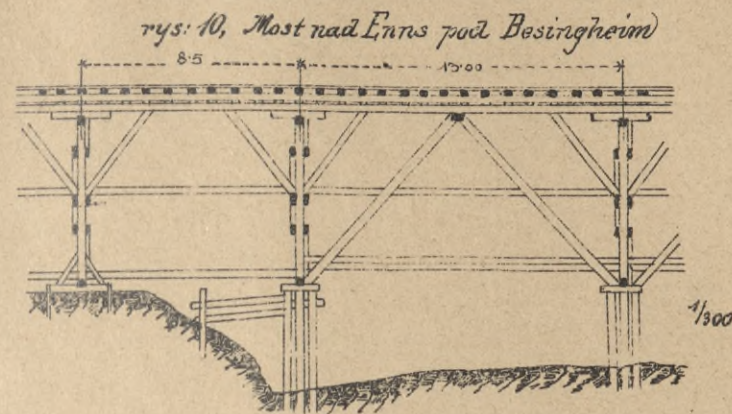
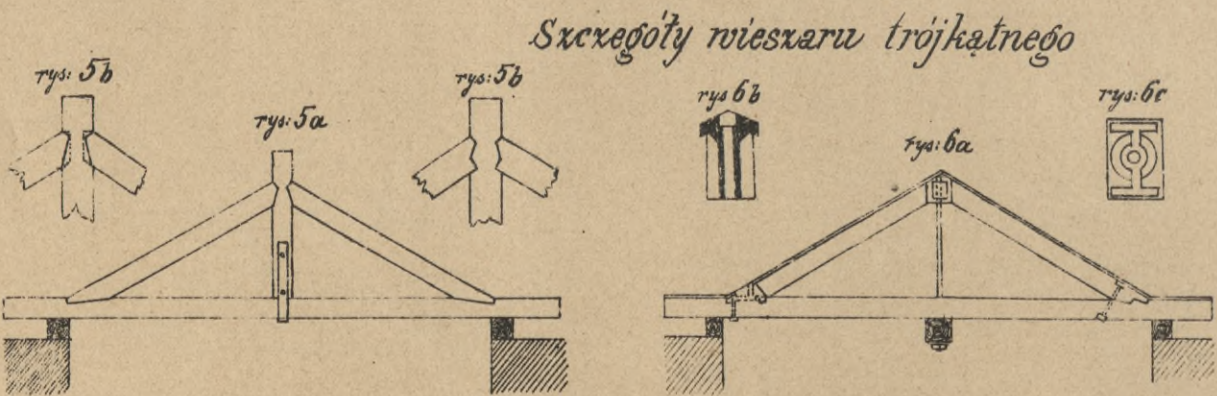
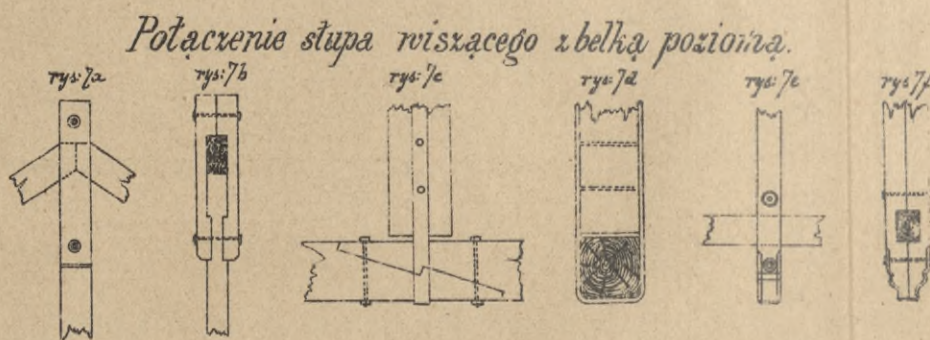
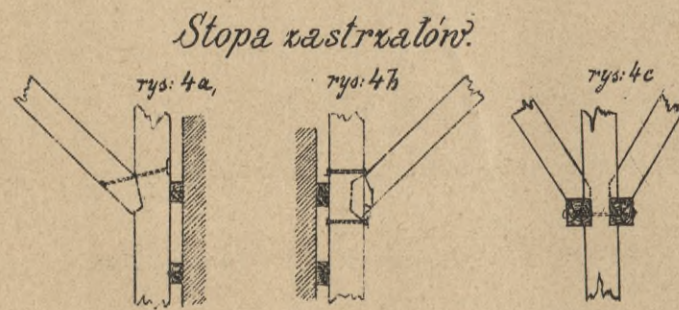
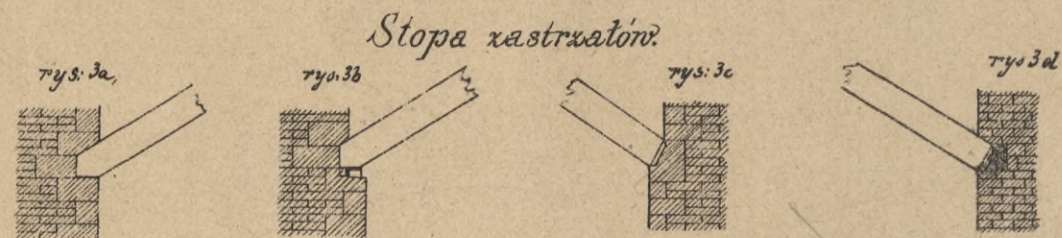
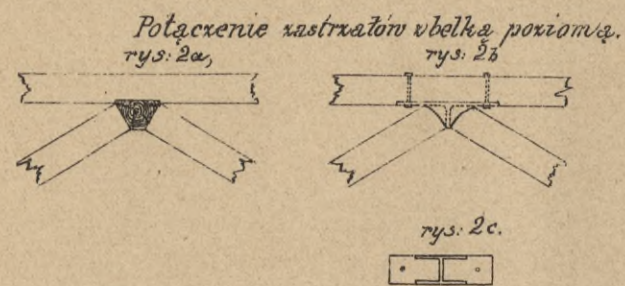
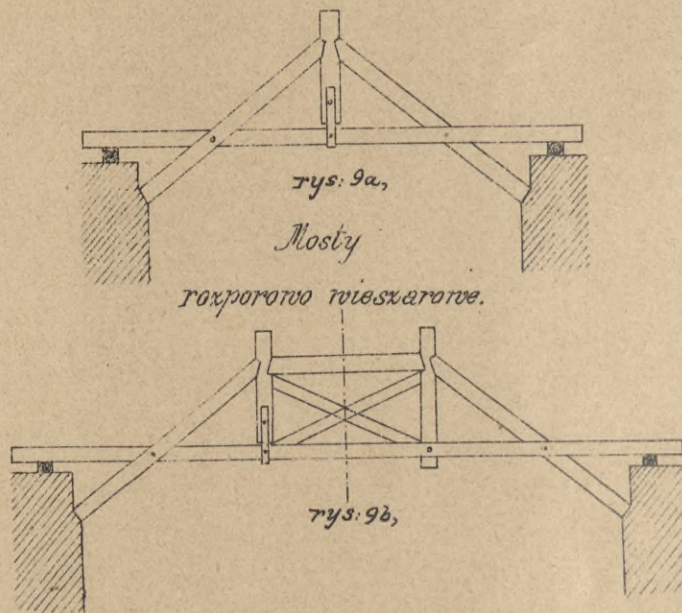

MOSTY ROZPOROWE

Most rozporowy niemiecki.

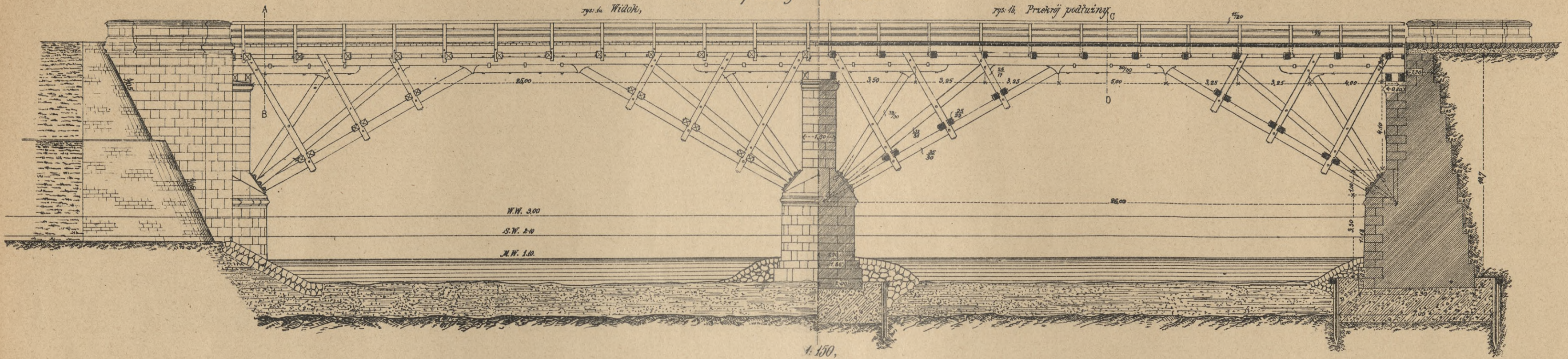

Głowa kastraton

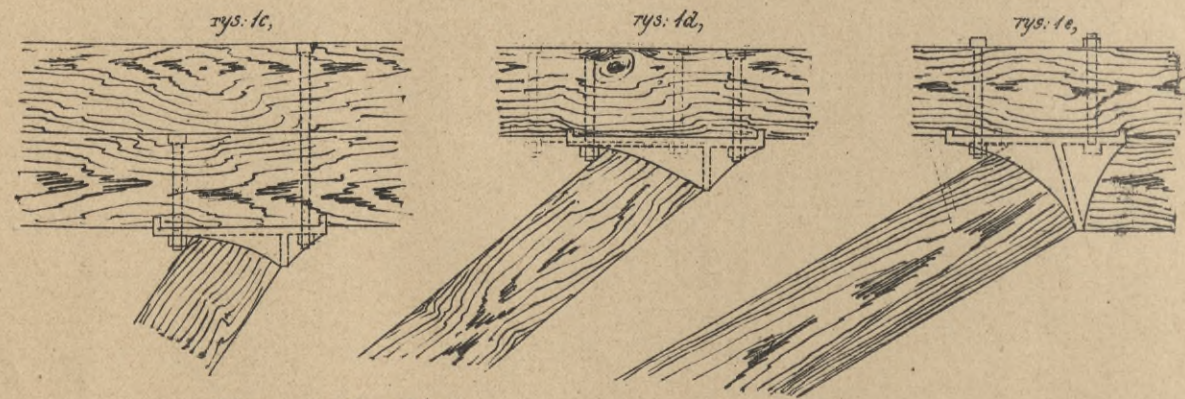

Stopa kastraton

1:25,

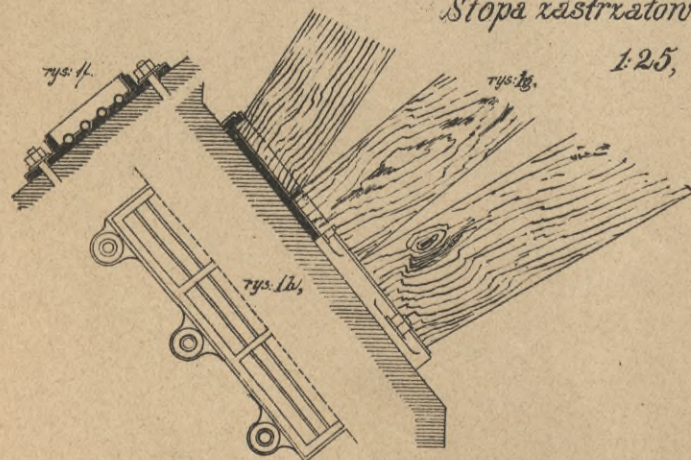

Most tymczasowy na Neckarze. (Rozporowica wieloboczna)

rys. 2a, Widok

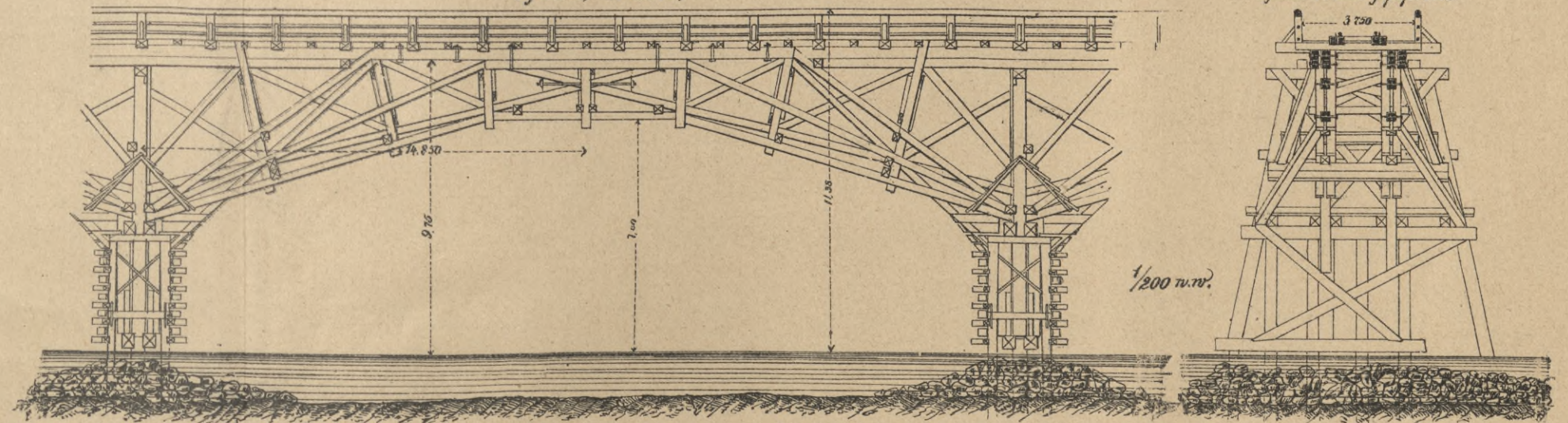

rys. 2b Przekroj poprzeczny

1/200 n.v.

MOST NA SANIE W PRZEMYŚLU ZBUD. W R. 1779; ZBURZ. PRZEZ W. WODĘ W R. 1845.

Widok 3^{ty} przęsła
Fig. 1a,

Przekrój 4^{ty} przęsła
Fig. 1b

Portal
Fig. 2,

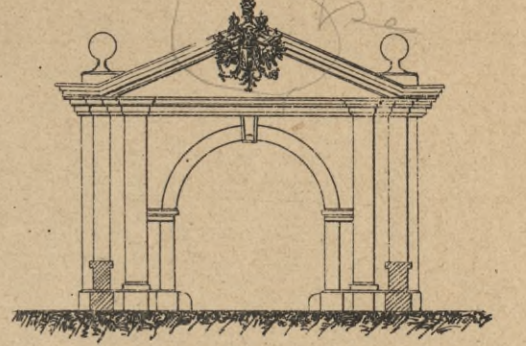
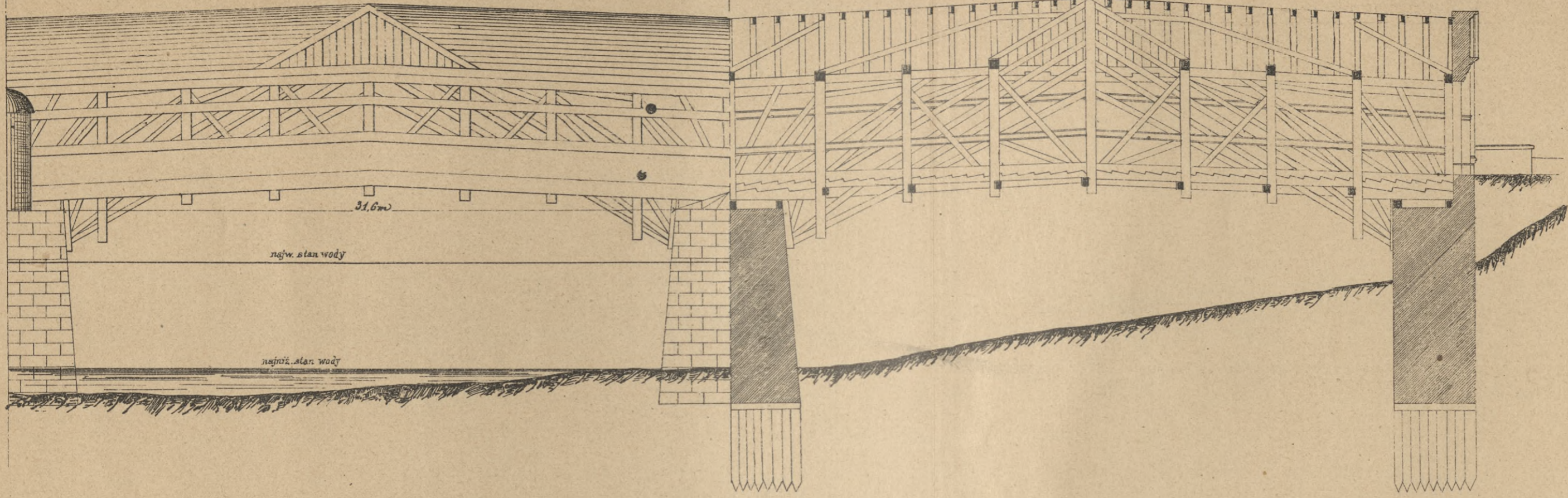

Przekrój A-B,
Fig. 3a,

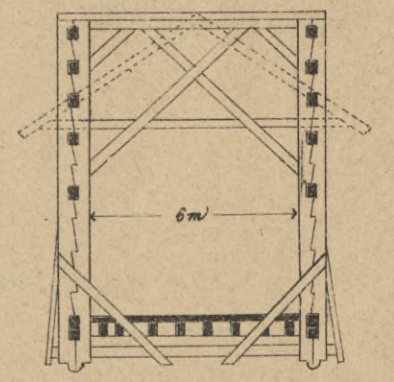

Rys. 4a-b, Rzut poziomy.

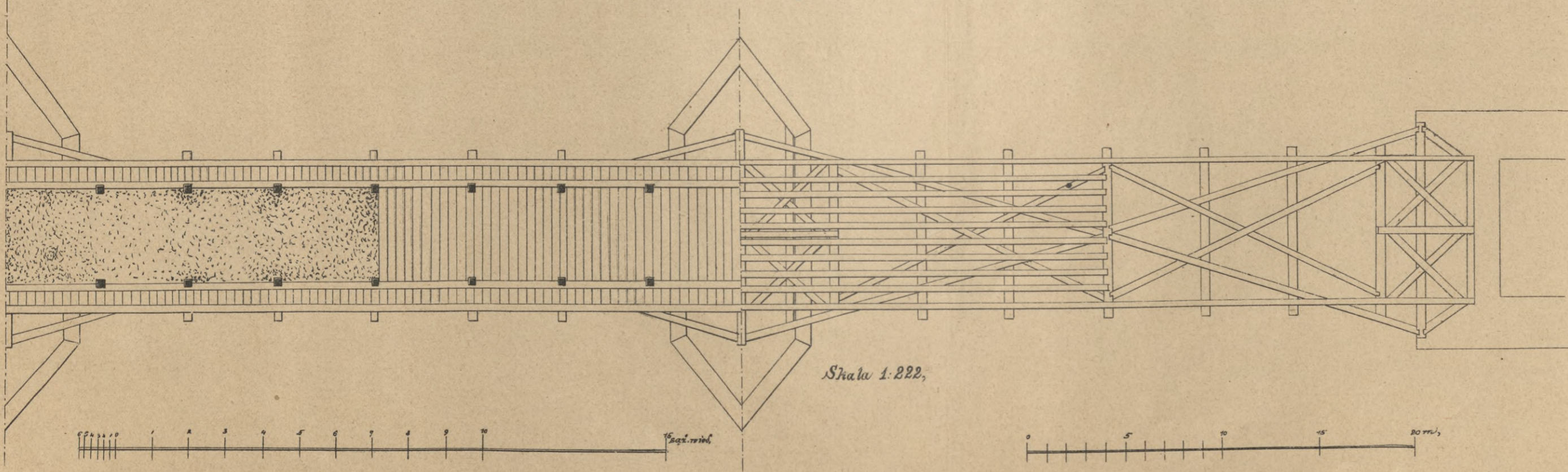

Rys. 3b, Przekrój C-D.

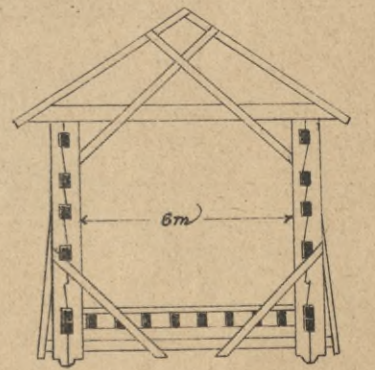

OBLICZENIE ROZPORNICY TRAPEZOWEJ

rys. 1a.

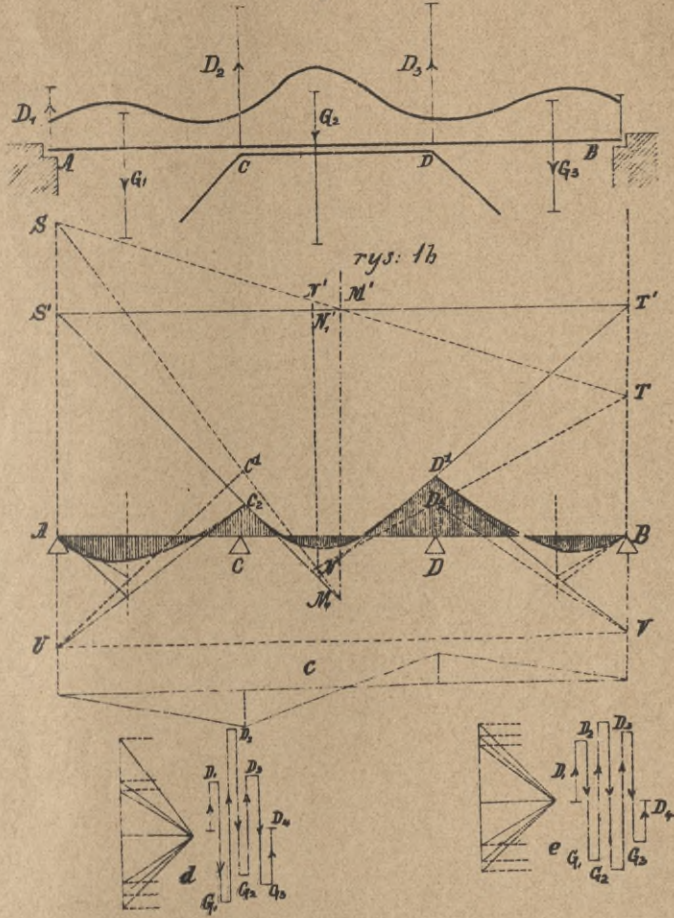

rys. 1b

rys. 3a.

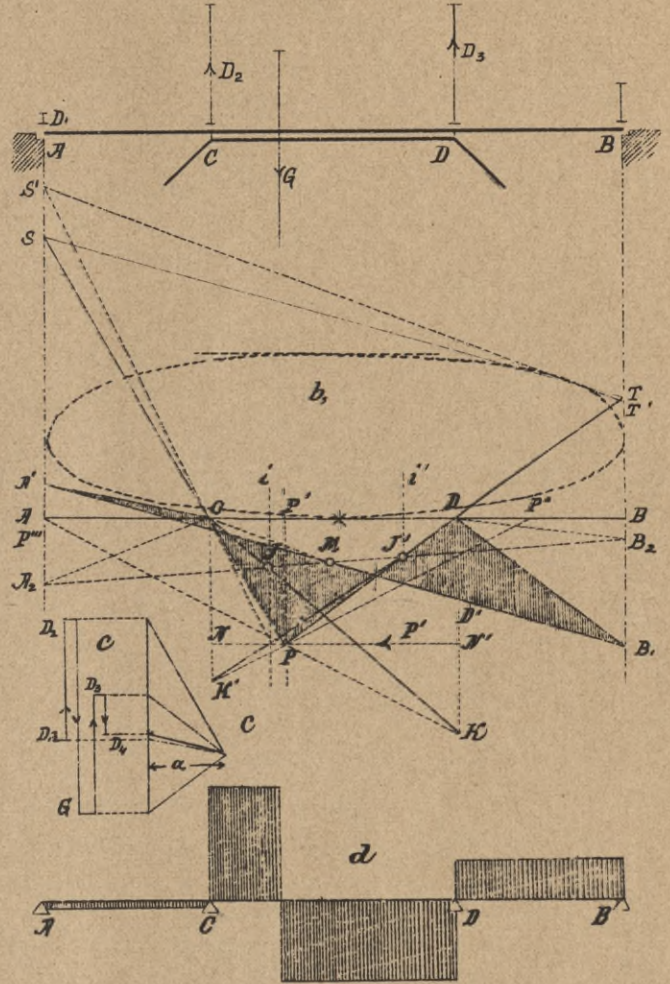

rys. 2a.

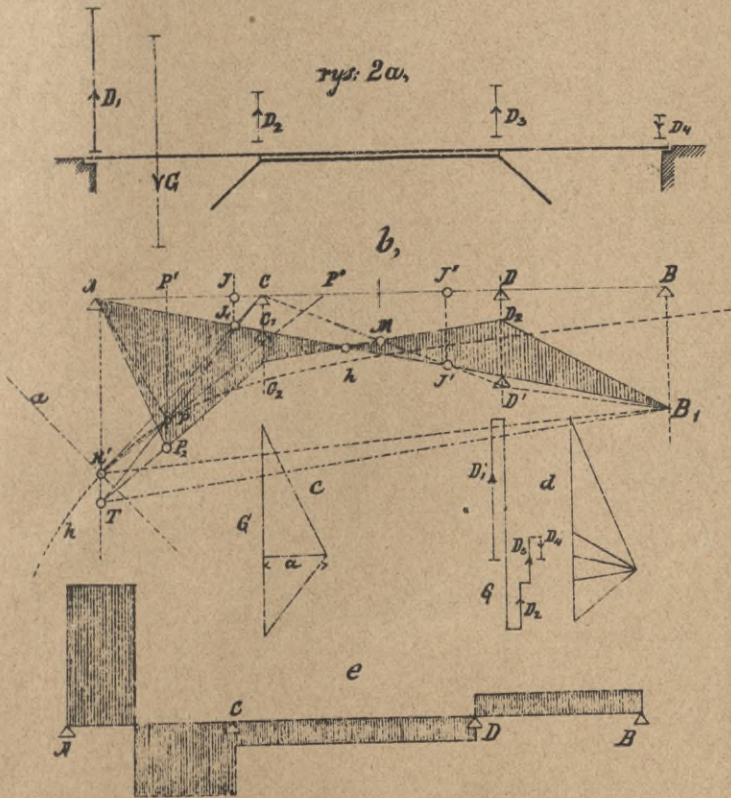

rys. 4a.

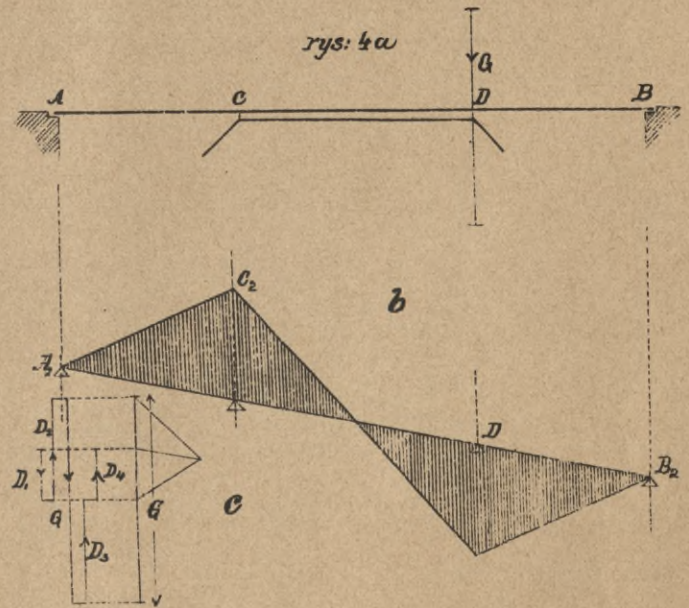

rys. K.

OBLICZENIE WYKRĘSLNE ROZPORNIC.

Rys. 2.

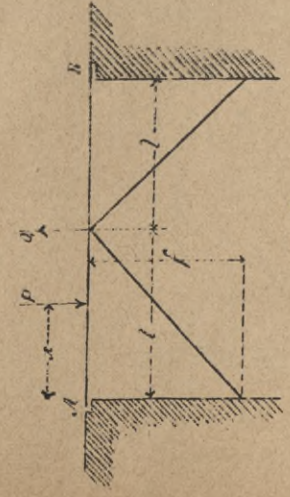

Rys. 1.
Rozporna trójkatna.

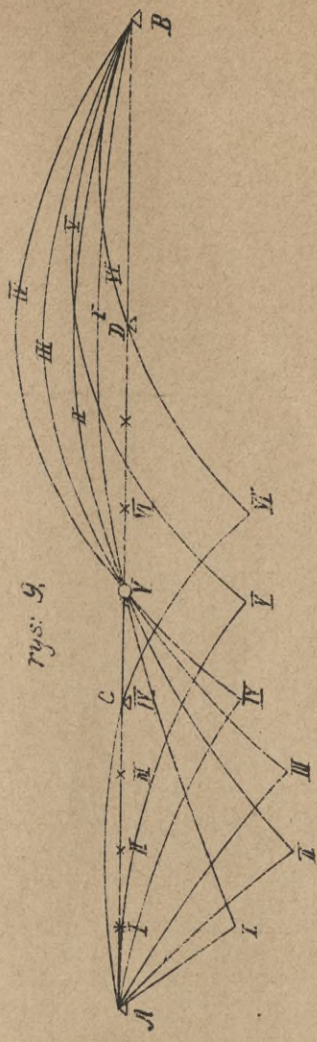
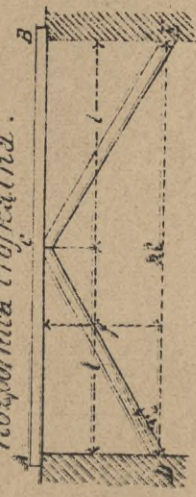

Rys. 9.

Rys. 3.

Linia rozpornowa dla D.

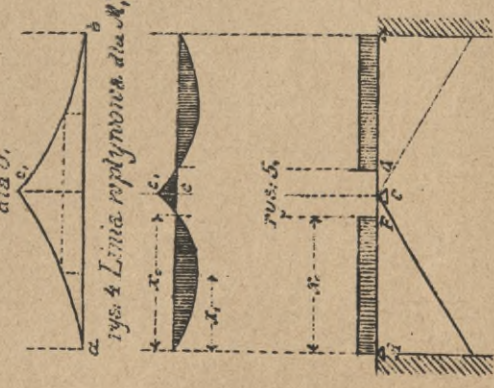

Rys. 4

Linia rozpornowa dla M.

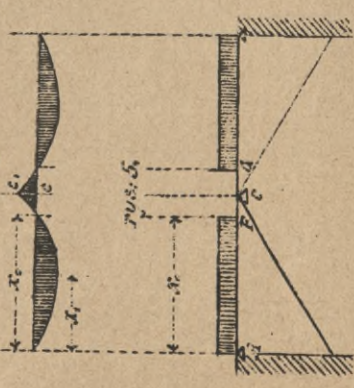

Rys. 6.

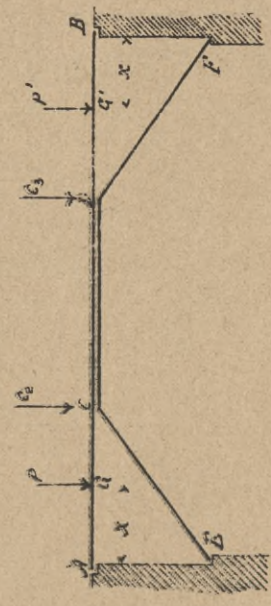

Rys. 10.

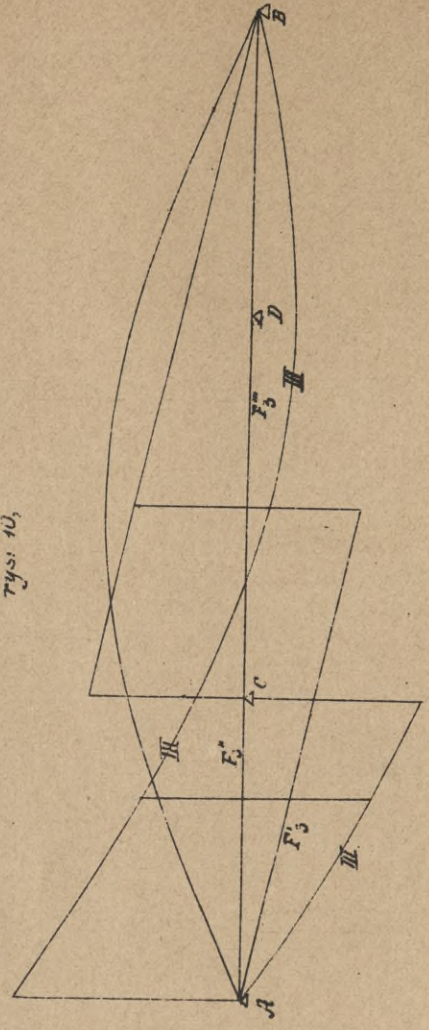

Rys. 8.

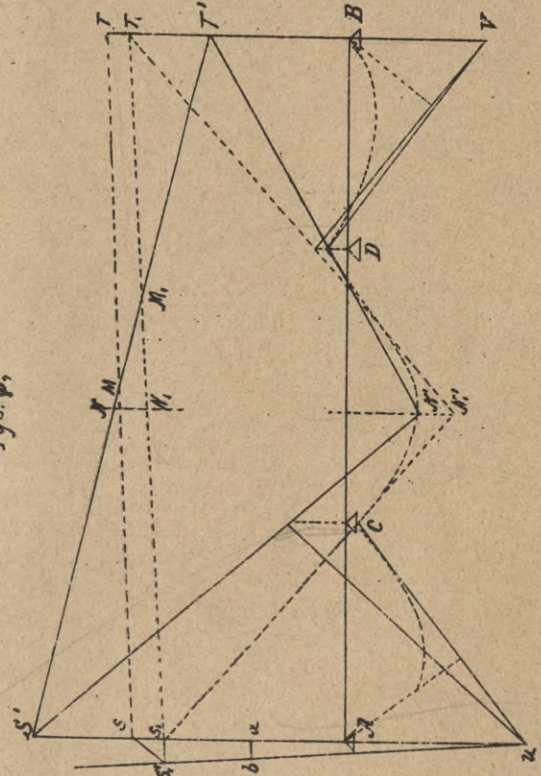

Rys. 11.

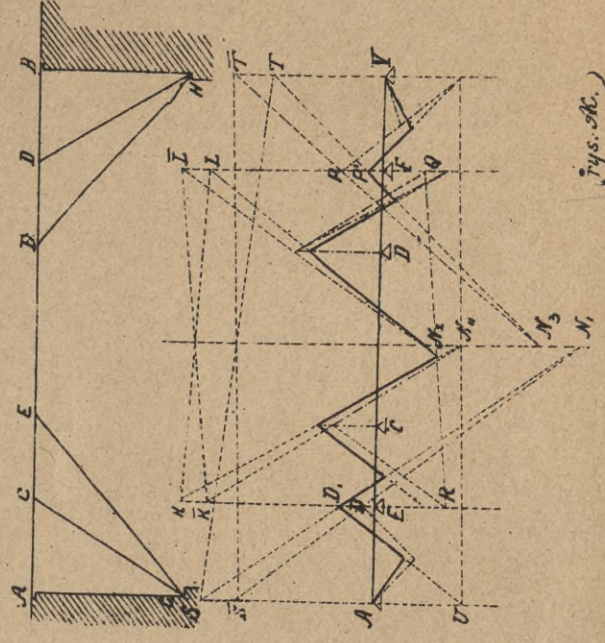

Rys. 12.

Most na Innie pod Stulstein.

rys. 1.a.

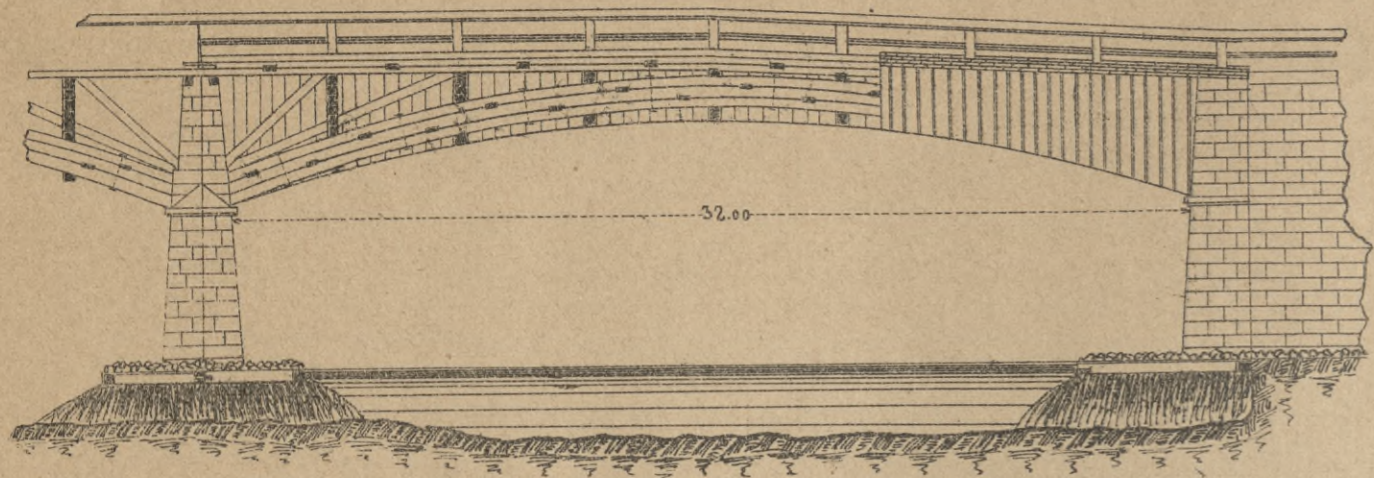

rys. 1.b.

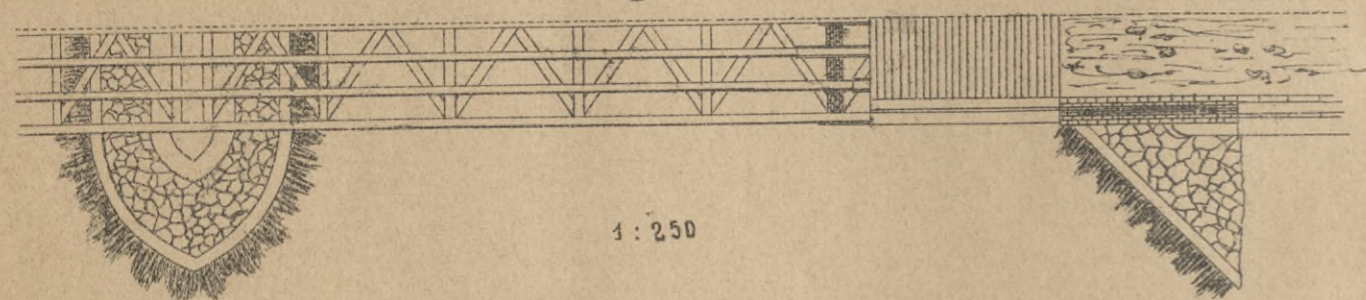

Most łukowy giętki.

rys. 3.

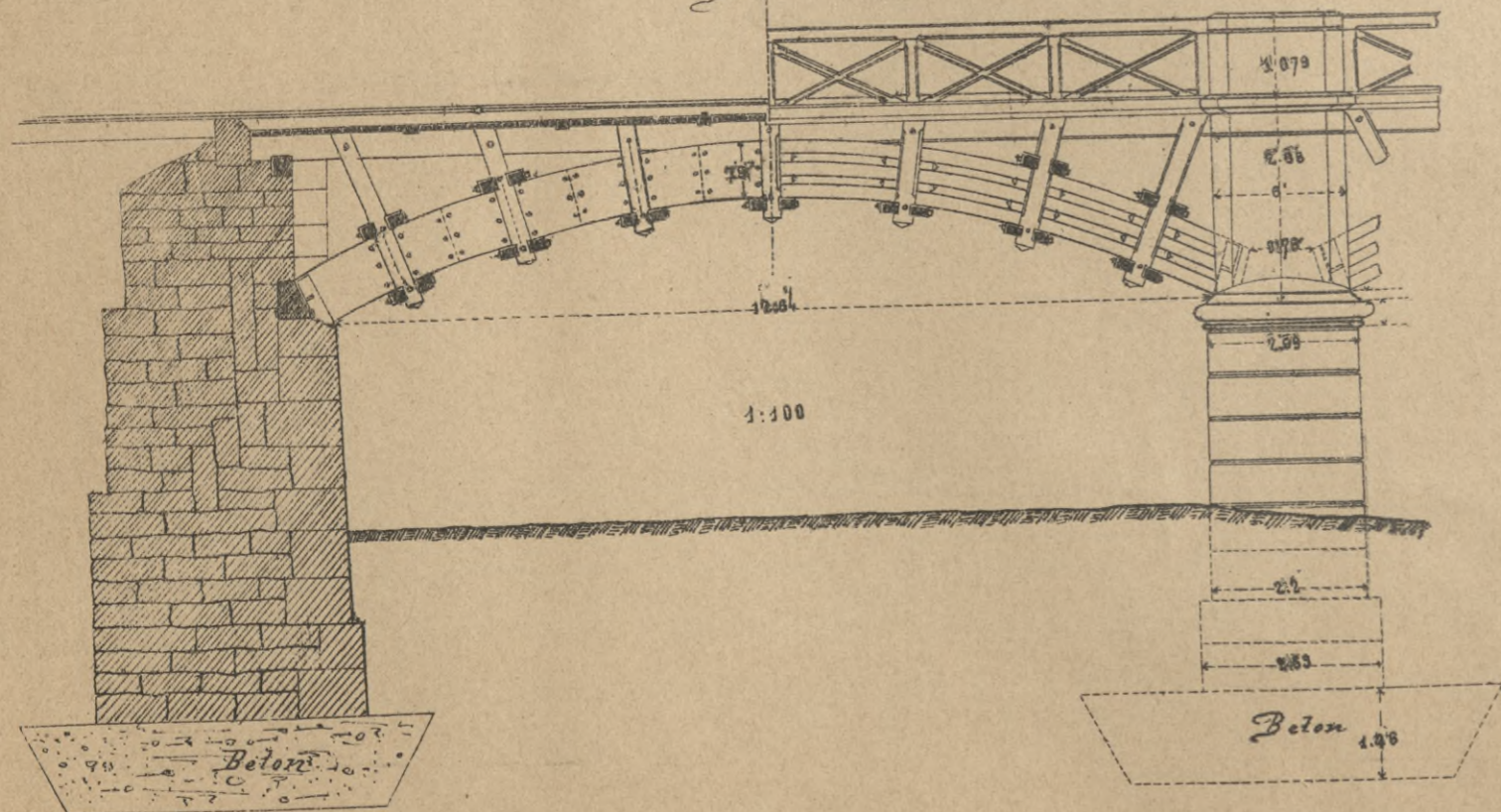

Thullie Mosty drewniane II.

MOSTY ŁUKOWE.

Most wodospadowy.

rys. 2.

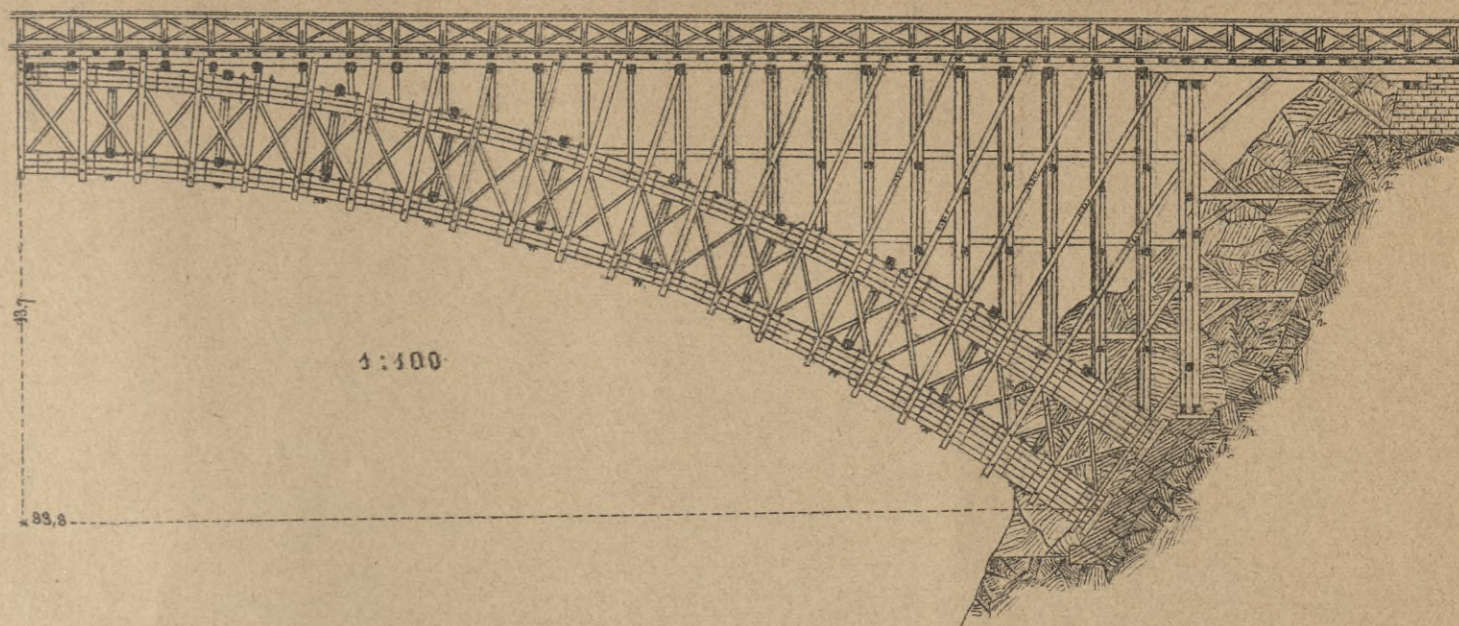

rys. 4.

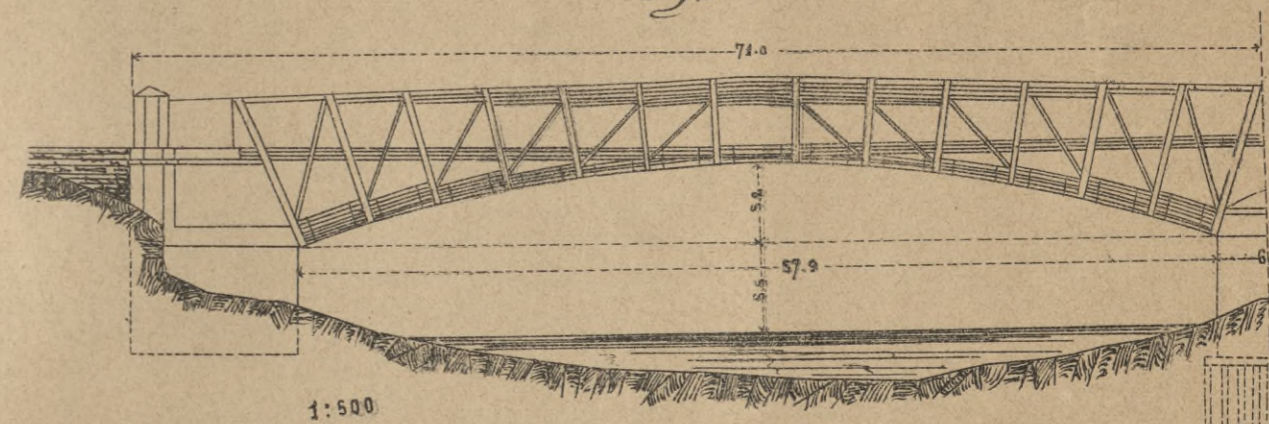

rys. 5.

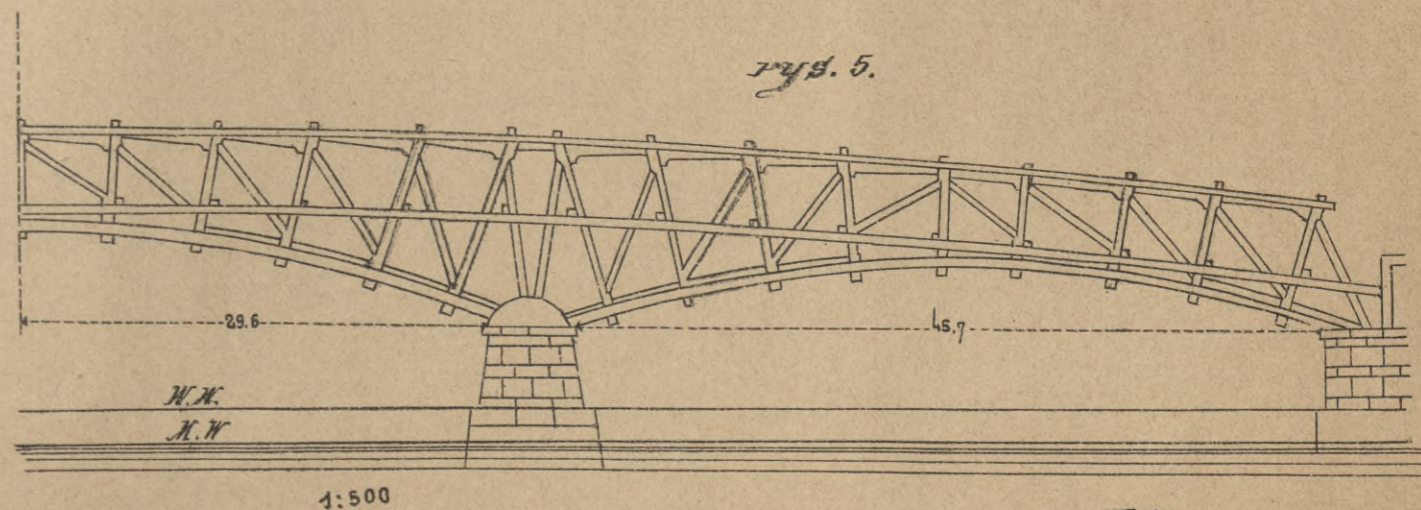

rys. P.II.

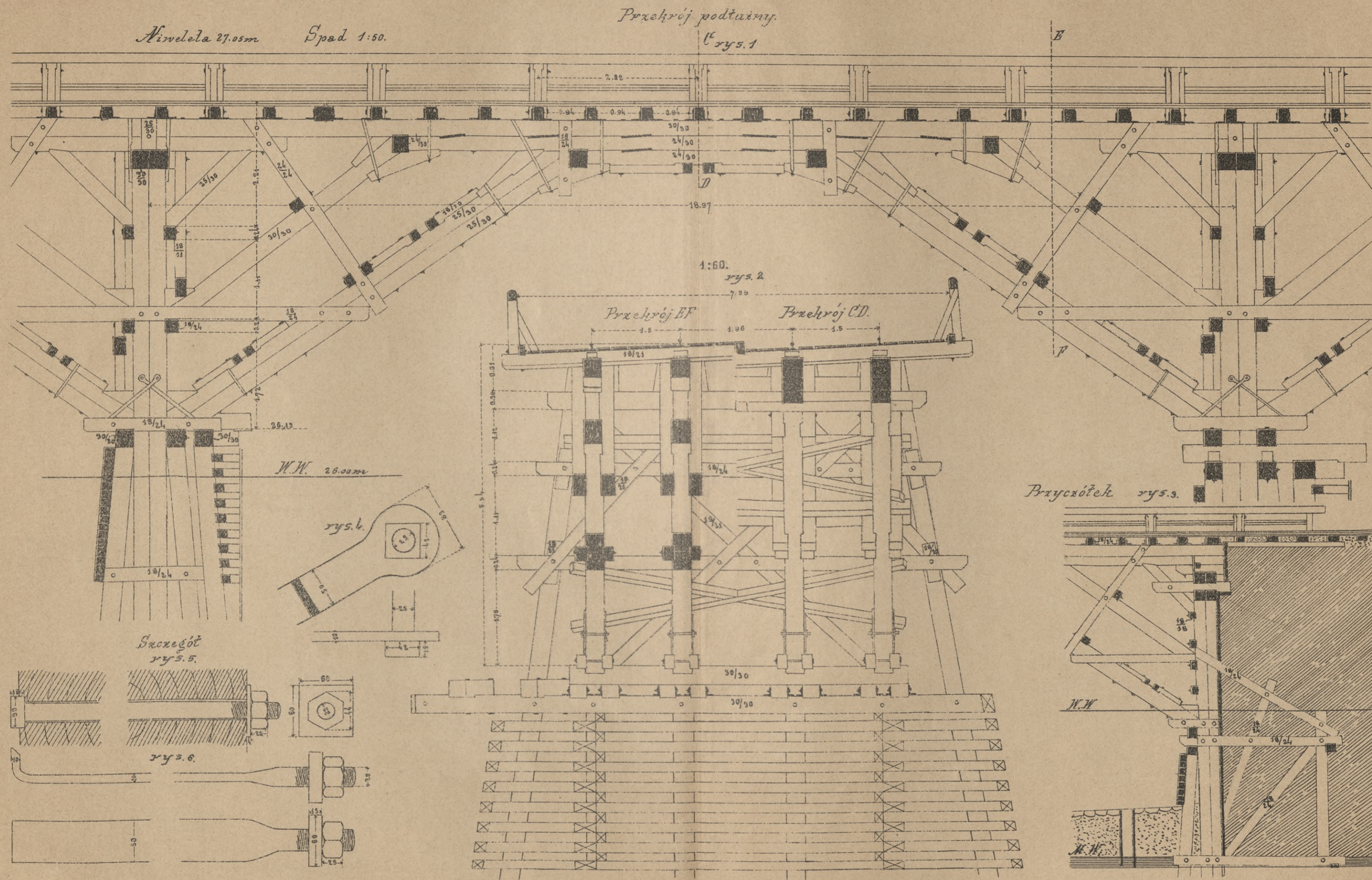

Most stalny żelazny o rozp. 20m

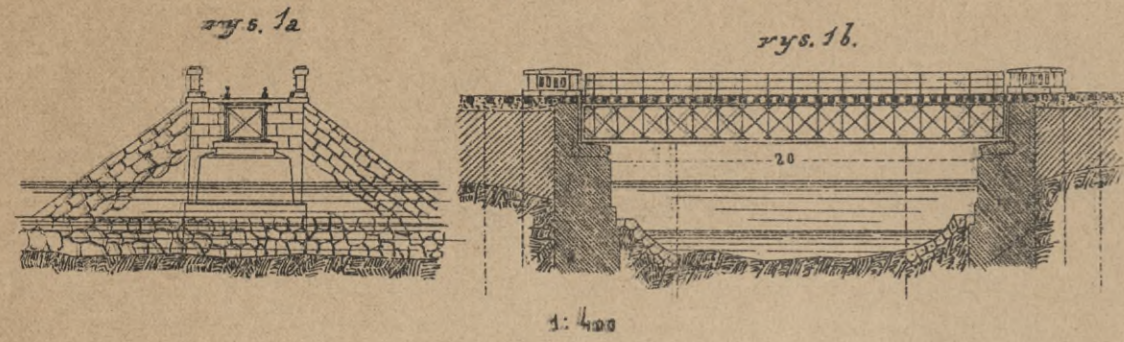

Most tymczasowy drewniany

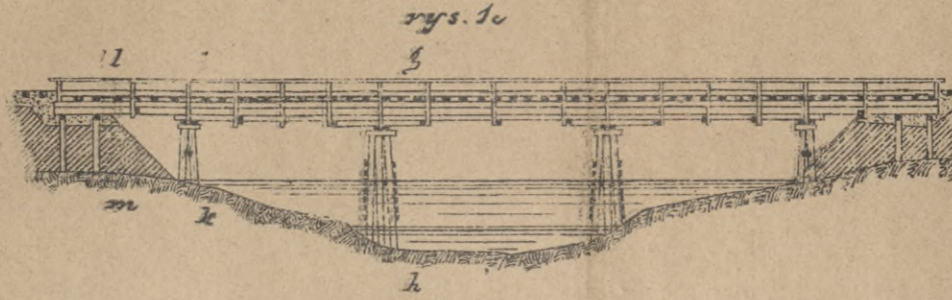

Przekroje

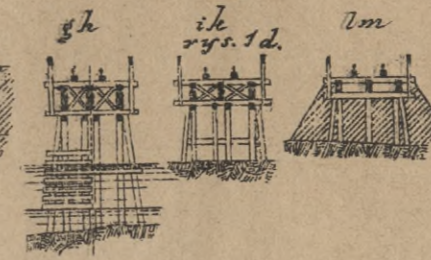

Most tymczasowy podczas budowy porzepondu.

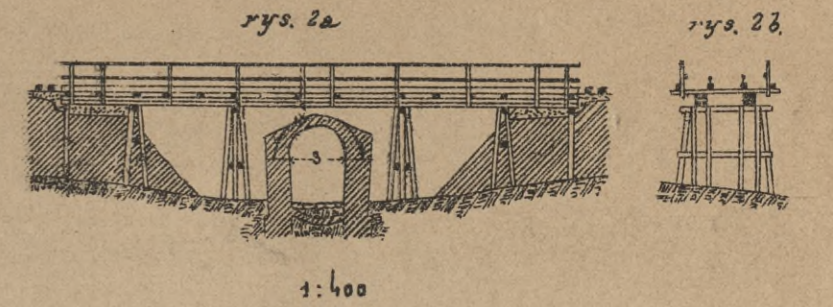

Most wojenny na Moseli w Pont-a-Mousson.

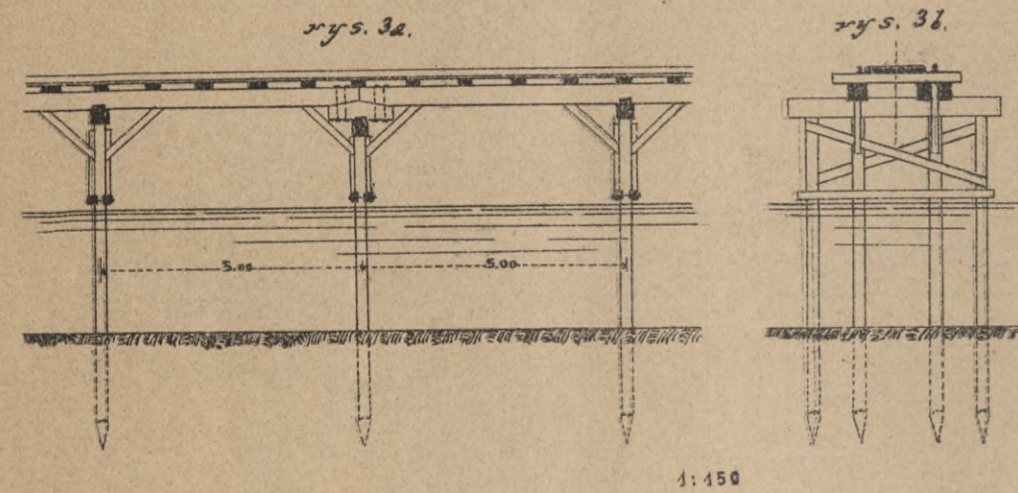

Most tymczasowy drogowy.

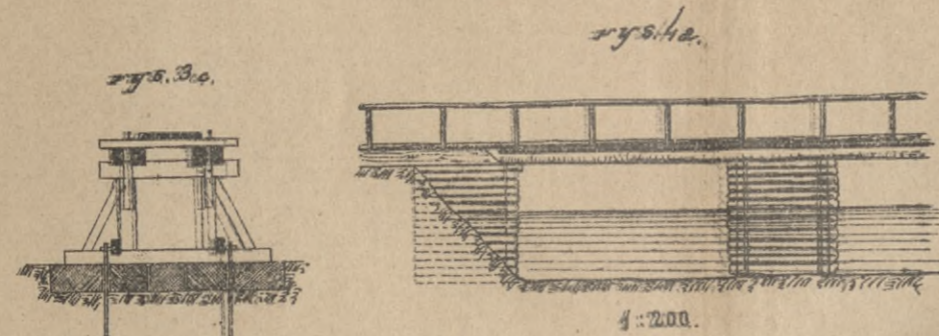

Most tymczasowy na Marnie pod Fontaines

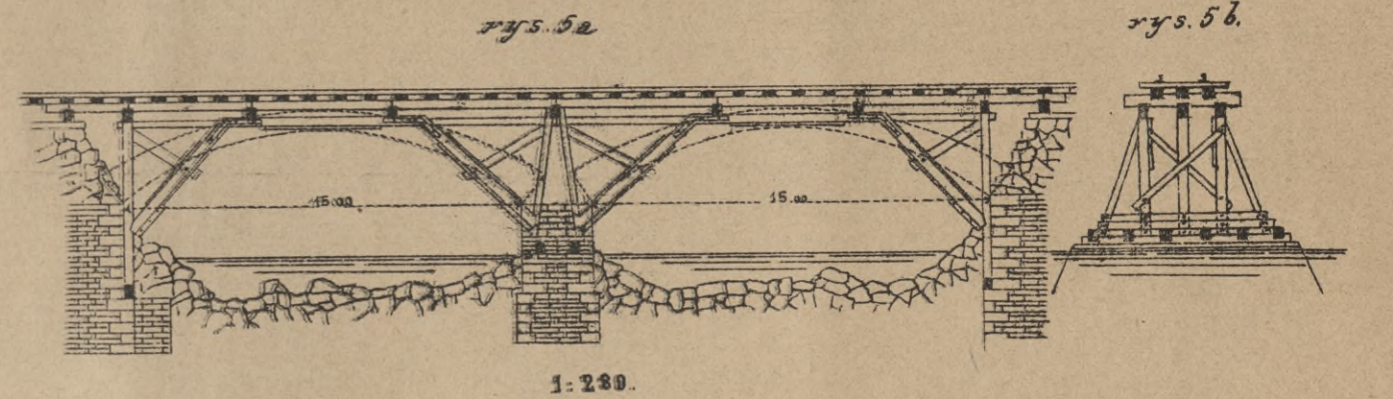

Most tymczasowy na Marnie pod Villiers.

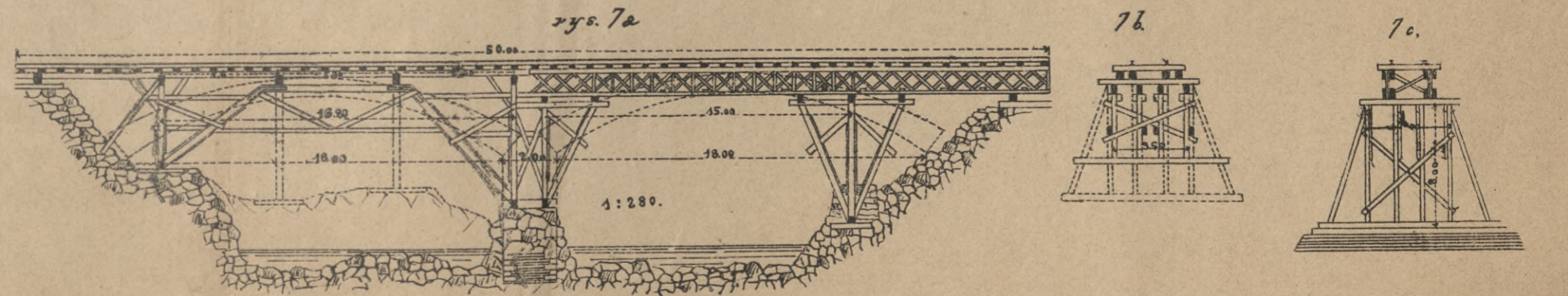

Most krakowscy wojenny.

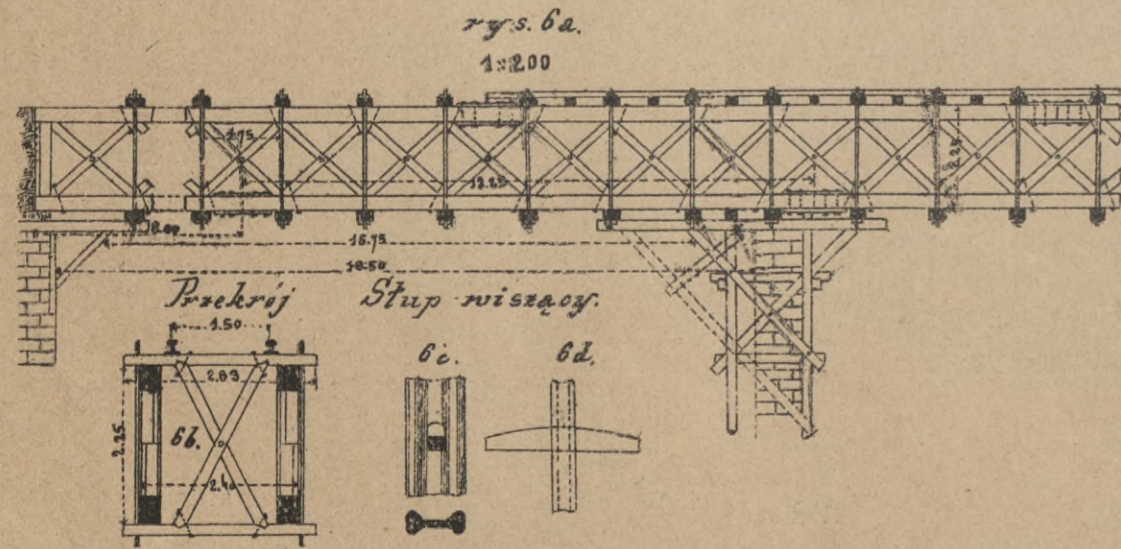

BIBLIOTEKA POLITECHNICZNA KRAKÓW

5. 61

Biblioteka Politechniki Krakowskiej



10000249940

2

Biblioteka Politechniki Krakowskiej



IV-300753

Biblioteka Politechniki Krakowskiej



10000249940