

DER ZIMMERERMEISTER

VON

PROF. ANDREAS BAUDOIN WIEN

ZWEITE ERGÄNZTE UND VERBESSERTE AUFLAGE

I. TEIL

ELEMENTE IM ZIMMERERMEISTERGEWERBE

ALLGEMEINE KONSTRUKTIONEN IM ZIMMERERMEISTERGEWERBE

WIEN 1926



VERLAG VON JULIUS SPRINGER
BIBLIOTEKA CYFROWA POLITECHNIKI KRAKOWSKIEJ

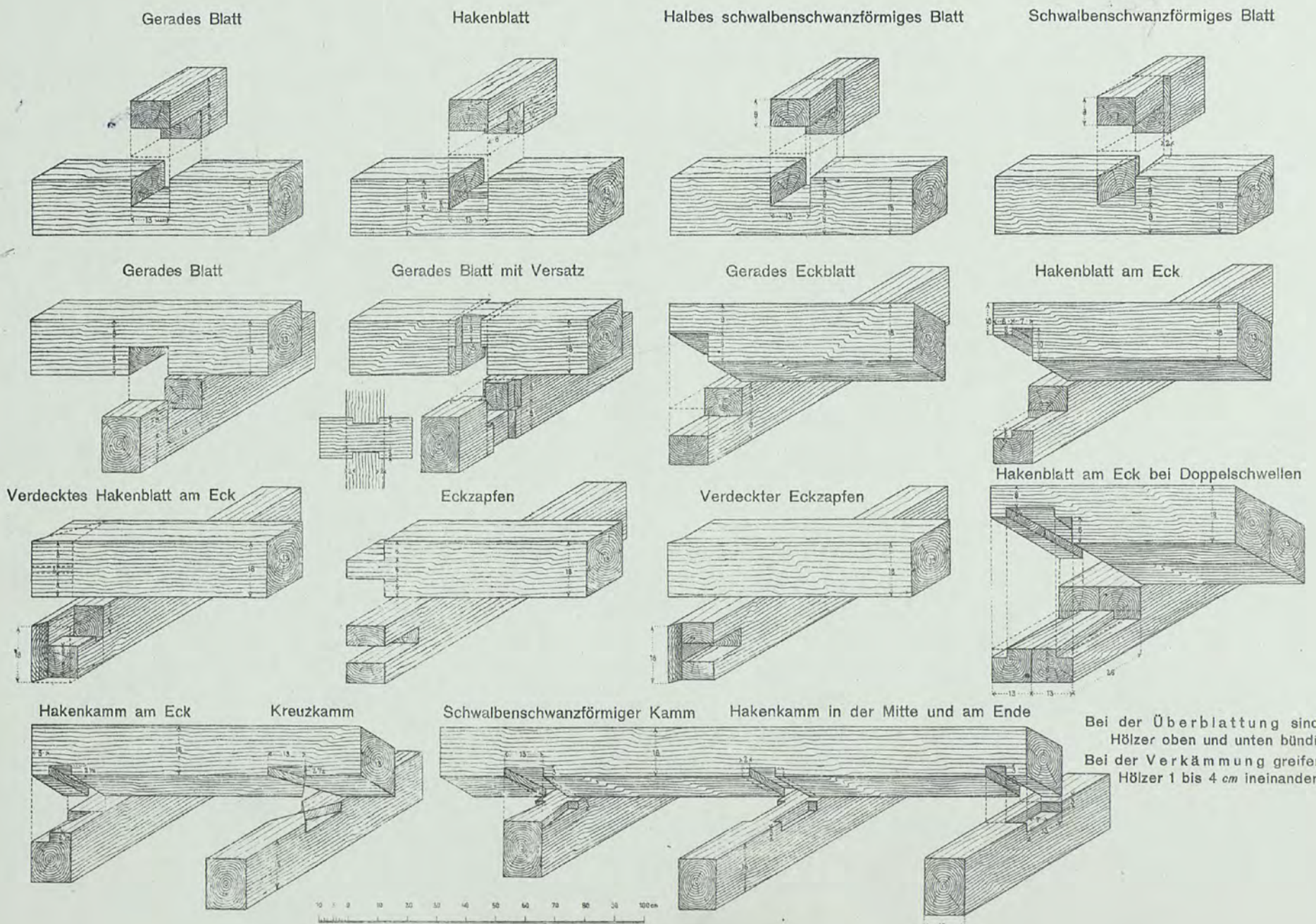
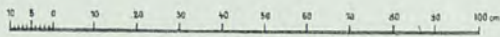
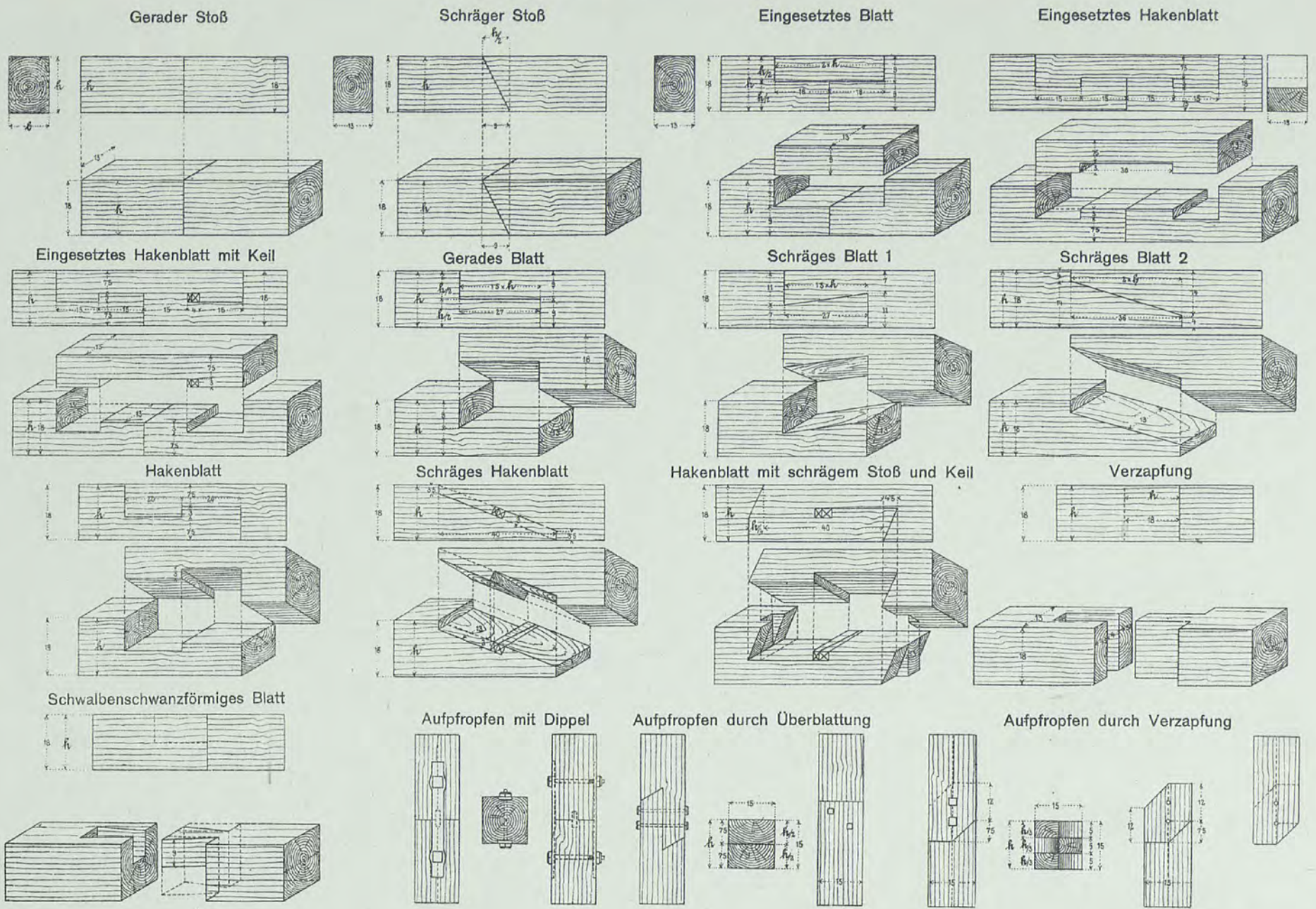

Bei der Überblattung sind die Hölzer oben und unten bündig
Bei der Verkämmung greifen die Hölzer 1 bis 4 cm ineinander

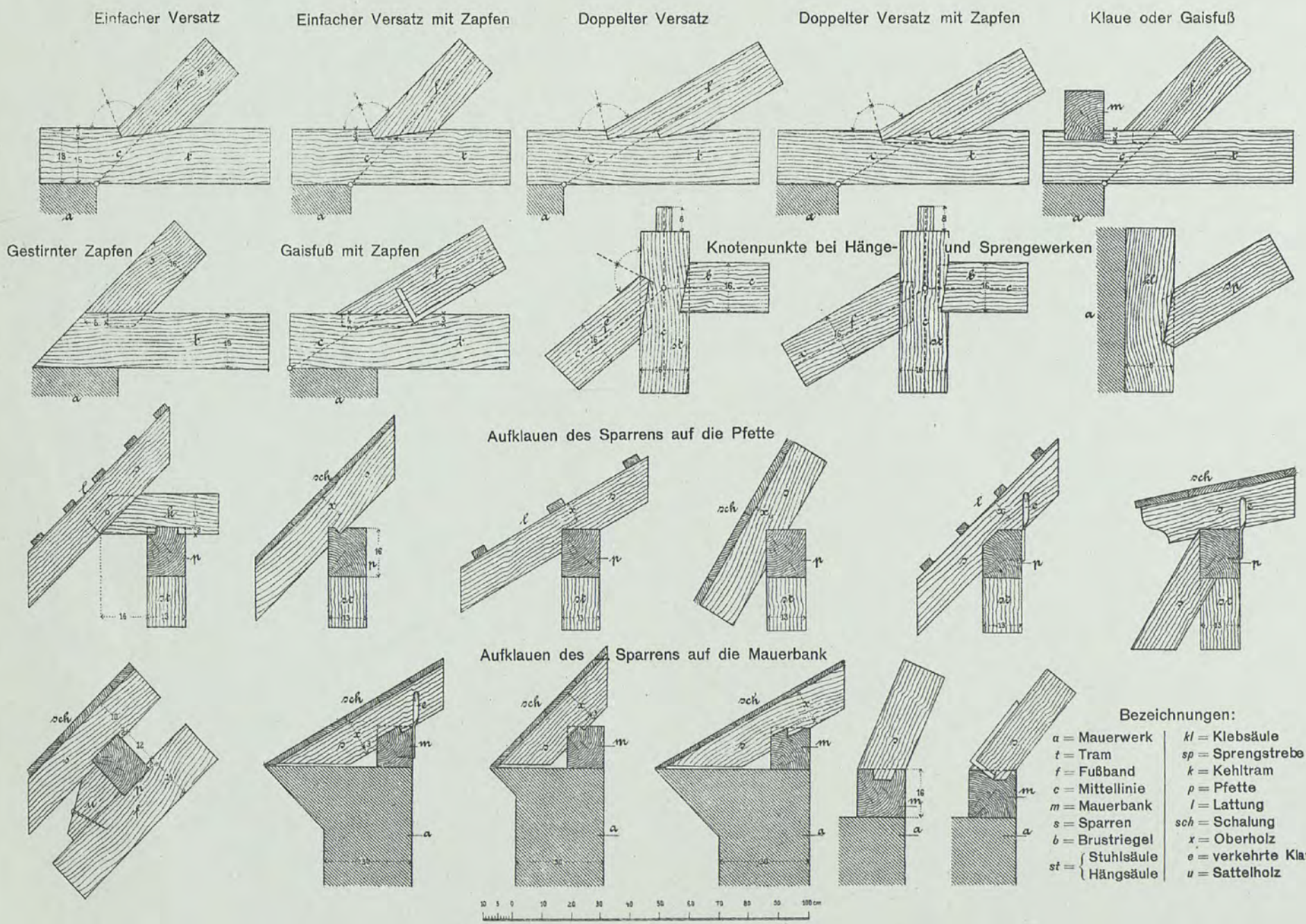
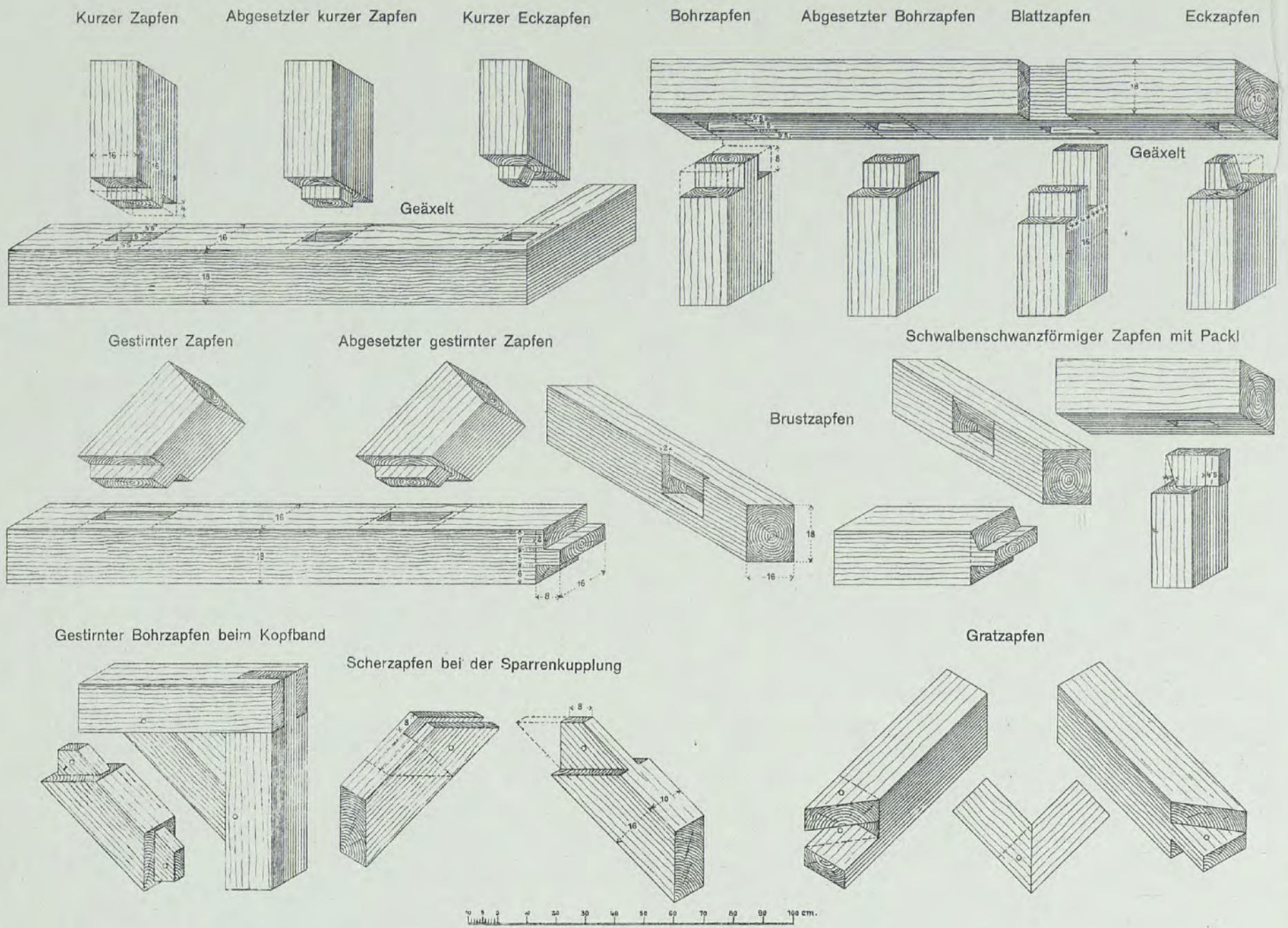

- Bezeichnungen:
- a = Mauerwerk
 - t = Tram
 - f = Fußband
 - c = Mittellinie
 - m = Mauerbank
 - s = Sparren
 - b = Brustriegel
 - st = { Stuhlsäule
Hängsäule
 - kl = Klebsäule
 - sp = Sprengstrebe
 - k = Kehltram
 - p = Pfette
 - l = Lattung
 - sch = Schalung
 - x = Oberholz
 - e = verkehrte Klammer
 - u = Sattelholz

DER ZIMMERERMEISTER, I. TEIL, Nr. 2
HOLZVERBINDUNGEN



Werksatz mit Grat-, Ichen-, Laden- und Wandschiftern

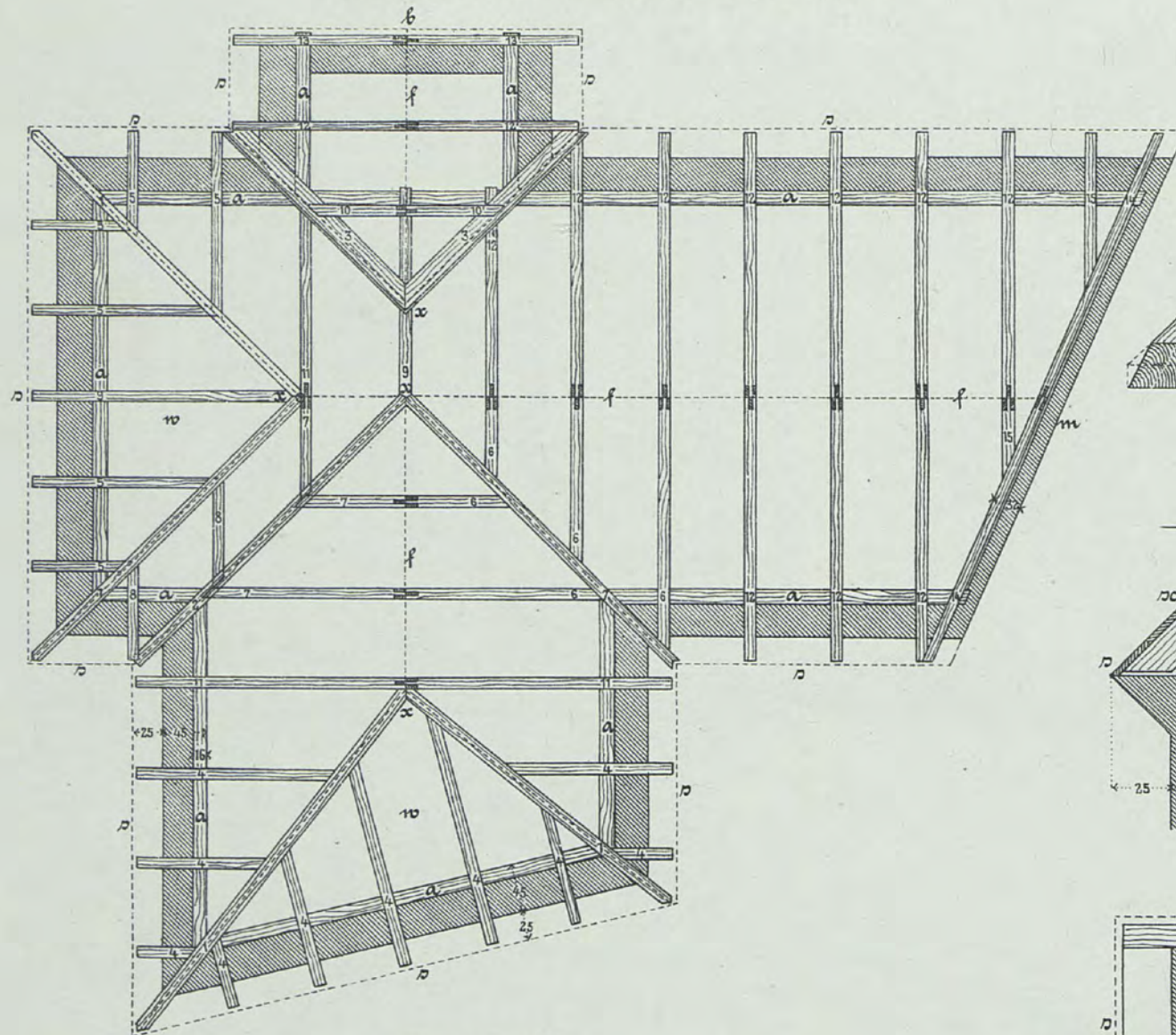

Ladenschiftung bei einem Anbau

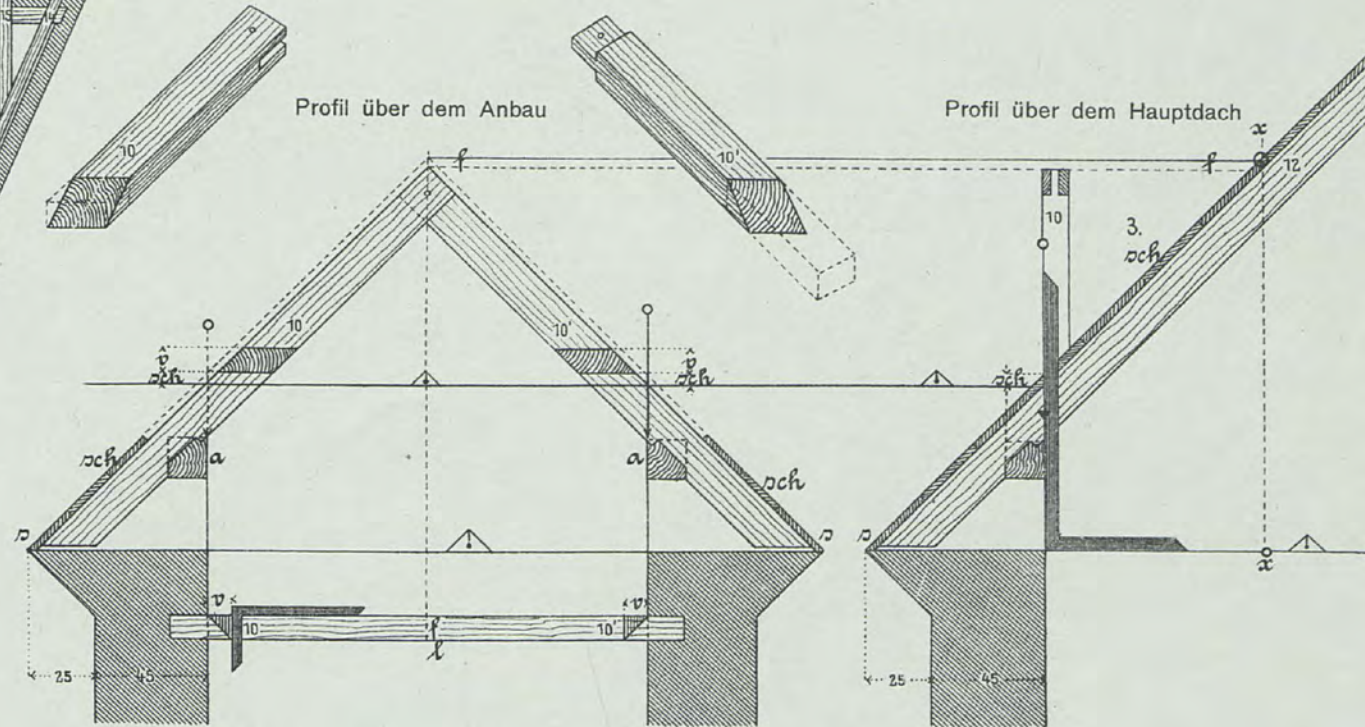

Bezeichnungen:

- | | |
|---------------------------------|---|
| 1 = Gratsparren | a = Mauerbank |
| 2 = Ichen-sparren | b = Giebel |
| 3 = Schalung zur Ladenschiftung | f = First |
| 4 = glatte Gratschifter | l = Schiftlatte |
| 5 = Gratklauenschifter | m = Feuermauer |
| 6 = glatte Ichen-schifter | s = Saum |
| 7 = Ichenklauenschifter | sch = Dachschalung und
Schalungsschmiege |
| 8 = Doppelschifter | v = Verstechung |
| 9 = Mittelschifter | w = Walm |
| 10 = Ladenschifter | x = Anfallspunkt |
| 11 = Anfallgespärre | △ = Wagriß |
| 12 = Normalgespärre | ↓ = Lotriß |
| 13 = Giebelgespärre | |
| 14 = Wandgespärre | |
| 15 = Wandschifter | |

Werksatz

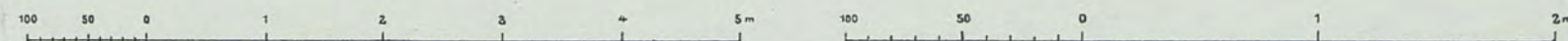
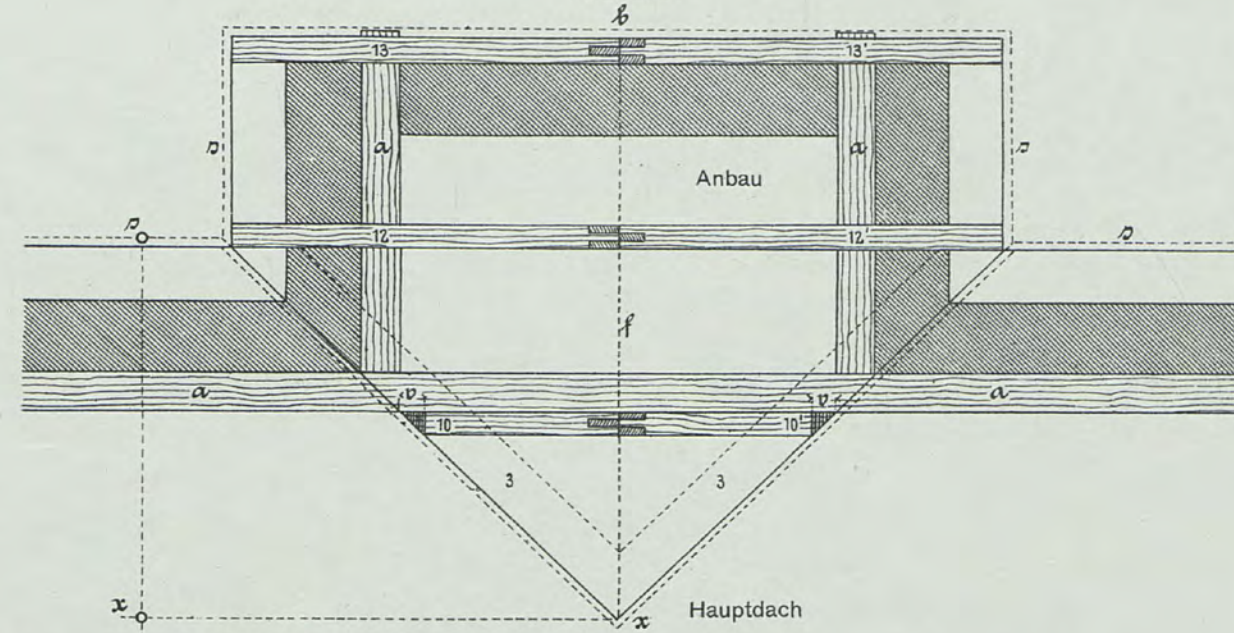

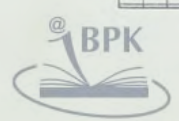
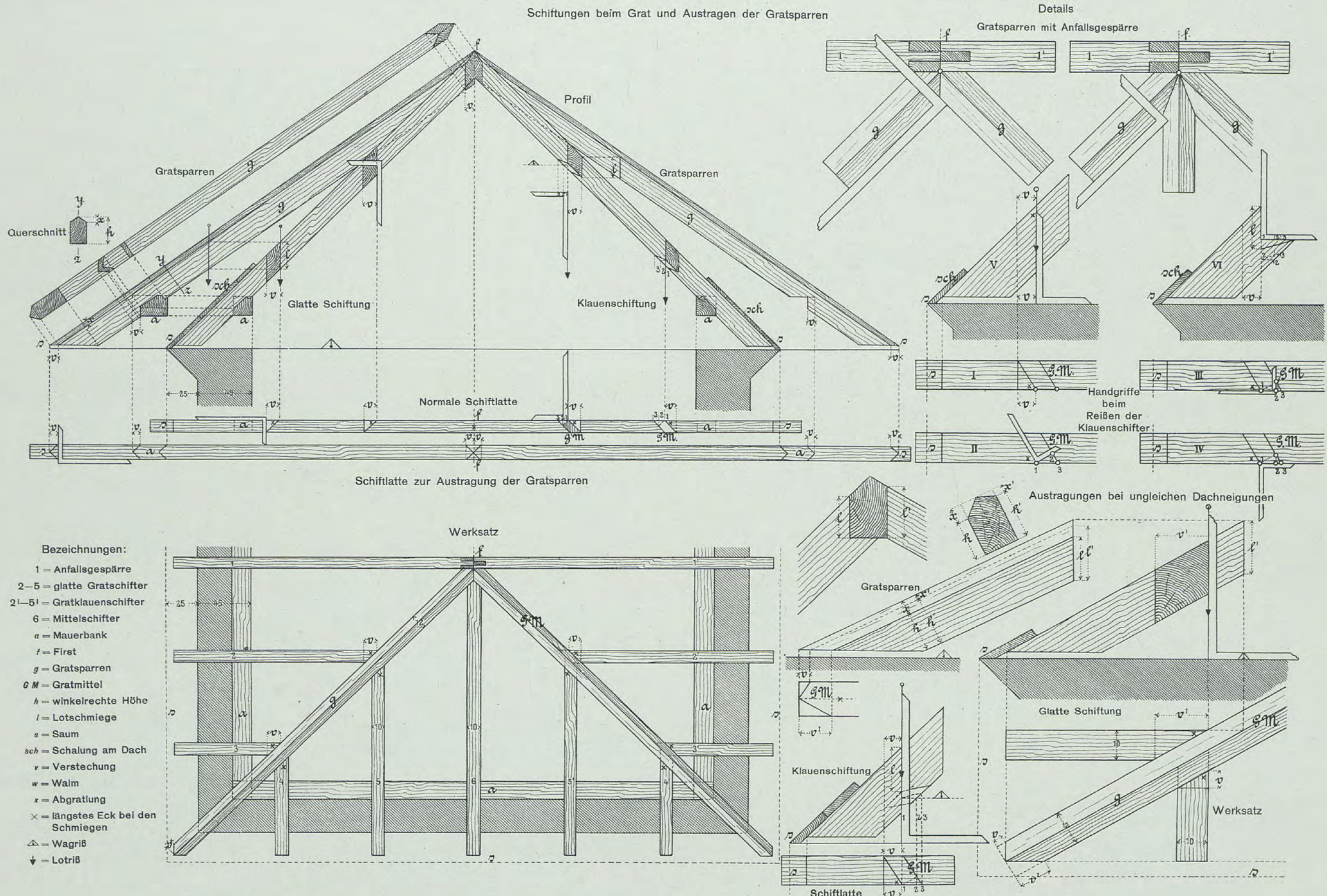

Schiftungen bei der Ichse und Austragen der Ichsensparren

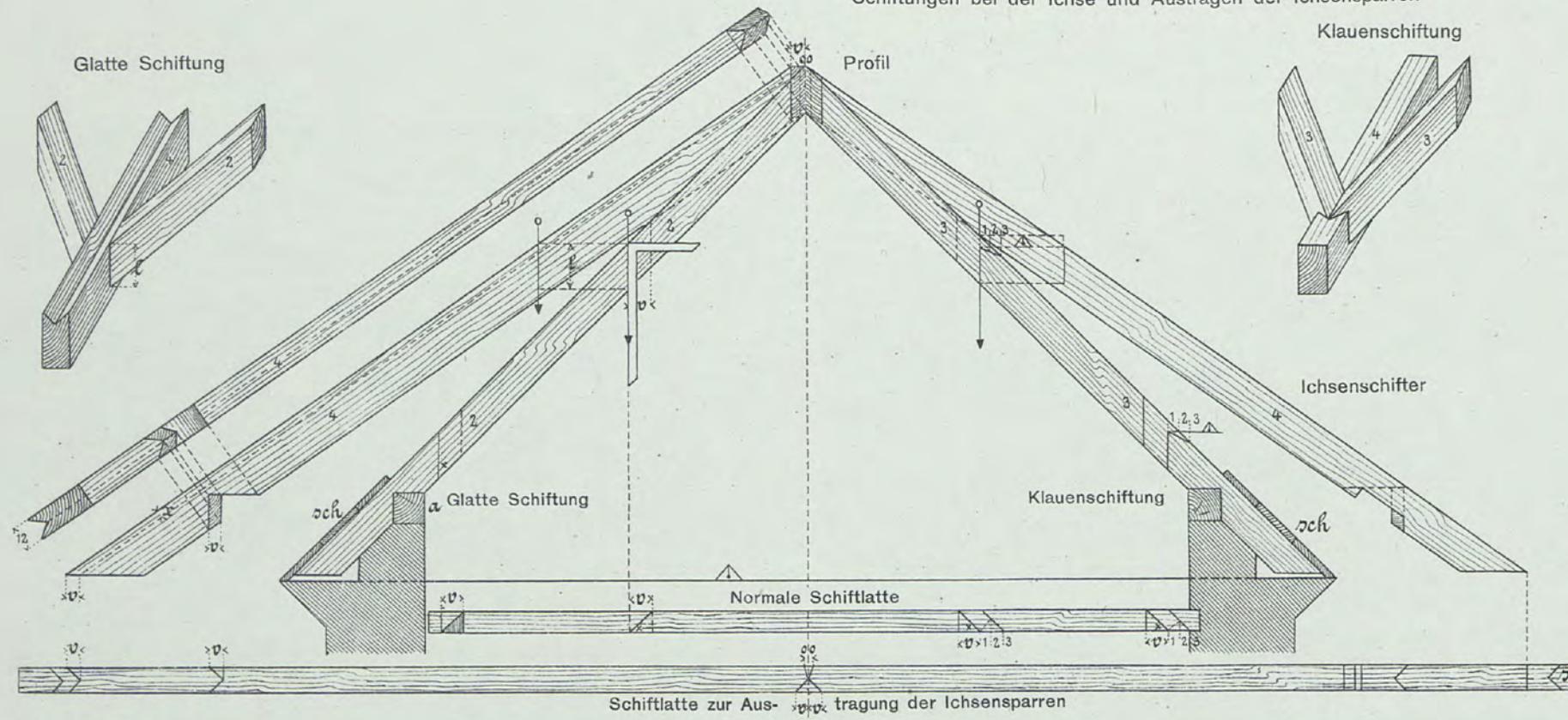

Klauenschiftung

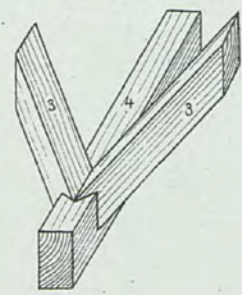

Ichsensparren

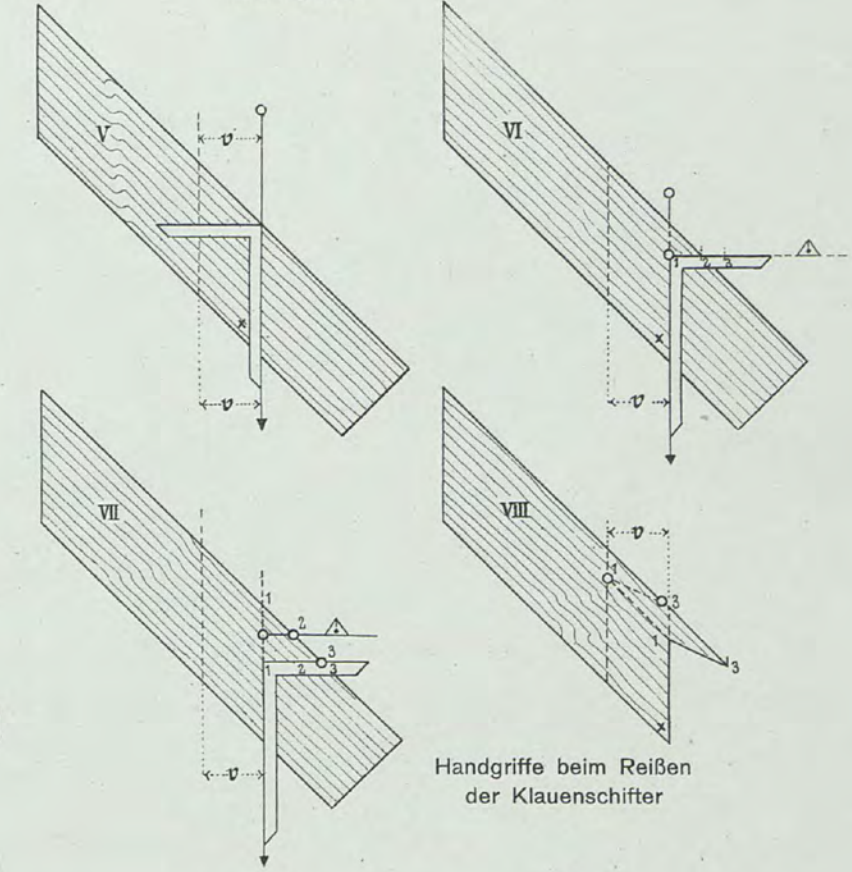

Handgriffe beim Reißen der Klauenschifter

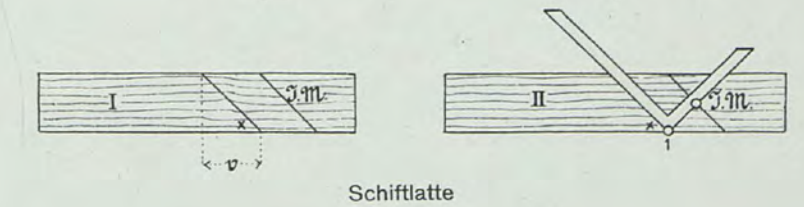

Schiftlatte

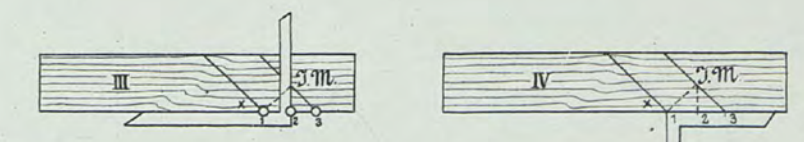

Knotenpunkt beim First

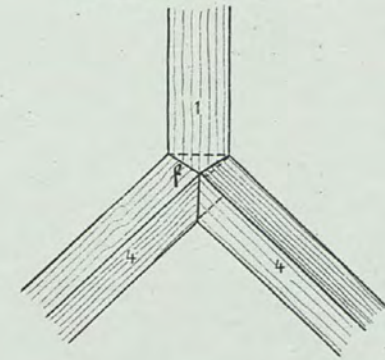

Klauenschifter bei flachen Dächern

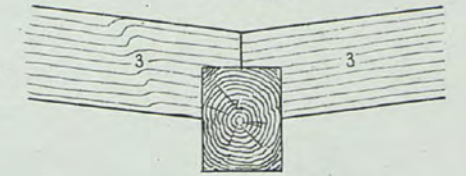

Bezeichnungen:

- 1 = Anfallsgespärre
- 2 = glatte Ichschifter
- 3 = Ichsenklauenschifter
- 4 = Ichsensparren
- 5 = Normalgespärre
- a = Mauerbank
- f = First
- JM = Ichsenmittel
- l = Lotschmiege
- s = Saum
- sch = Schalung am Dach
- v = Verstechung
- x = Ausarbeitung
- X = längstes Eck bei den Schmiegen
- △ = Wagriß
- ∇ = Lotriß

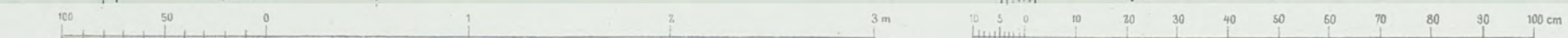
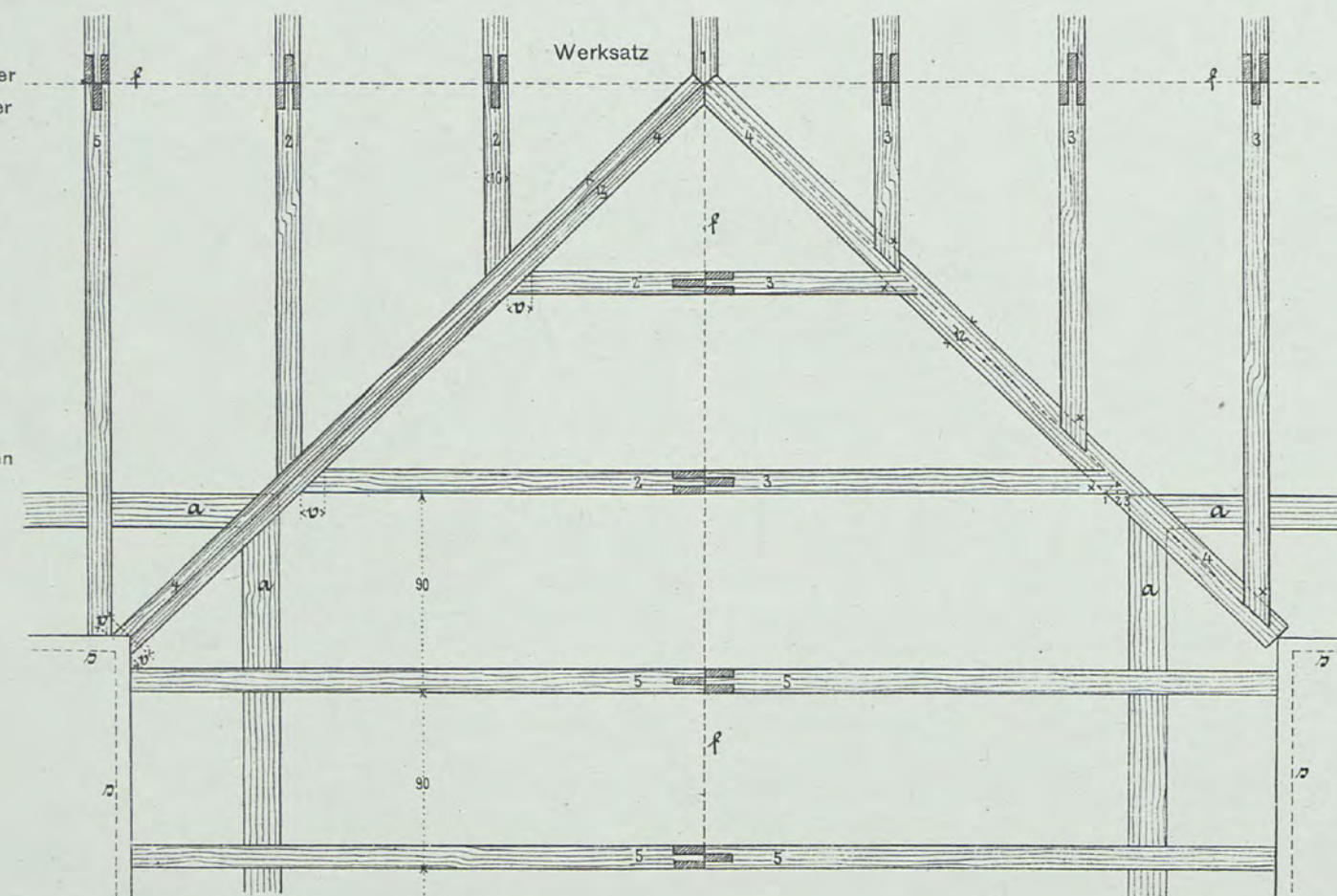

Werksatz mit Sparrenlage

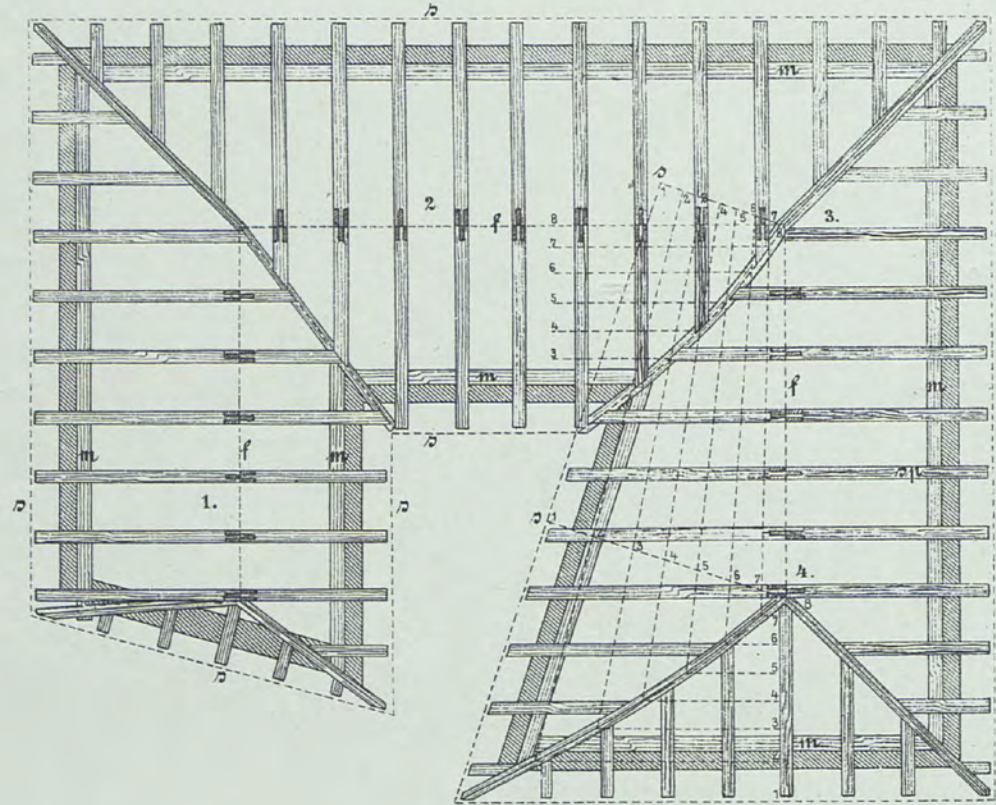

Profil 4
 Austragen der Abgratung

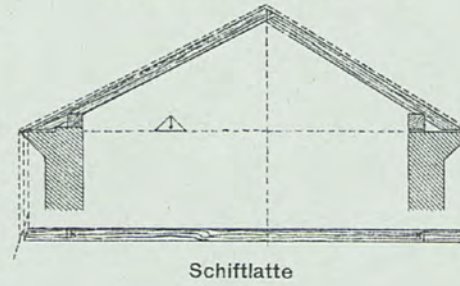

Ansicht

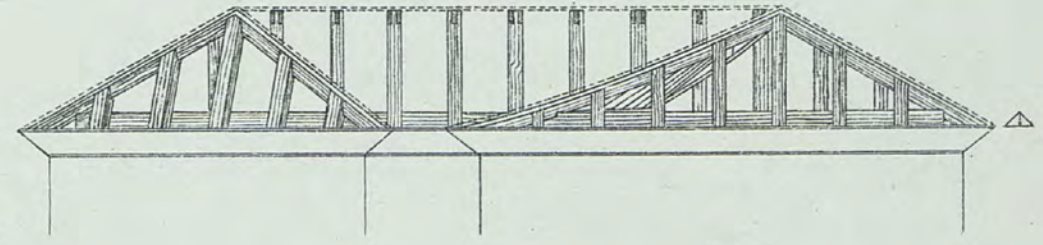

Schiffplatte

Profil 4 und Gratprofil

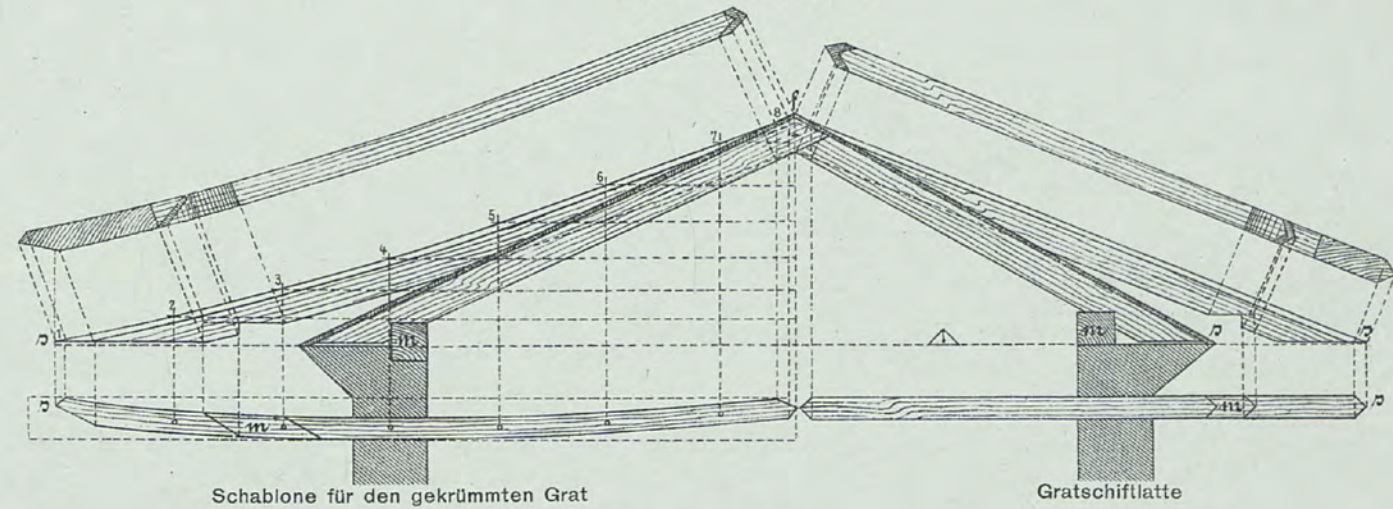

Schablone für den gekrümmten Grat

Gratschiffplatte

Profil 3

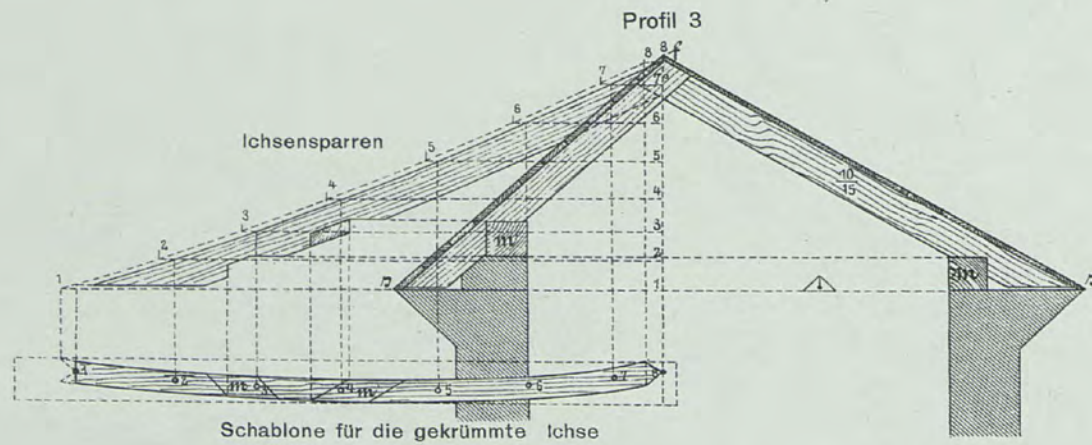

Schablone für die gekrümmte Ichse

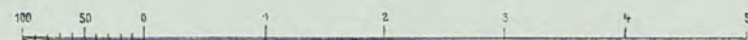
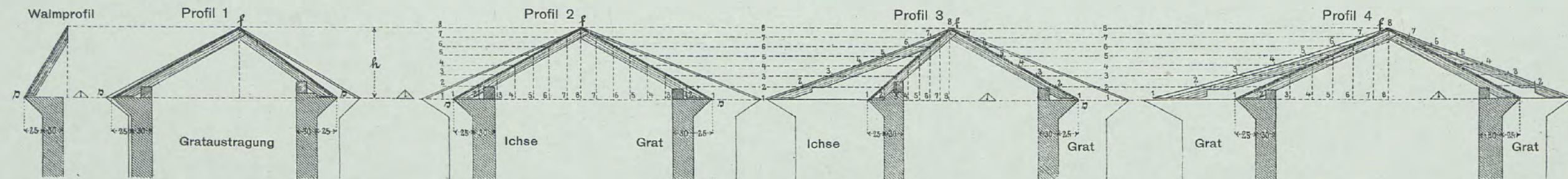

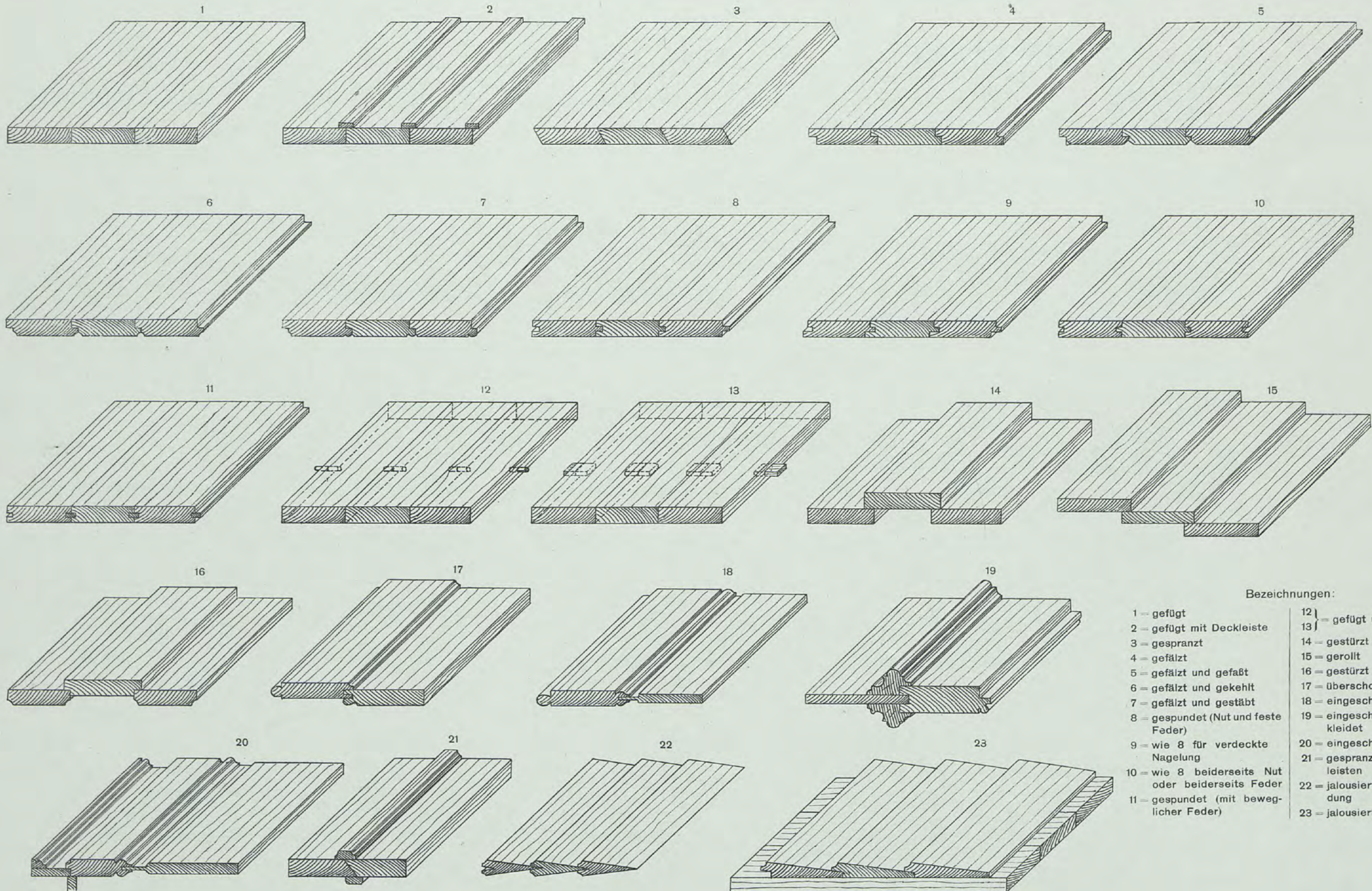

Bezeichnungen:

- | | |
|---|----------------------------------|
| 1 = gefügt | 12 } = gefügt und verdoppelt |
| 2 = gefügt mit Deckleiste | 13 } = gefügt und verdoppelt |
| 3 = gespranzt | 14 = gestürzt |
| 4 = gefälzt | 15 = gerollt |
| 5 = gefälzt und gefaßt | 16 = gestürzt und gefälzt |
| 6 = gefälzt und gekehlt | 17 = überschoben |
| 7 = gefälzt und gestäbt | 18 = eingeschoben |
| 8 = gespundet (Nut und feste Feder) | 19 = eingeschoben und verkleidet |
| 9 = wie 8 für verdeckte Nagelung | 20 = eingeschoben |
| 10 = wie 8 beiderseits Nut oder beiderseits Feder | 21 = gespranzt mit Schlagleisten |
| 11 = gespundet (mit beweglicher Feder) | 22 = jalousiert mit Keilspundung |
| | 23 = jalousiert und gefälzt |

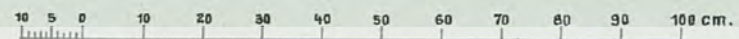

Austragen eines gleichbreiten Gesimses mit verschiedenen Neigungen

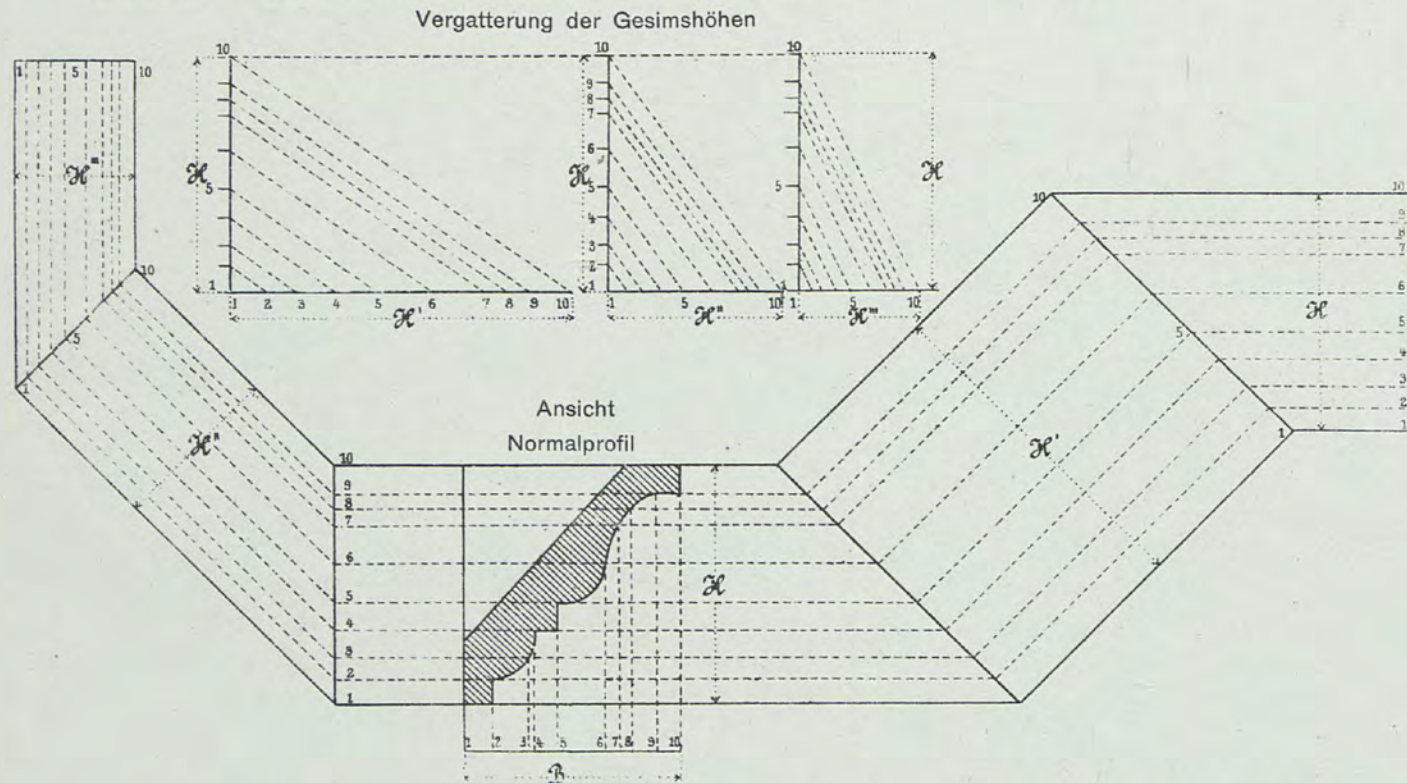

Austragen der Schablone für den geschweiften Gratsparren

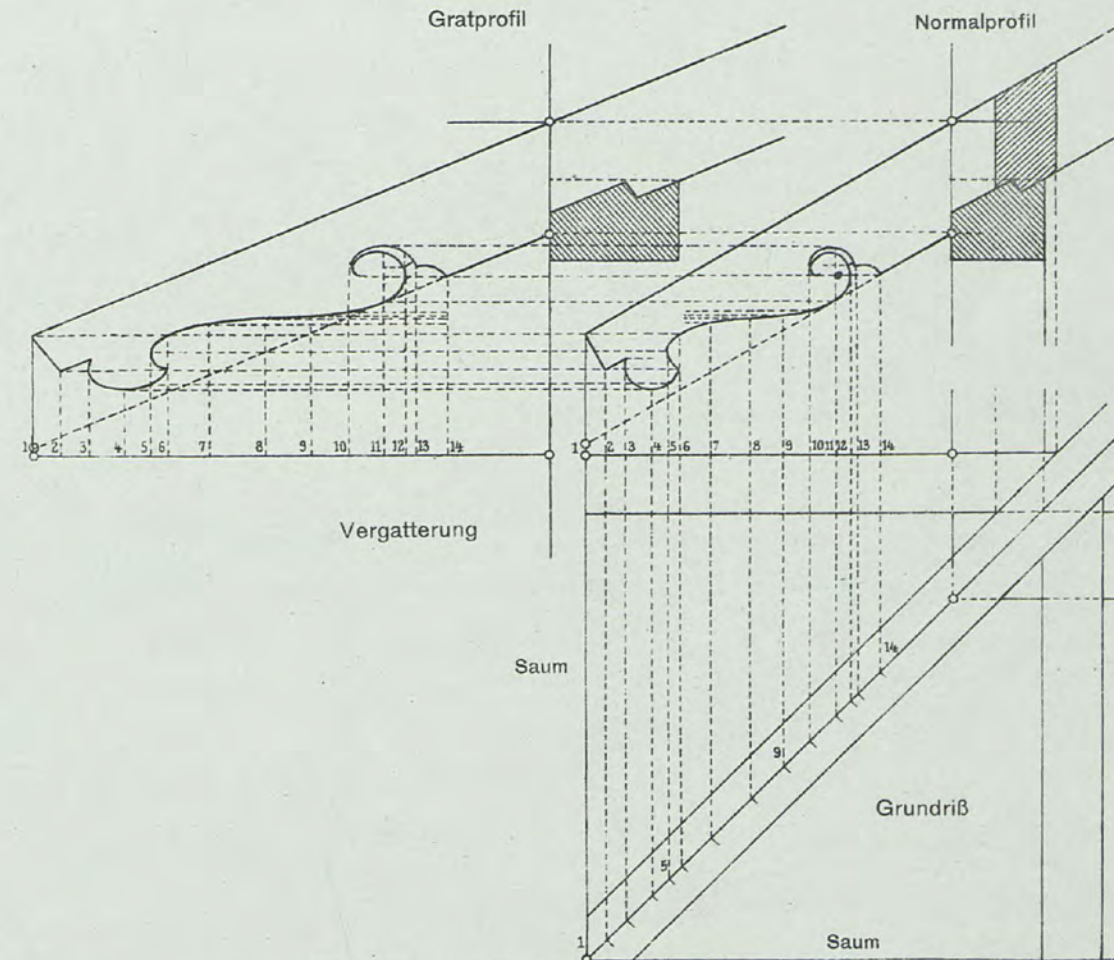

Austragen der Profile

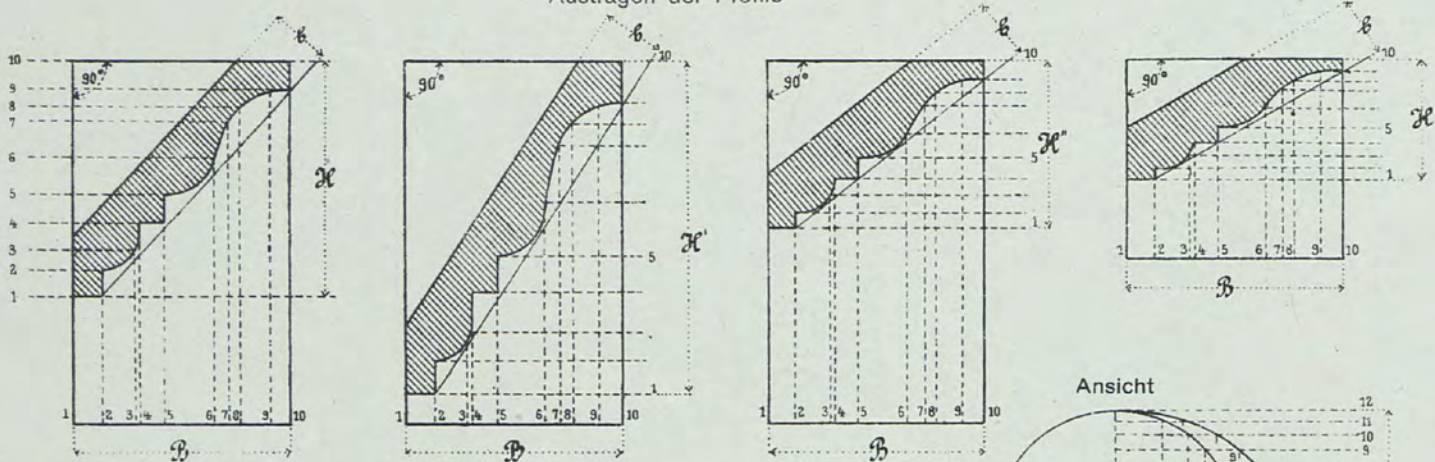

Austragen der Schablone für das geschweifte Ichsenkonsol

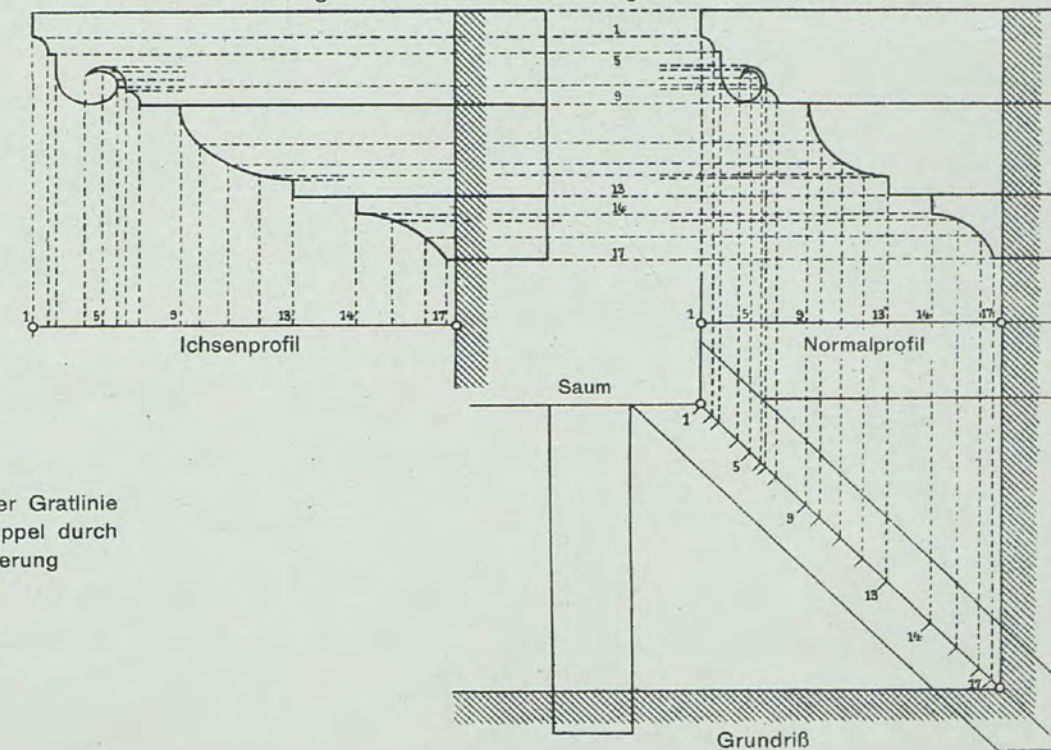

Austragen eines gleichbreiten Saum- und Giebelgesimses

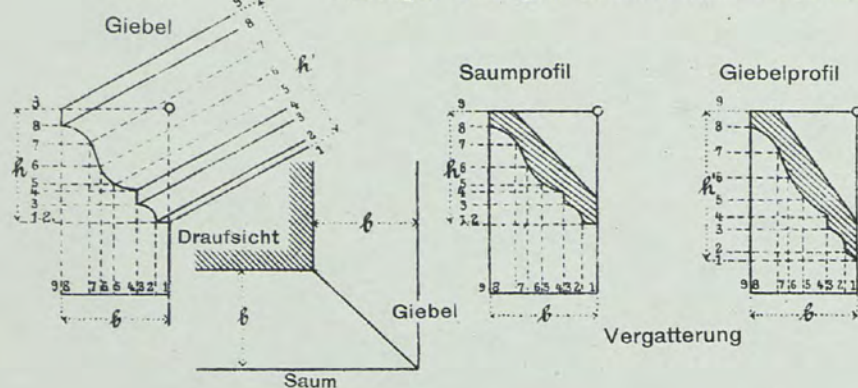

Ansicht

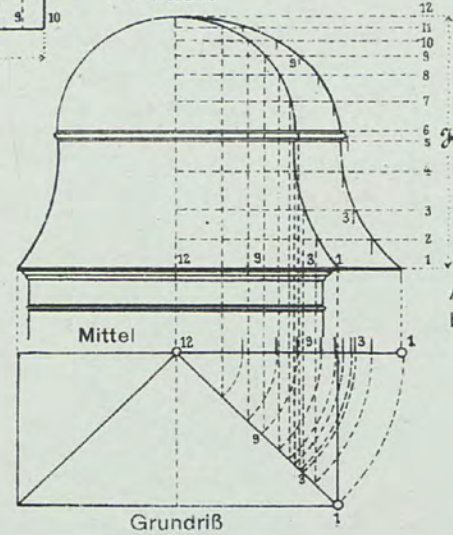

Austragen der Gratlinie bei einer Kuppel durch Vergatterung

DER ZIMMERERMEISTER, I. TEIL, Nr. 11
ANWENDUNG DER ARMIERTEN TRÄGER BEI EINEM HALLENDACH

Professor und Stadtzimmerermeister A. BAUDOIN, Wien

Entwurf: Architekt O. MORGENSTERN, Wien.

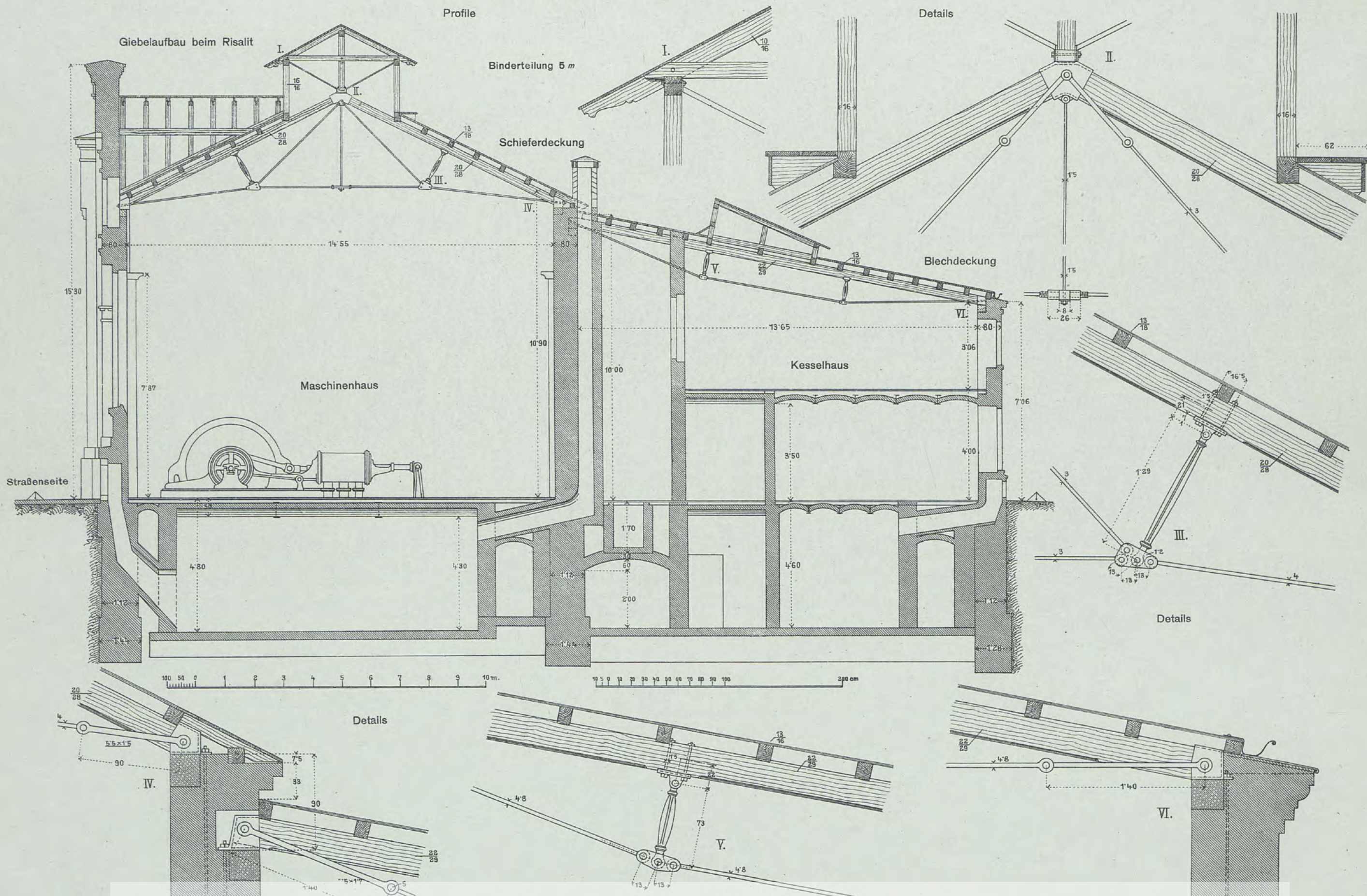

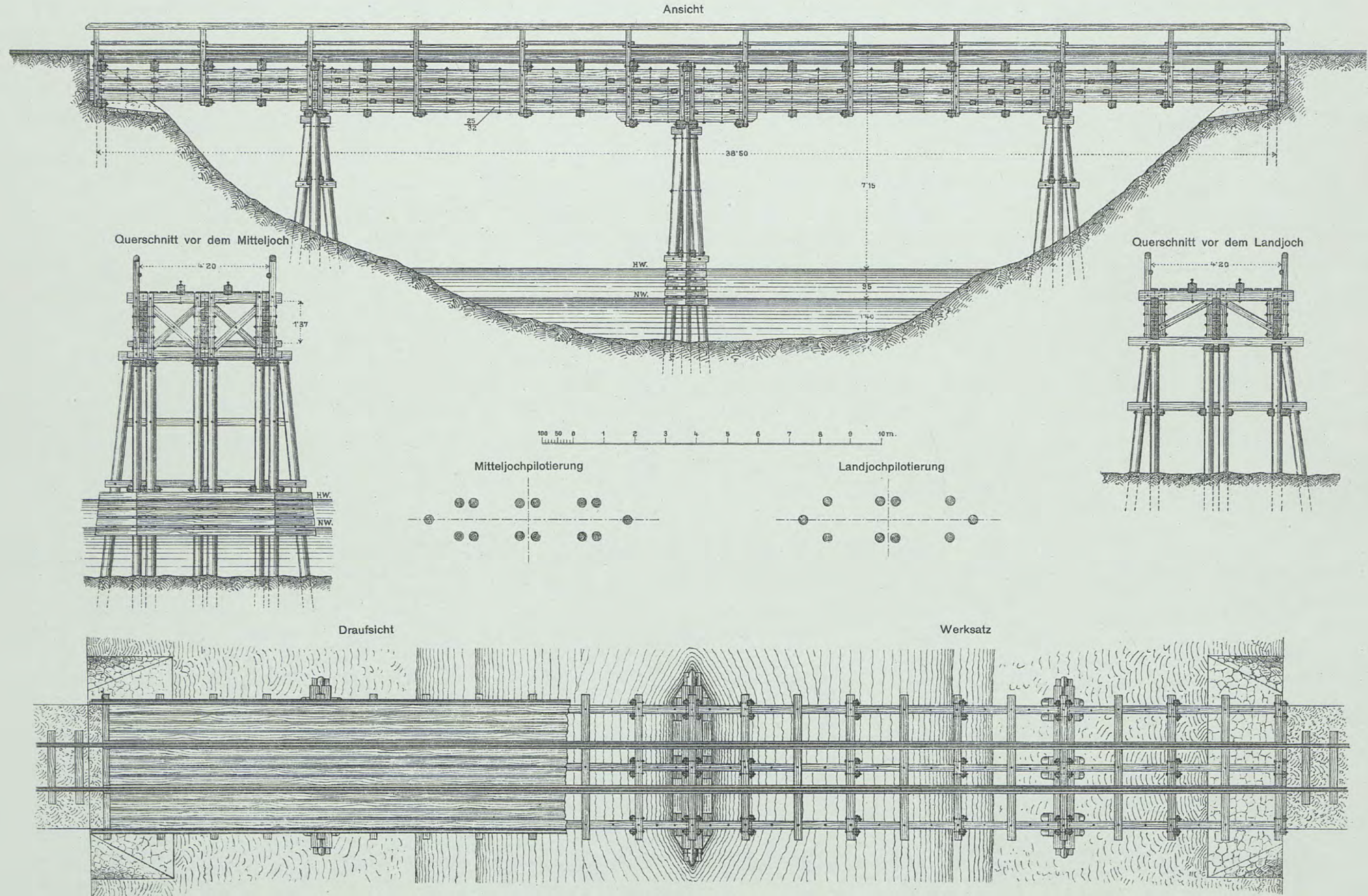

Doppelte Brückenträger aus je vier Hölzern

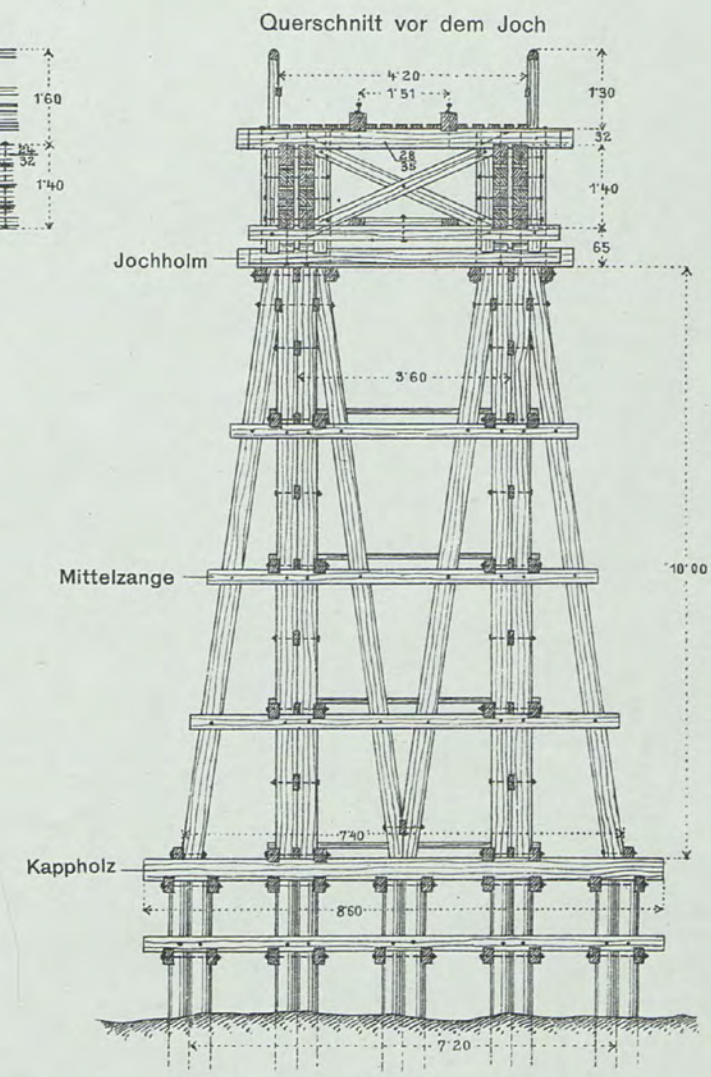
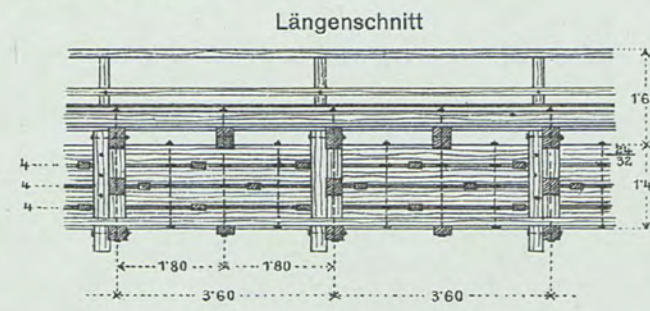
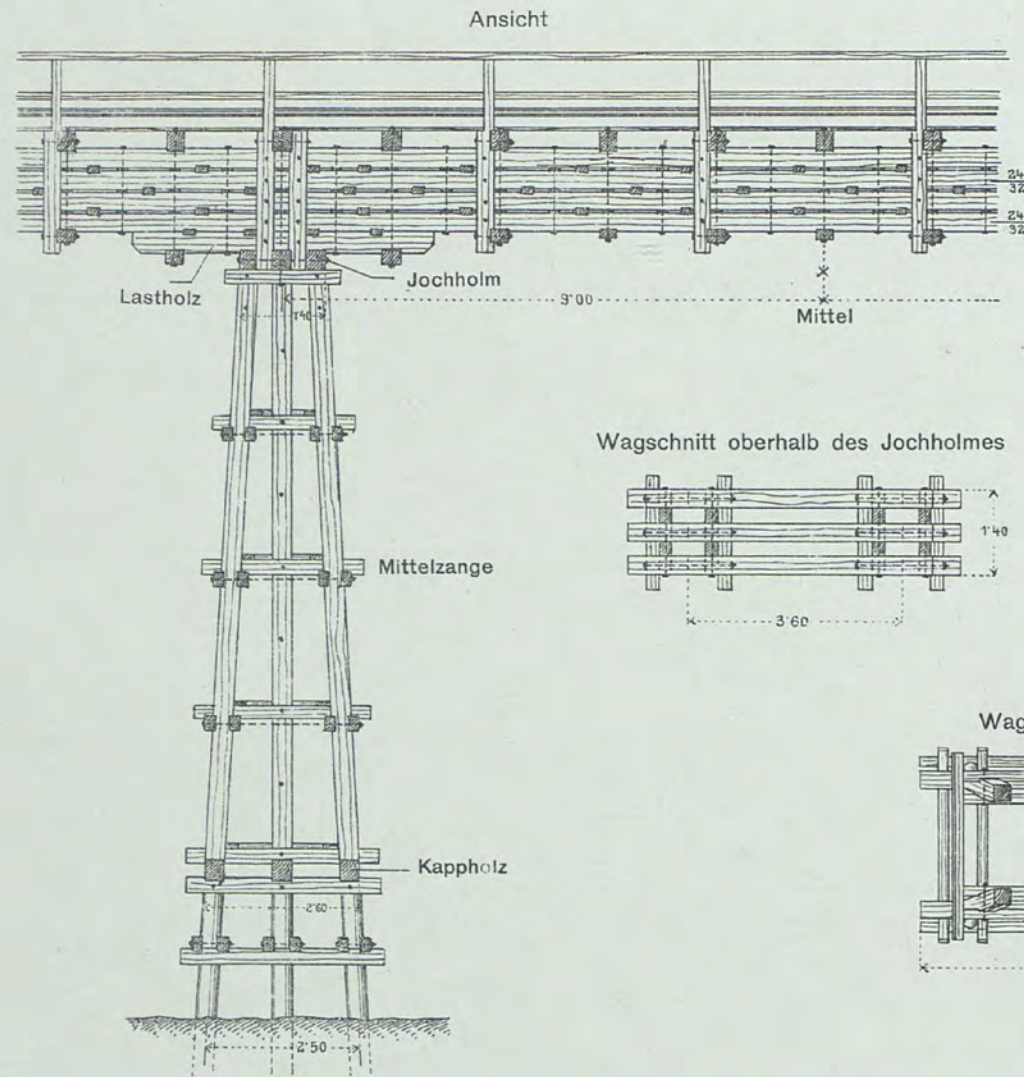

Wagschnitt oberhalb des Jochholmes

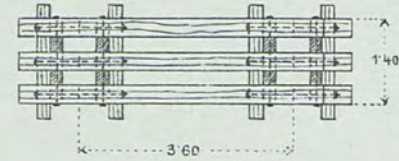

Wagschnitt oberhalb des Brückenträgers

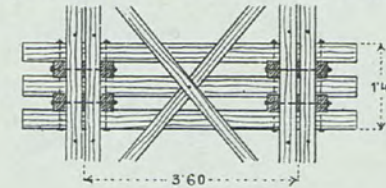

Wagschnitt unterhalb der Mittelzange

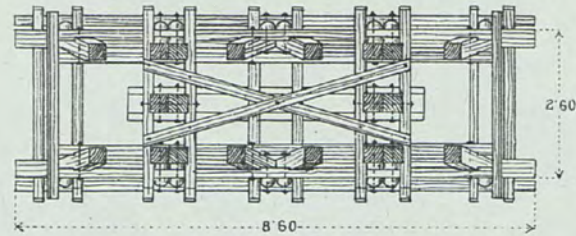

Wagschnitt oberhalb des Kappholzes

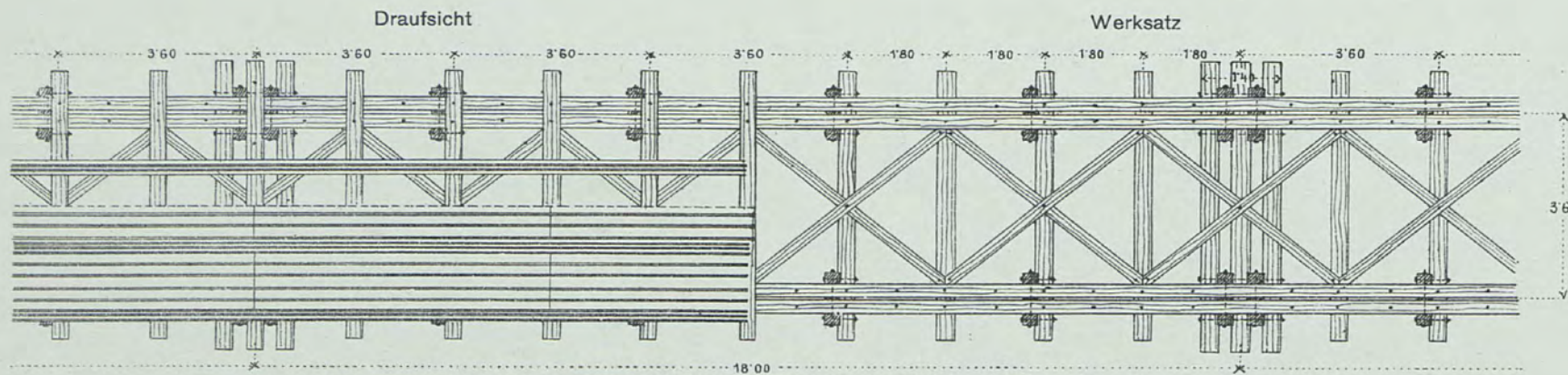
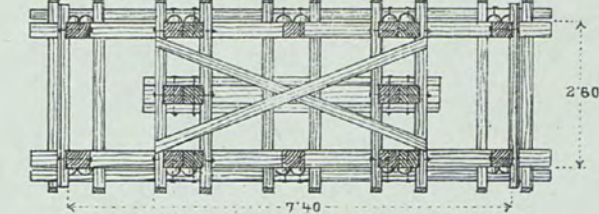

Jochpilotierung

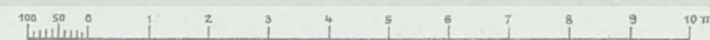
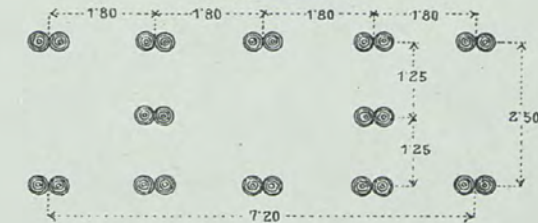

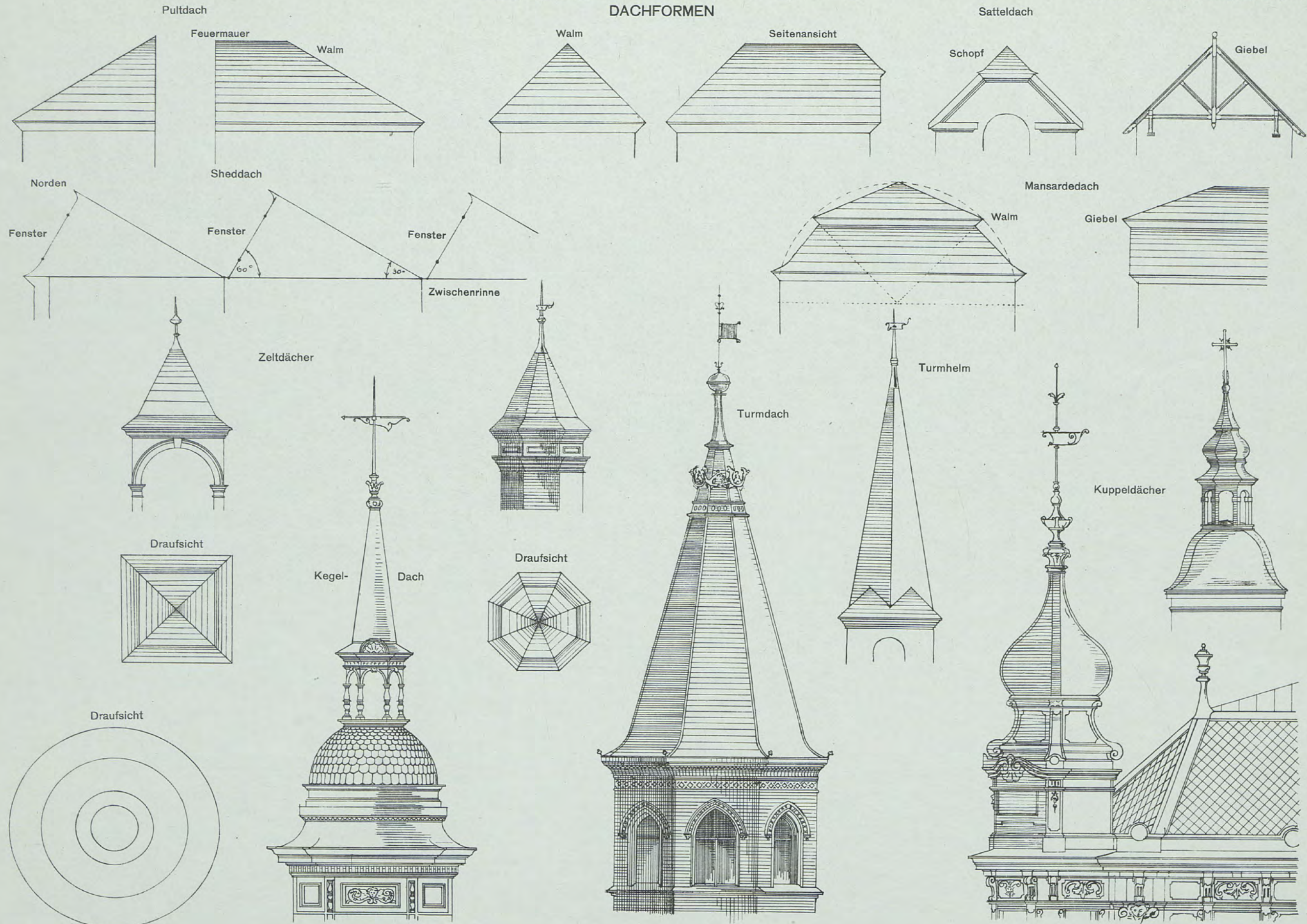

Umlegen der Dachflächen

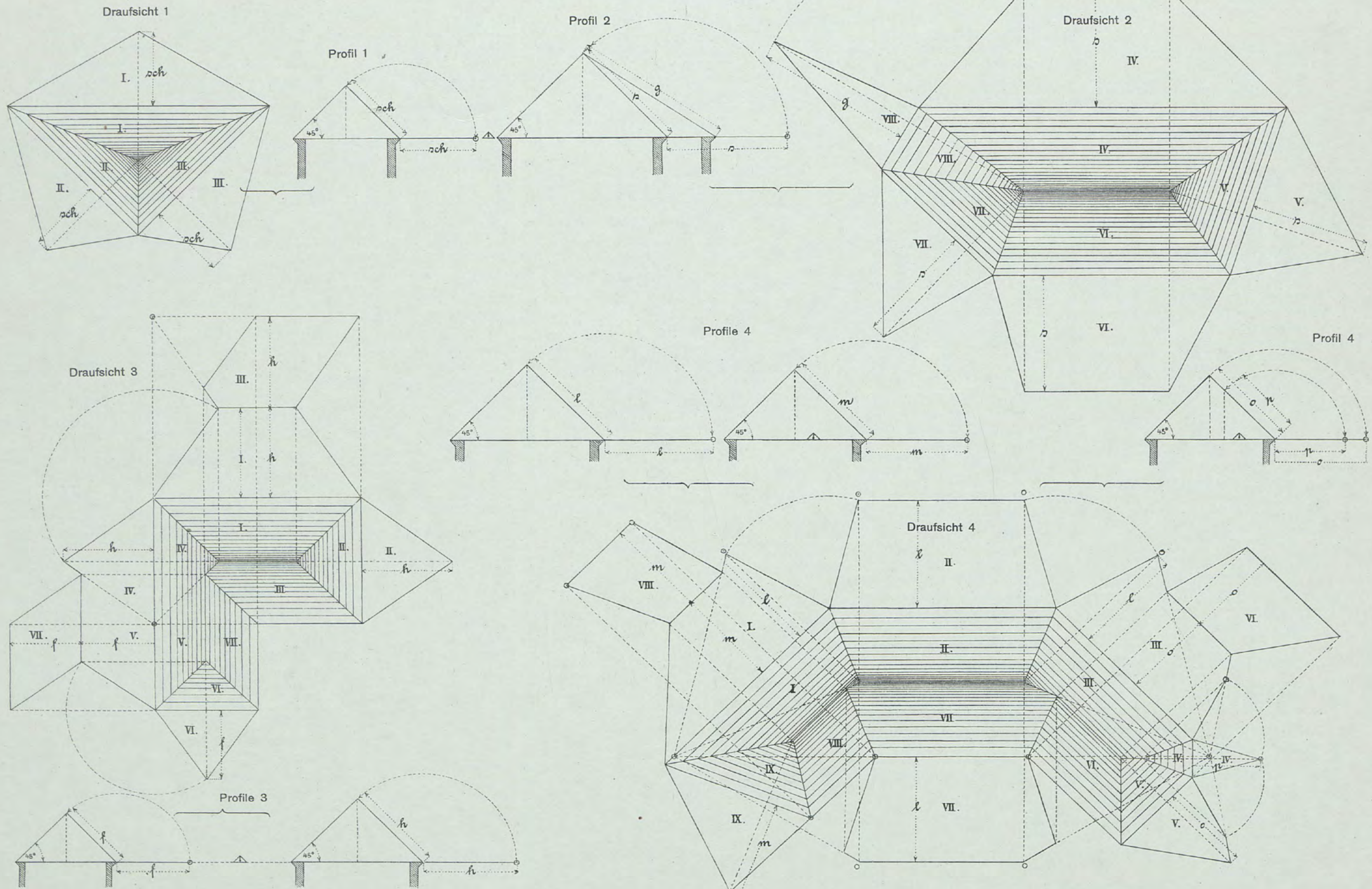

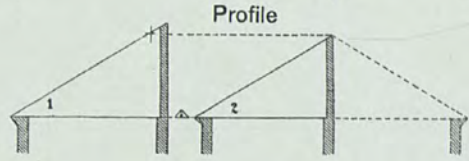
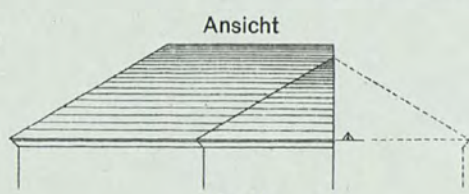
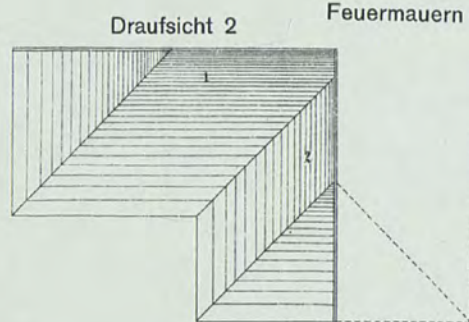
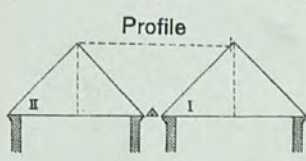
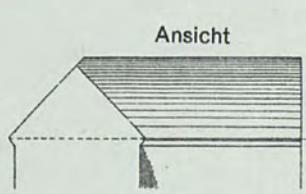
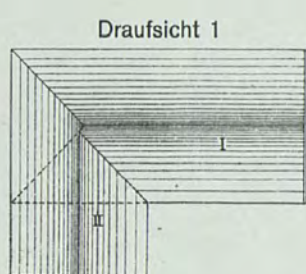
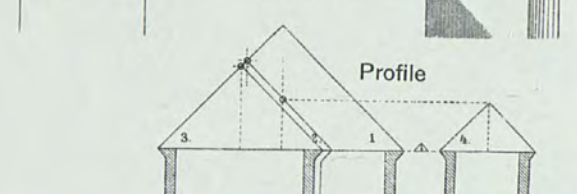
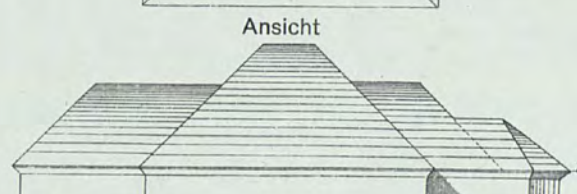
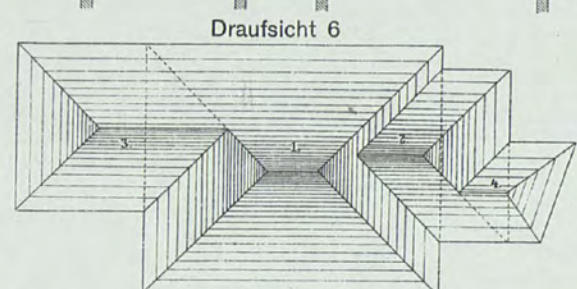
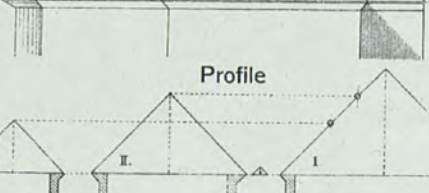
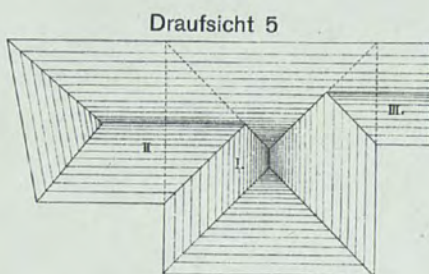
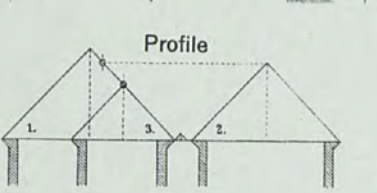
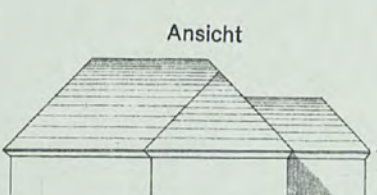
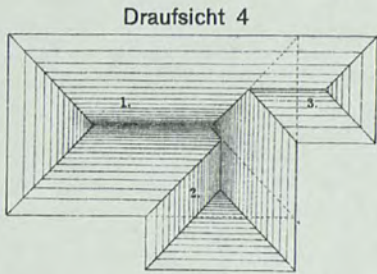
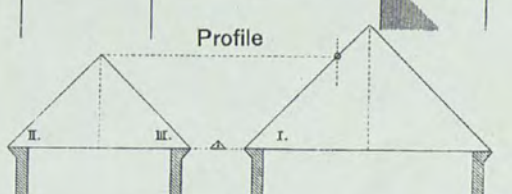
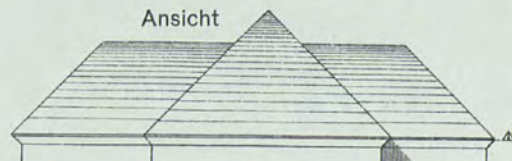
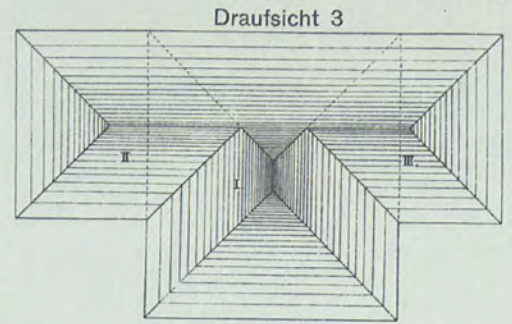
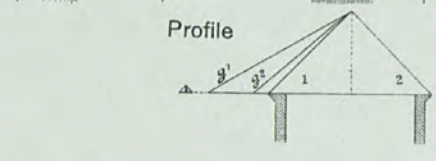
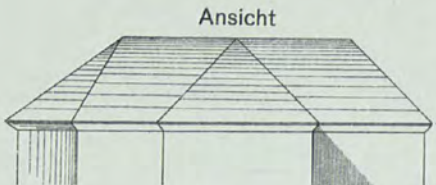
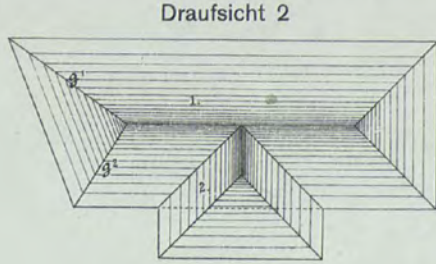
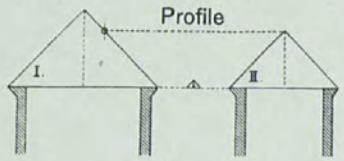
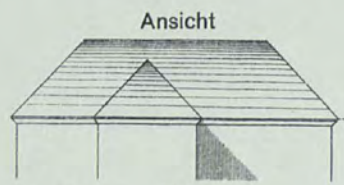
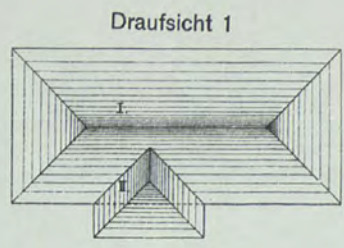

Feuermauern an der Nachbargrenze

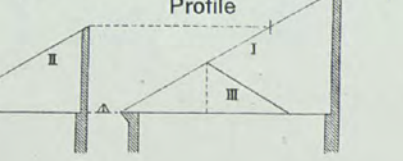
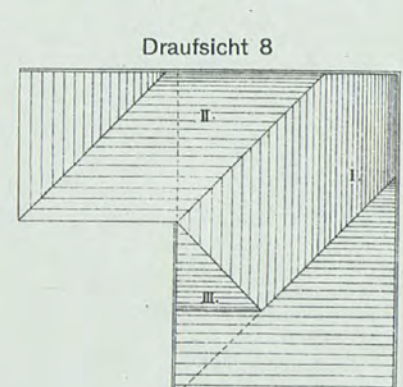
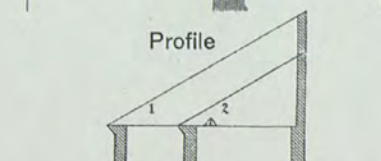
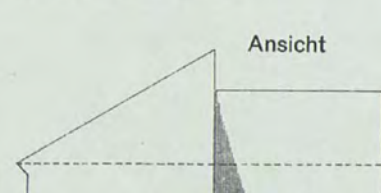
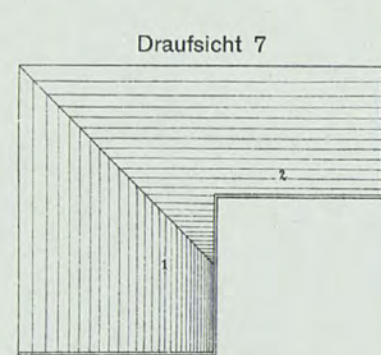
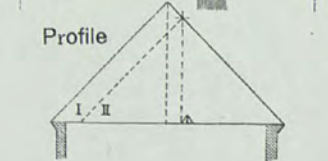
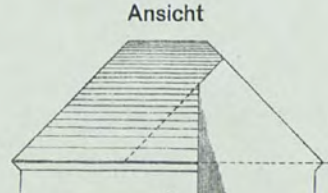
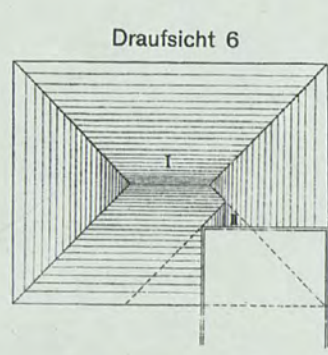
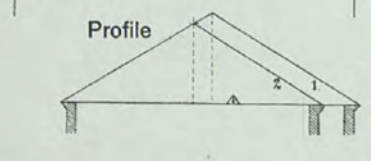
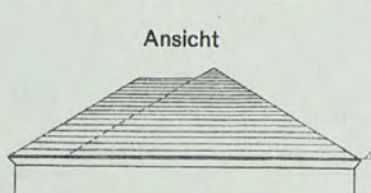
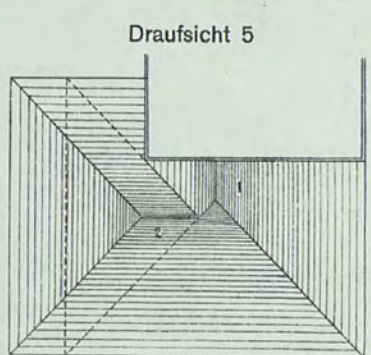
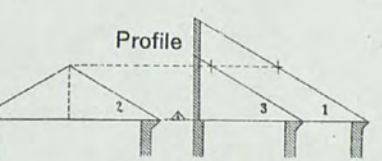
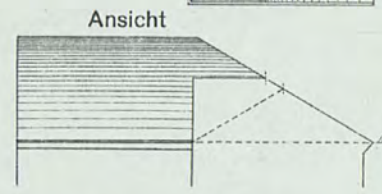
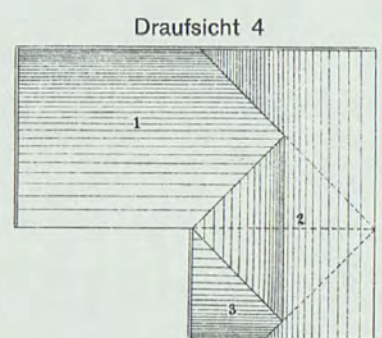
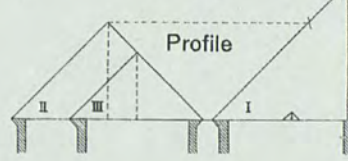
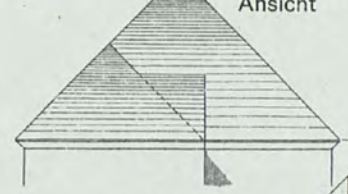
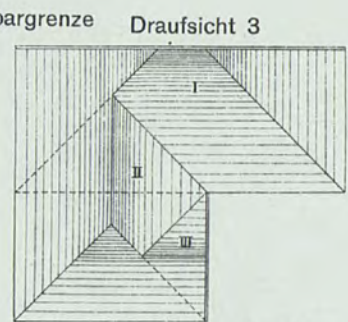

DER ZIMMERERMEISTER, I. TEIL, Nr. 17
 DACHAUSMITTLUNGEN MIT GLEICHEN SAUMHÖHEN UND GLEICHEN NEIGUNGEN

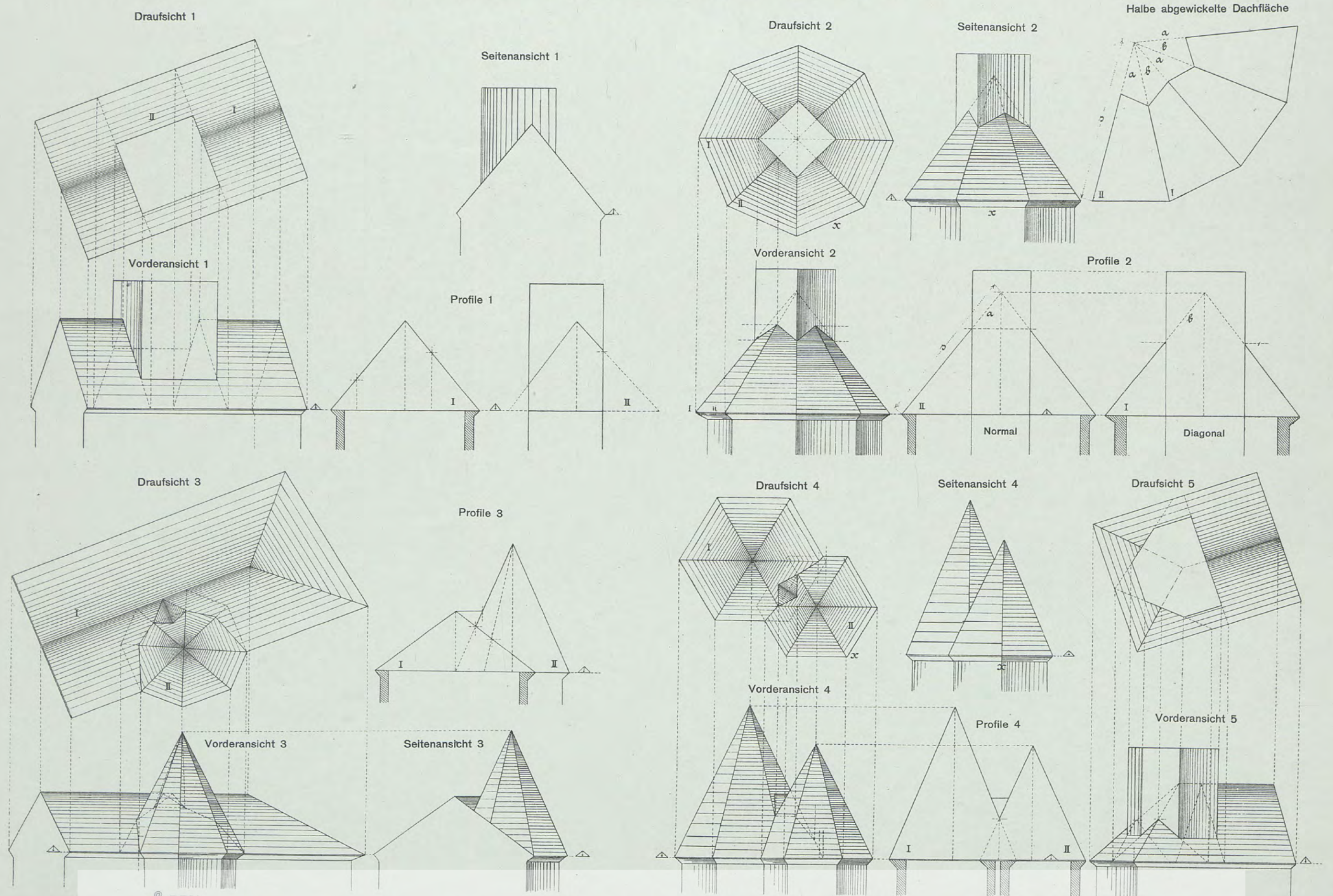

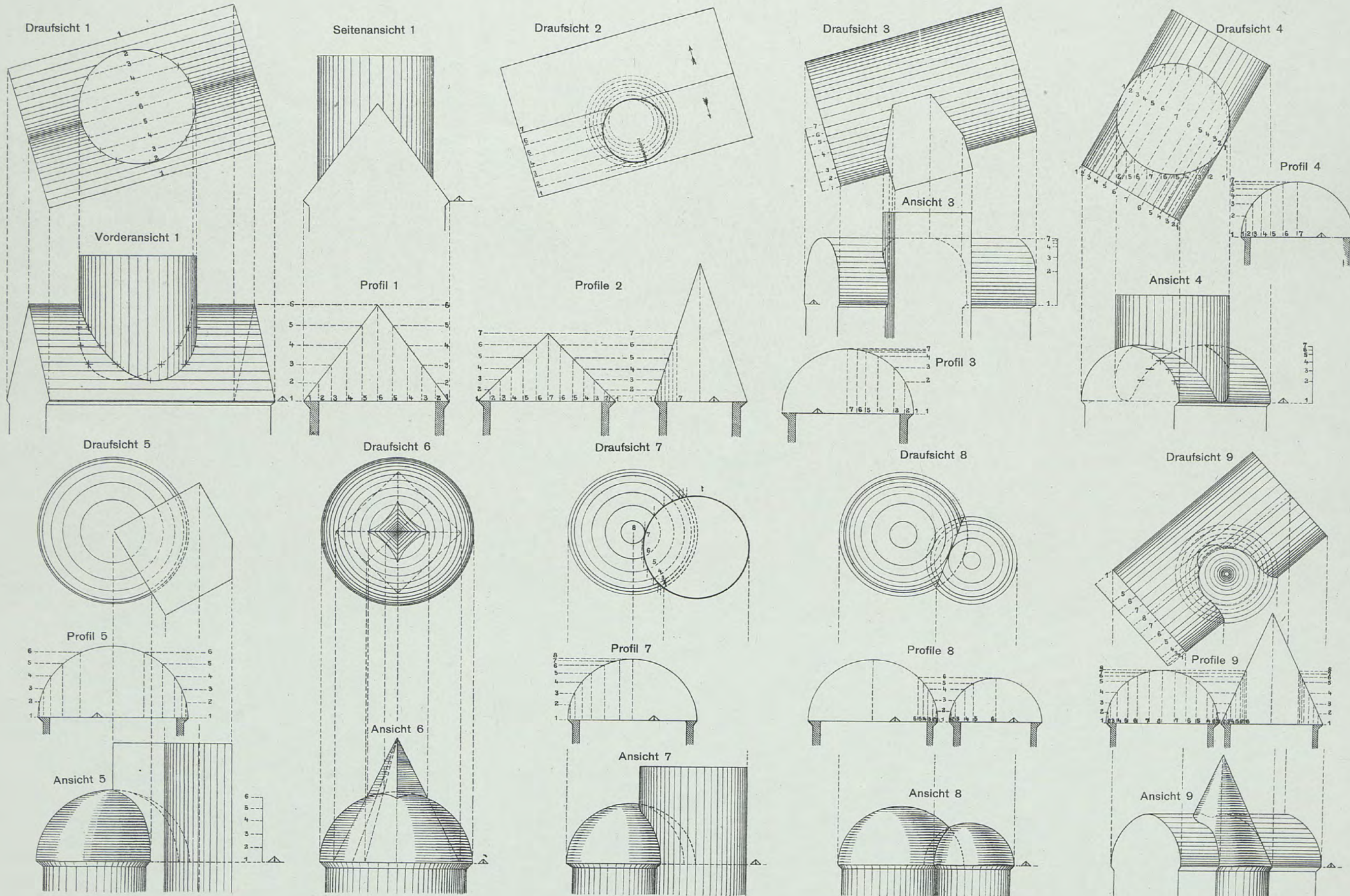

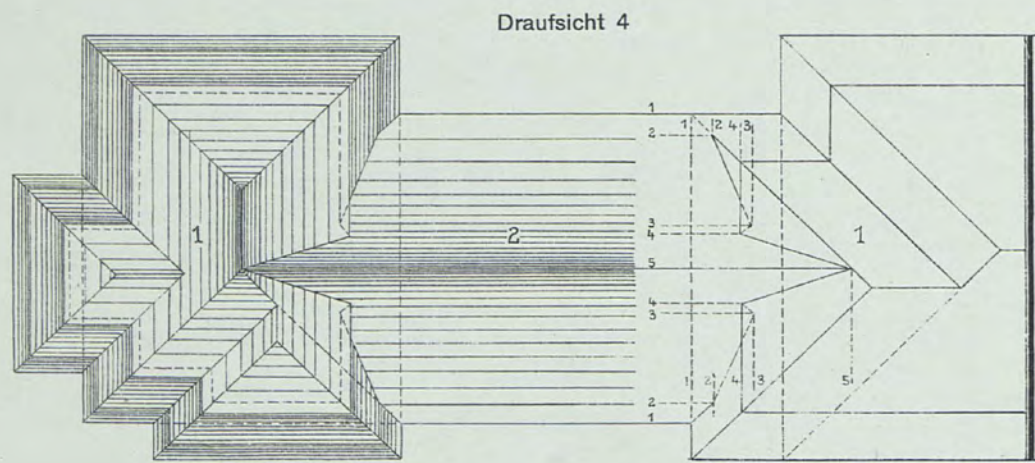
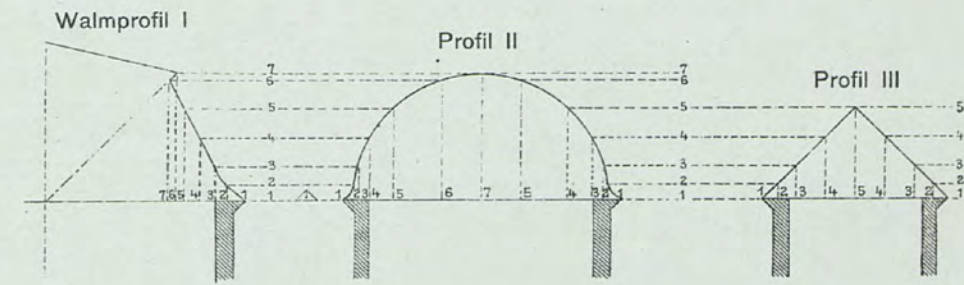
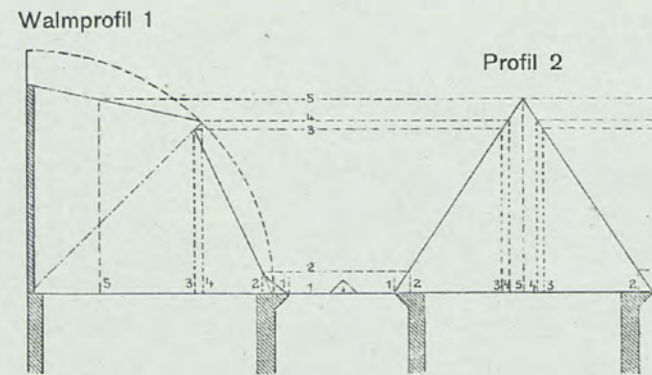
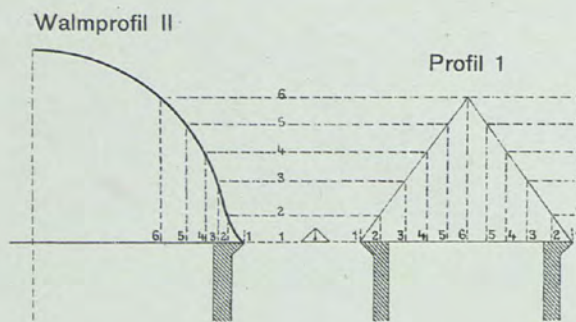
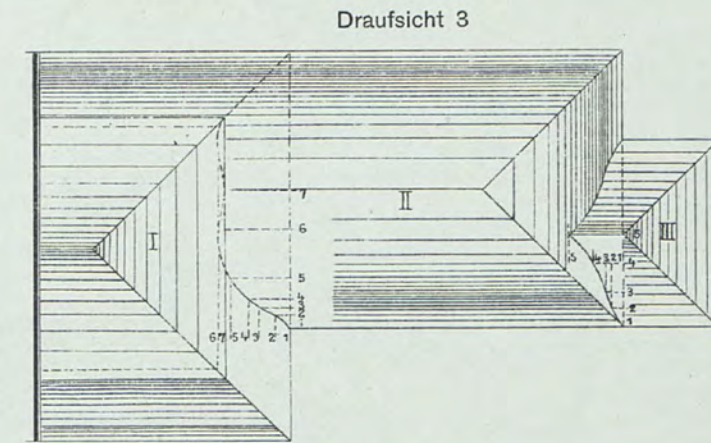
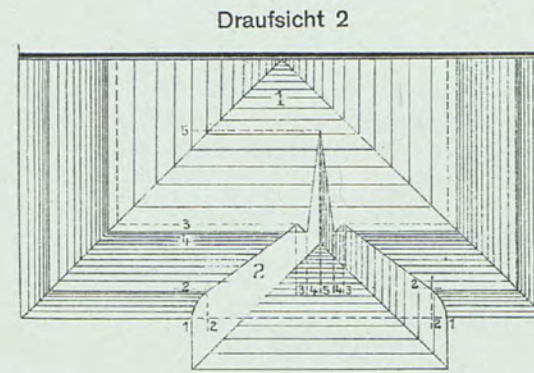
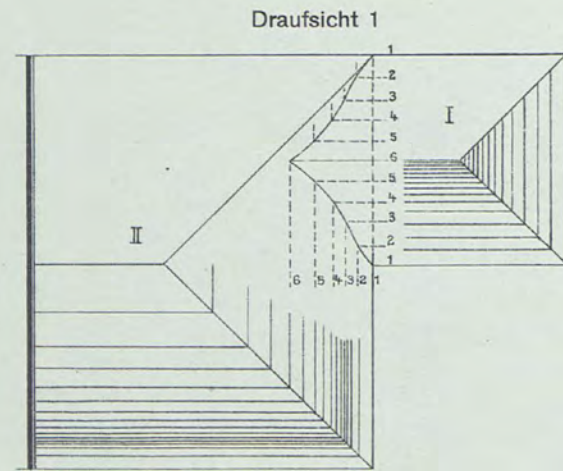

Dachausmittlungen durch Vergatterung

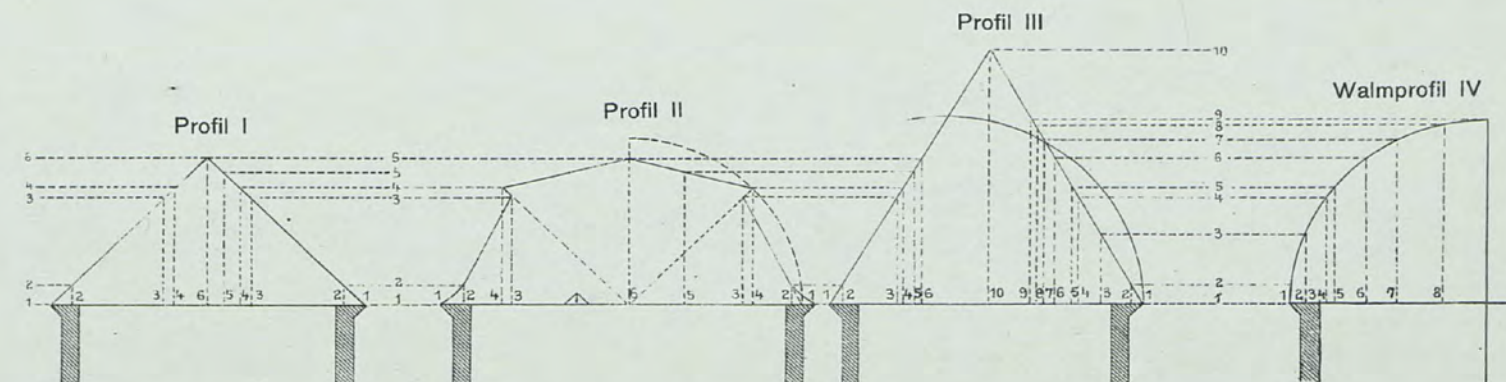
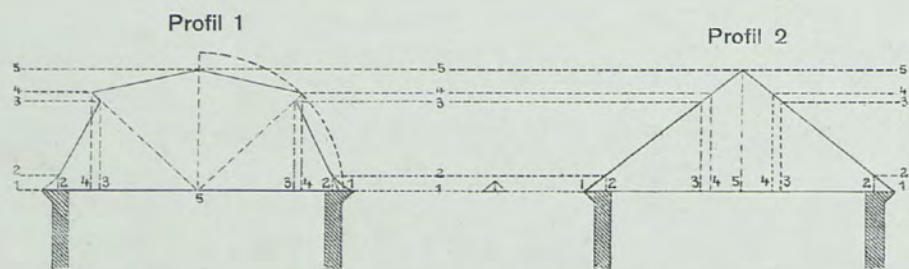
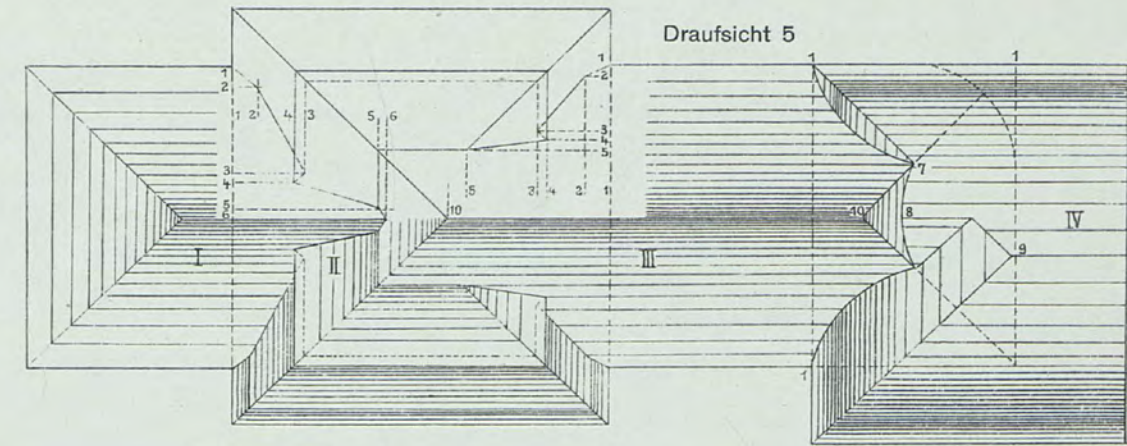

Die Neigung der steilen Flächen und die der Plattformen ist bei allen Mansarde-

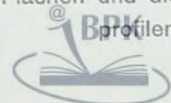

Tramauswechslungen

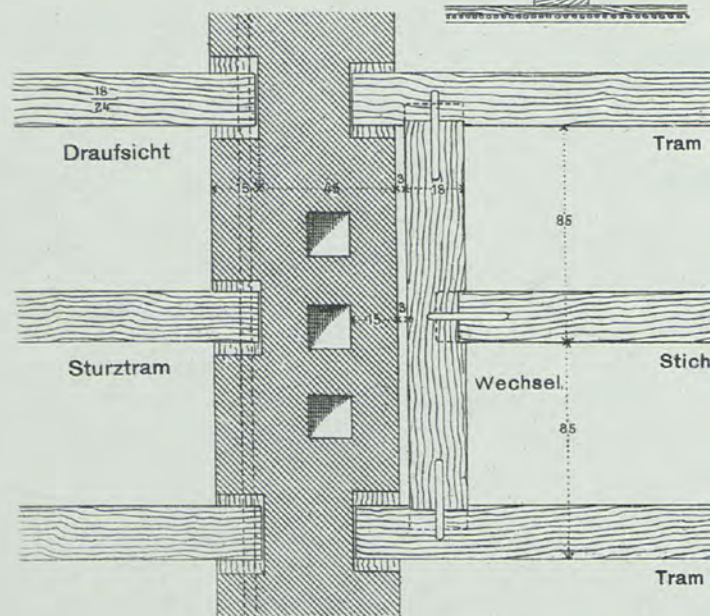
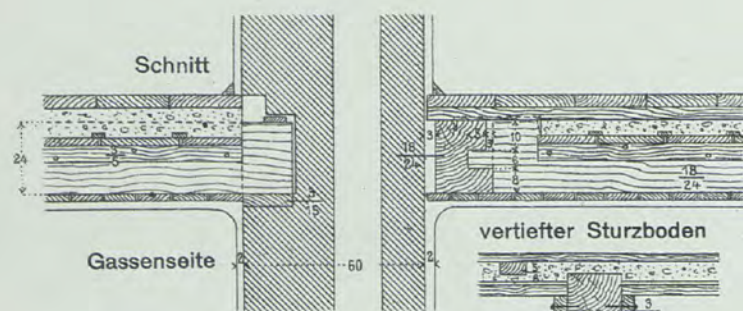
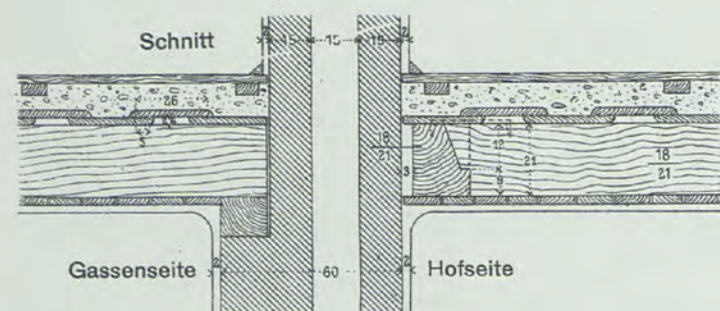
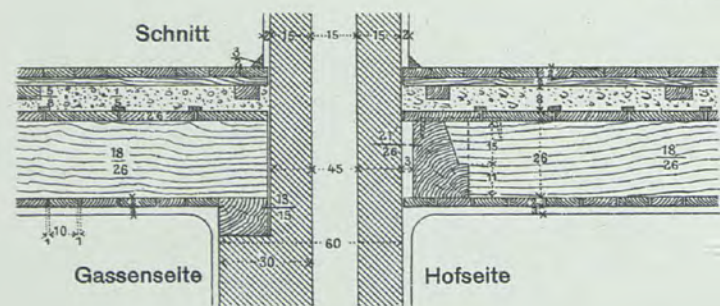

Schnitt

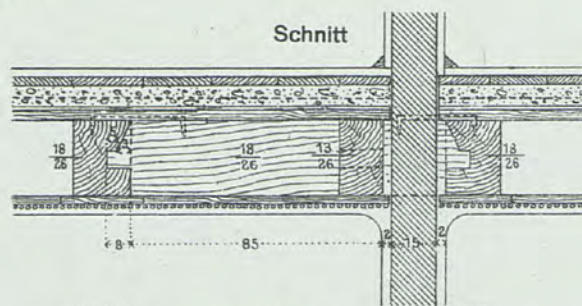

Draufsicht

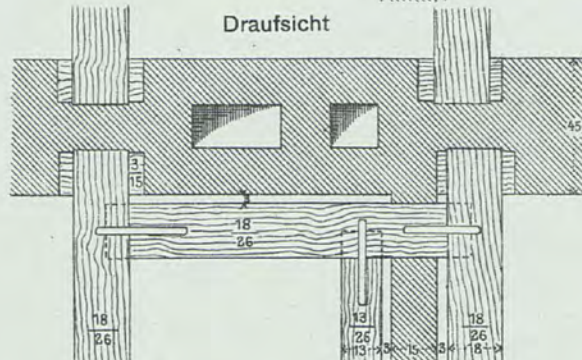

Verankerung der RastschlieÙe

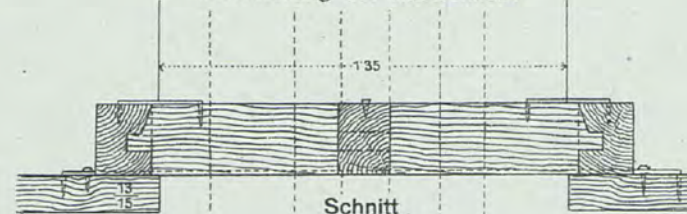

Schnitt

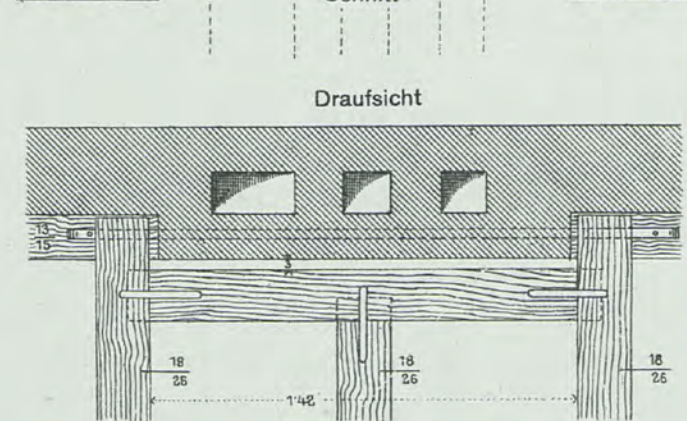

Draufsicht

Tramboden mit Kreuzverspreizung

Schnitt

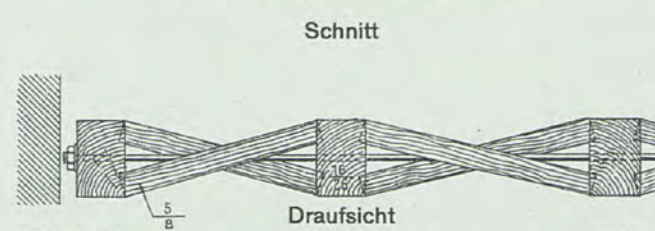

Draufsicht

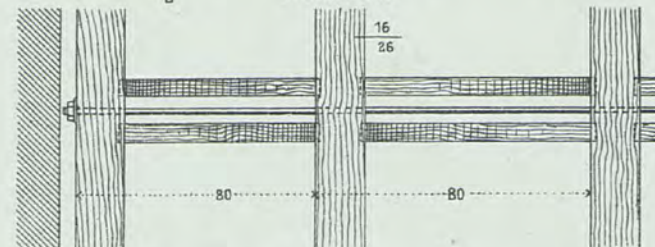

Tramboden mit Pfostenverspreizung

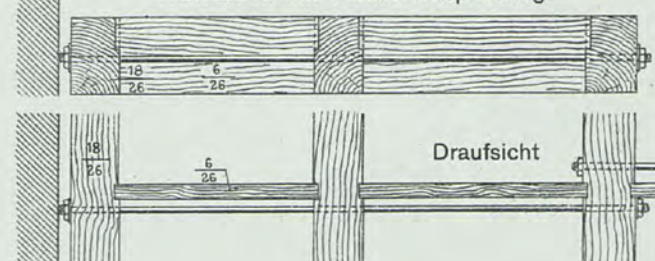

Draufsicht

Fehltramboden

Schnitt

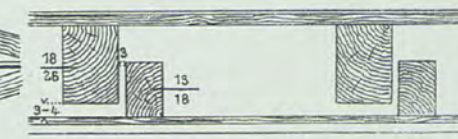

Ansicht

Schnitt

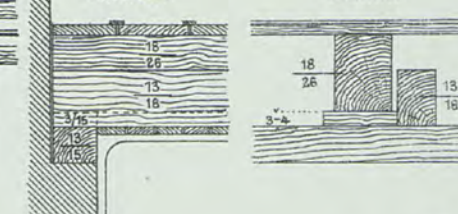

Auswechslungen

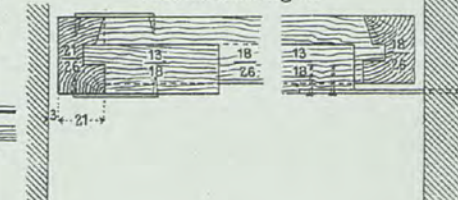

Tramboden, Unterzug, Lastholz u. eiserne Säule

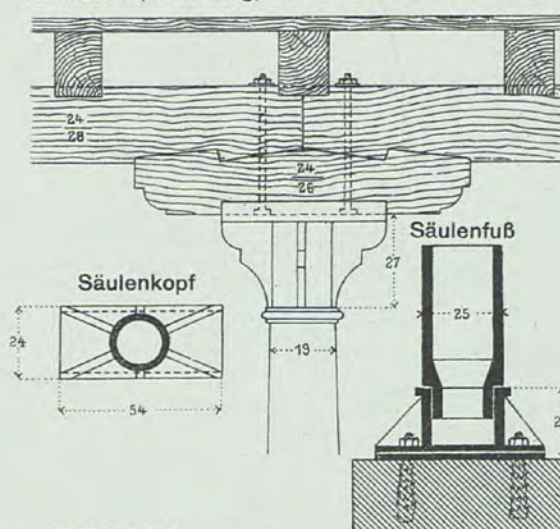

Tramboden mit Durchzug

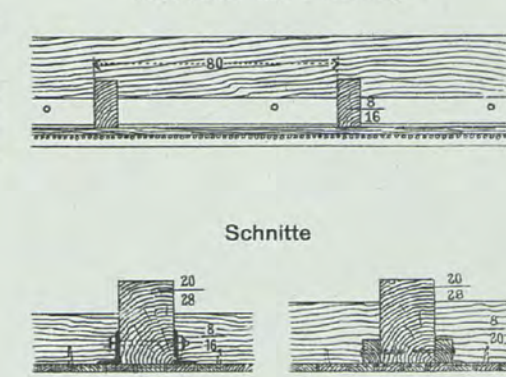

Schnitte

Ankerschließendetails

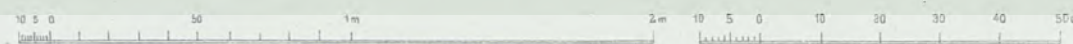
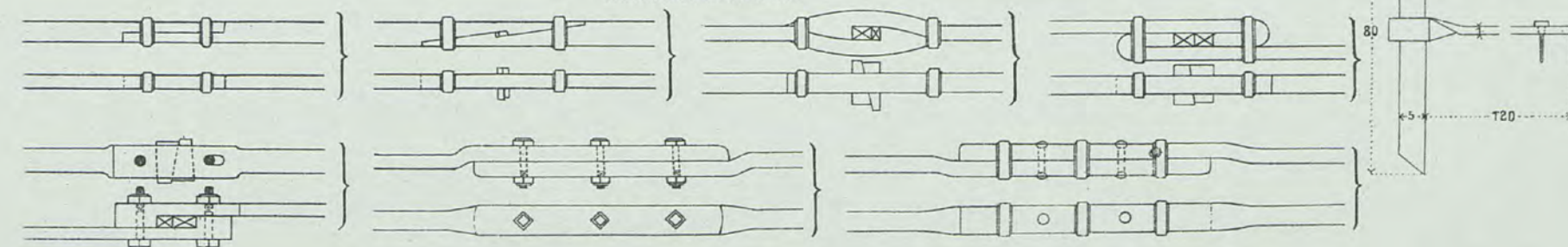

Tramboden zwischen Traversen geschnitten 1

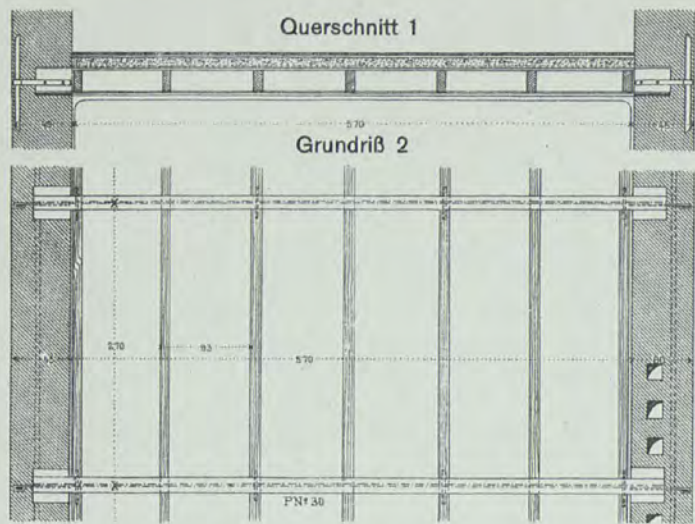

Längenschnitt 1



Doppelboden über ein Stiegenhaus 2

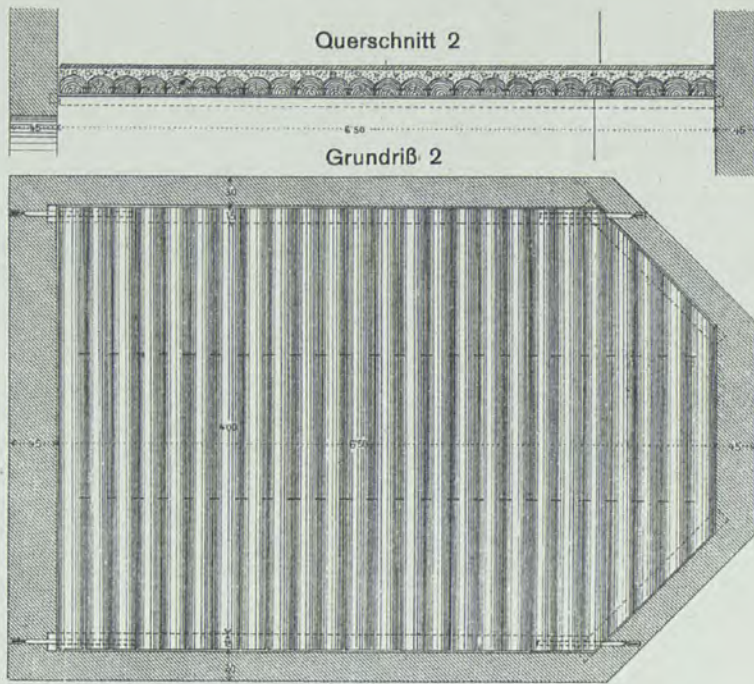

Details von Doppelboden-
auswechslungen

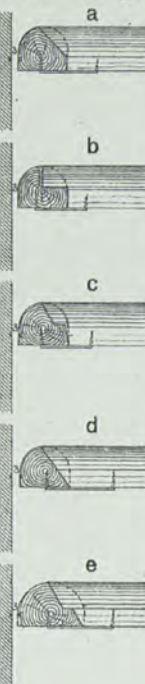

Details zum Tramboden 1



Doppelböden in der letzten Gleiche

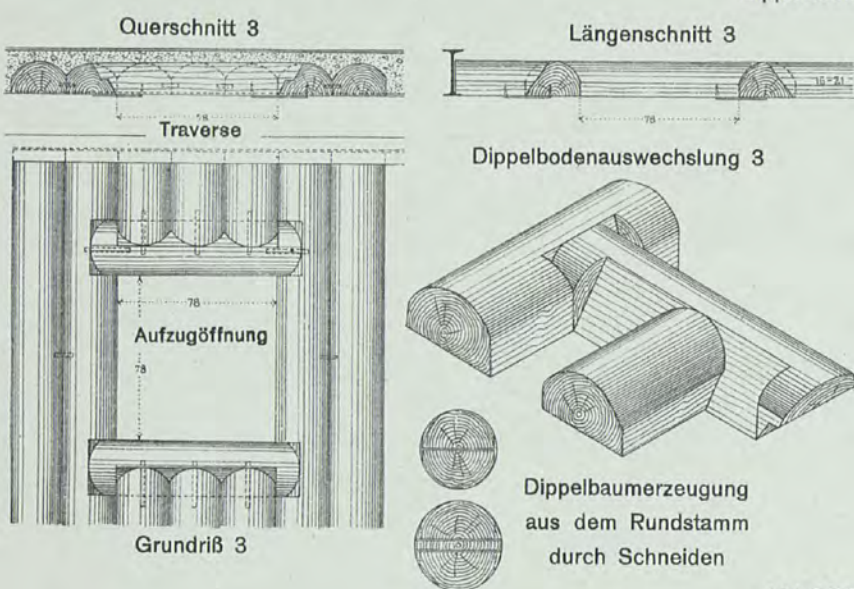

Auswechslung bei einer Rauchfanggruppe

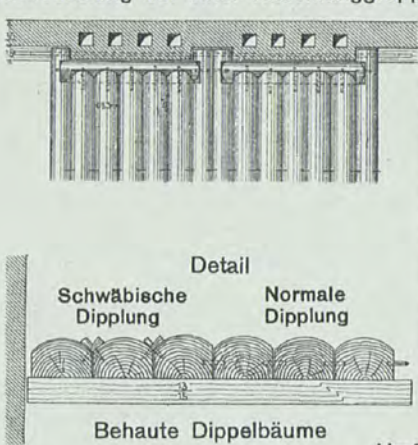

Schnitte 4

Grundriß 4

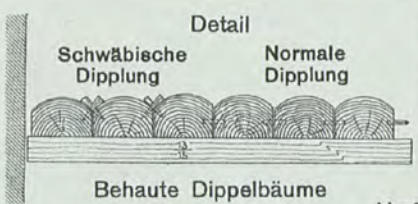

Umfassungsmauer

Mittelmauer mit
Rauchfanganlage

KASSETTENDECKEN

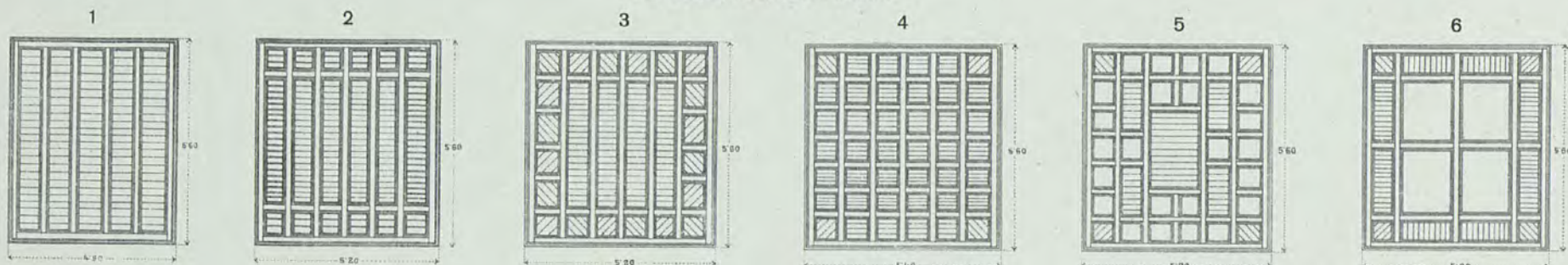

Tramdetaills

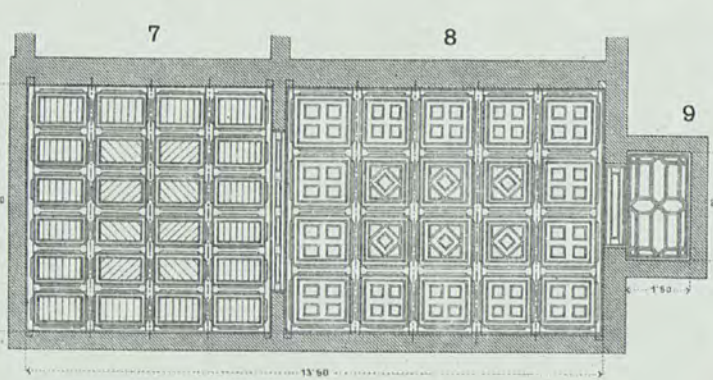
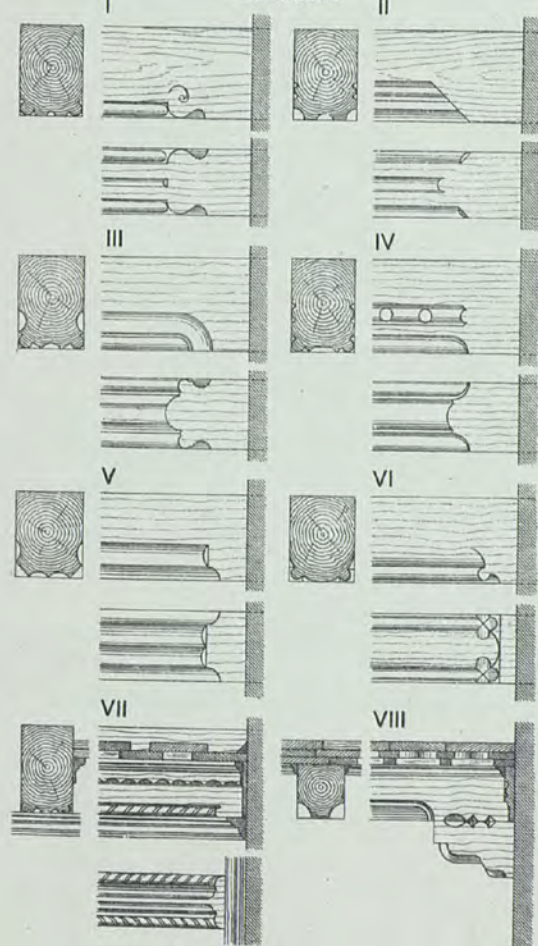

Details der verkleideten Tramedecken 1 bis 6

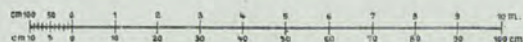
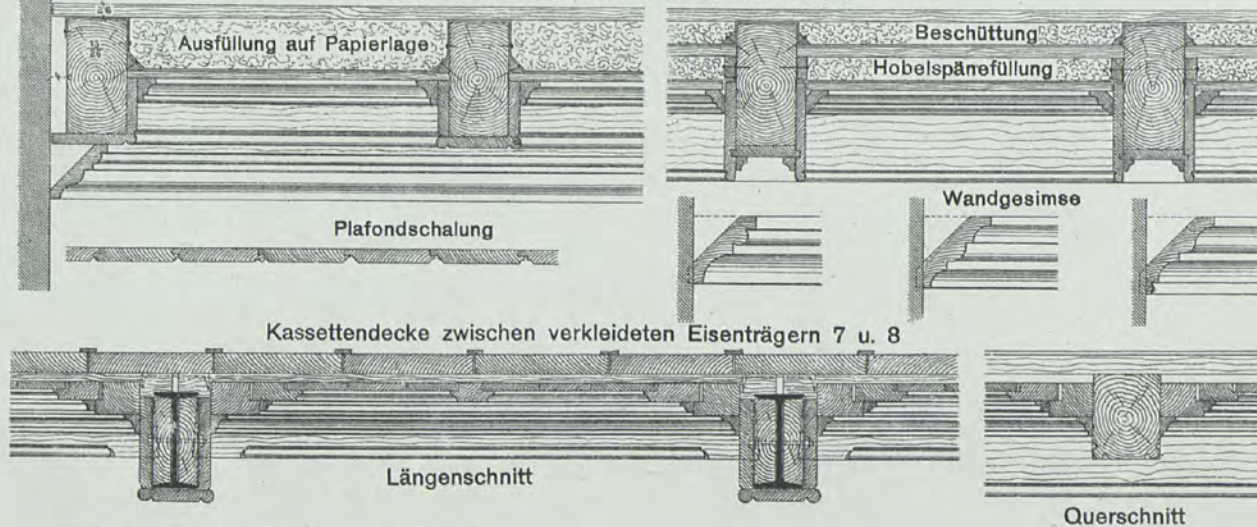

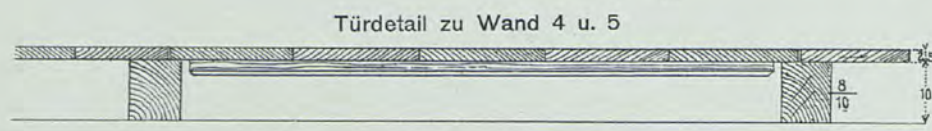
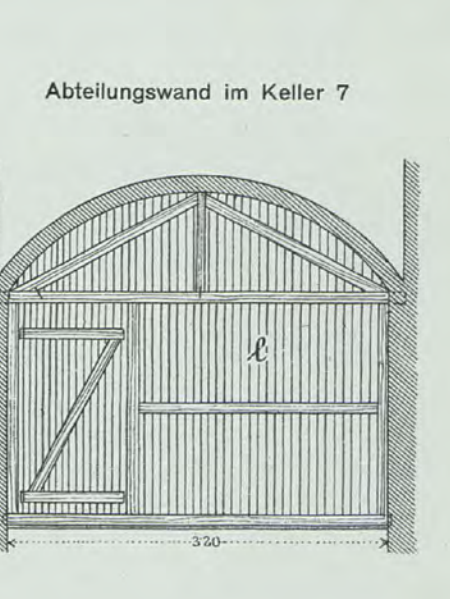
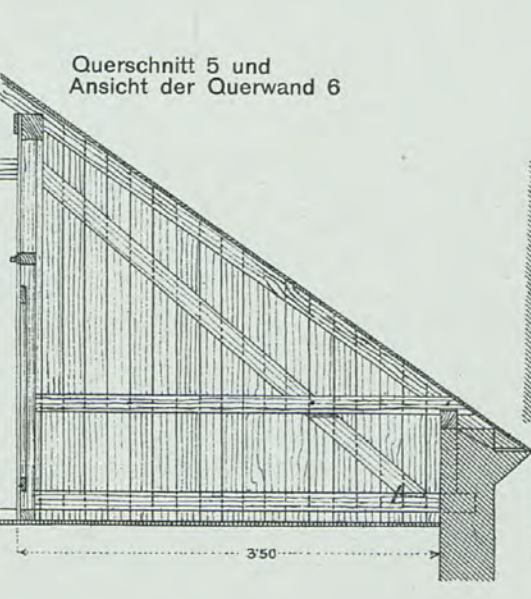
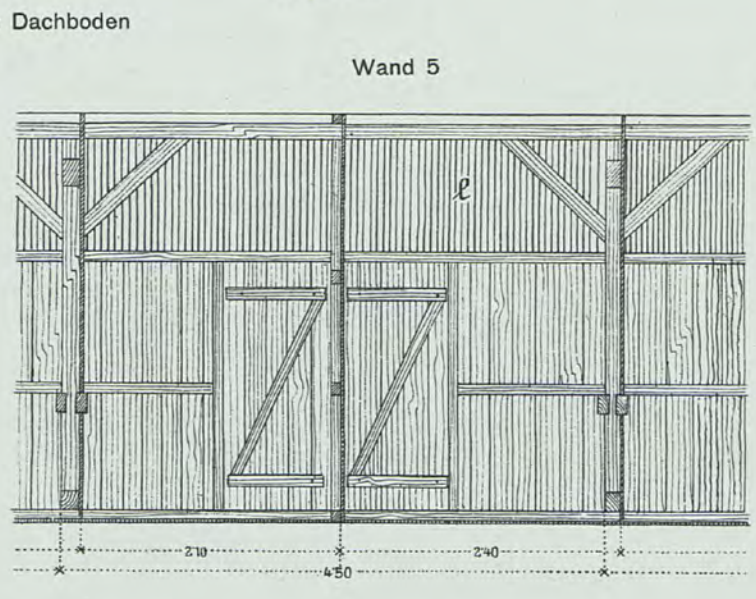
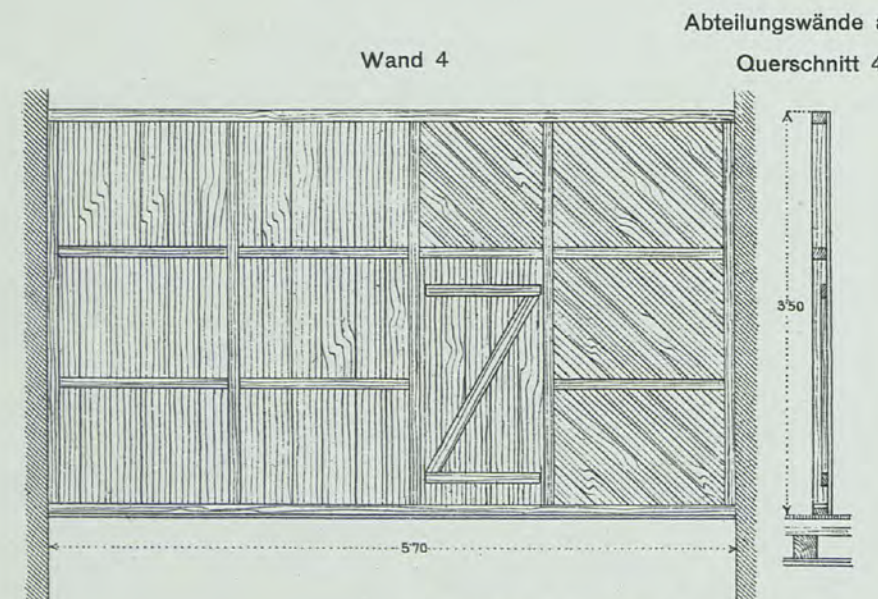
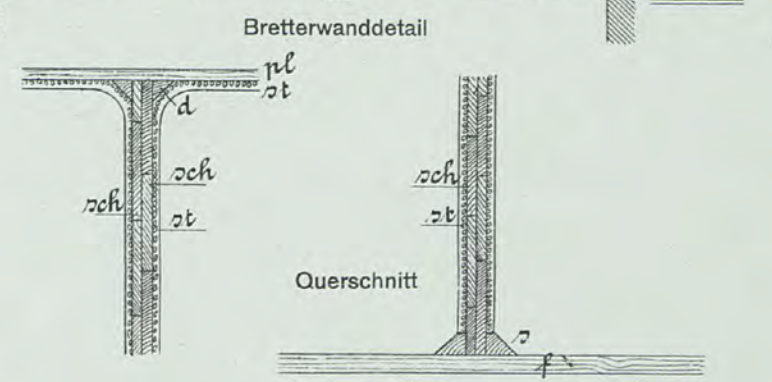
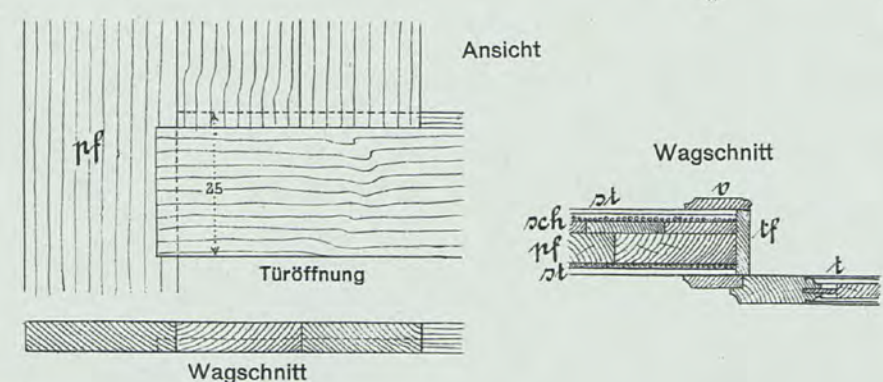
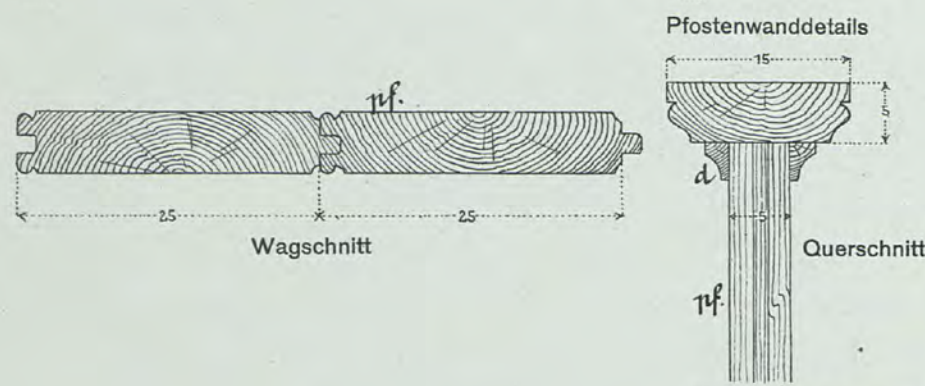
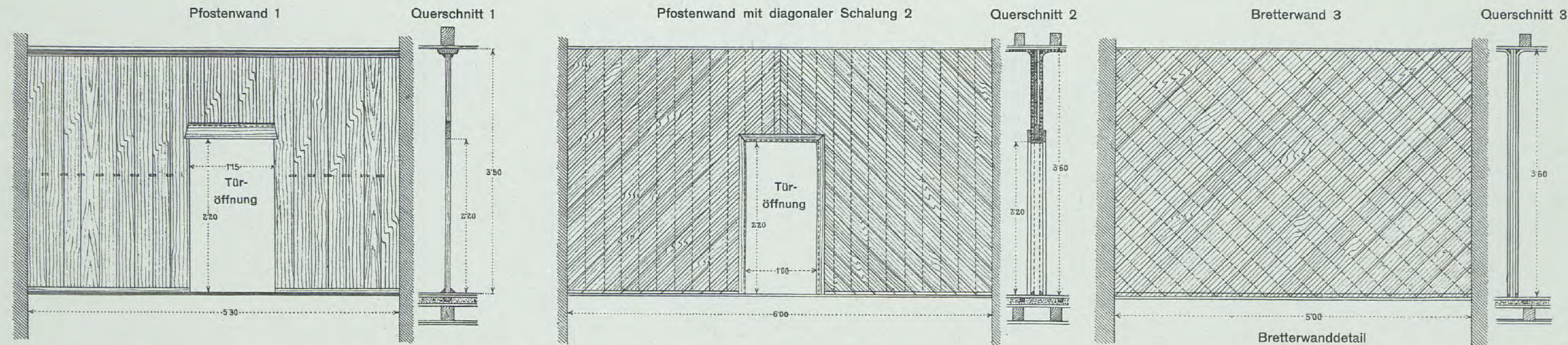

- Bezeichnungen:
- sch = Schalung
 - pf = Pfosten
 - st = Stukkaturung
 - t = Tür
 - tf = Türfutter
 - v = Türverkleidung
 - pl = Plafondschalung
 - d = Dreieckleiste
 - s = Sesselleiste
 - f = Fußboden
 - l = Latten

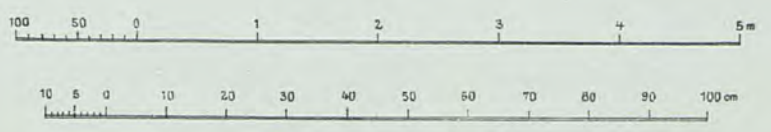

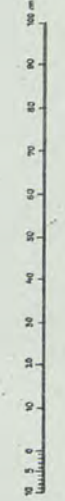
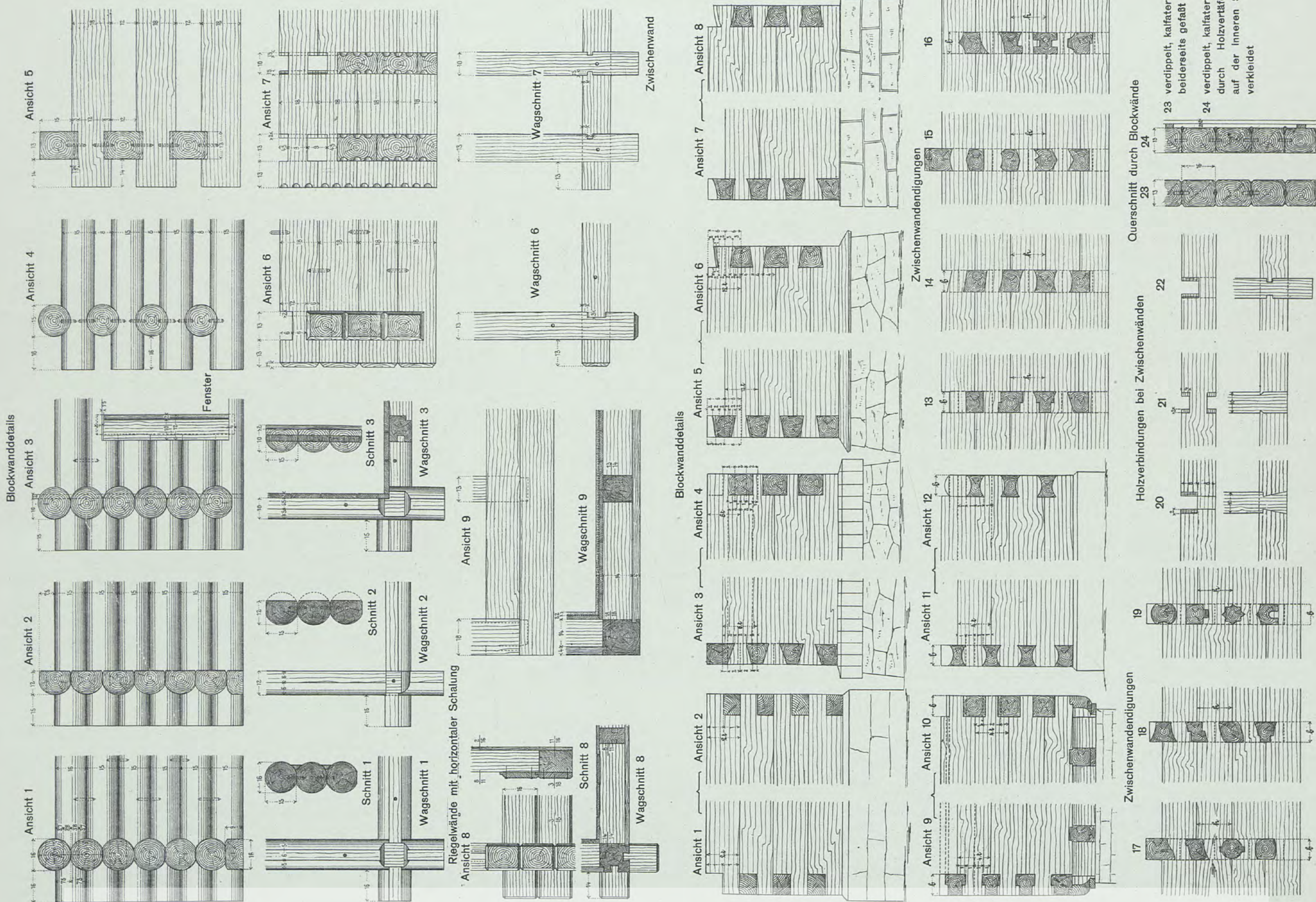

I. Giebelansicht

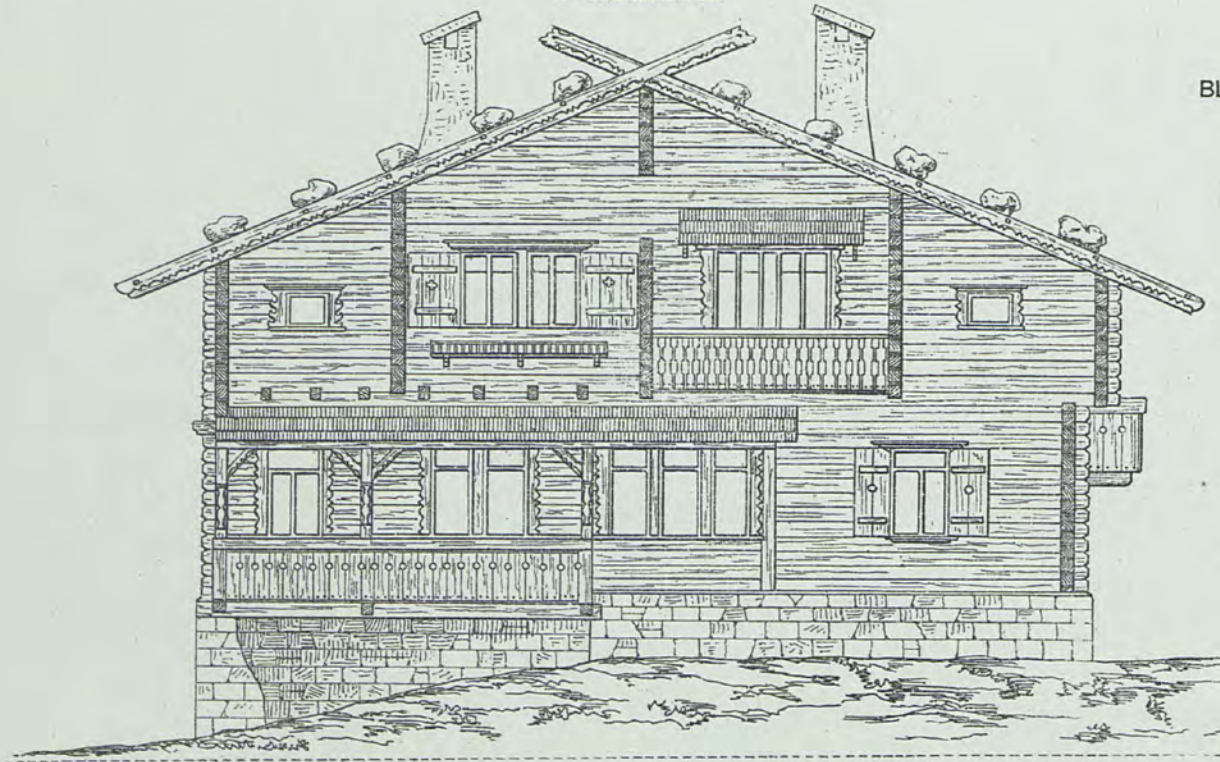

BLOCKWANDBAU

II. Giebelansicht

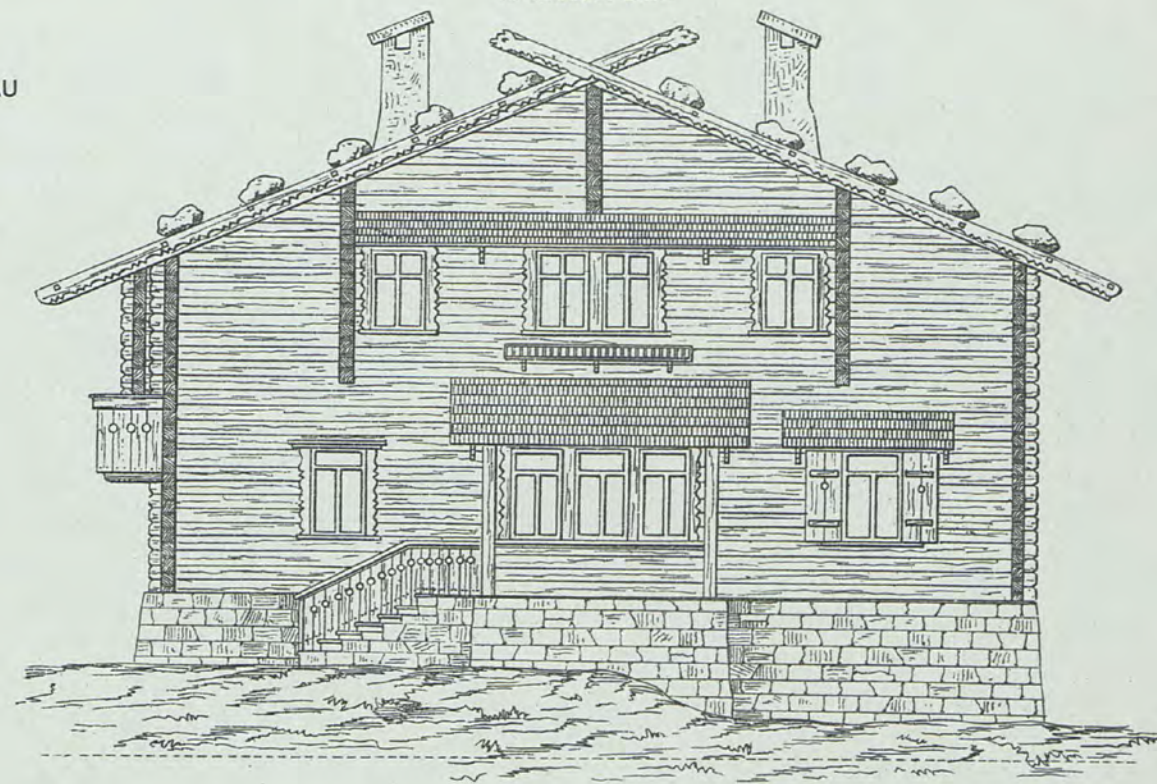

I. Seitenansicht



II. Seitenansicht

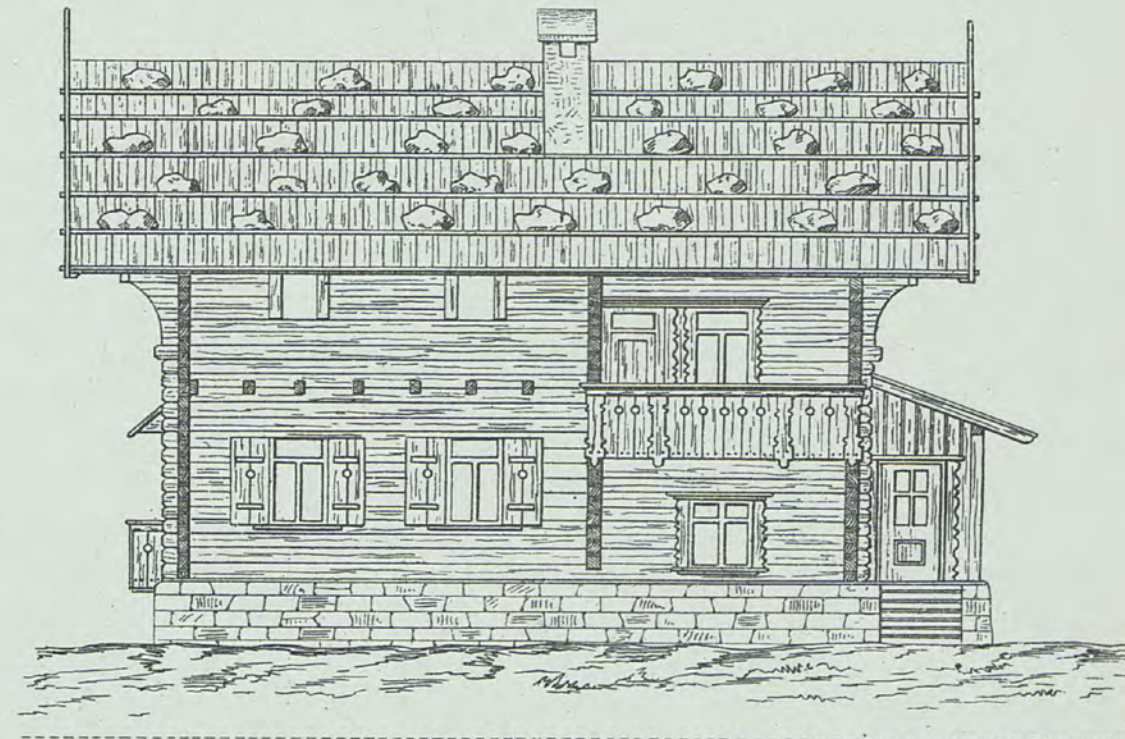

Innere Riegelwände, direkt auf dem Sturztram stehend

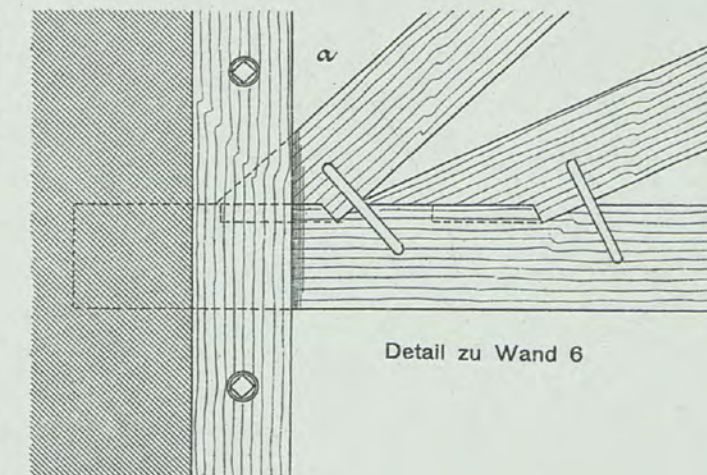
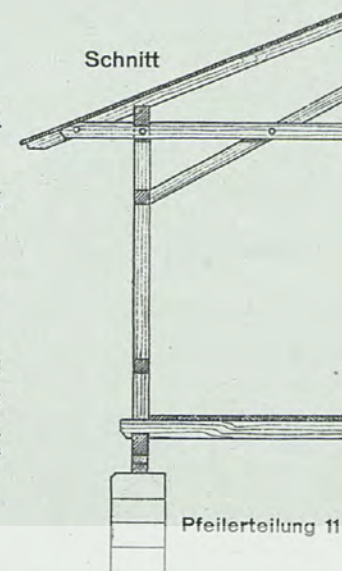
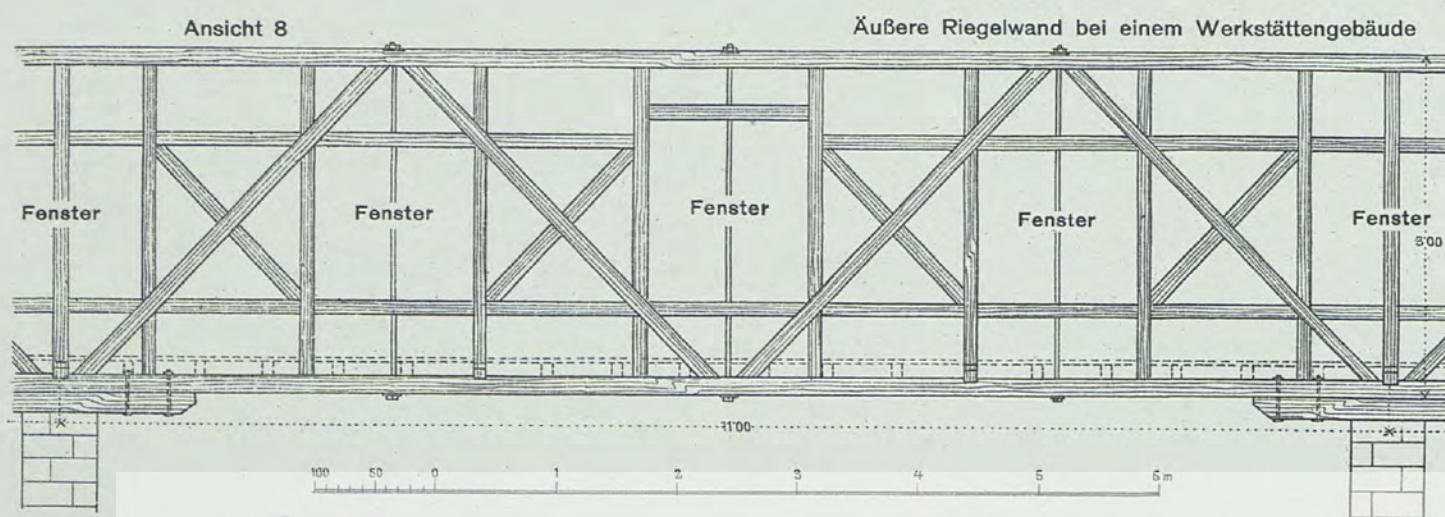
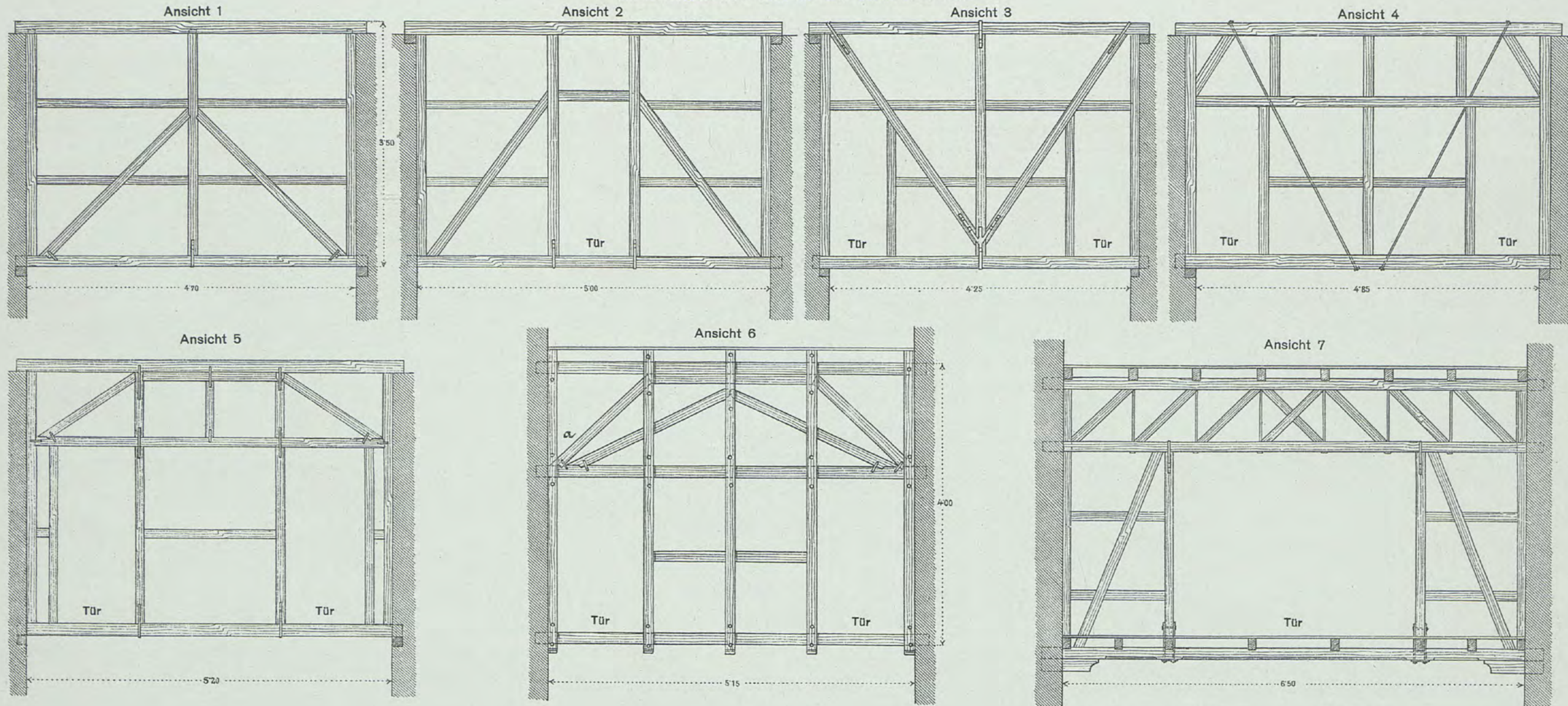

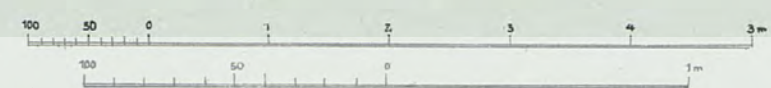
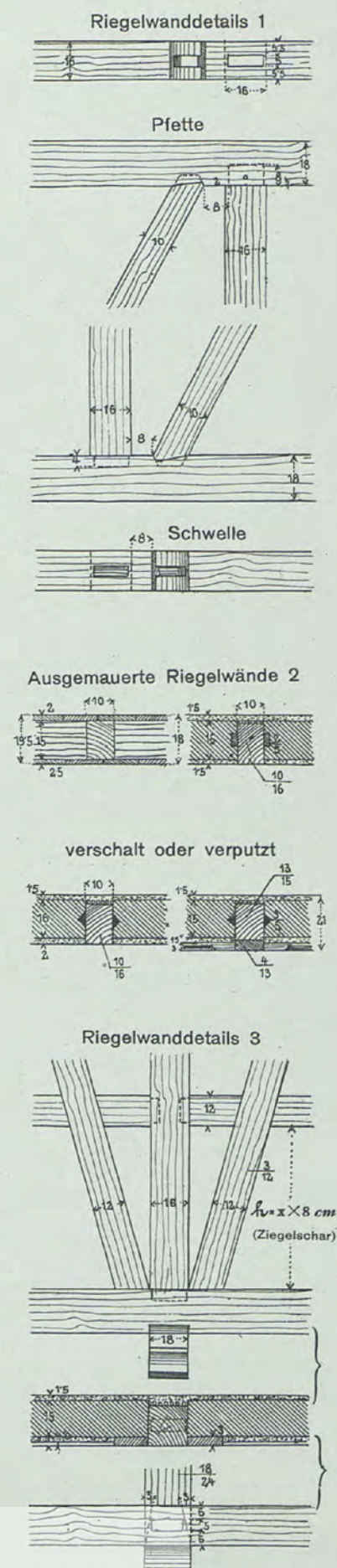
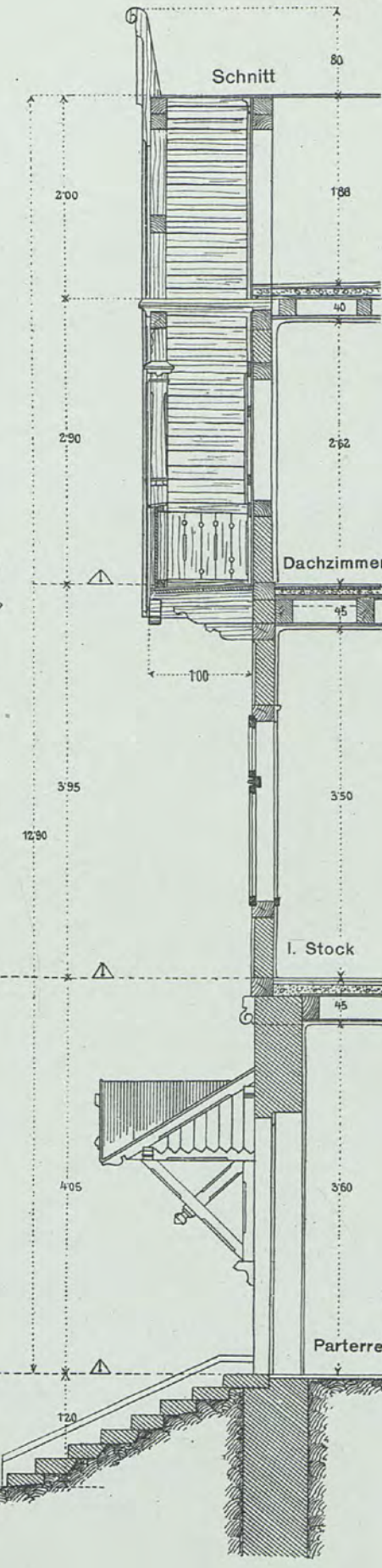
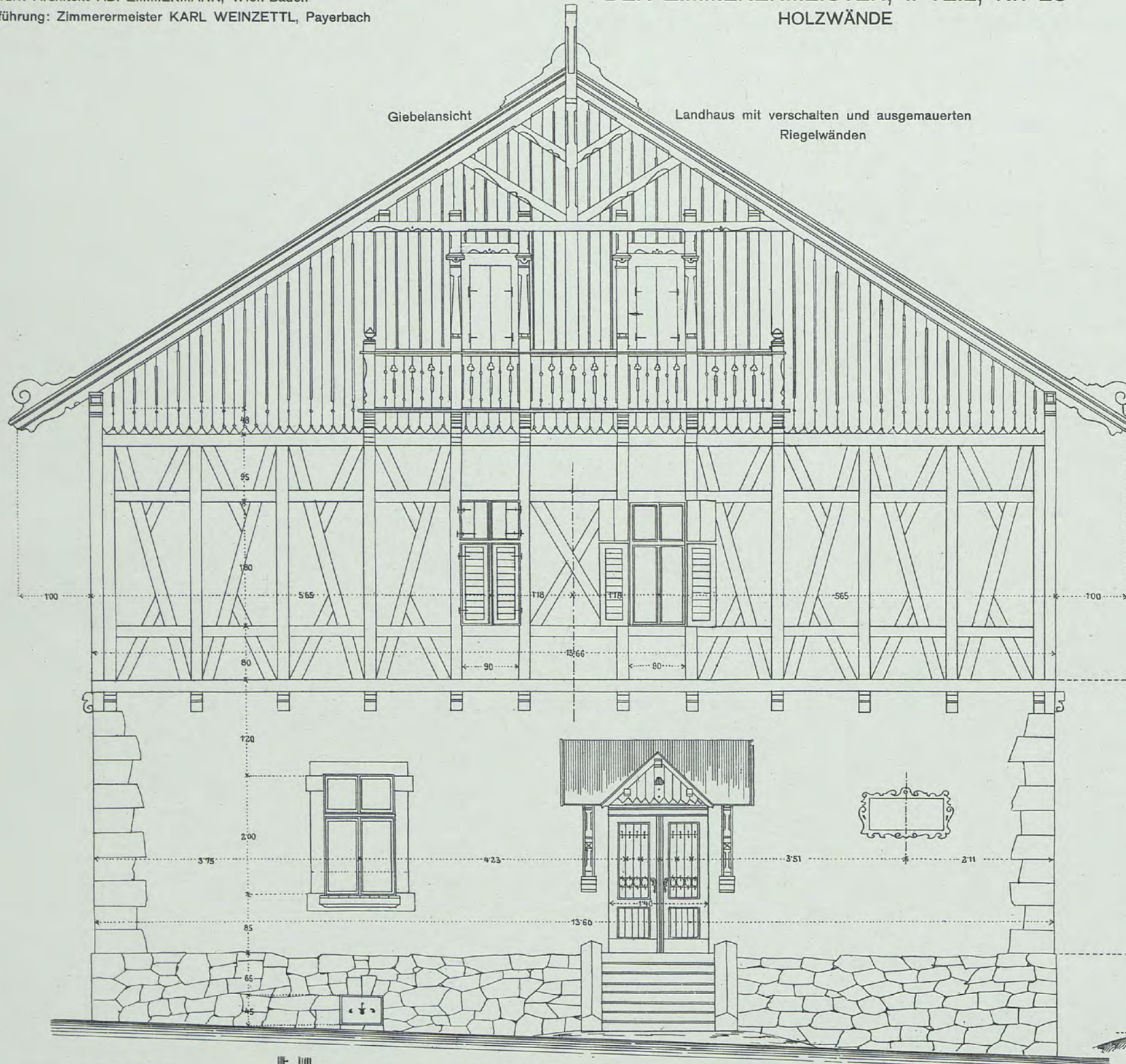

Planken

Geschweifte Plankenbretter

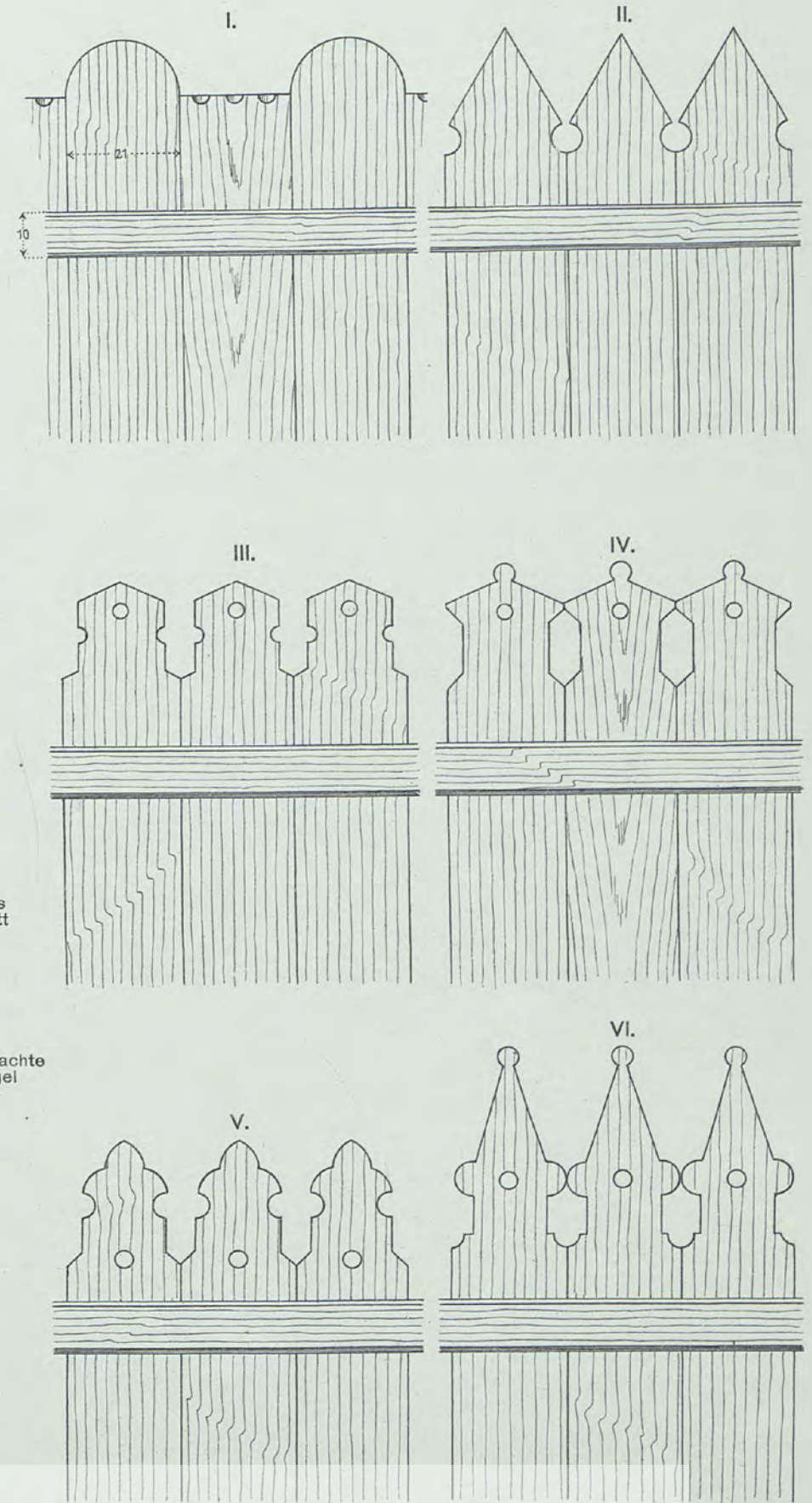
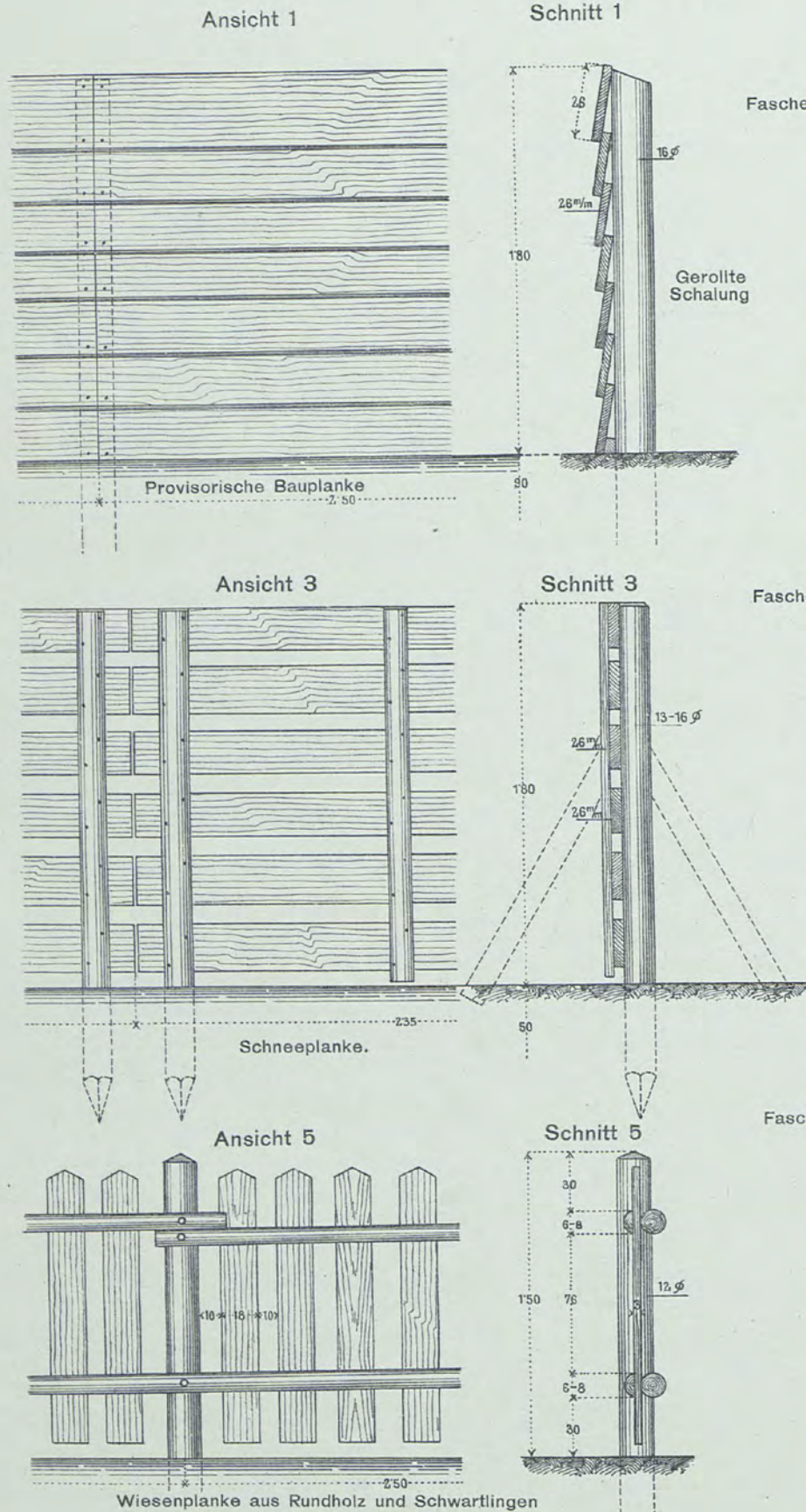

Die hölzernen Faschen können durch Bandisen ersetzt werden

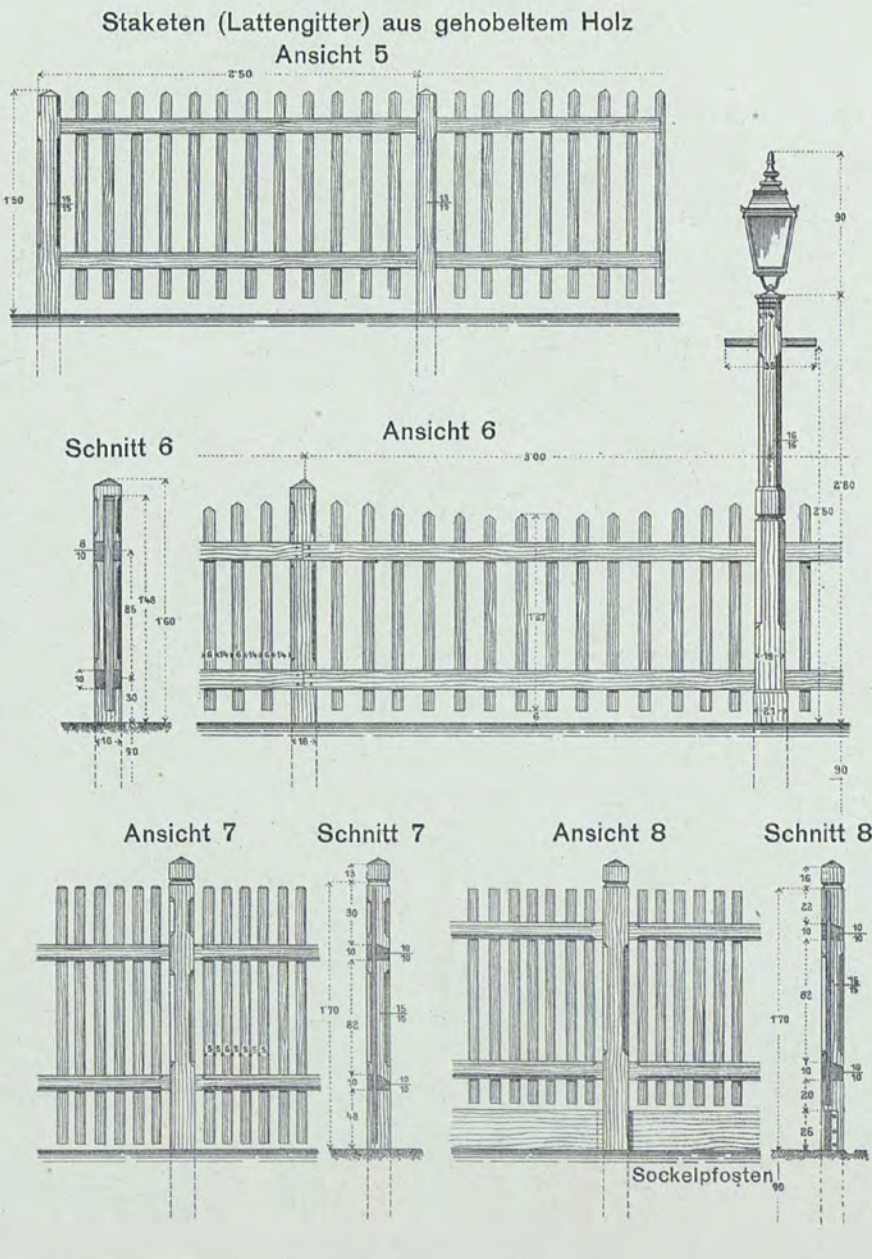
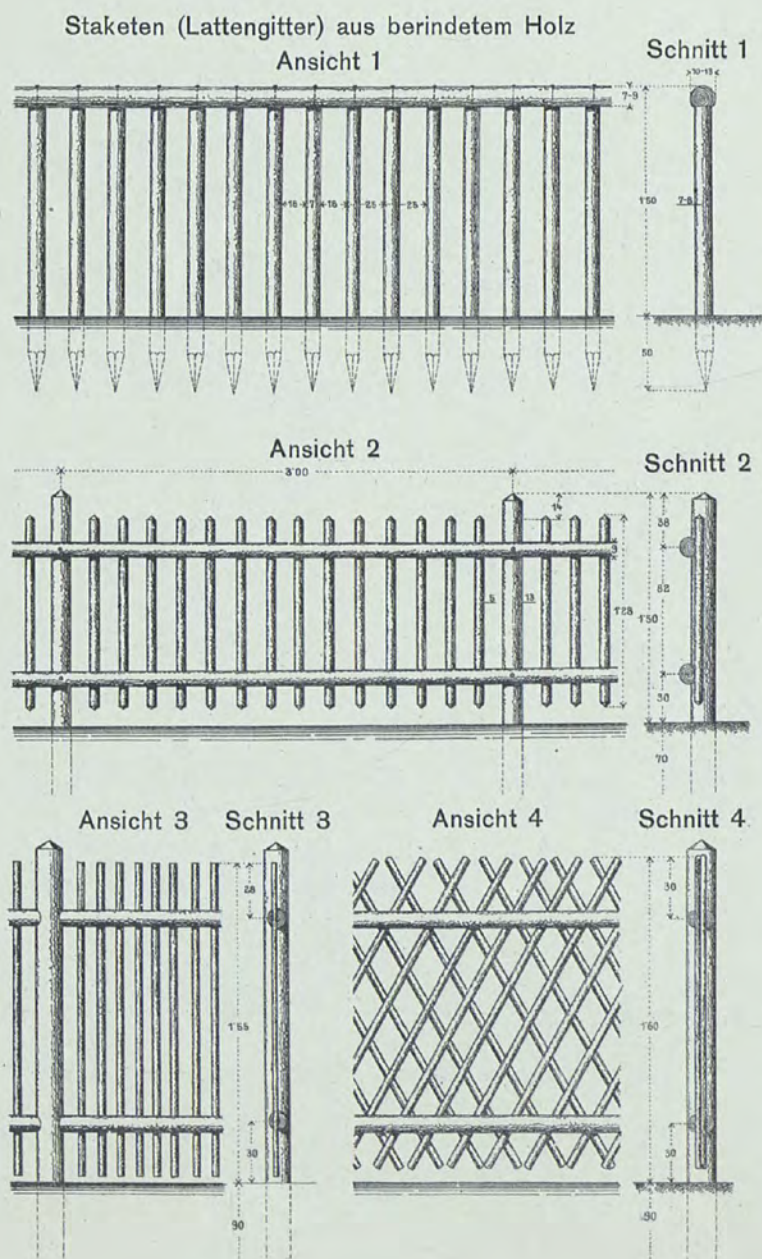
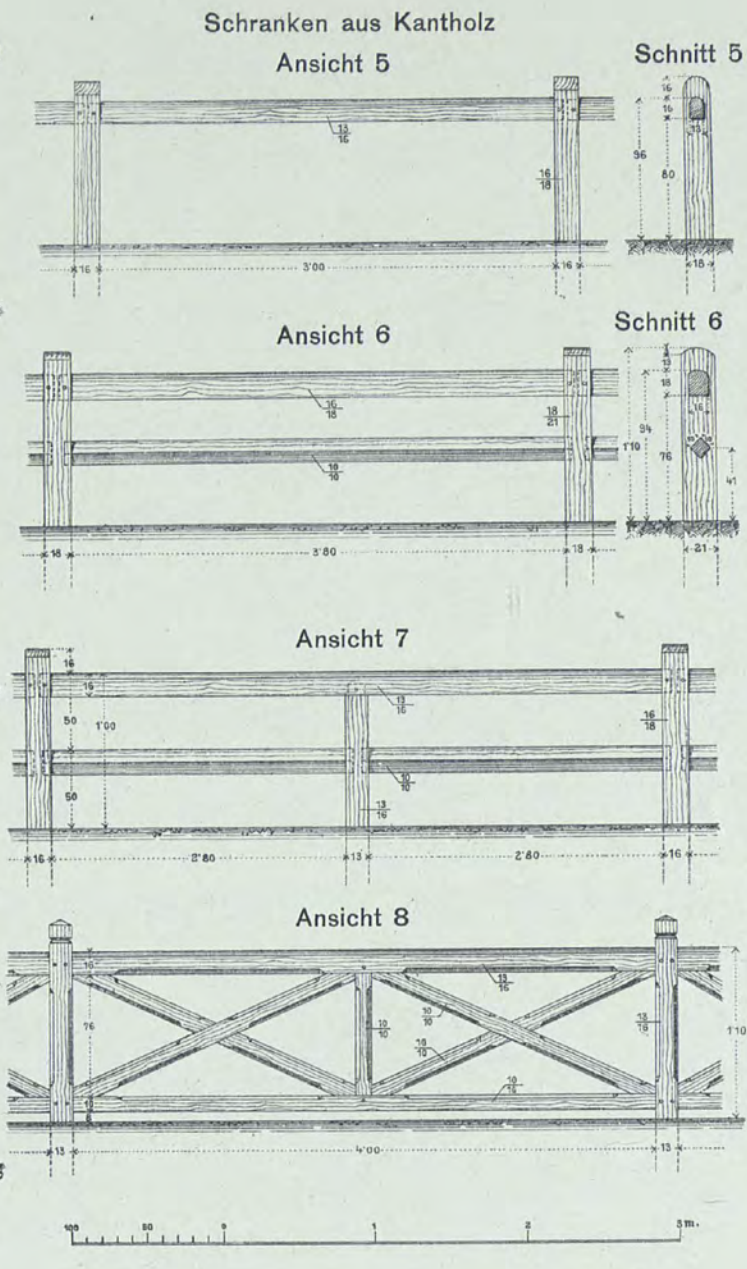
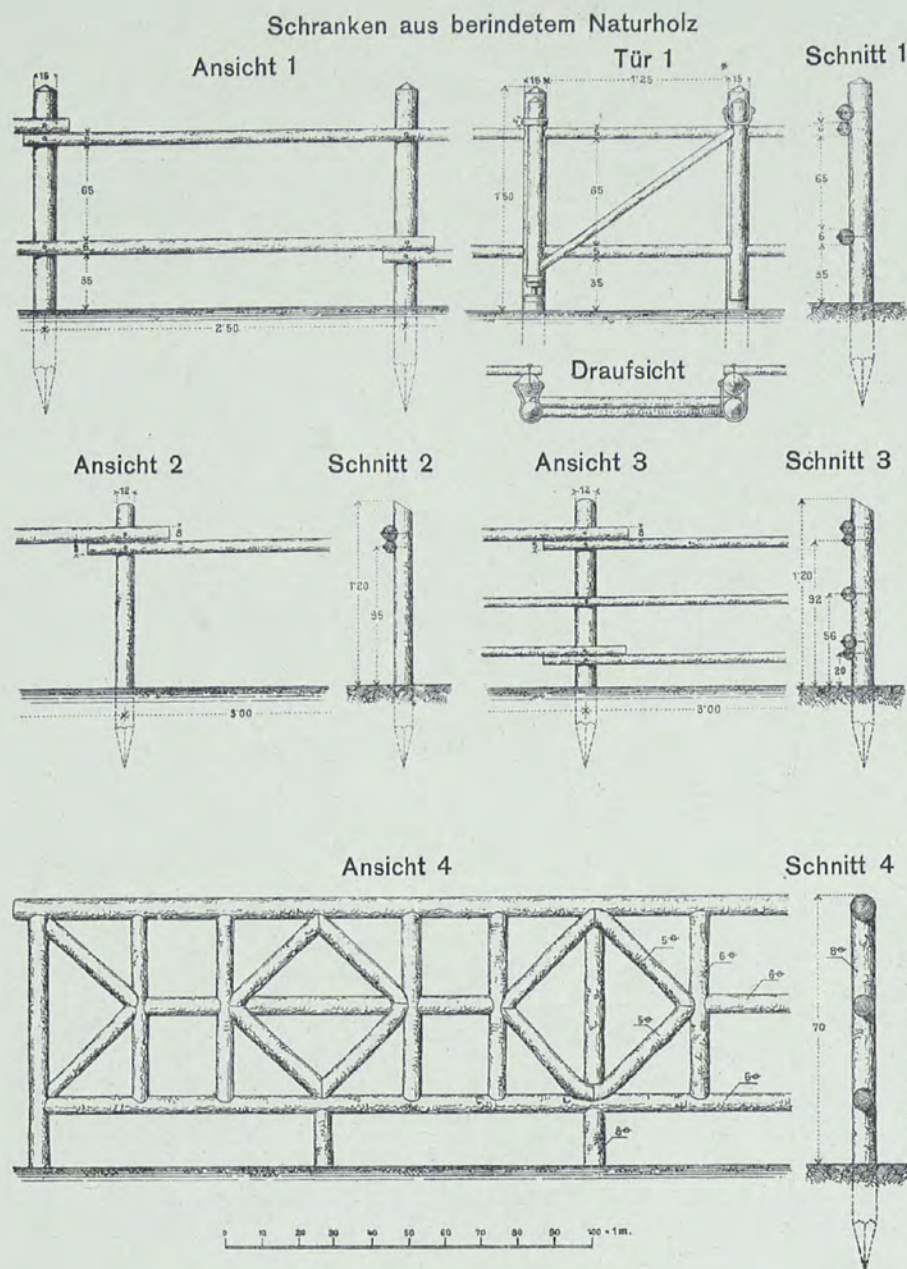

Mit normaler Belastung und normaler Holzstärke
tragen sich die Träme bis 6 m lichte Länge frei

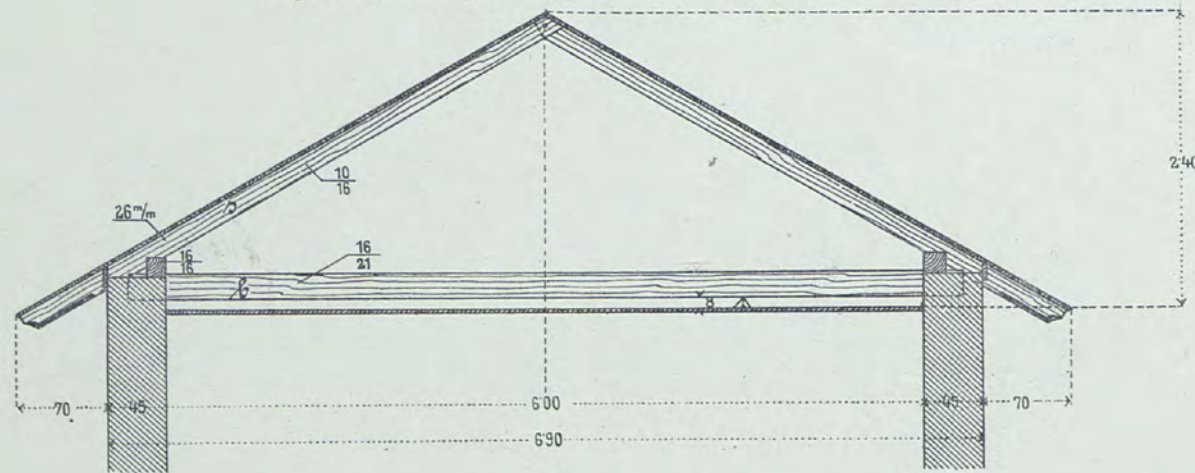

Einfaches Hängewerk bei einem Dachstuhl

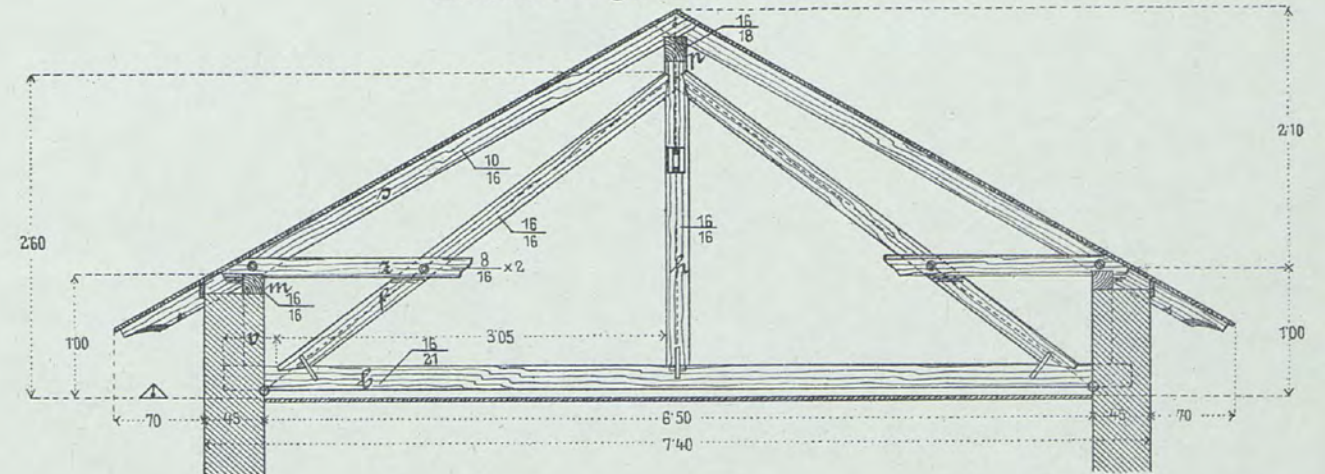

Einfaches Hängewerk mit Tramboden bei einem Dachstuhl

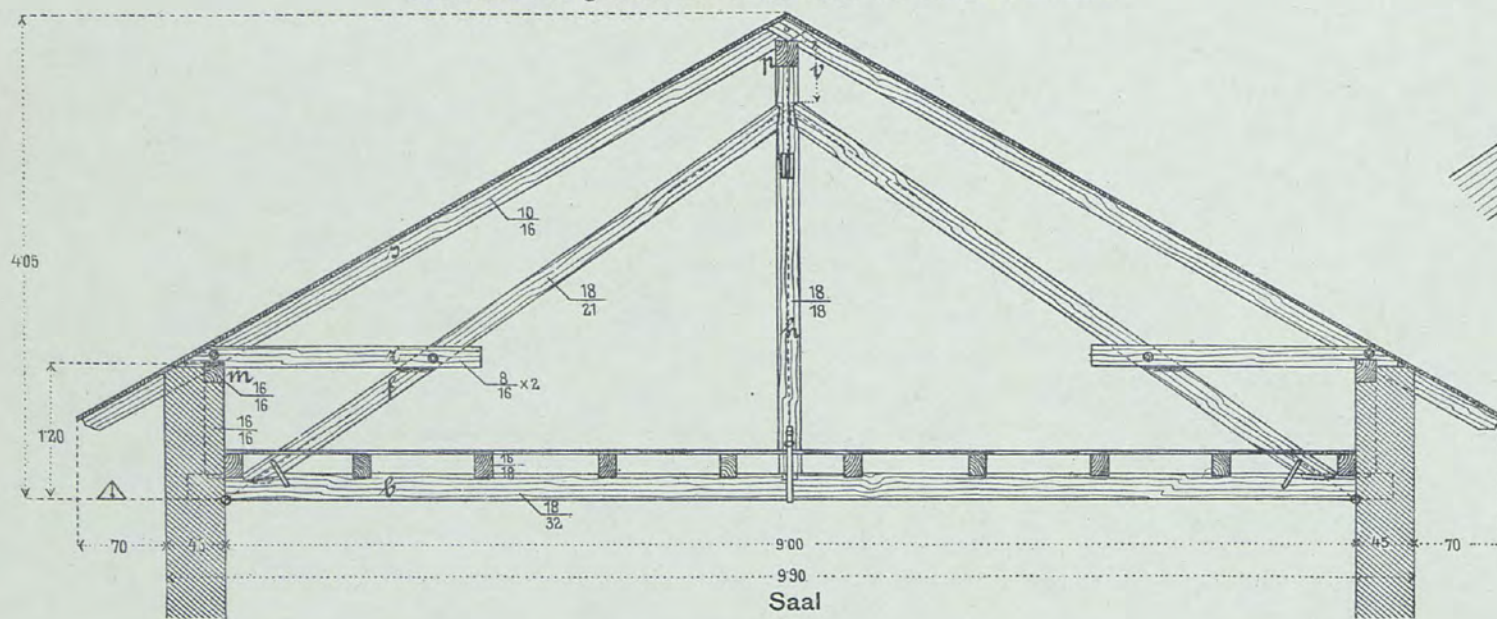

Details

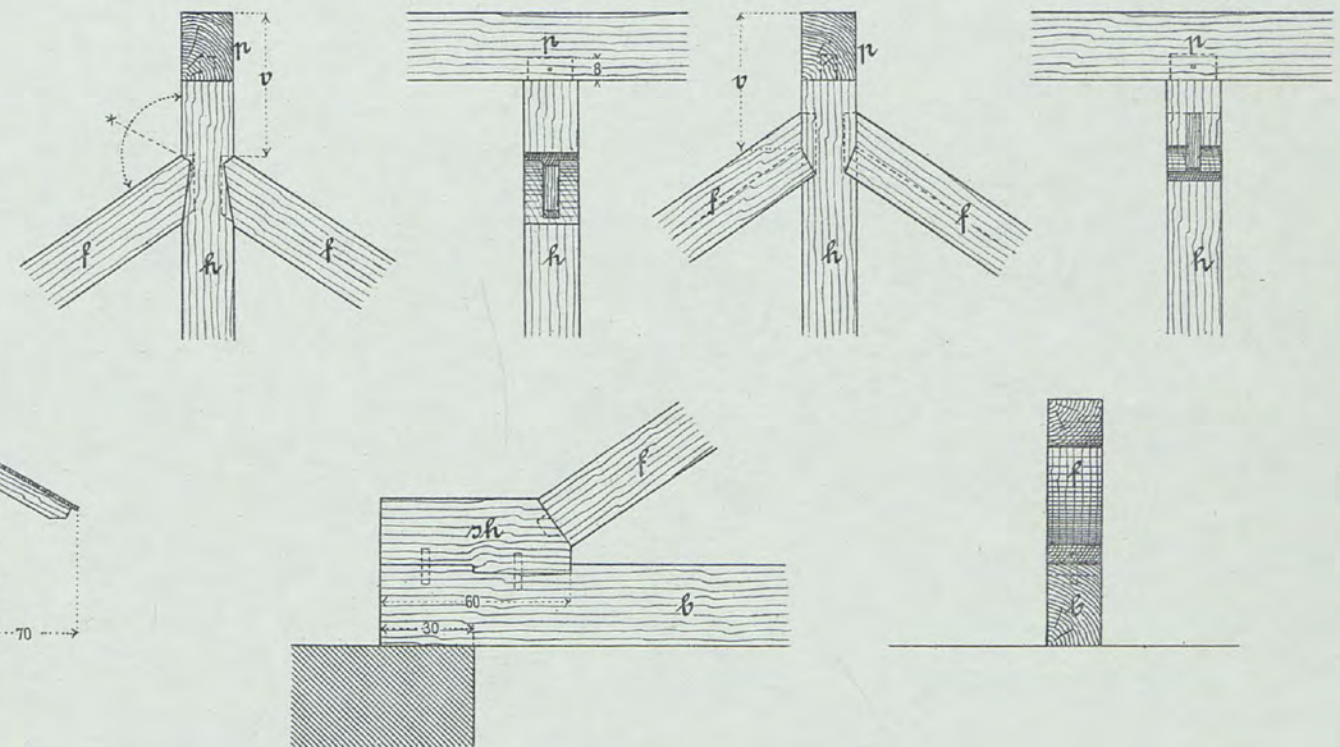

Details

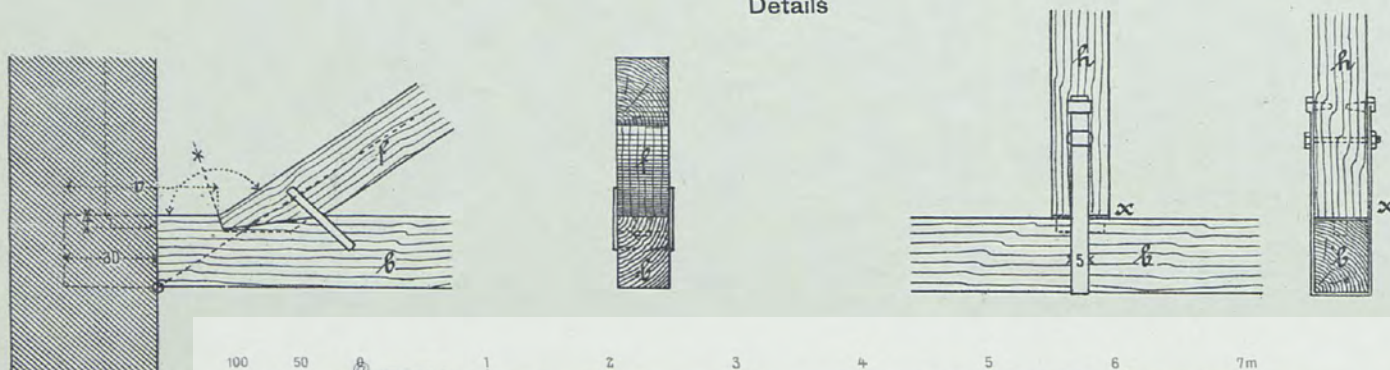

Kräftezerlegung

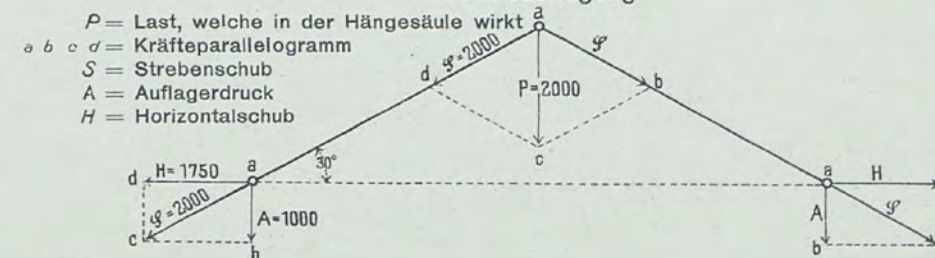

Bezeichnungen:

- b = Bundtram
- f = Fußband
- hs = Hängesäule
- sh = Sattelholz
- m = Mauerbank (Fußpfette)
- p = Pfette (Firstpfette)
- z = Zange
- v = Vorkopf
- s = Sparren
- △ = Wagriß
- x = Verkürzung der Säule um 2 cm beim Abbinden zur Sprengung des Bundtrames

100 50 0 1 2 3 4 5 6 7m

100 50 0 1m



Doppeltes Hängewerk mit Tramboden bei einem Dachstuhl

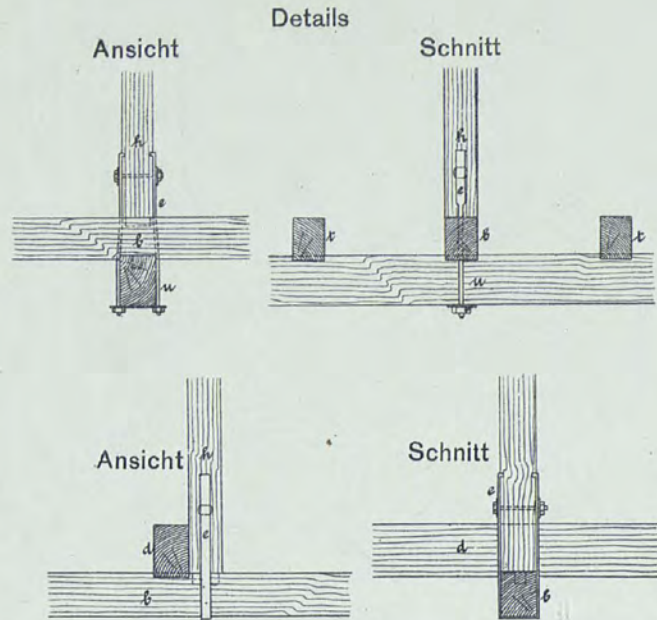
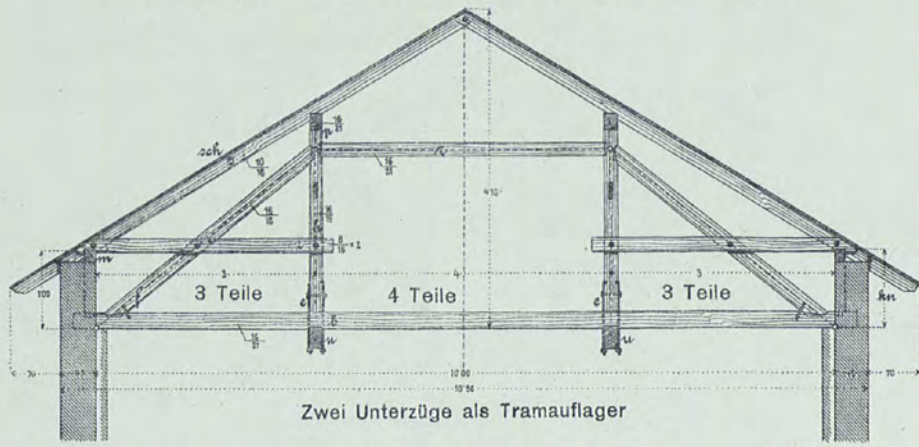

Doppeltes Hängewerk mit Tramboden bei einem Dachstuhl

Kräftezerlegung:
P = Last, welche in der Hängesäule wirkt
I, II, III, IV = Kräfteparallelogramm
S = Strebenschub
H = Horizontalschub
A = Auflagerdruck

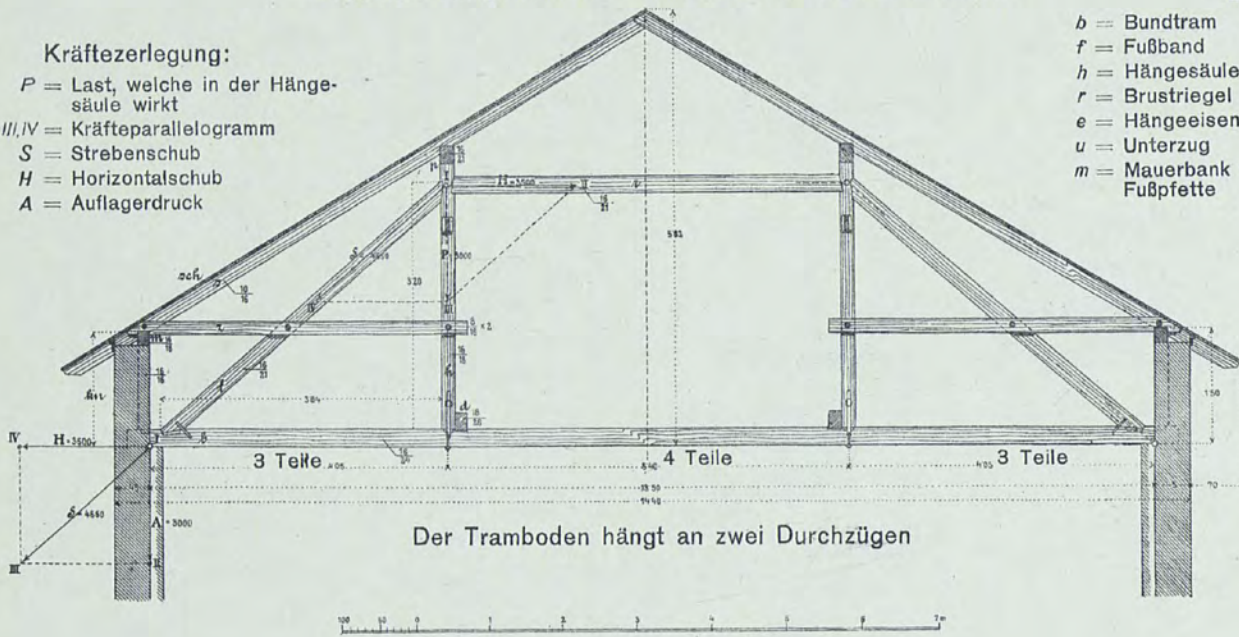

Bezeichnungen:

- | | |
|-------------------------------------|---------------------------|
| <i>b</i> = Bundtram | <i>p</i> = Stuhlfette |
| <i>f</i> = Fußband | <i>z</i> = Zange |
| <i>h</i> = Hängesäule | <i>s</i> = Sparren |
| <i>r</i> = Brustriegel | <i>t</i> = Tramboden |
| <i>e</i> = Hängeeisen | <i>d</i> = Durchzug |
| <i>u</i> = Unterzug | <i>sch</i> = Dachschalung |
| <i>m</i> = Mauerbank oder Fußpfette | <i>kn</i> = Kniestock |

Knotenpunkt

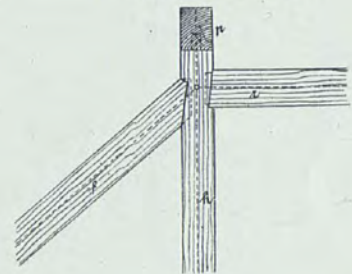

Dreifaches Hängewerk bei einem Dachstuhl

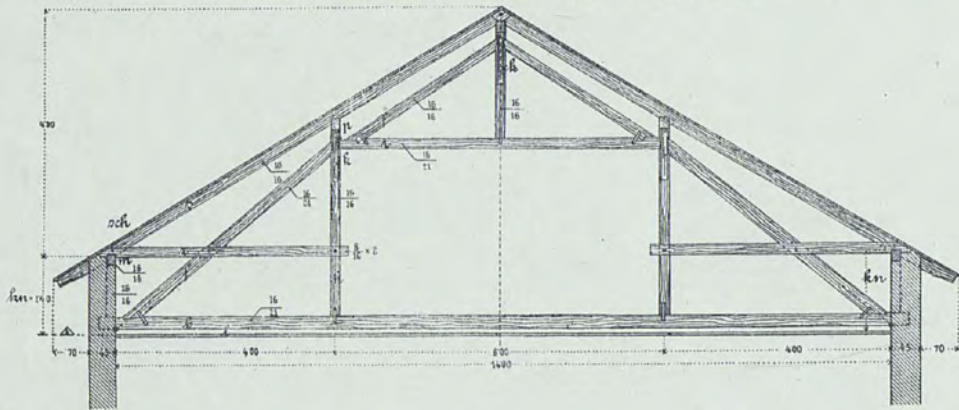

Details

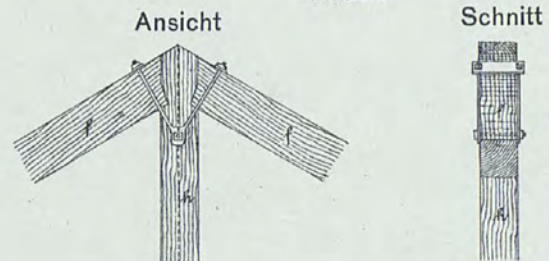

Bezeichnungen:

- | |
|--------------------------------------|
| <i>b</i> = Bundtram |
| <i>f</i> = Fußband |
| <i>h</i> = Hängesäule |
| <i>zh</i> = Zangenhängesäule |
| <i>r</i> = Brustriegel |
| <i>m</i> = Mauerbank |
| <i>p</i> = Pfette |
| <i>z</i> = Zange |
| <i>k</i> = Kopfband |
| <i>s</i> = Sparren |
| <i>sch</i> = Dachschalung |
| <i>l</i> = Lehmschlag, Bodenpflaster |
| <i>pf</i> = Pfostenboden |
| <i>t</i> = Tramboden |
| <i>e</i> = Hängeeisen |
| <i>kn</i> = Kniestock |

Dreifaches Hängewerk mit Tramboden

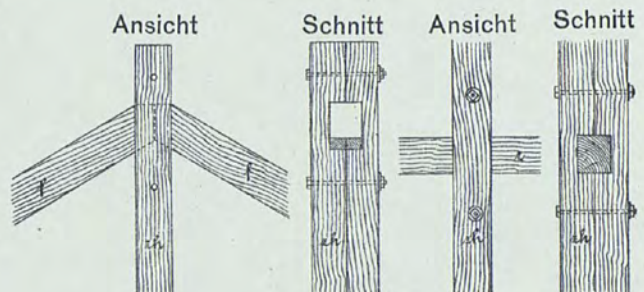
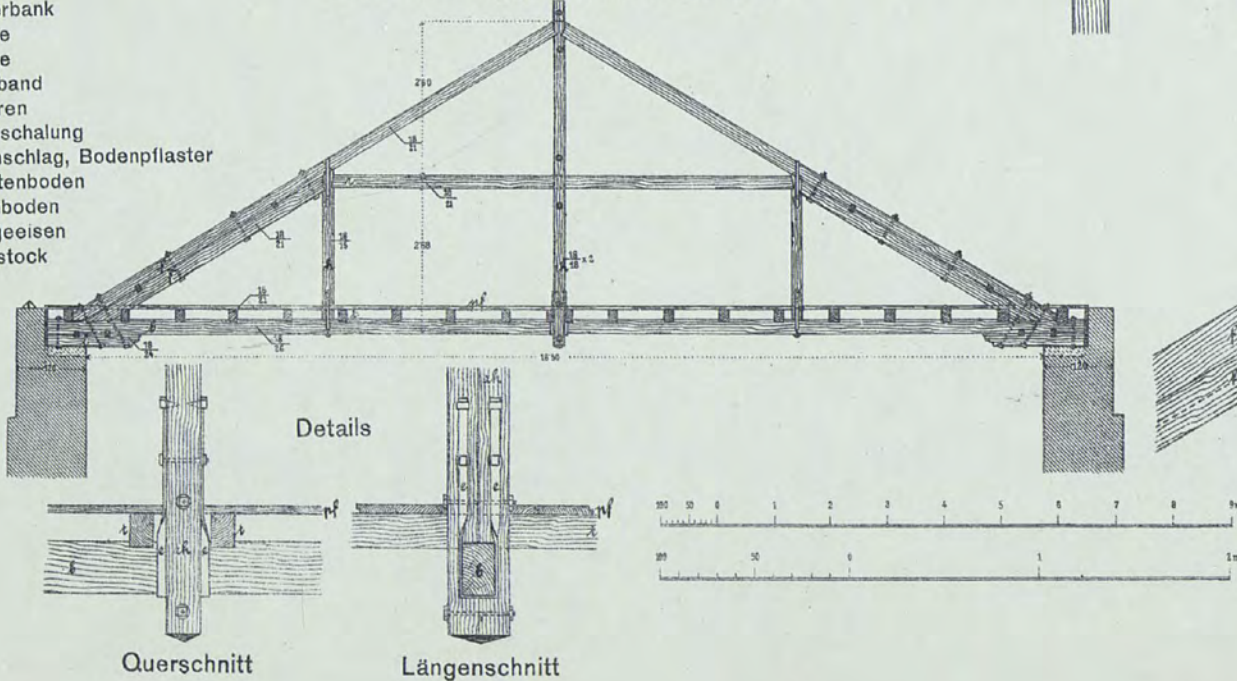

Ansicht

Schnitt

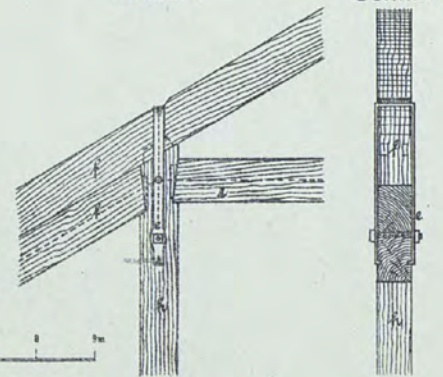

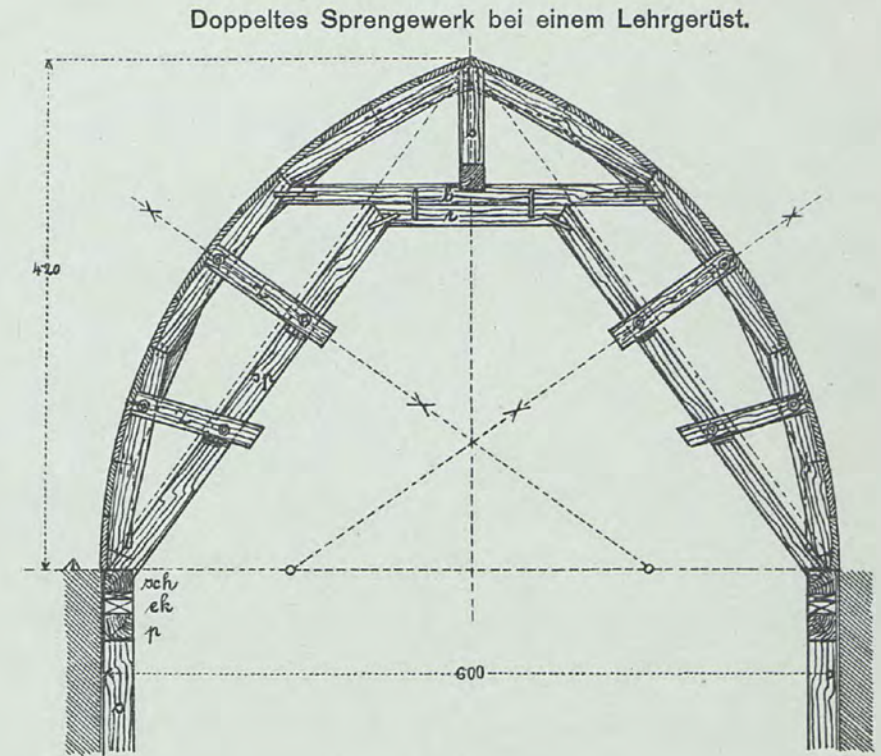
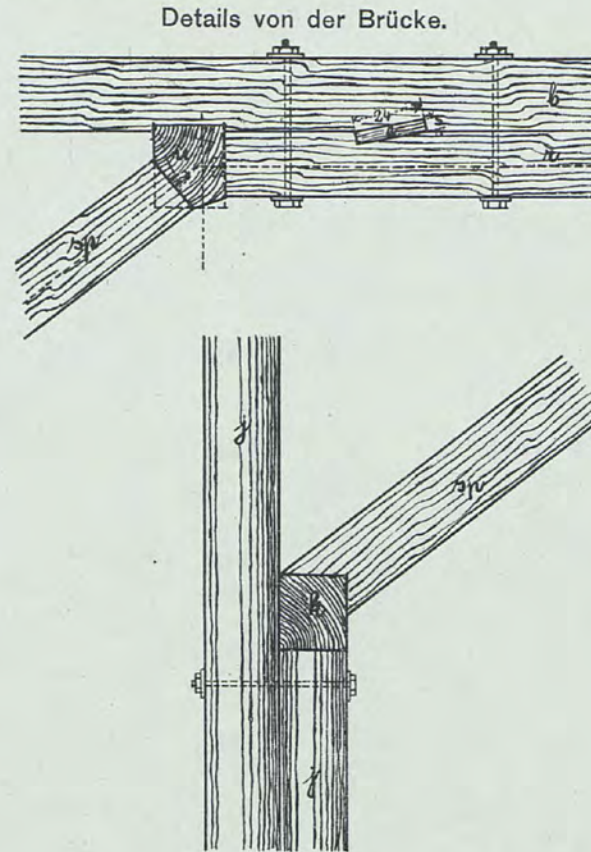
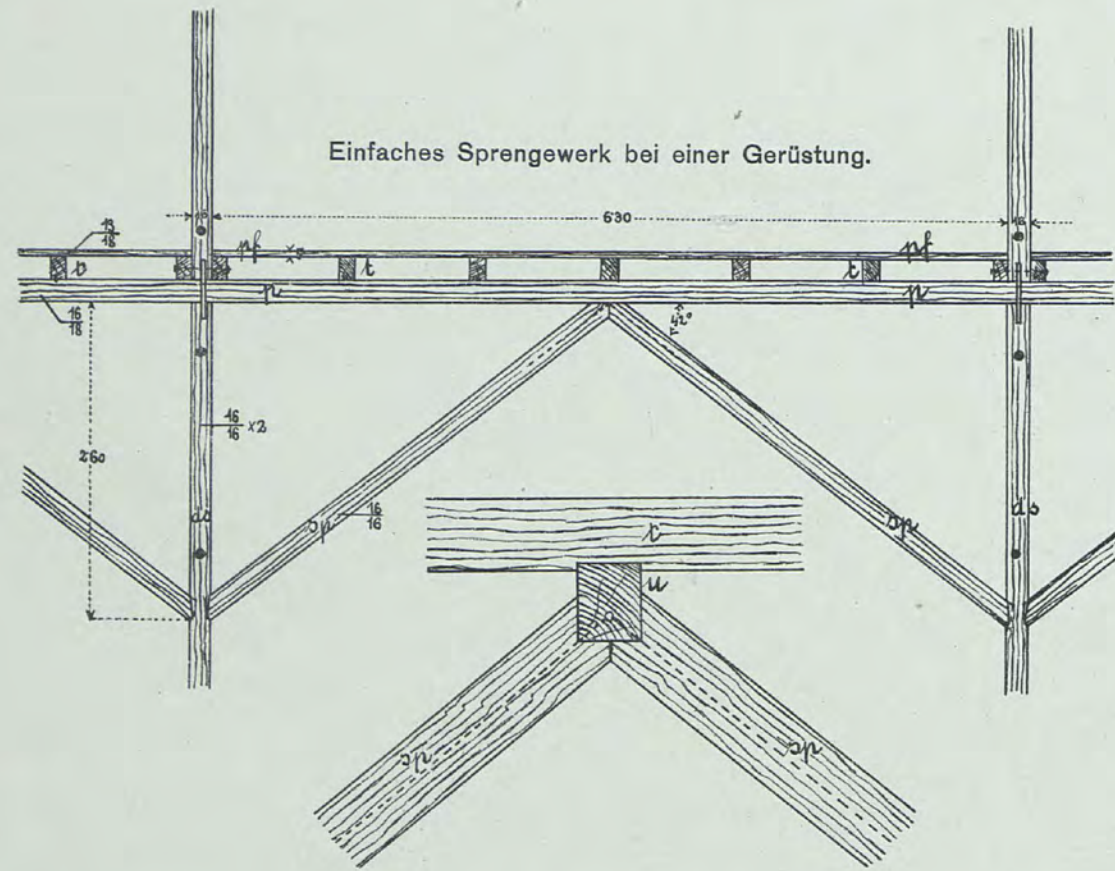

Doppeltes Sprengwerk bei einer Brücke.

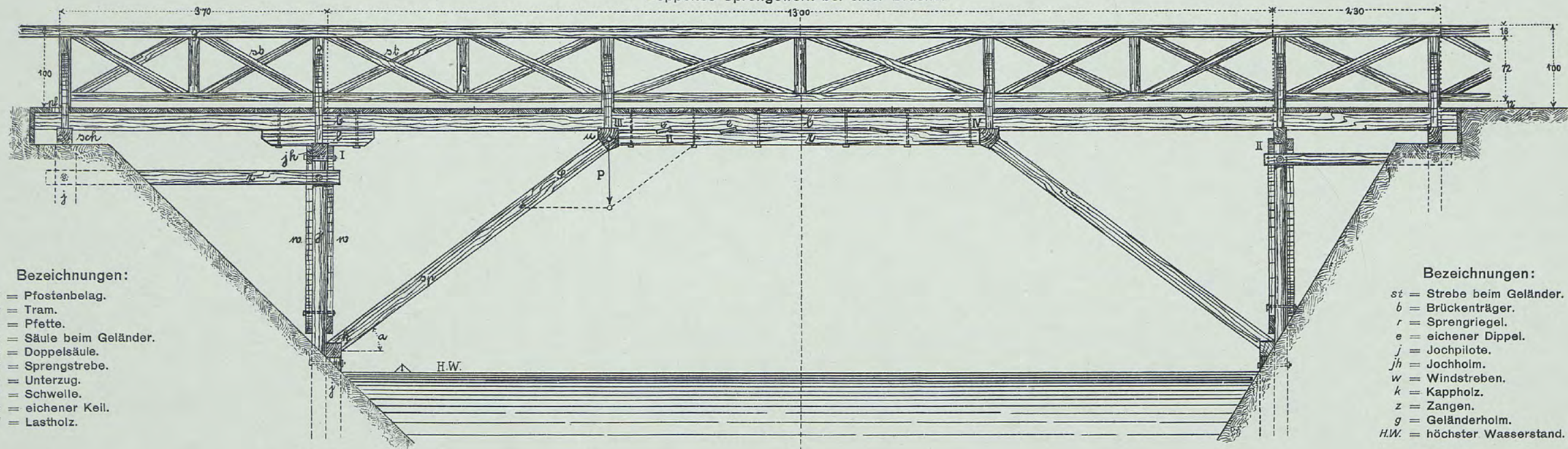

Bezeichnungen:

- pf = Pfostenbelag.
- t = Tram.
- p = Pfette.
- s = Säule beim Geländer.
- ds = Doppelsäule.
- sp = Sprengstrebe.
- u = Unterzug.
- sch = Schwelle.
- ek = eichener Keil.
- l = Lastholz.

Bezeichnungen:

- st = Strebe beim Geländer.
- b = Brückenträger.
- r = Sprengriegel.
- e = eichener Dippel.
- j = Jochpilote.
- jh = Jochholm.
- w = Windstreben.
- k = Kappholz.
- z = Zangen.
- g = Geländerholm.
- H.W. = höchster Wasserstand.

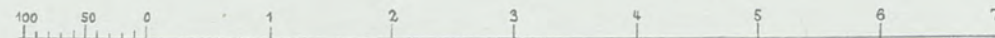

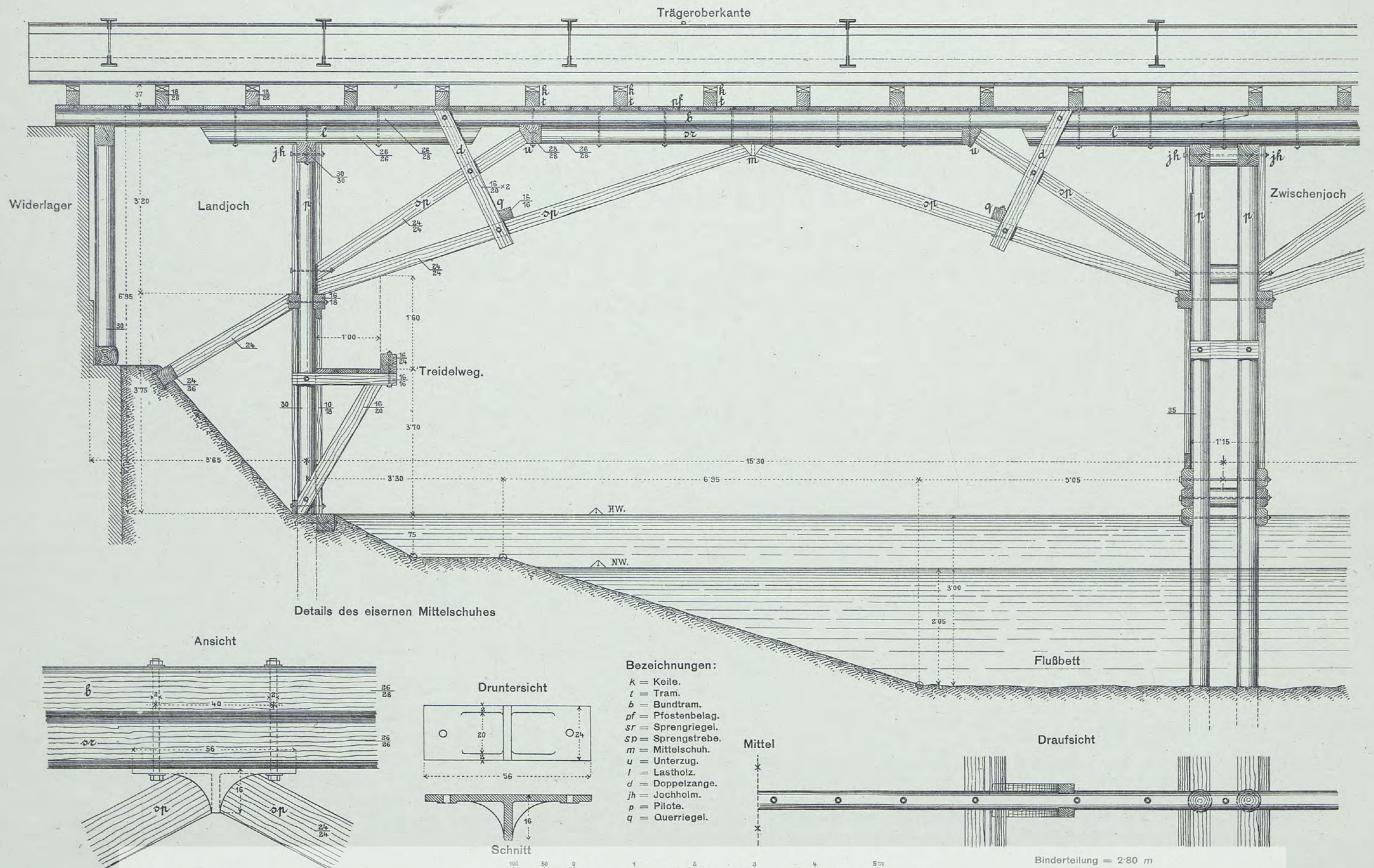

Bezeichnungen:

- k* = Keile.
- t* = Tram.
- b* = Bundtram.
- pf* = Pfostenbelag.
- sr* = Sprengriegel.
- sp* = Sprengstrebe.
- m* = Mittelschuh.
- u* = Unterzug.
- l* = Lastholz.
- d* = Doppelzange.
- jh* = Jochholm.
- p* = Pilote.
- q* = Querriegel.

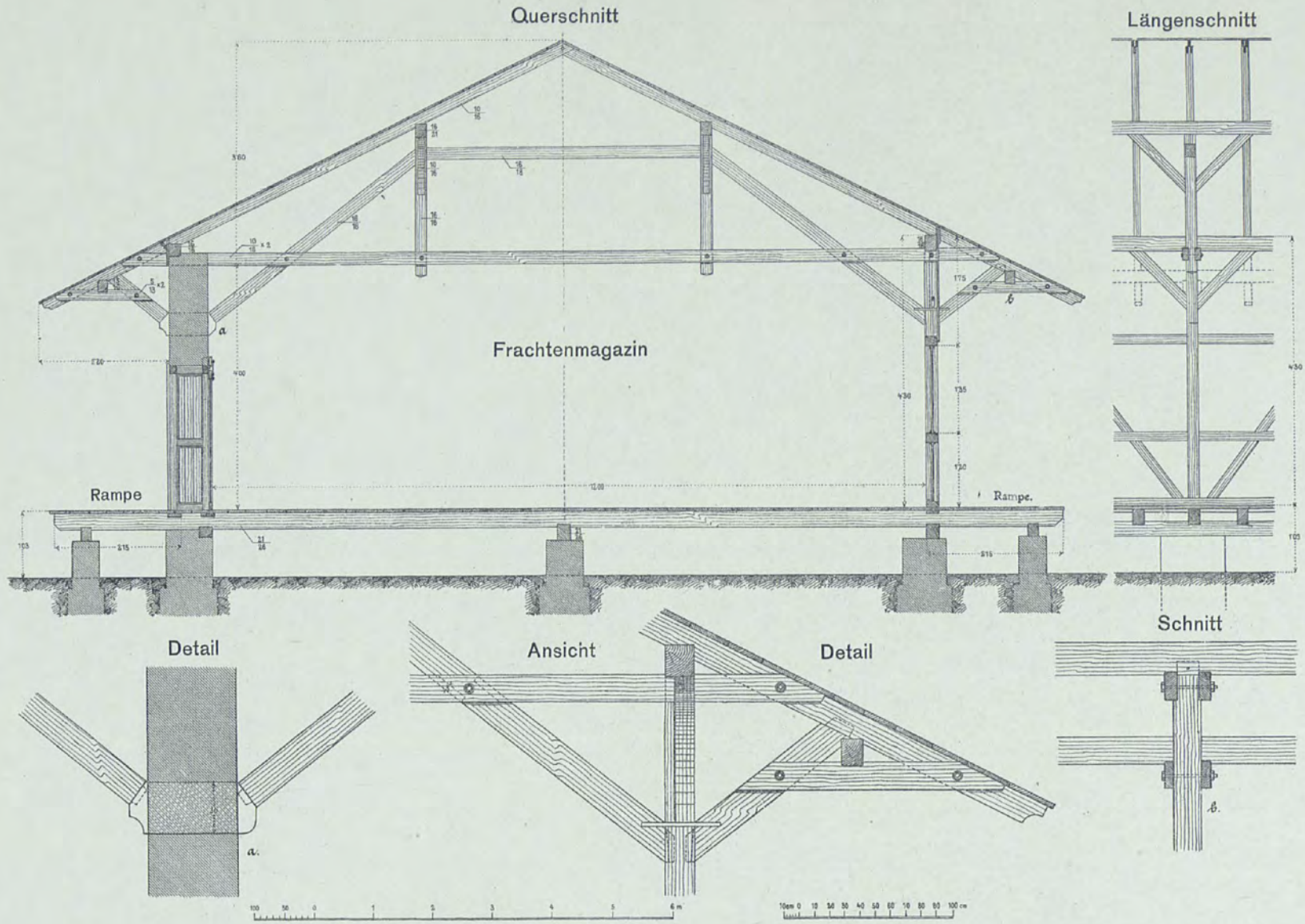

Hallendächer

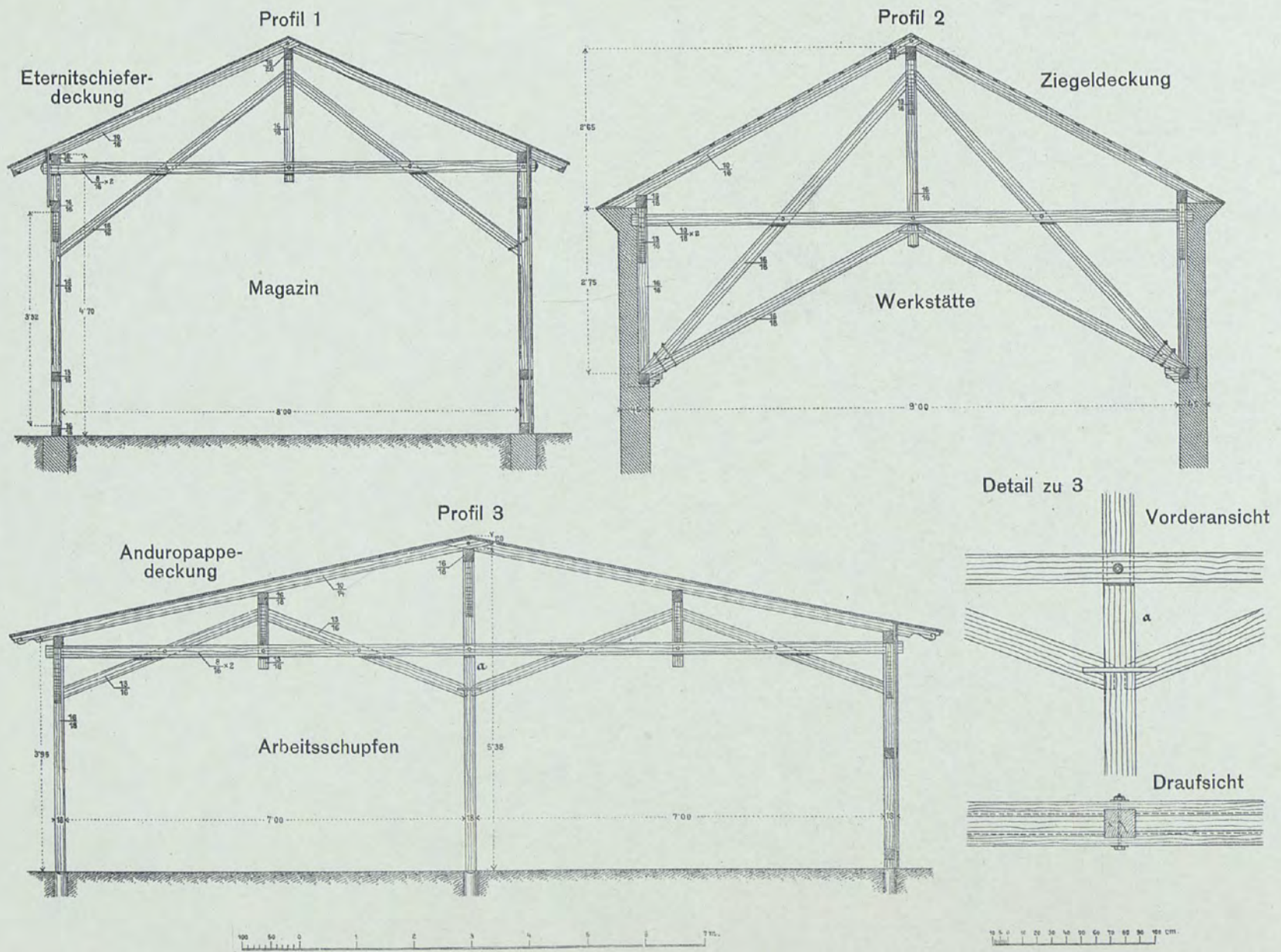

DER ZIMMERER-MEISTER, I. TEIL, Nr. 35
 VEREINIGTE HÄNGE- UND SPRENGWERKE

Sparrendach 1

Stehender Stuhl 4

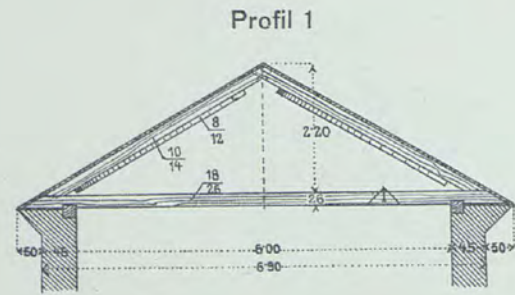

Längenschnitt 1

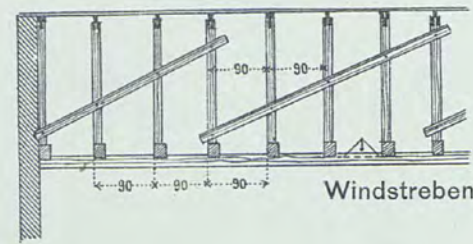

Profil 4

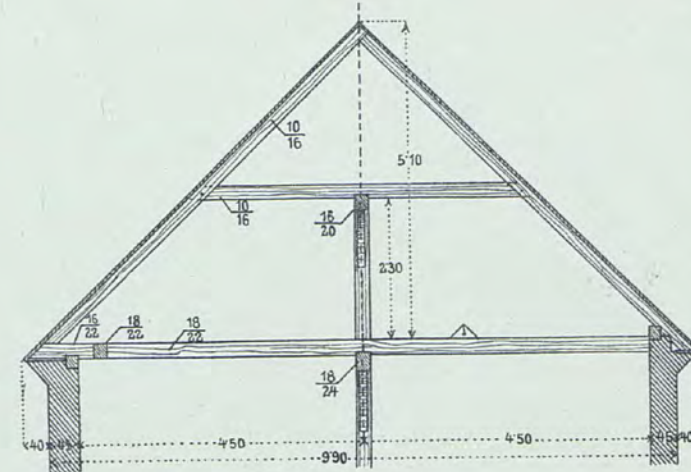

Längenschnitt 4

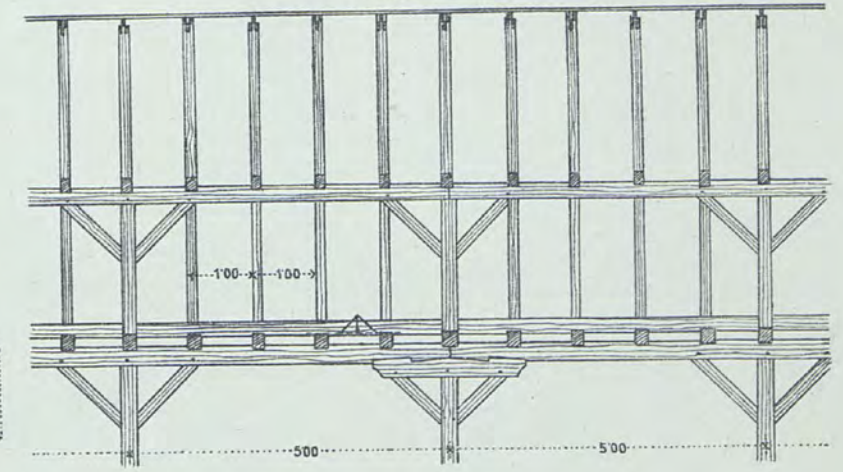

Werksatz 1 mit Tramlage

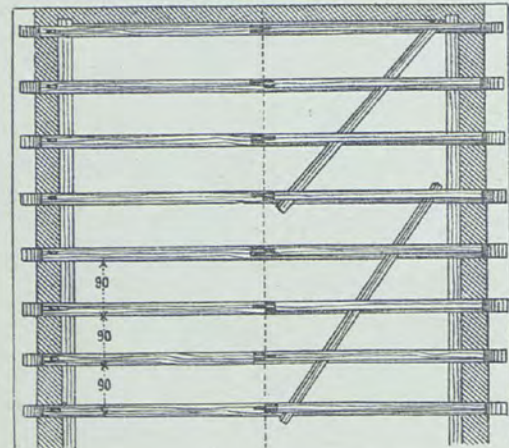

Werksatz 1 mit Stich und Wechsel

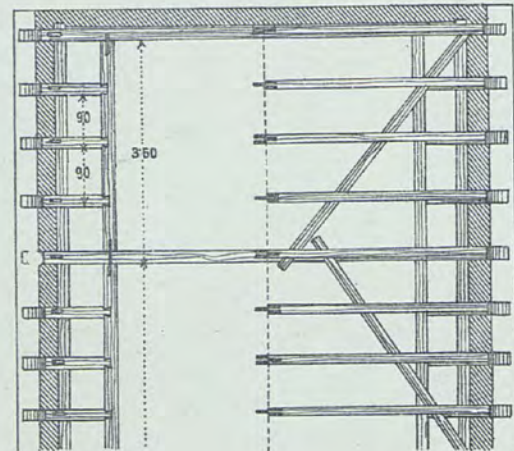

Werksatz 4

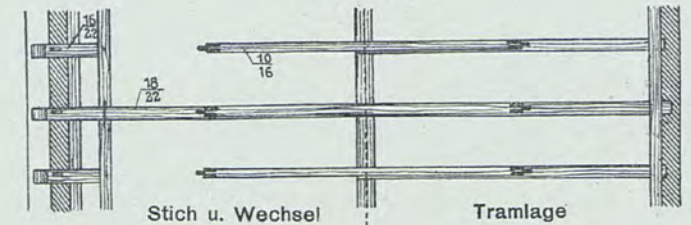

Sparrenkupplungen

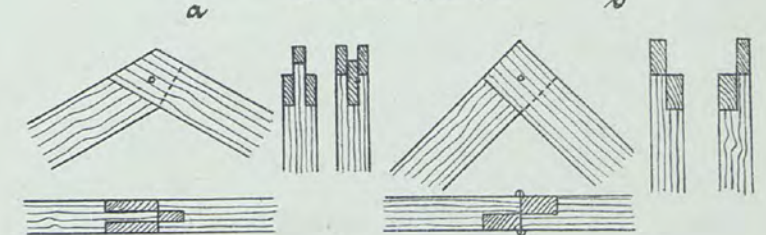

Profil 2

Kehlbalkendach 2

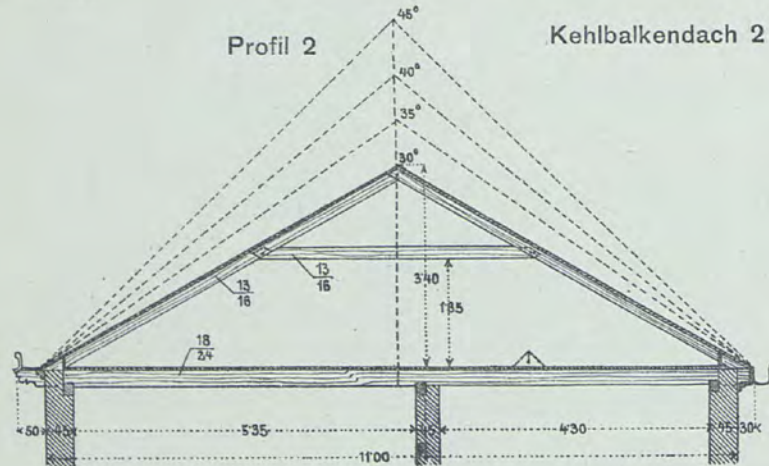

Längenschnitt 2

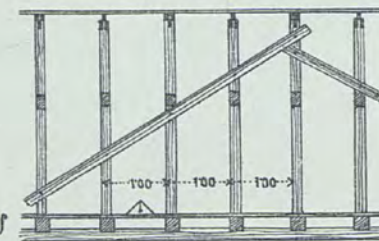

Profil 5

Hängewerk mit Dachriegel 5

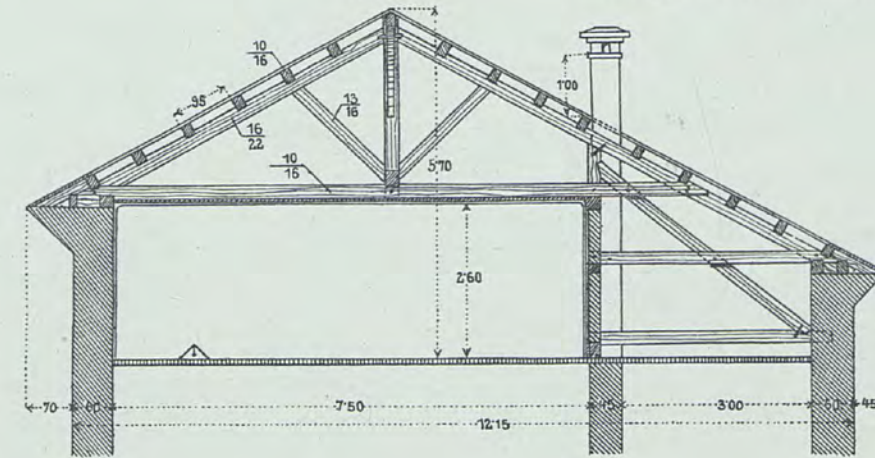

Längenschnitt 5

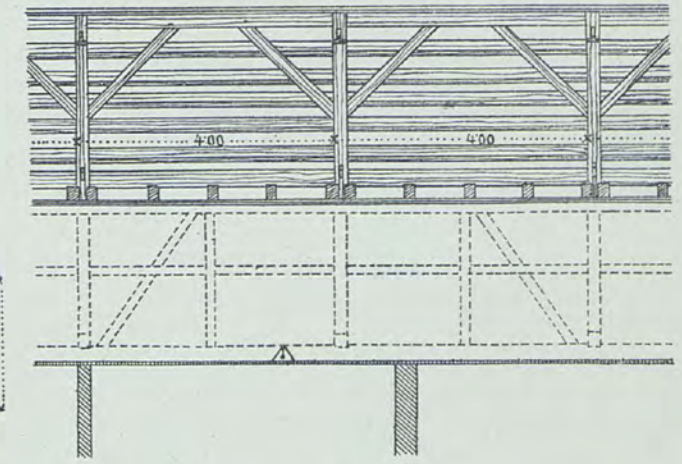

Kehlbalkendach mit Trette 3

Profil 3

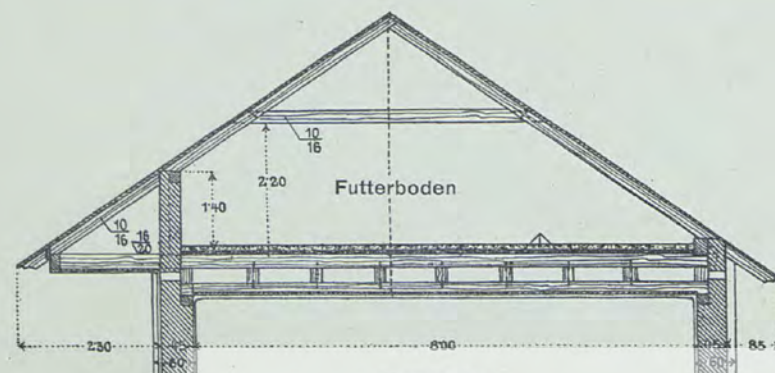

Längenschnitt 3

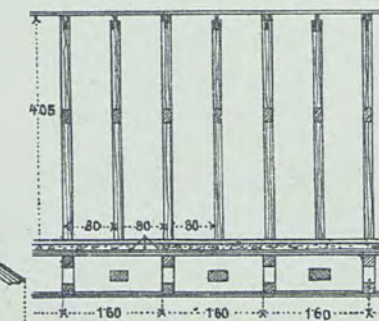

Saumdetail zu 2

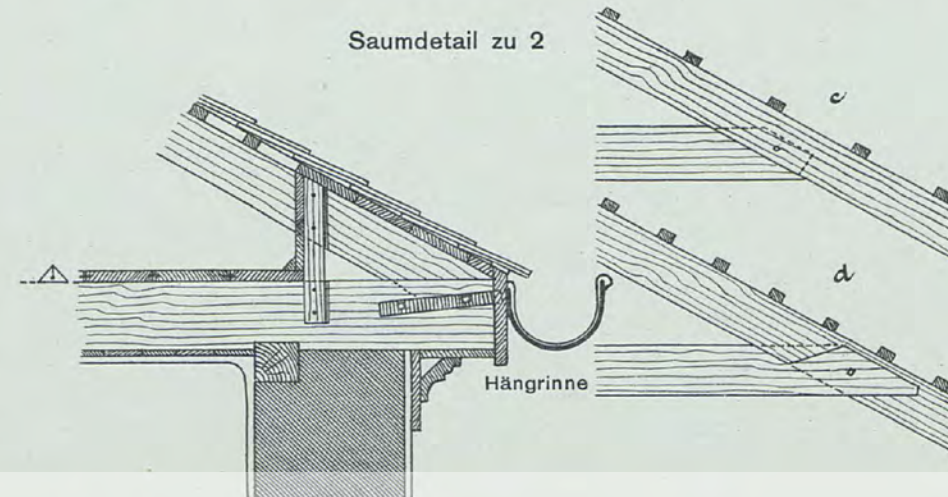

Kehlbalkendetails

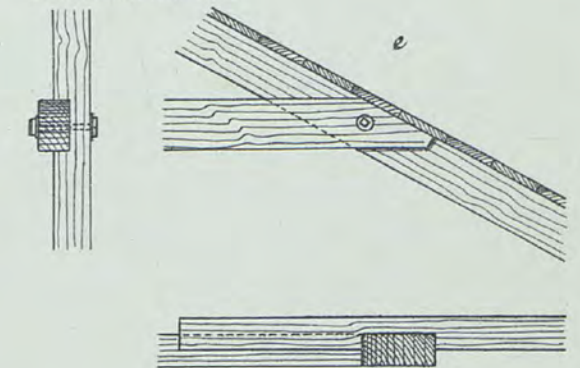

Kehlbalkendach mit liegendem Stuhl 1

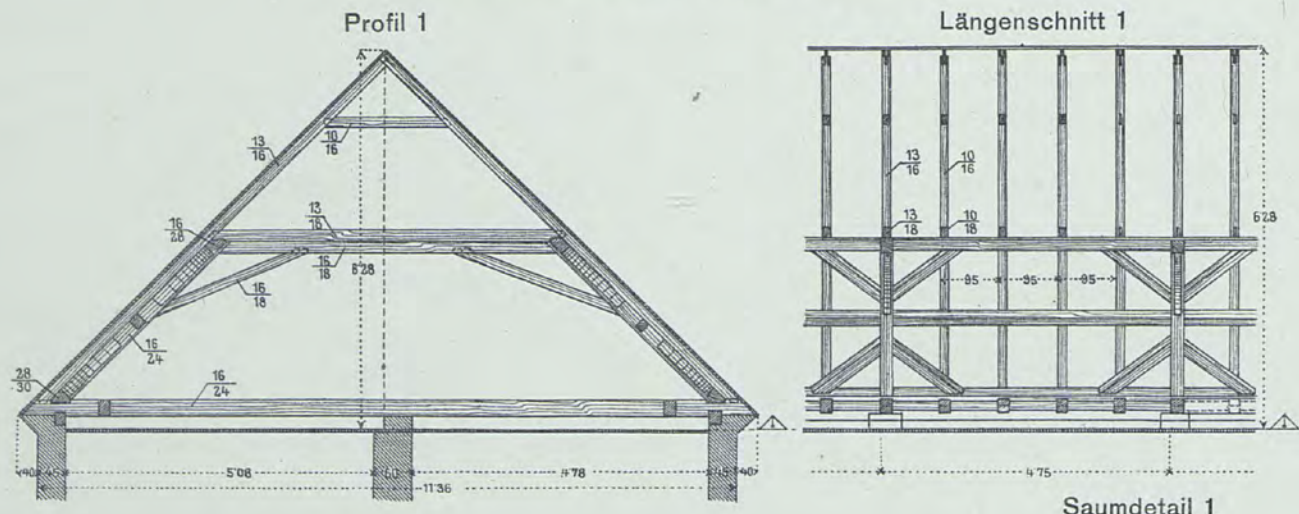

Pfettendach mit liegendem Stuhl 2

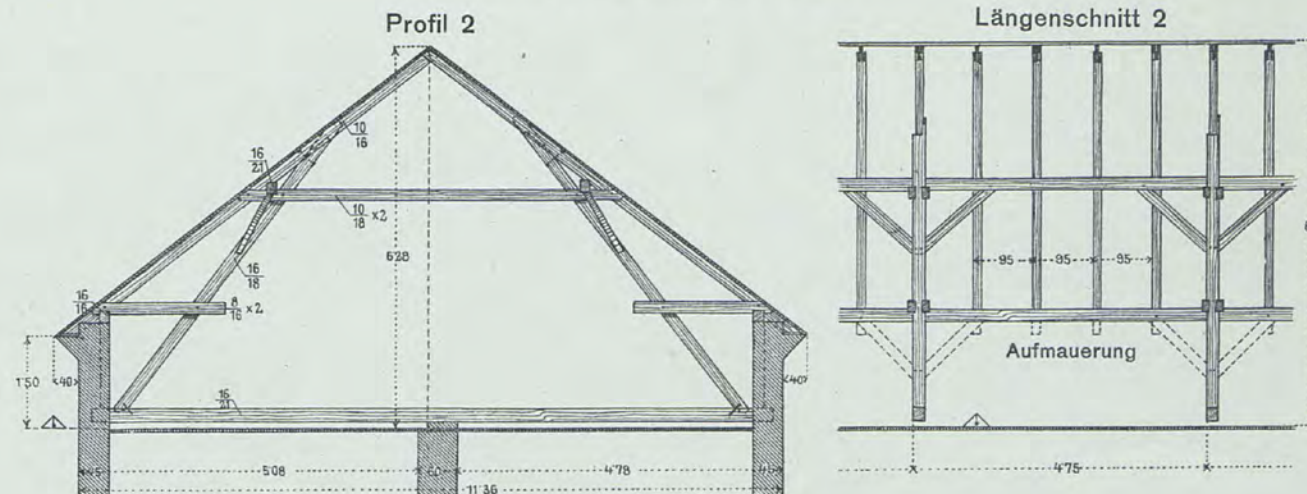

Werksatz 1

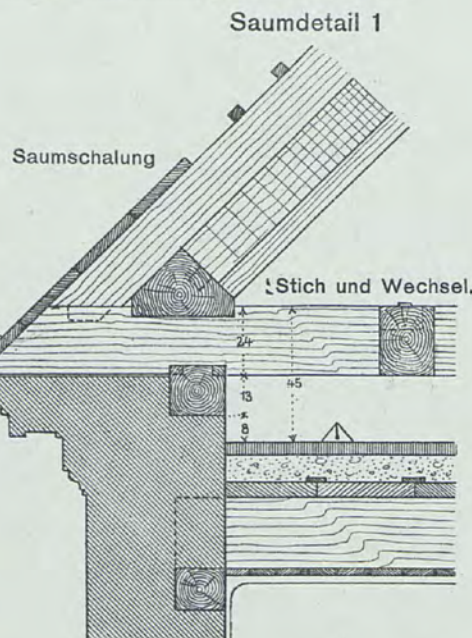
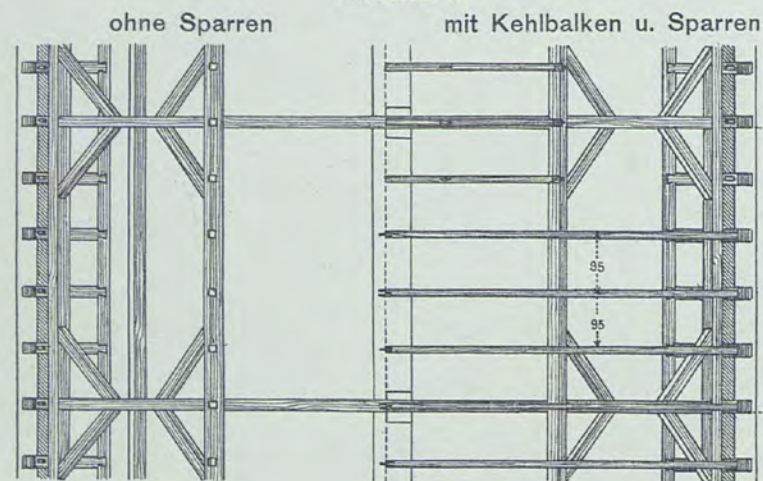

Werksatz 2

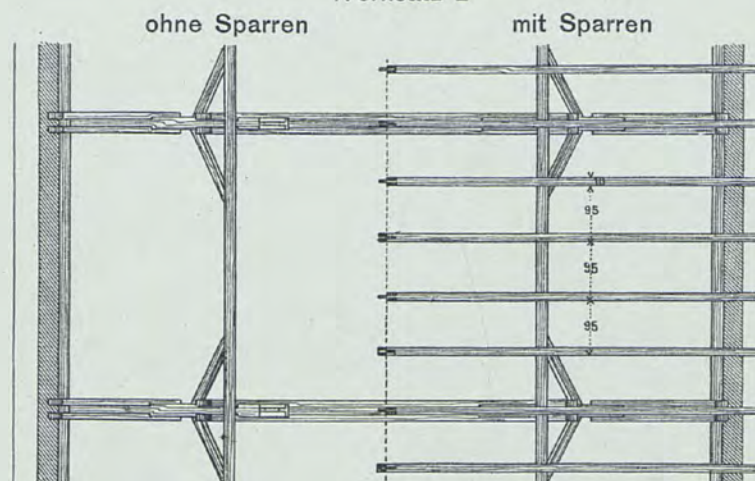

Holzanzug:

Kehlbalkendach mit liegendem Stuhl, Profil 1;
Binderteilung 4.75 m; Firsthöhe 6.28 m;
Einlattung für Ziegeldeckung: 1 m² Grundfläche = 0.096 m³ Holz.

Pfettendach mit liegendem Stuhl, Profil 2;
Binderteilung 4.75 m; Firsthöhe 6.28 m;
Einlattung für Ziegeldeckung: 1 m² Grundfläche = 0.065 m³ Holz.

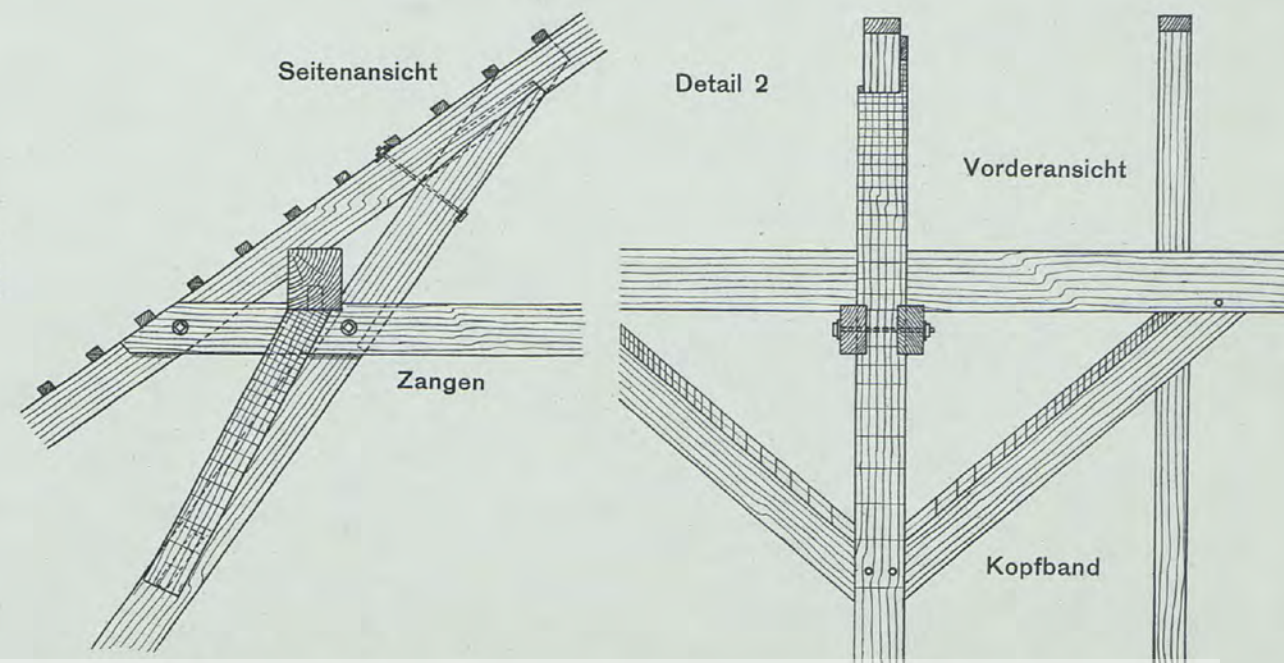
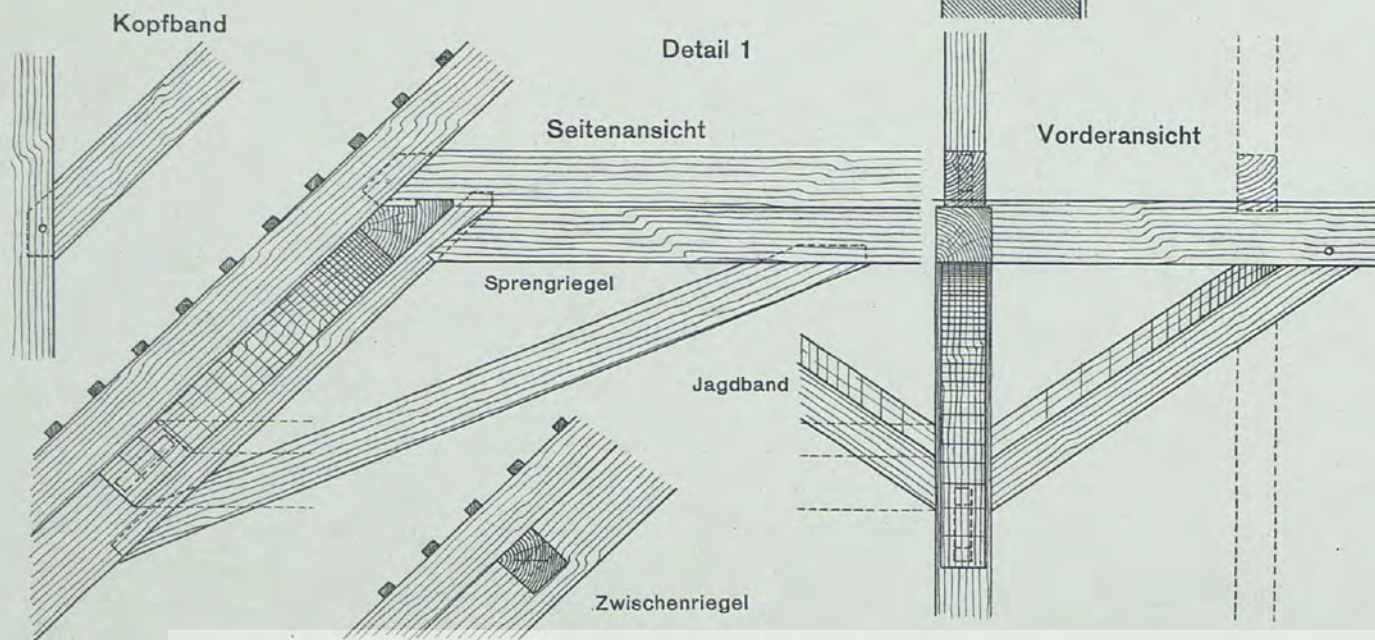

Liegender Stuhl.

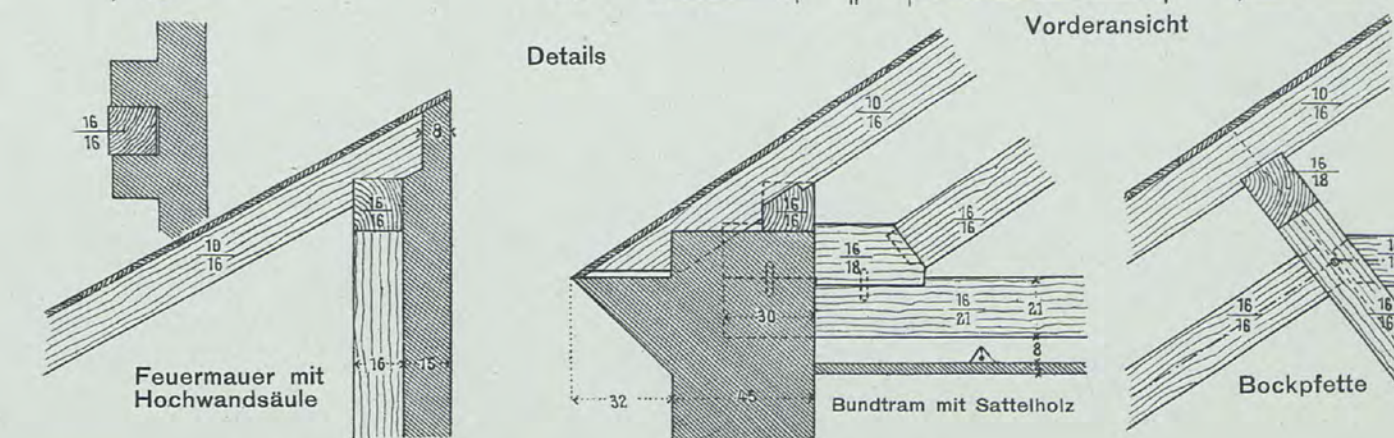
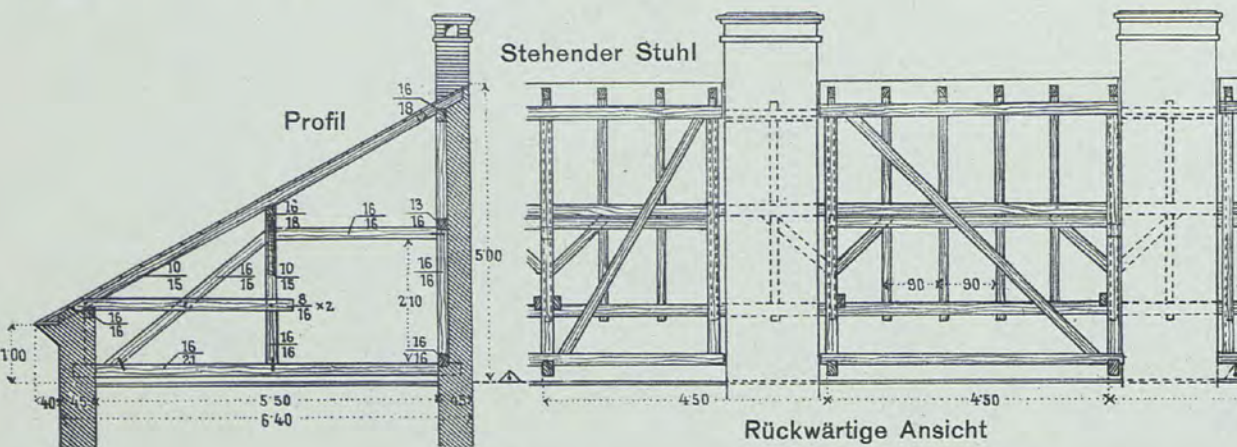
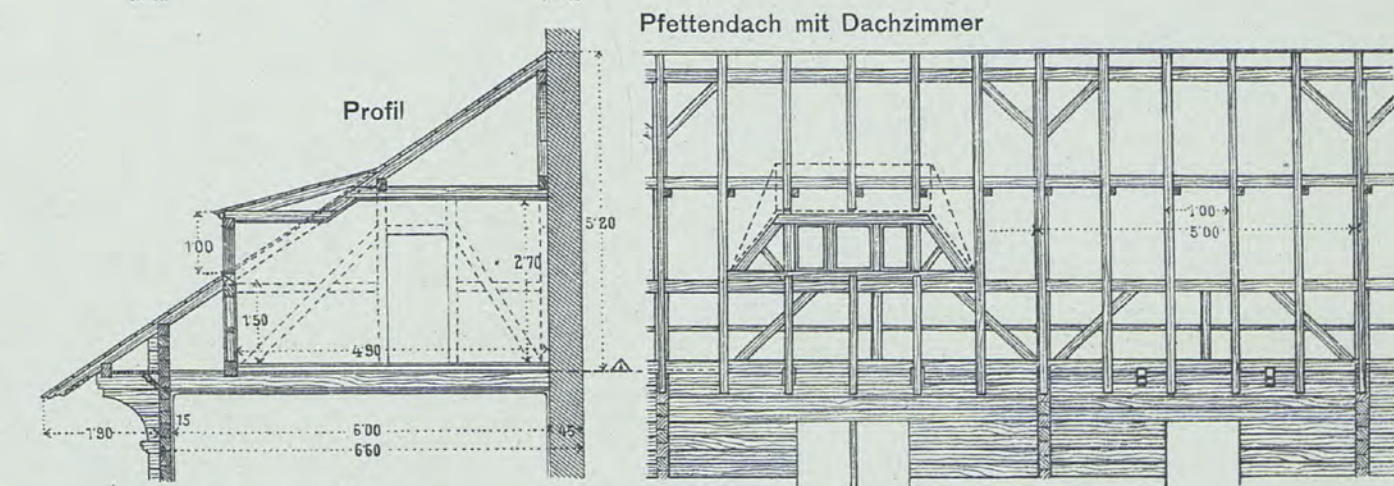
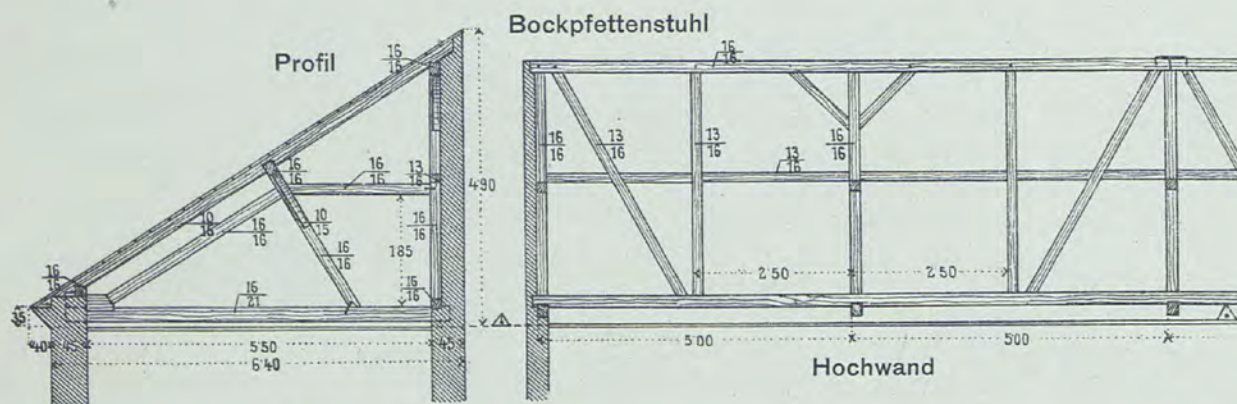
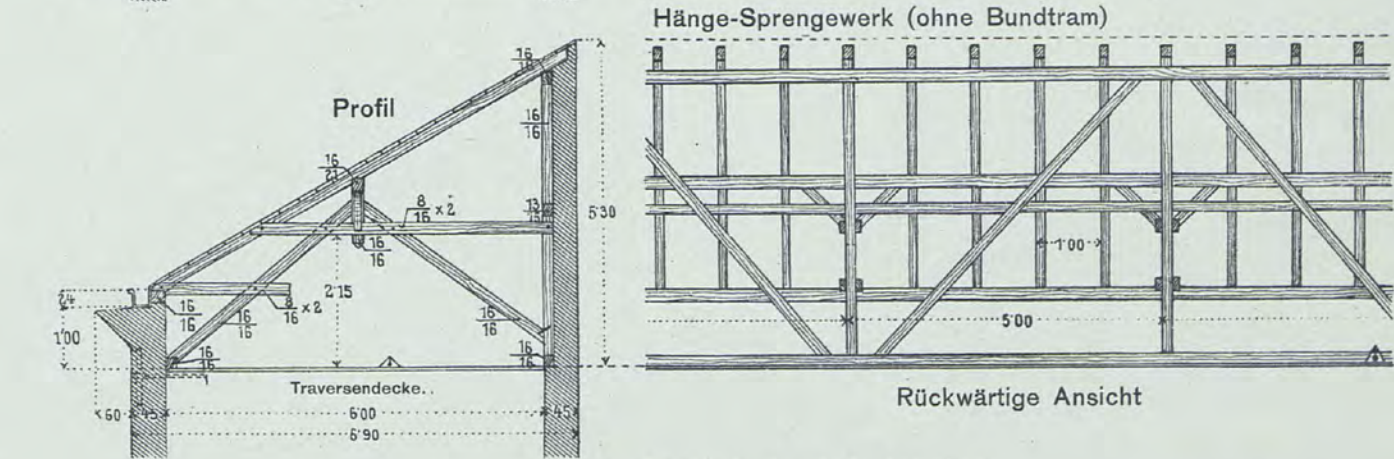
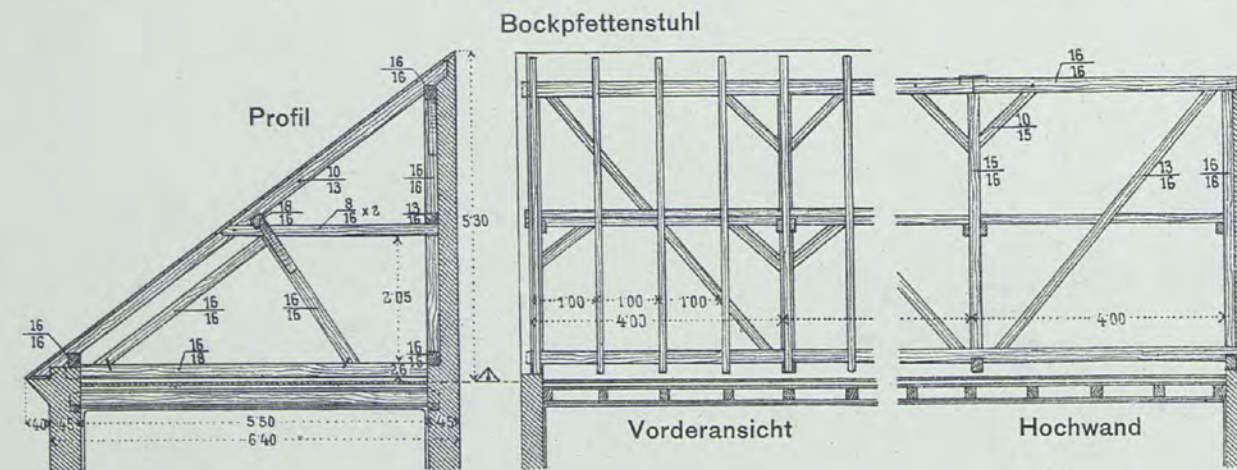
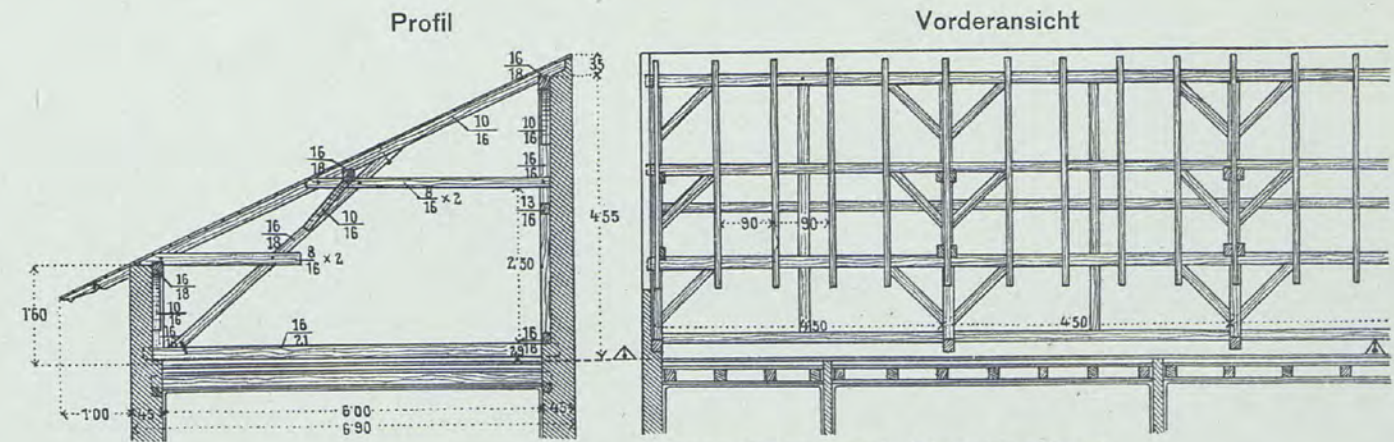
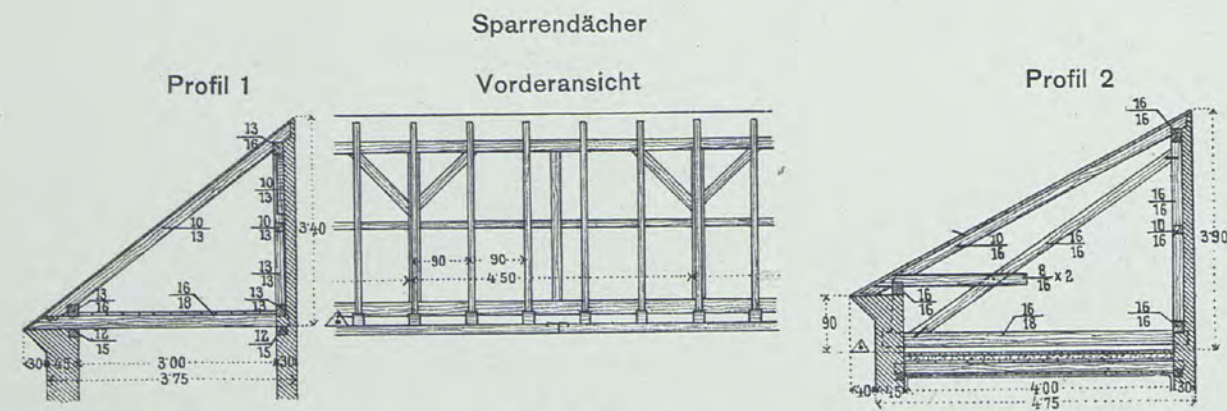

Profil über ein Wohngebäude 1

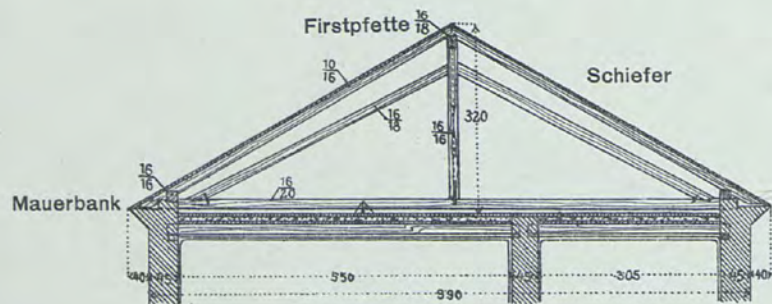

Längenschnitt 1

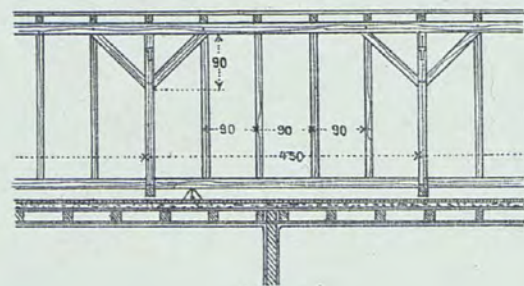

Profil über einen Riegelwandbau 2

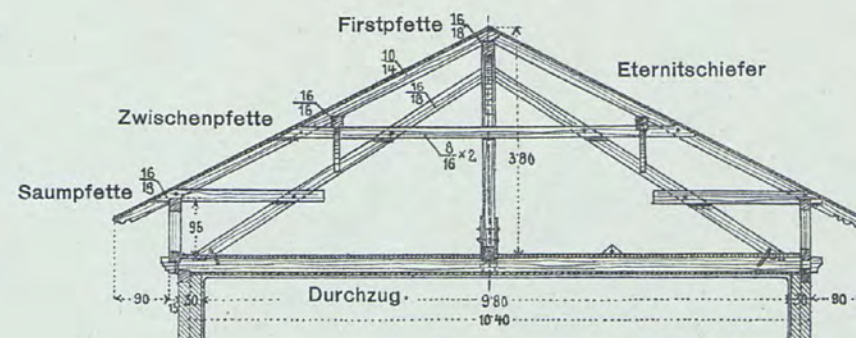

Ansicht 2

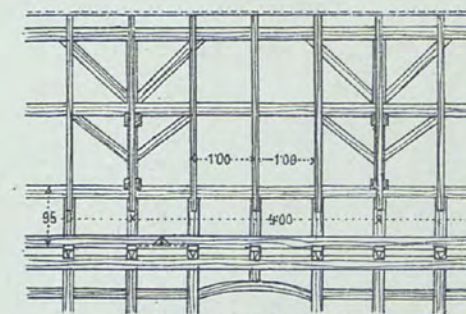

Profil über einen Saalbau 3

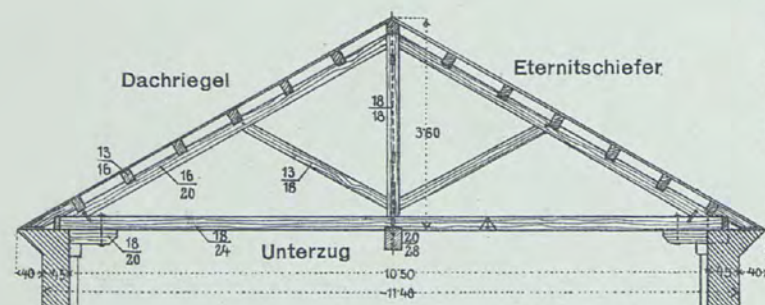

Längenschnitt 3

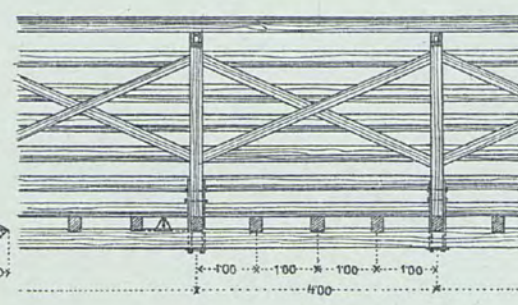

Profil über ein Wohnhaus 4

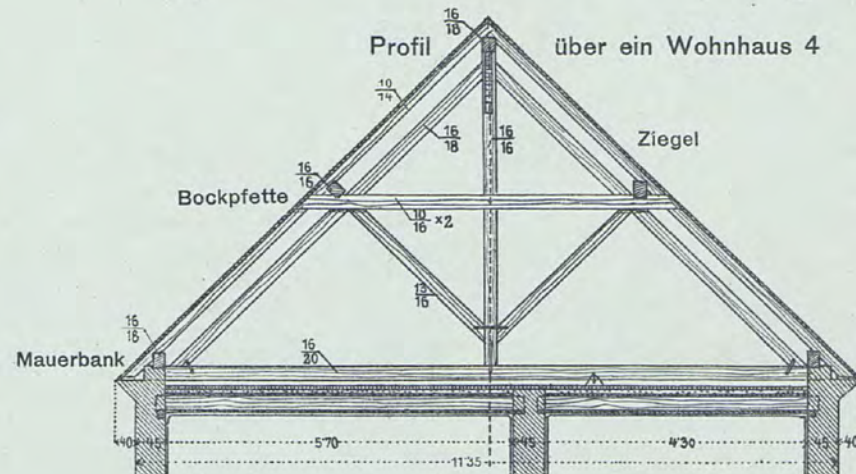

Längenschnitt 4

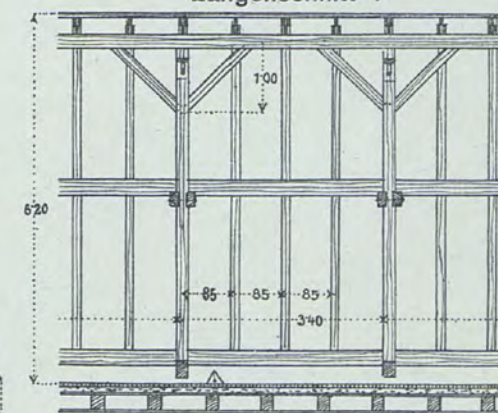

Profil über ein Wirtschaftsgebäude 5

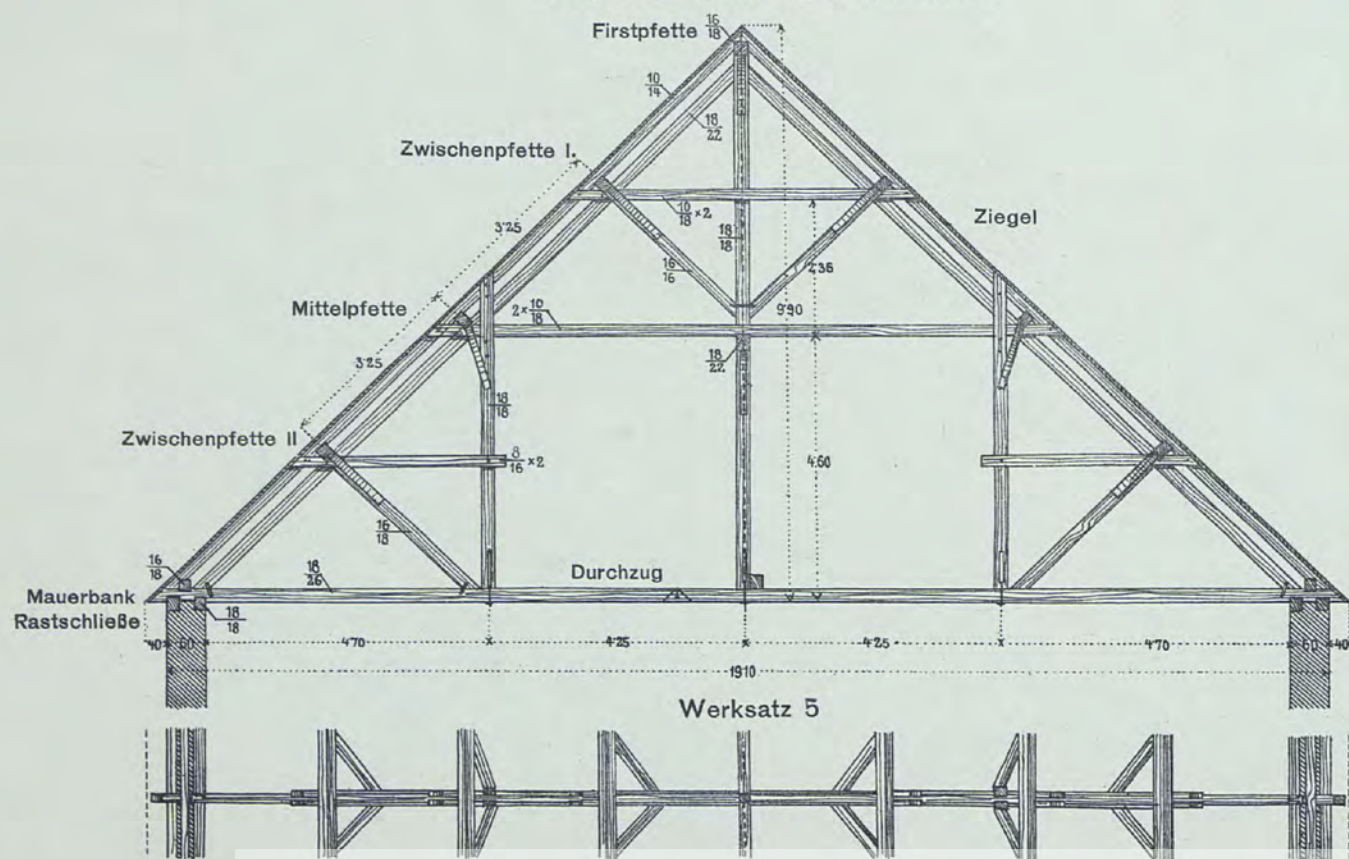

Längenschnitt 5

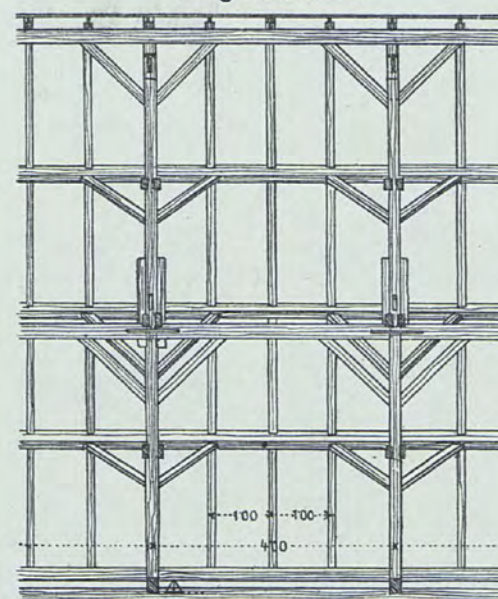

Details zu 5

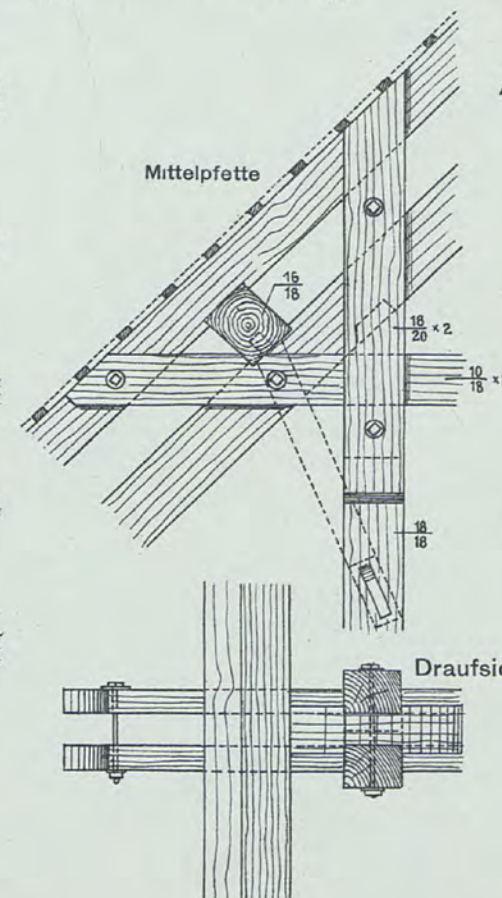

Ansichten

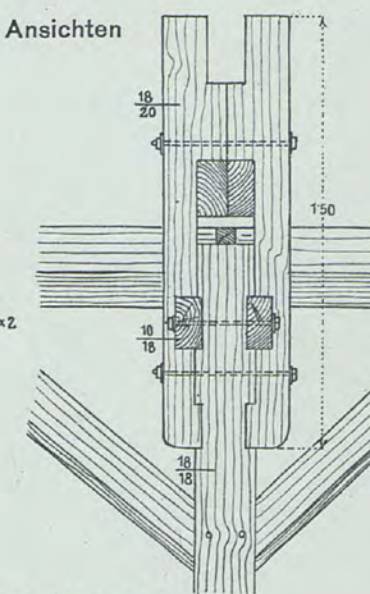

Profil über ein Wohnhaus

Profil über die Staatsgewerbeschule in Wien I

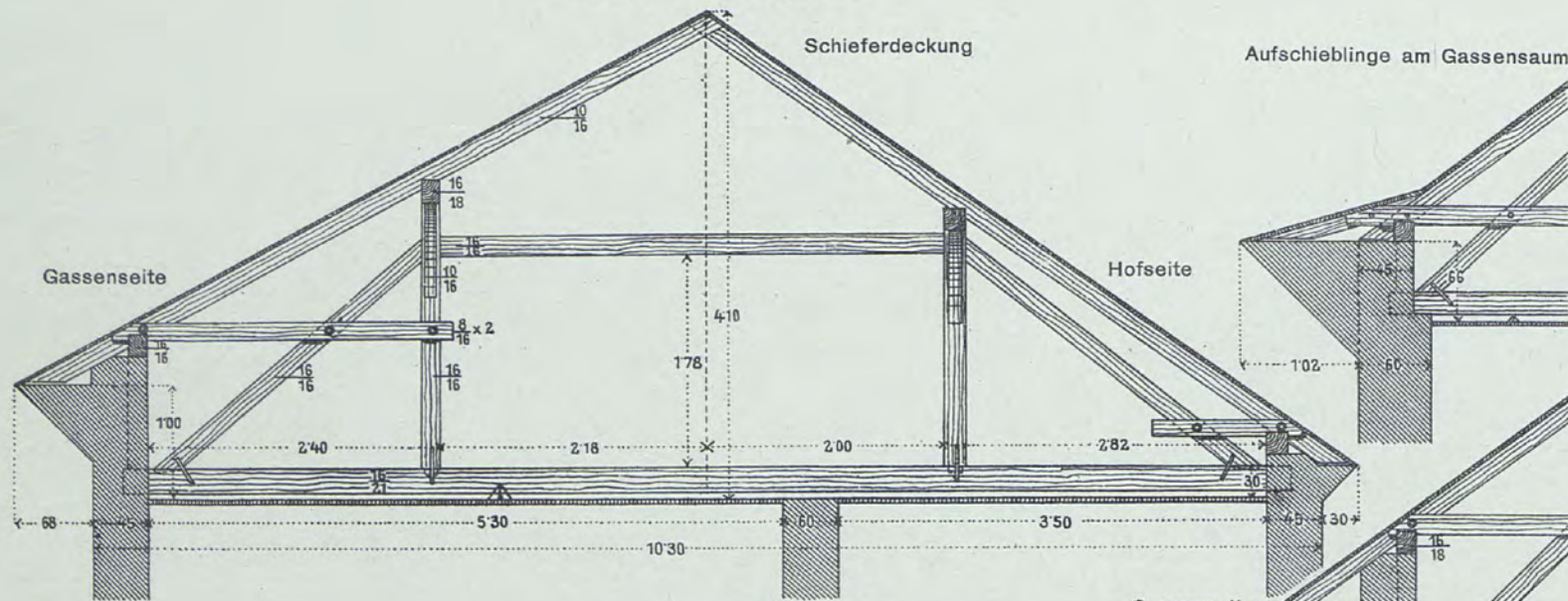

Aufschieblinge am Gassensaum

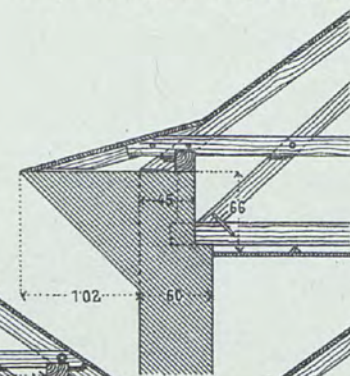

Gassenseite

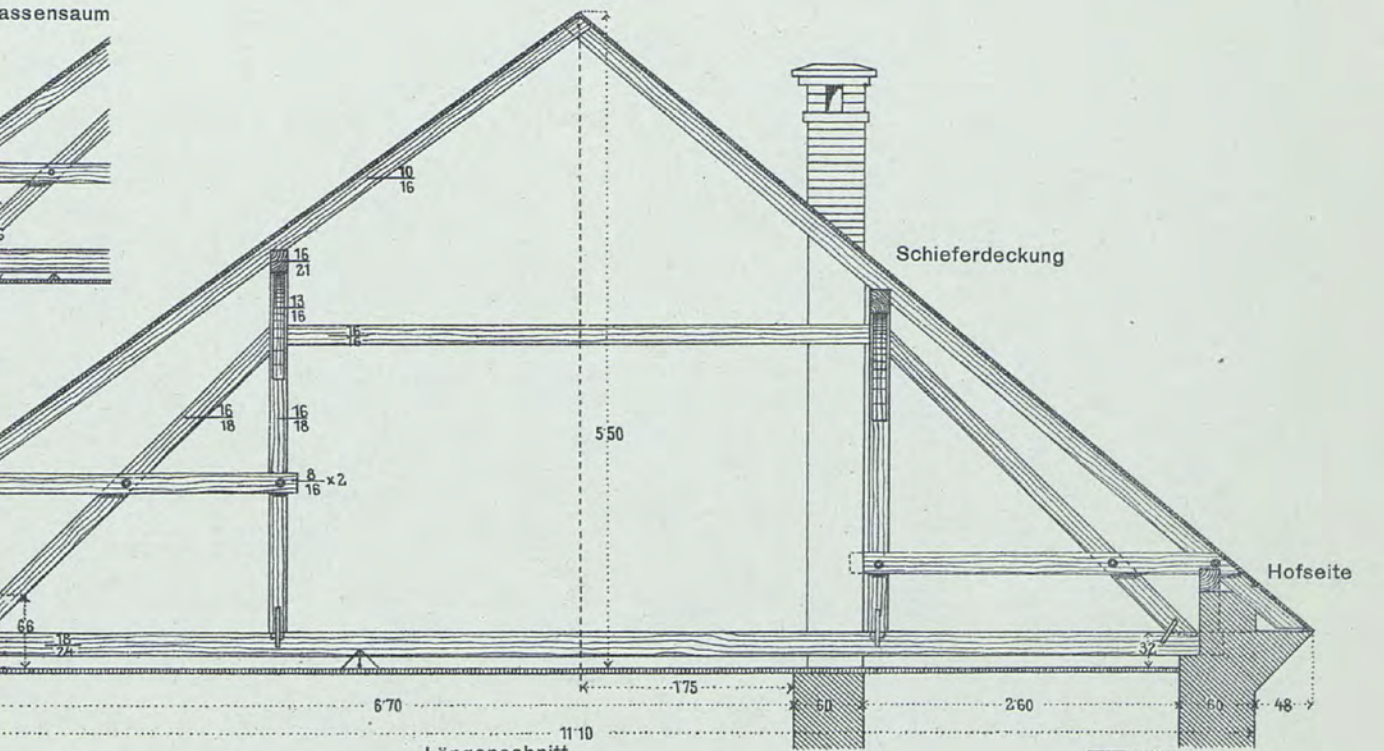
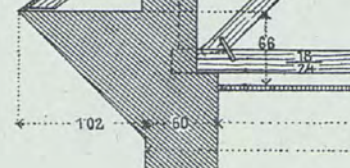

Längenschnitt

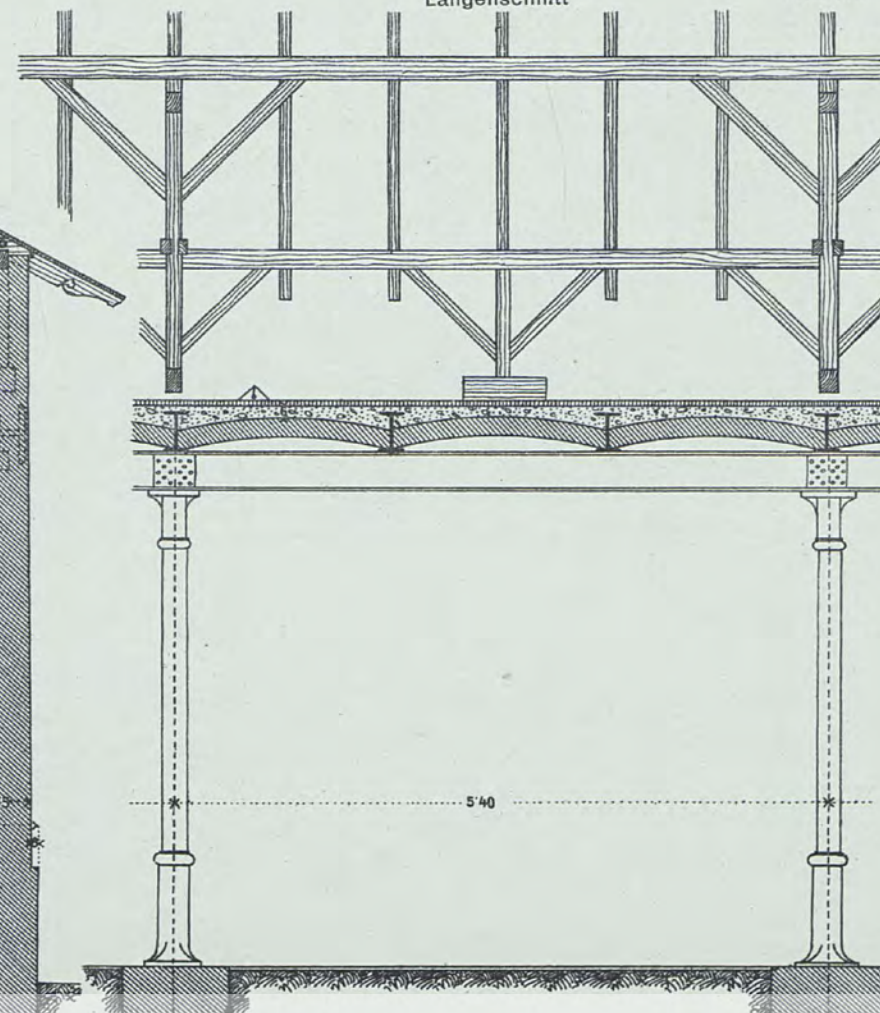

Profil über ein Wirtschaftsgebäude

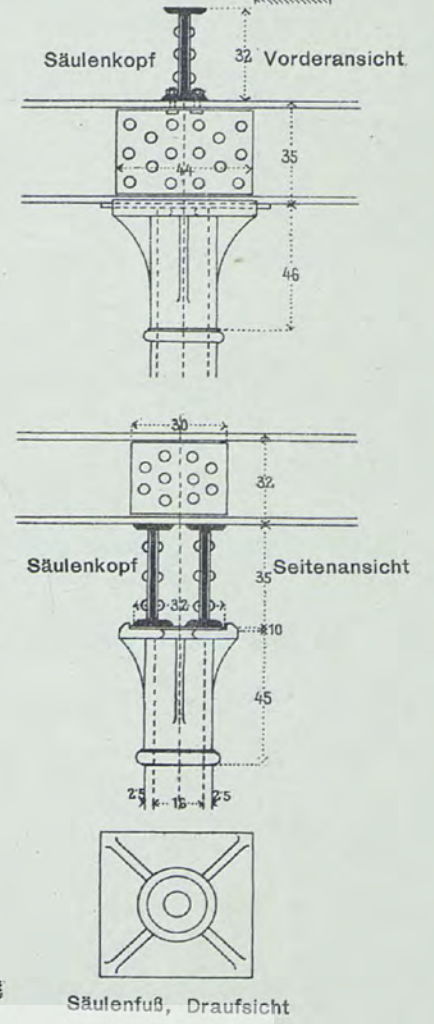
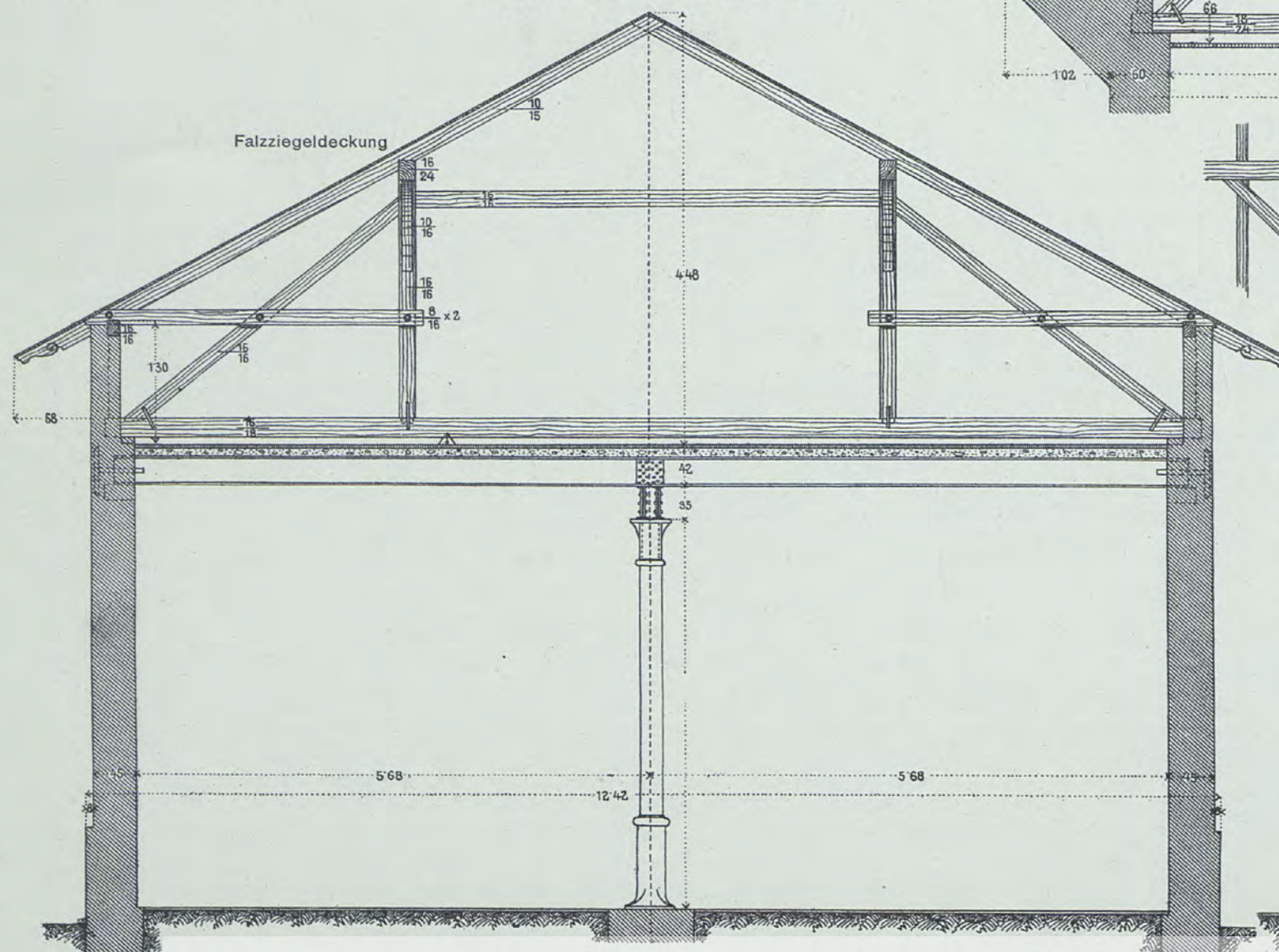

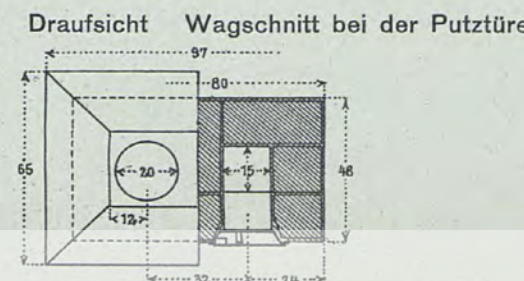
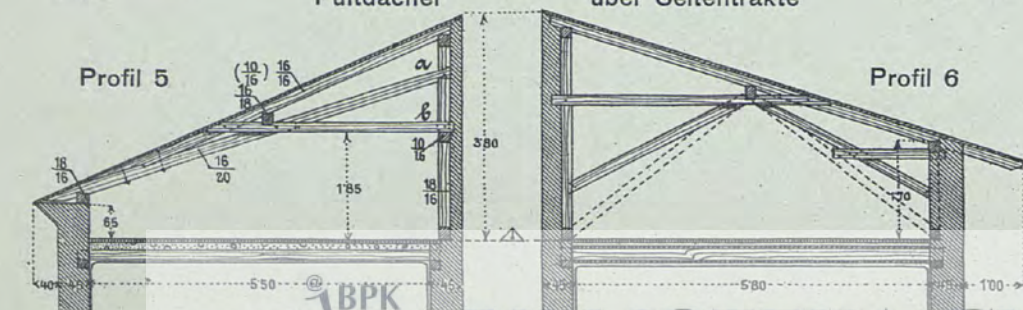
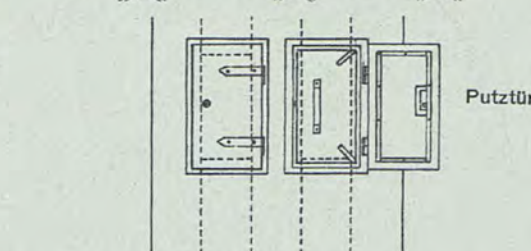
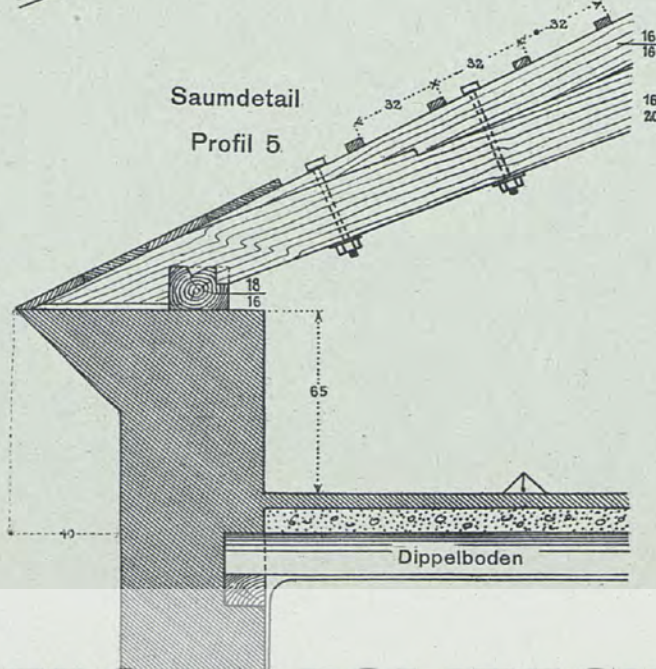
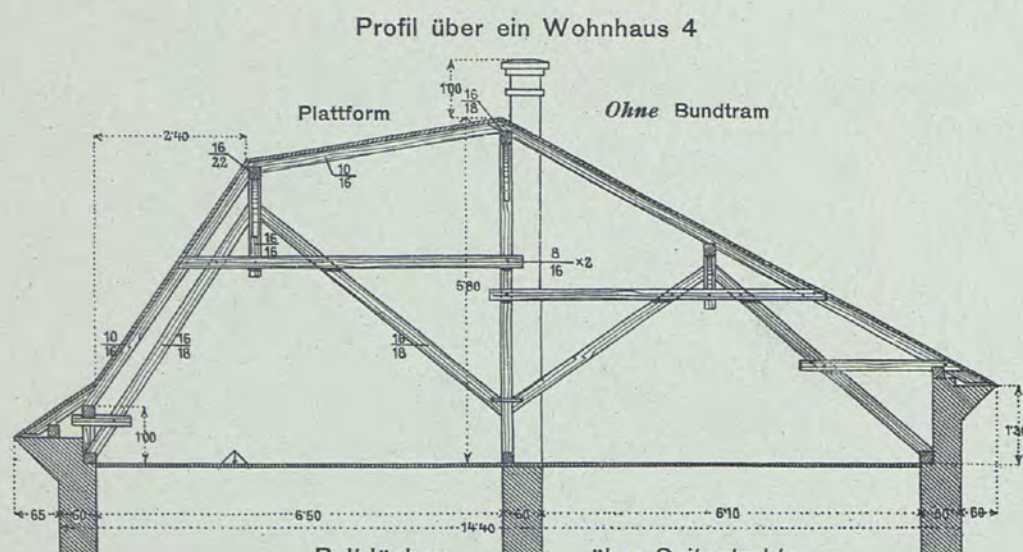
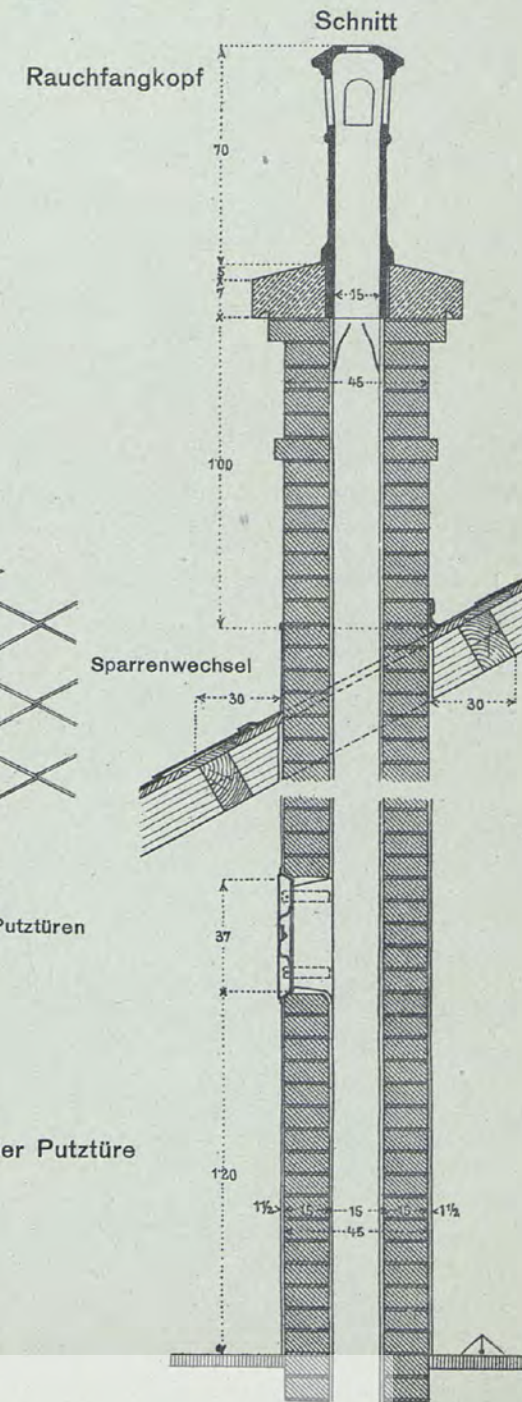
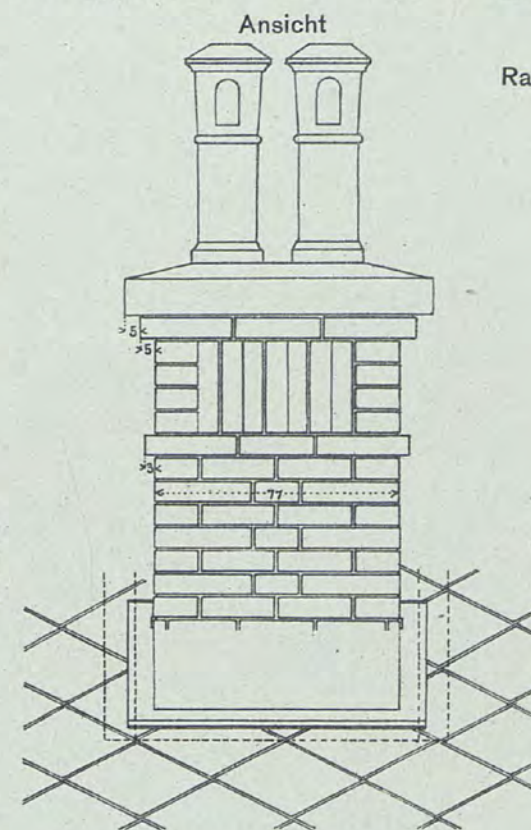
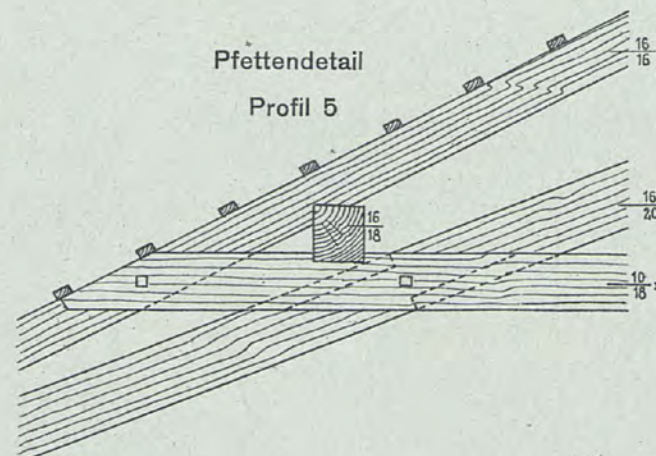
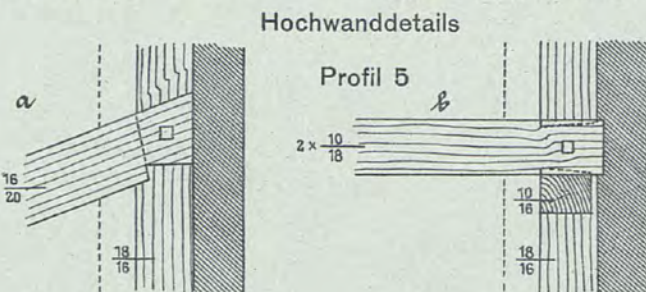
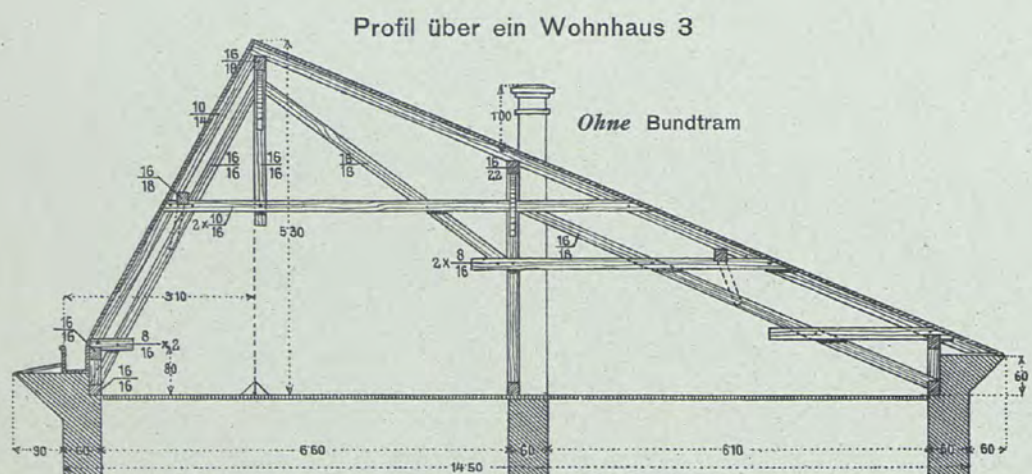
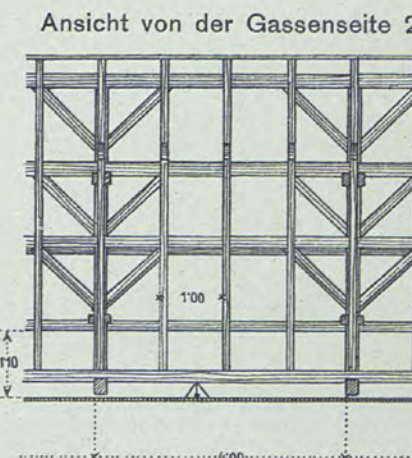
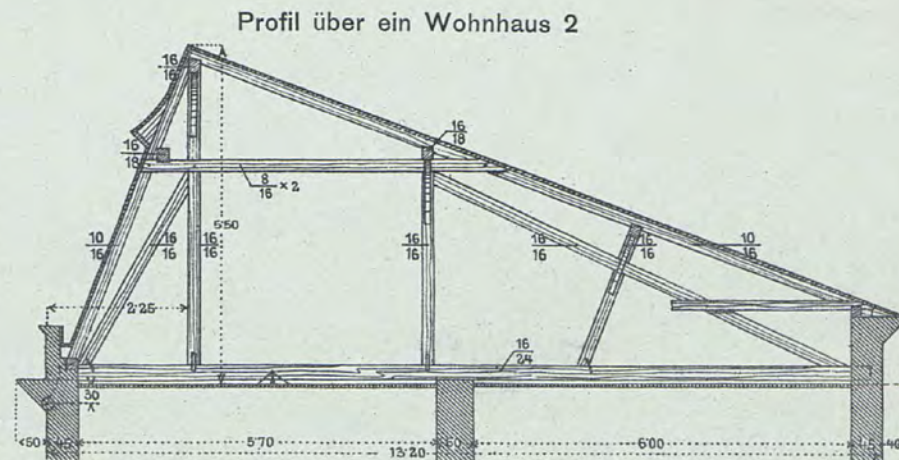
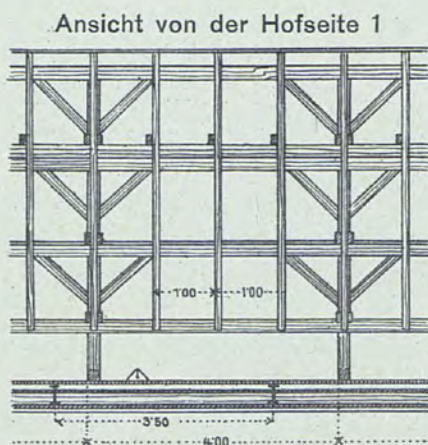
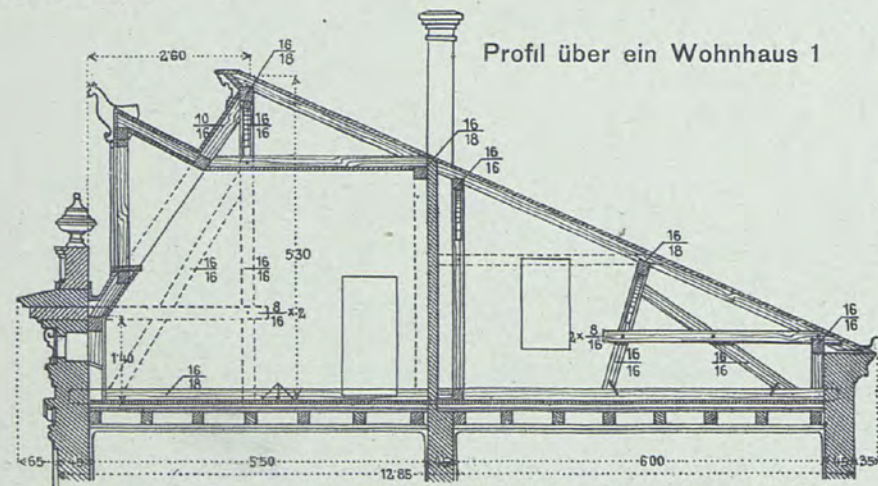

Werksatz 1

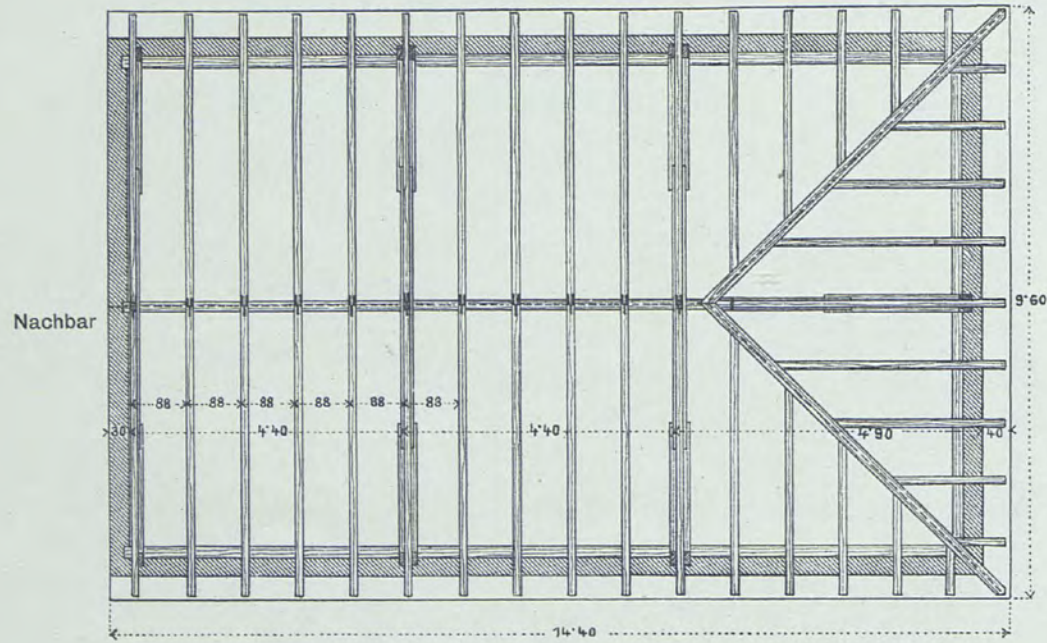

Profil 1

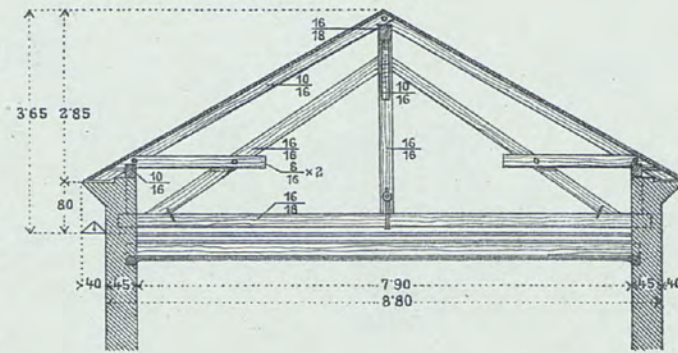

Längenschnitt 1

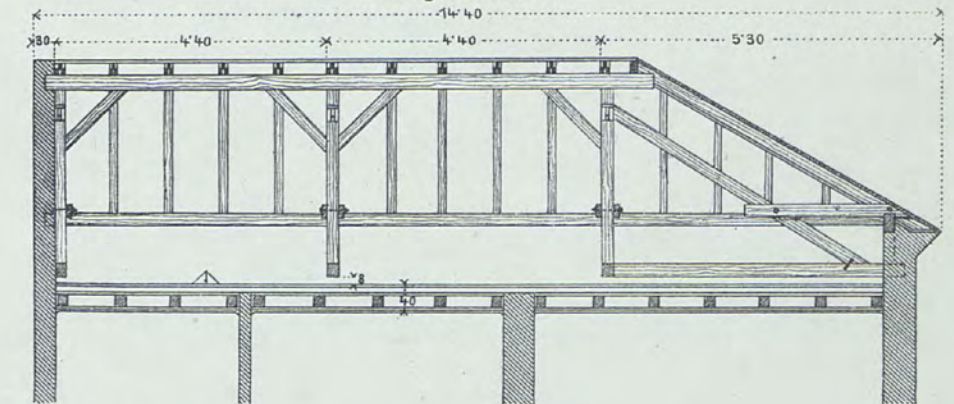

Werksatz 2

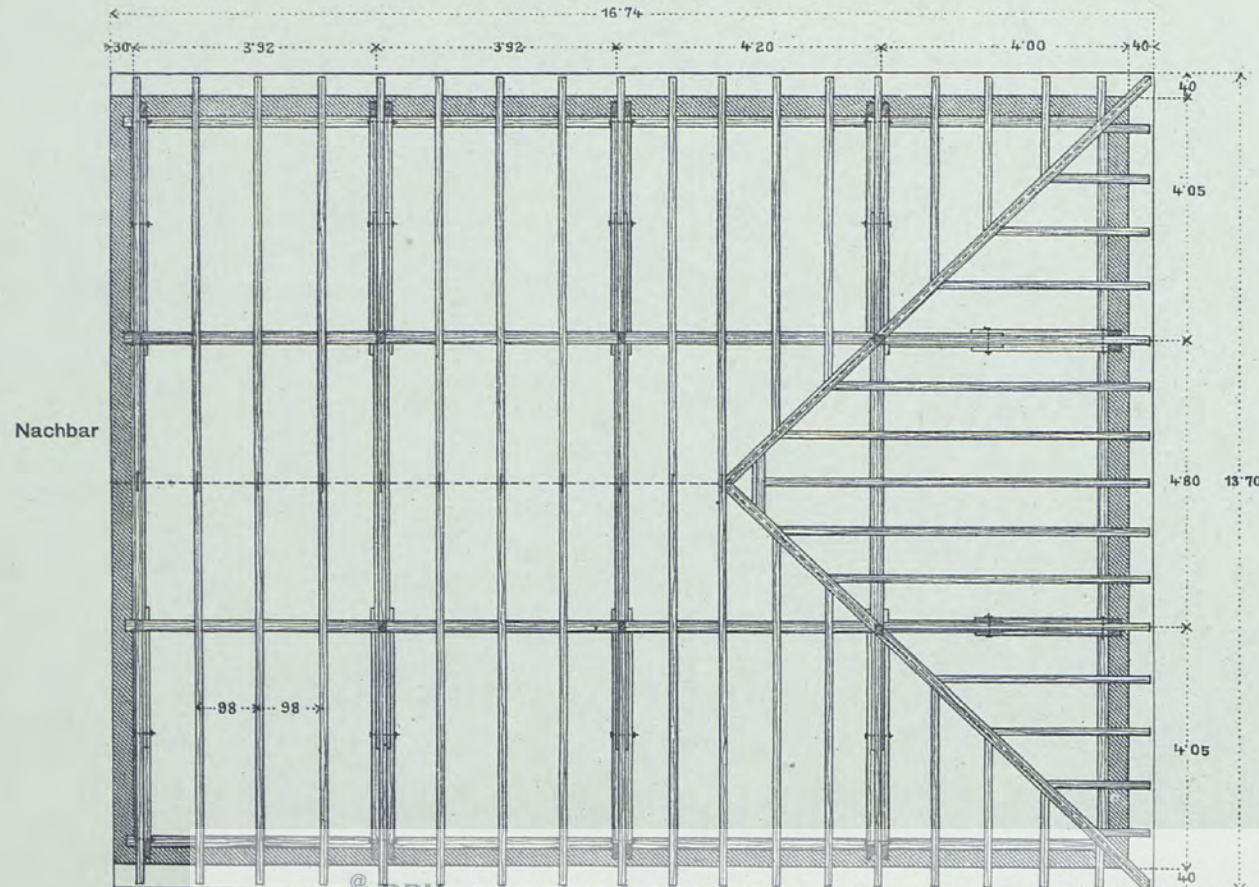

Bestimmung der Pfettenlage:
Spannweite geteilt durch 10 Teile

d. i. $\frac{12\text{ m}}{10} = \text{ein Teil } 1.2\text{ m}$
linker Teil $3 \times 1.2 = 3.6\text{ m}$
mittlerer " $4 \times 1.2 = 4.8\text{ m}$
rechter " $3 \times 1.2 = 3.6\text{ m}$

Profil 2

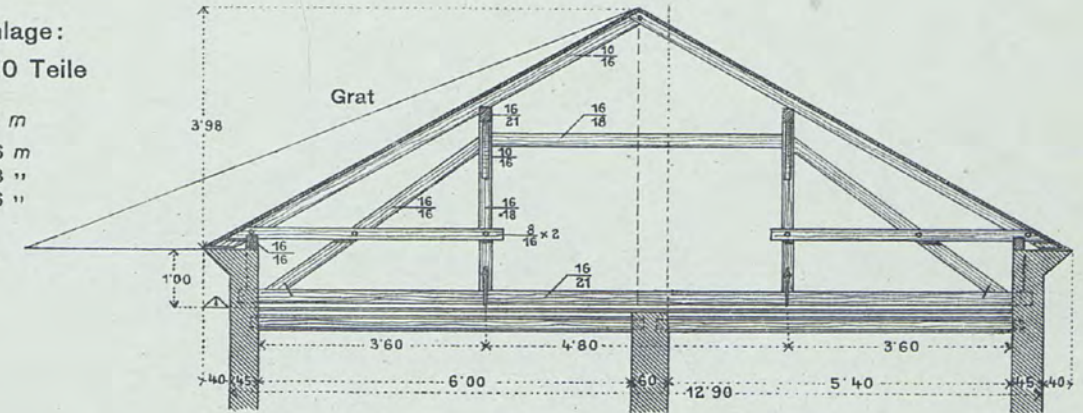

Längenschnitt 2

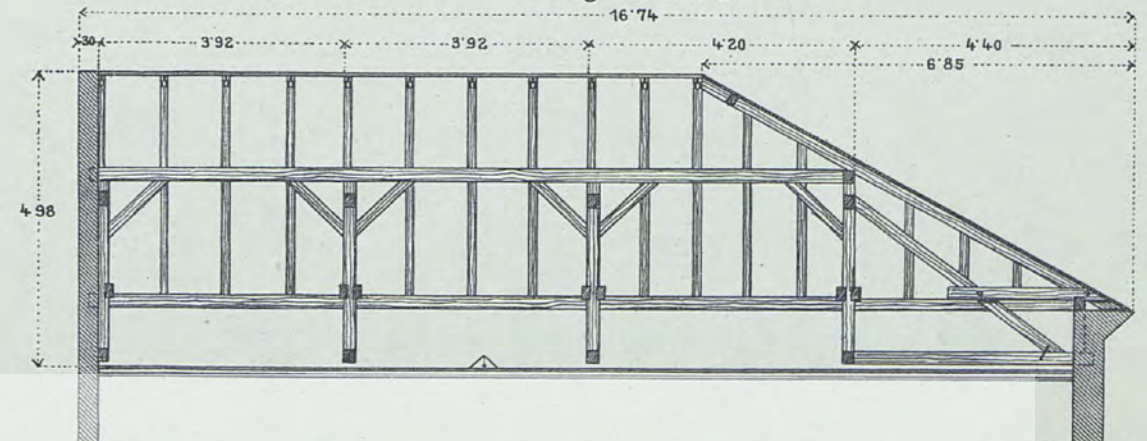

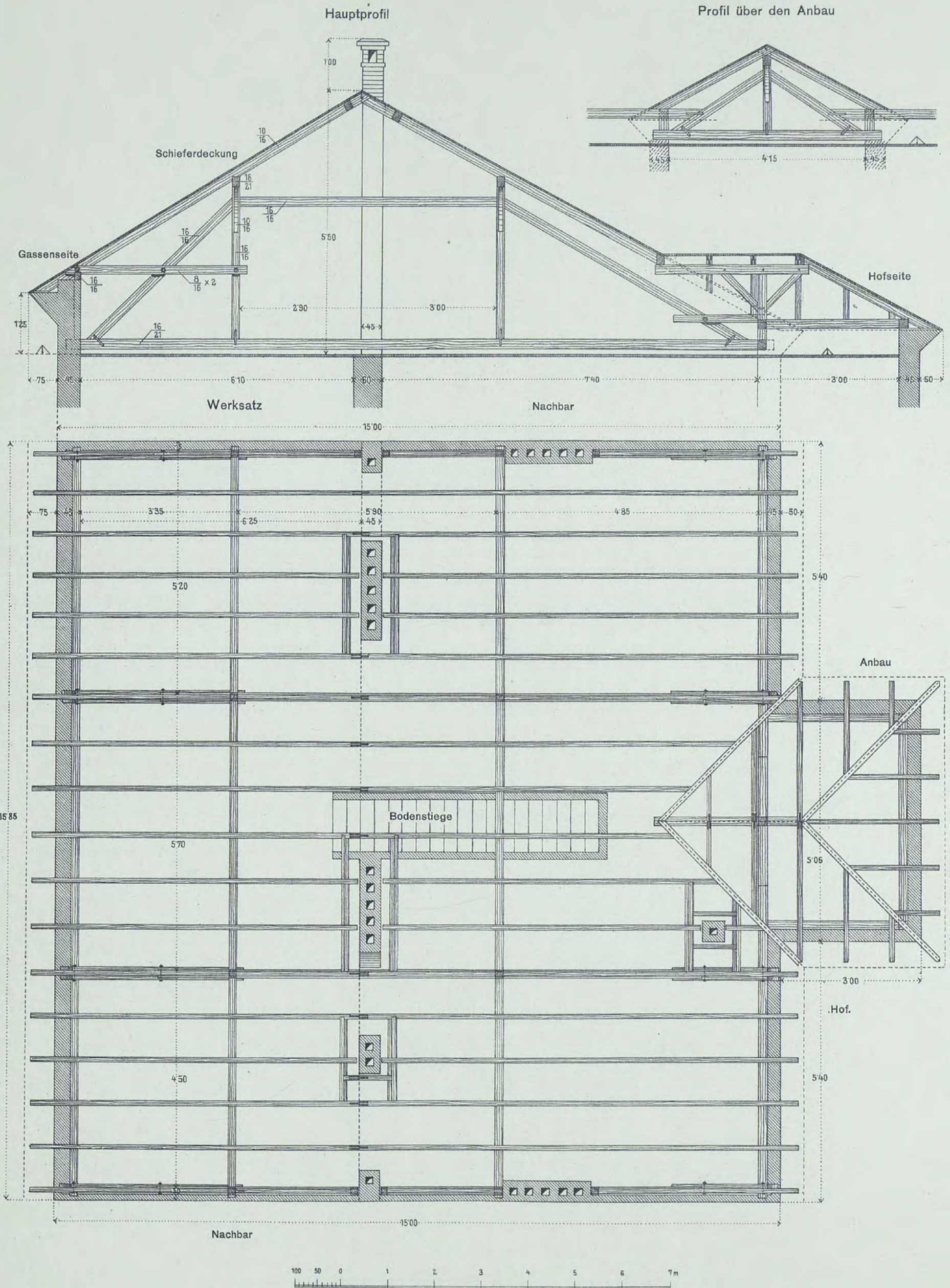

DER ZIMMERER-MEISTER, I. TEIL, Nr. 43
 WERKSATZ UND PROFIL FÜR EIN EINGEAUTES WOHNHAUS

Satteldächer mit Walm

Profil 1

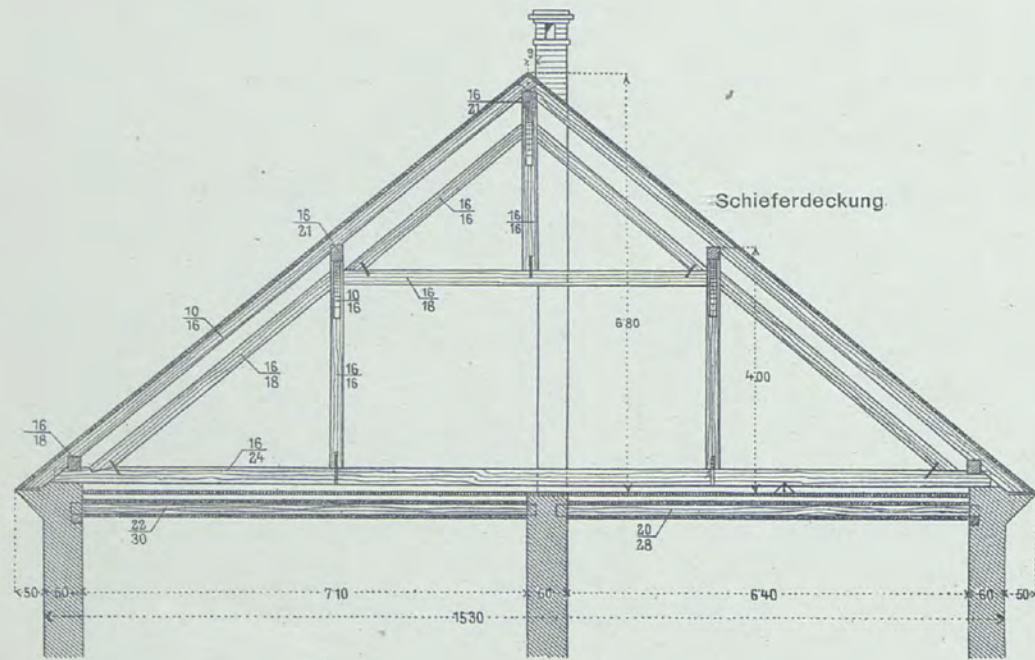

Werksatz 1



Normale winkelrechte Binderteilung

Saumdetail 2

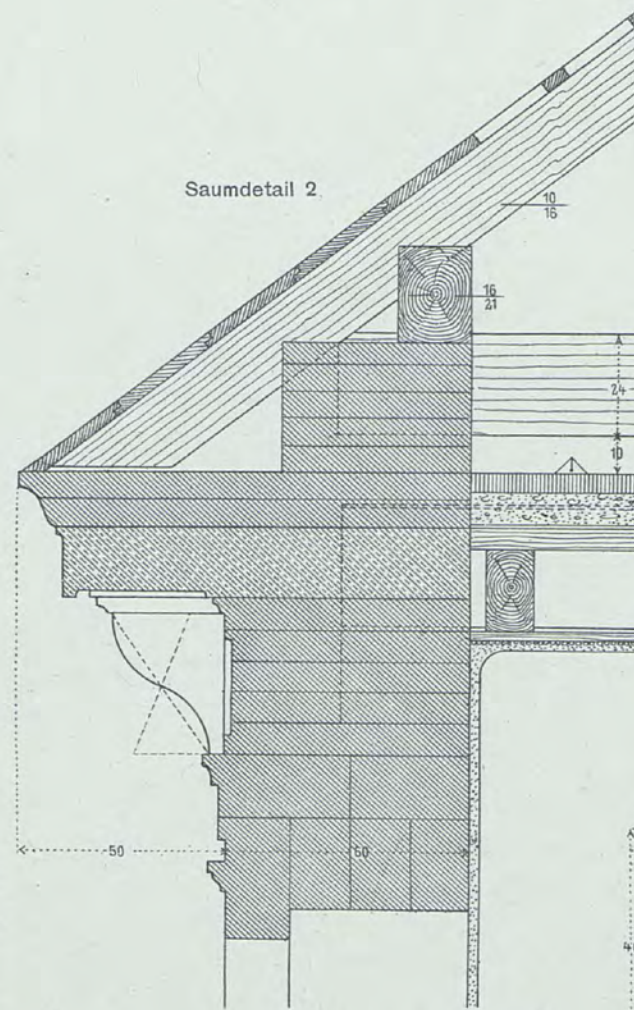

Detail

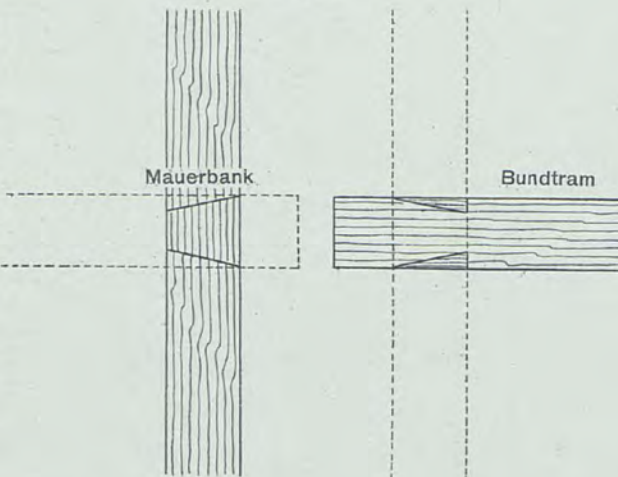

Profil 2

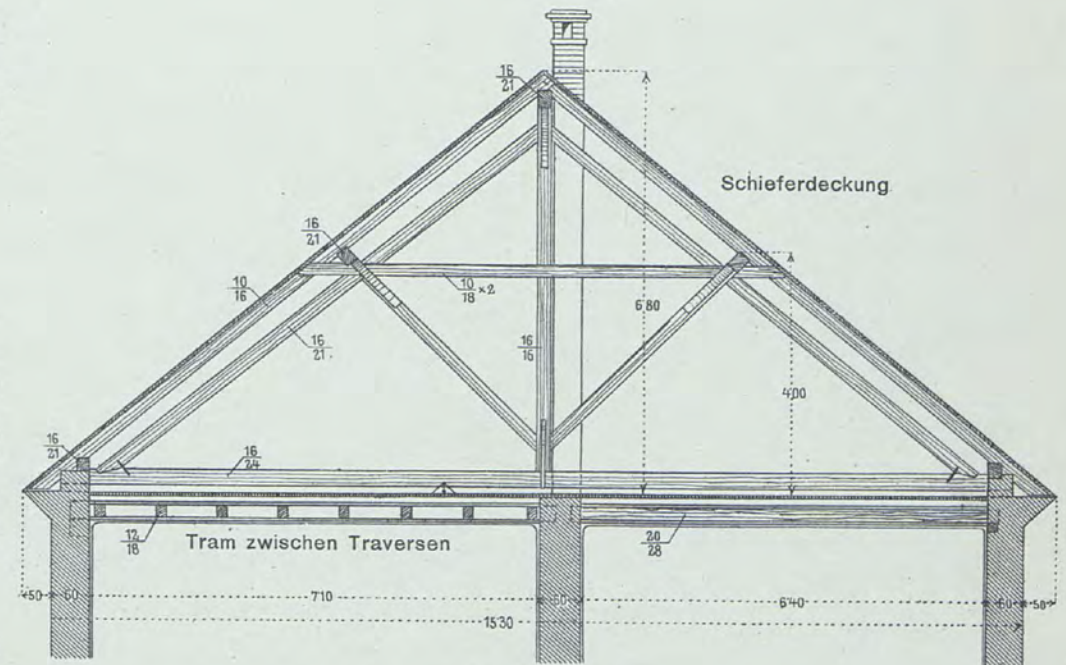

Werksatz 2



Gratbinder wegen Bockpfettenstuhl

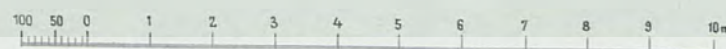

Vorderansicht

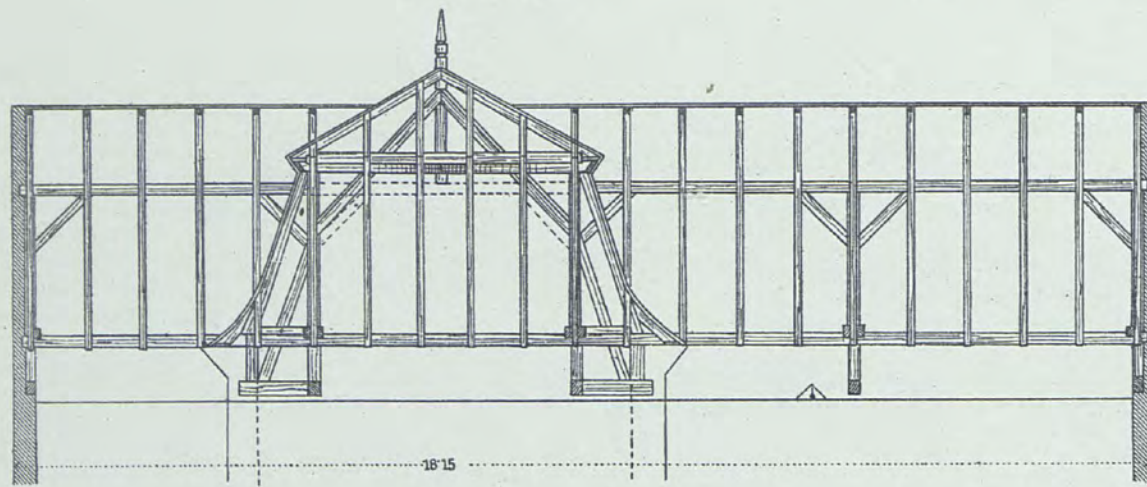

Querschnitt durch die Risalit-Mansarde

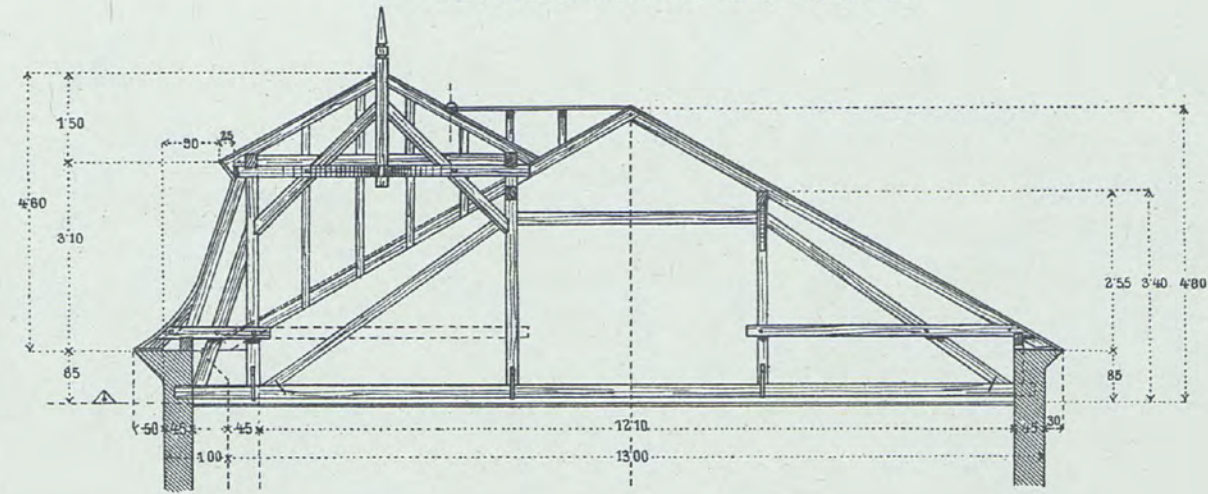

Werksatz

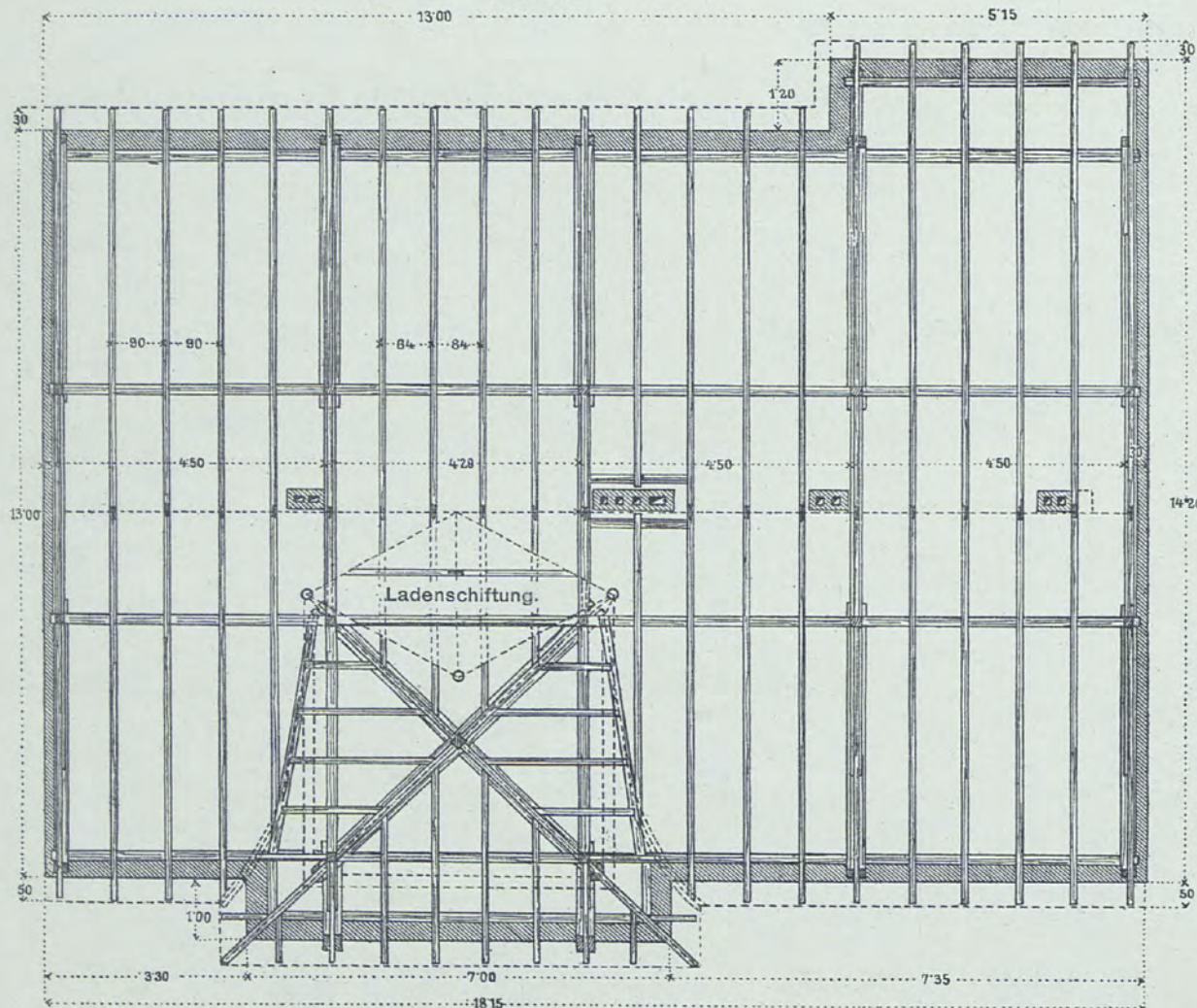

Profil

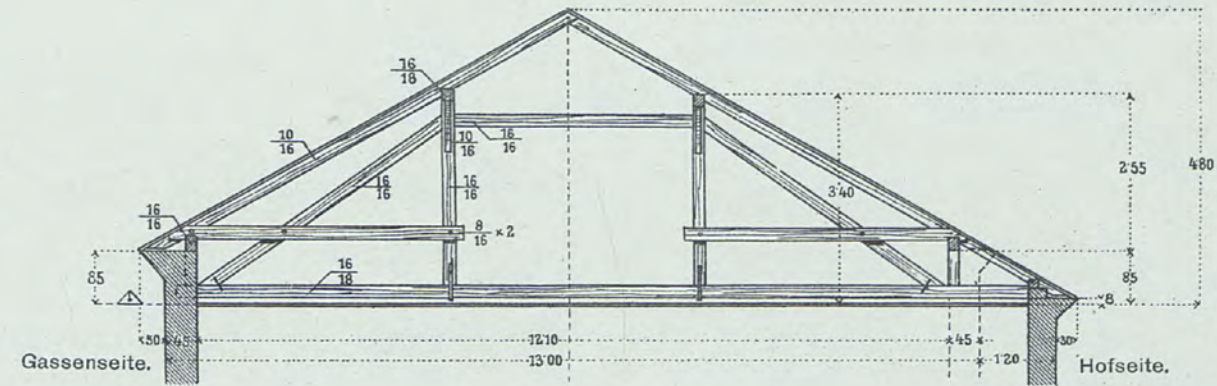

Mansardedetails

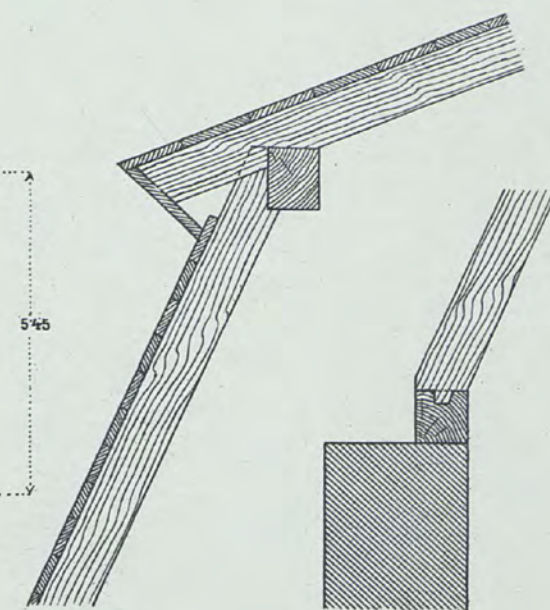

Gratprofil der Risalit-Mansarde

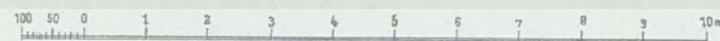
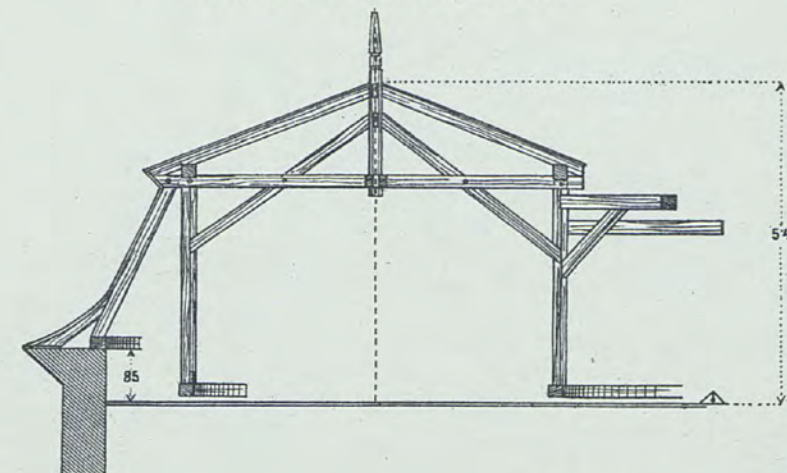

Querschnitt

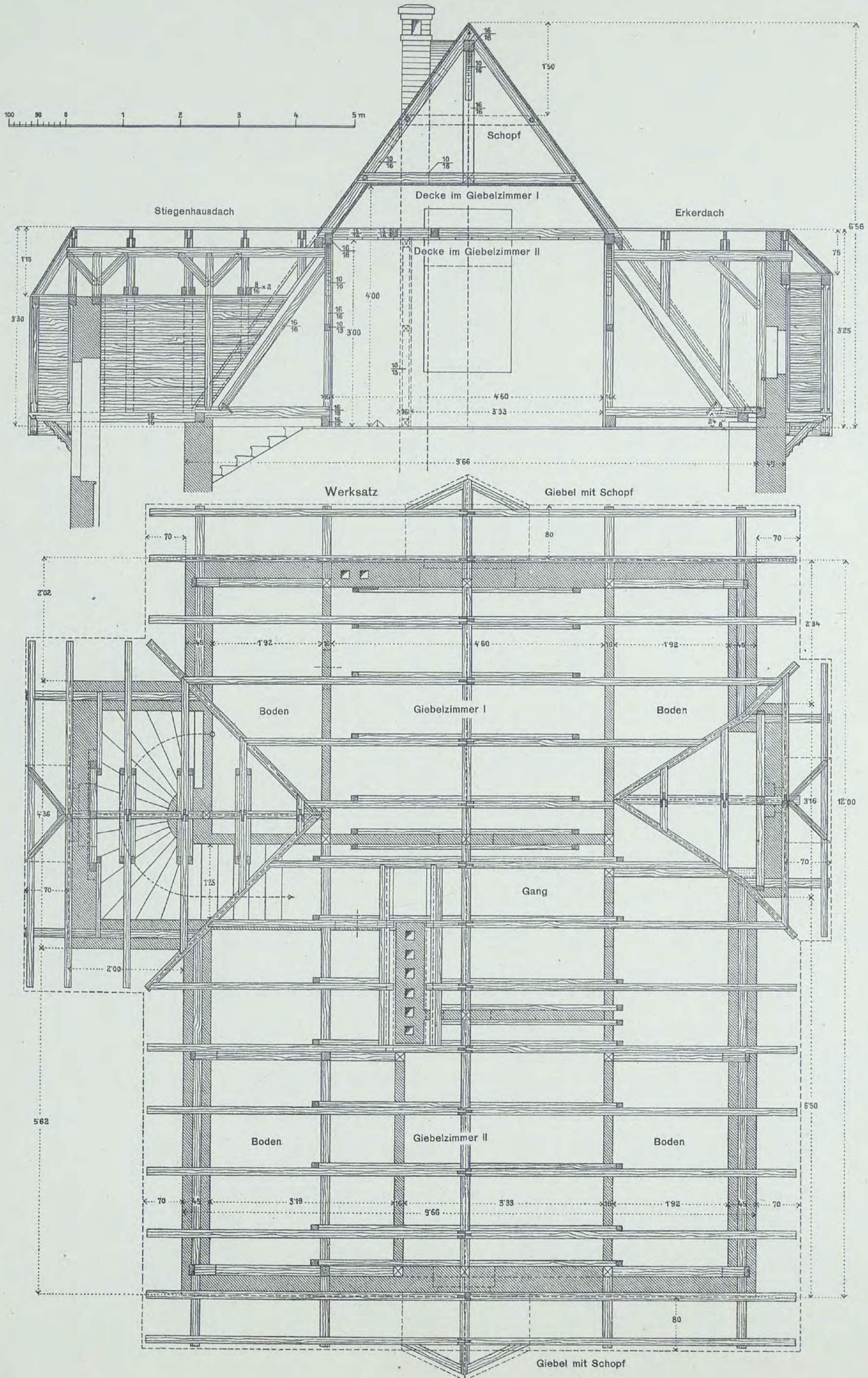

DER ZIMMERER-MEISTER, I. TEIL, Nr. 46
WERKSATZ UND PROFIL FÜR EINE VILLA.

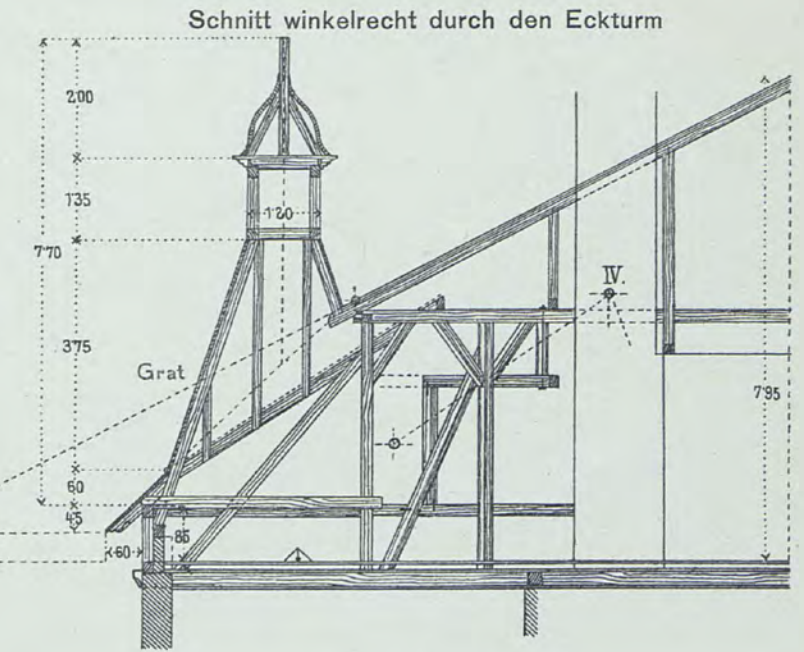
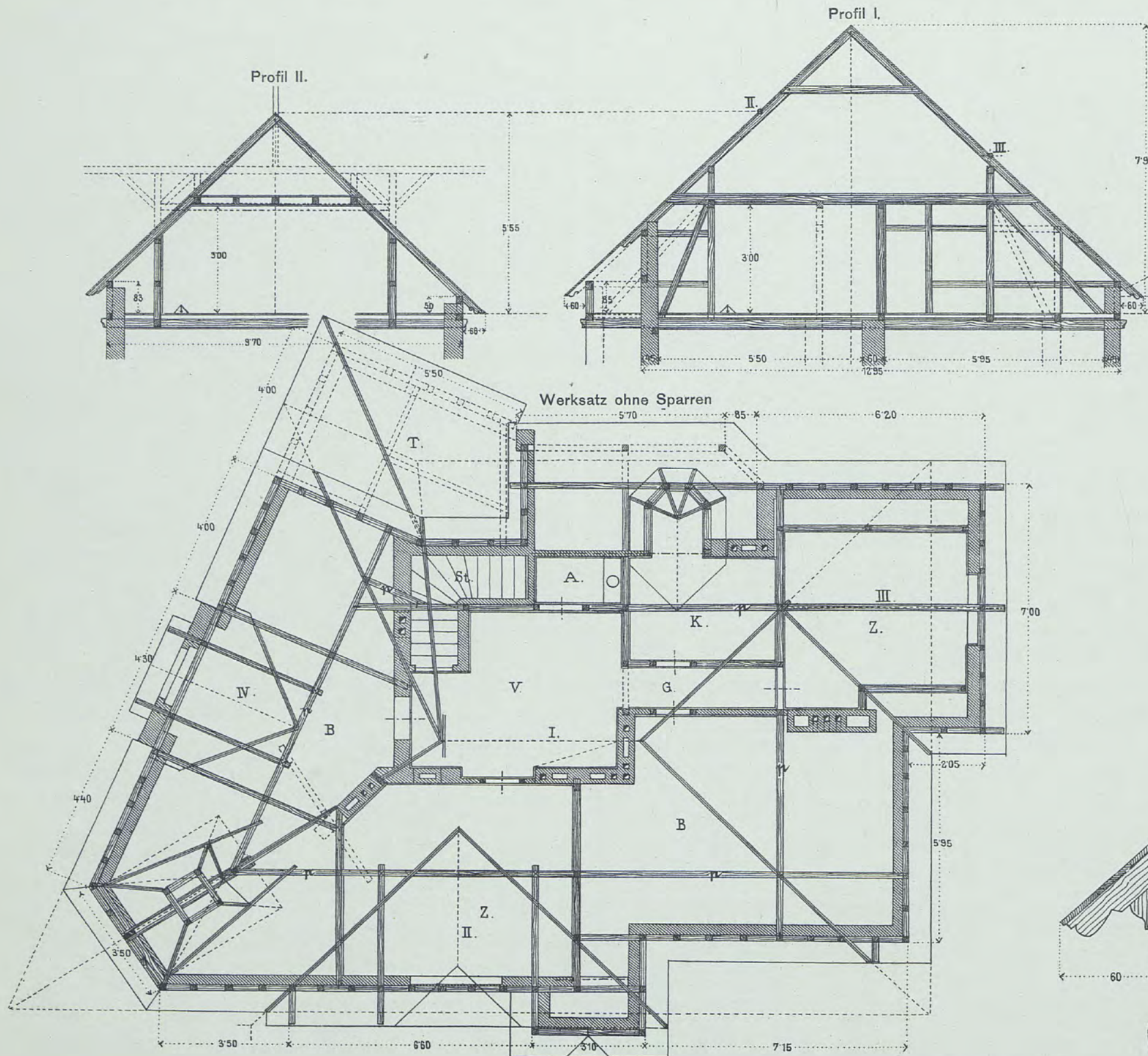

- Bezeichnungen:
- | | |
|------------------------------|------------------|
| T. = tiefer gelegener Anbau. | K. = Kammer. |
| A. = Abort. | G. = Gang. |
| St. = Bodenstiege. | Z. = Dachzimmer. |
| V. = Vorraum. | B. = Bodenraum. |
| | p. = Pfette. |

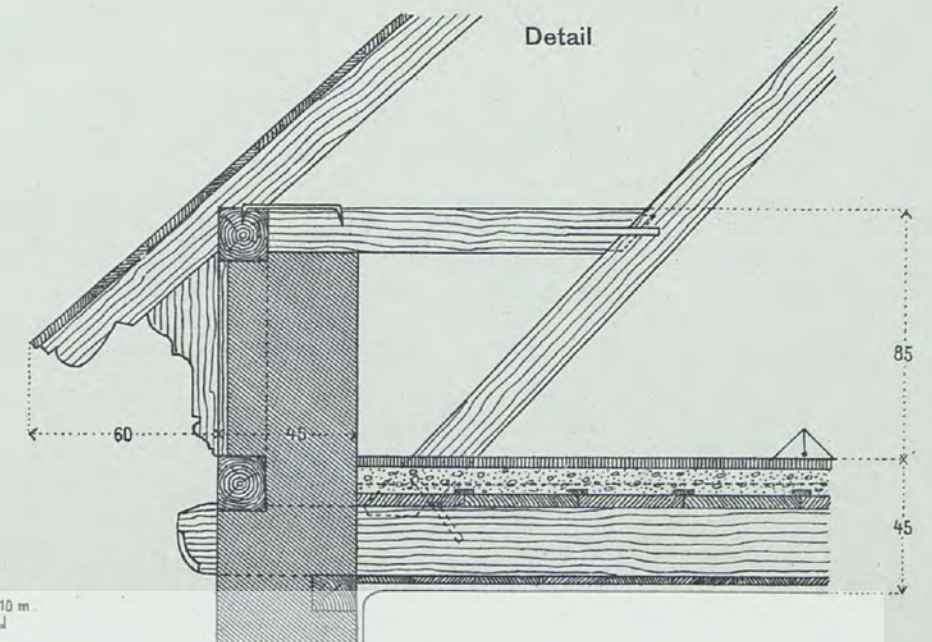
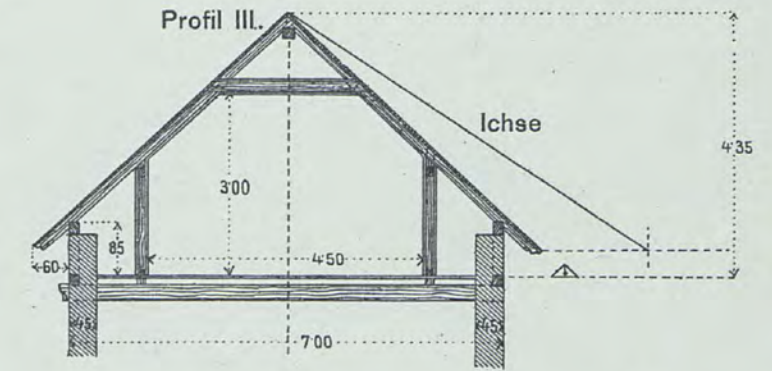

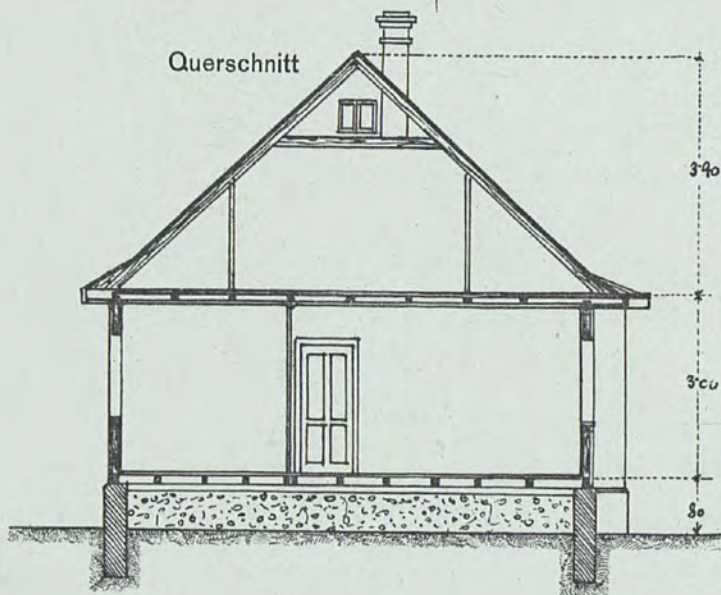
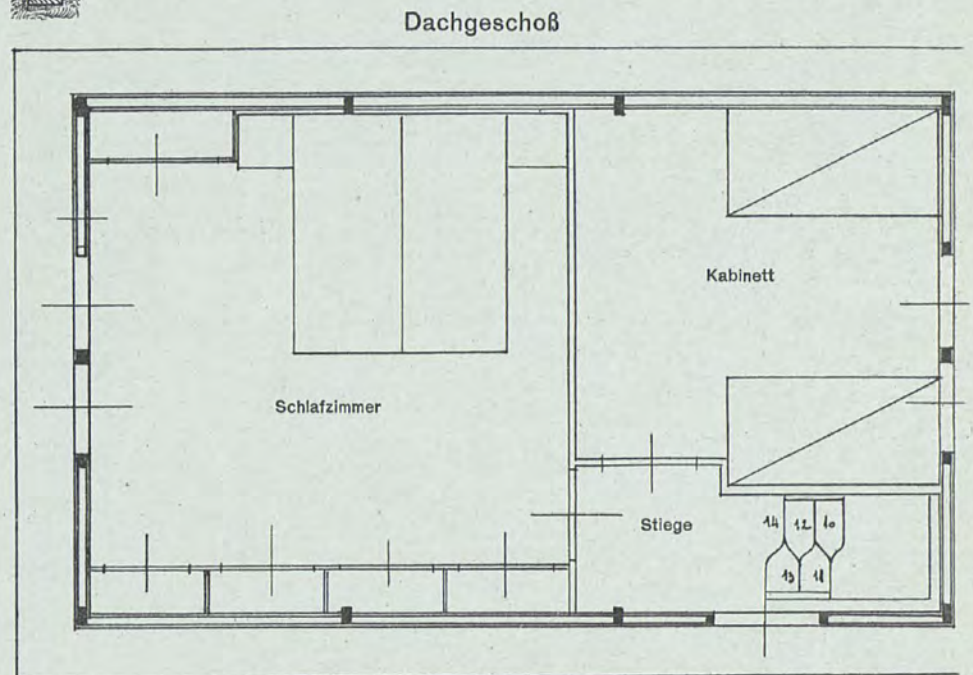
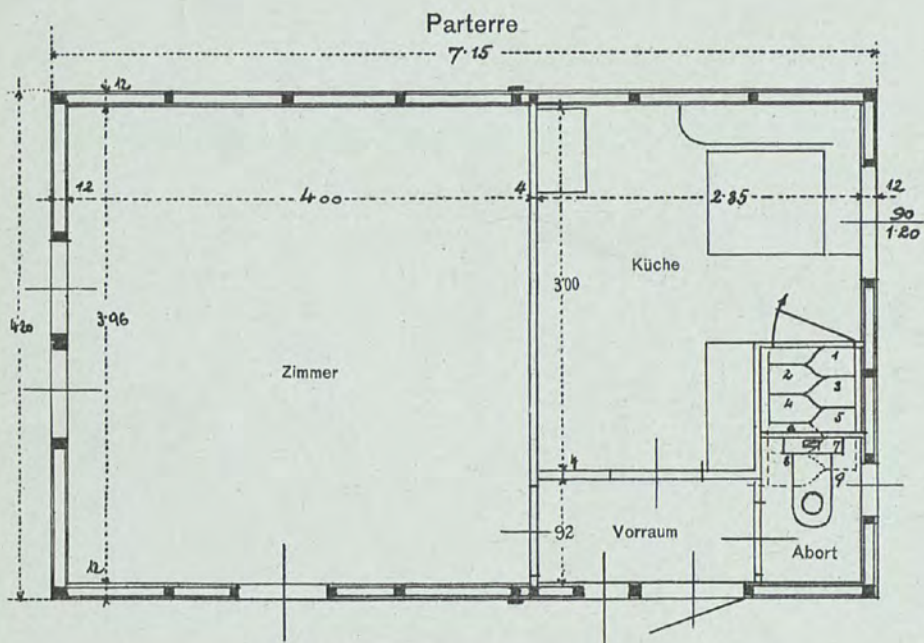
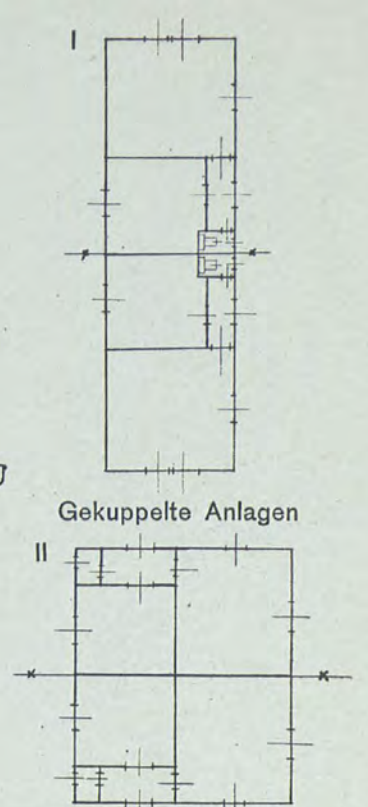
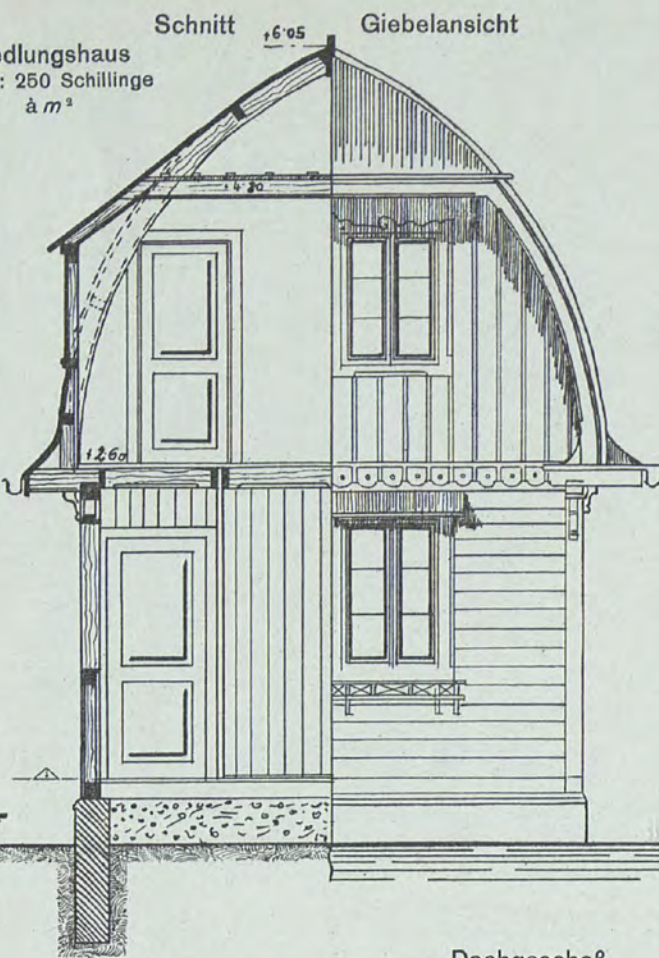
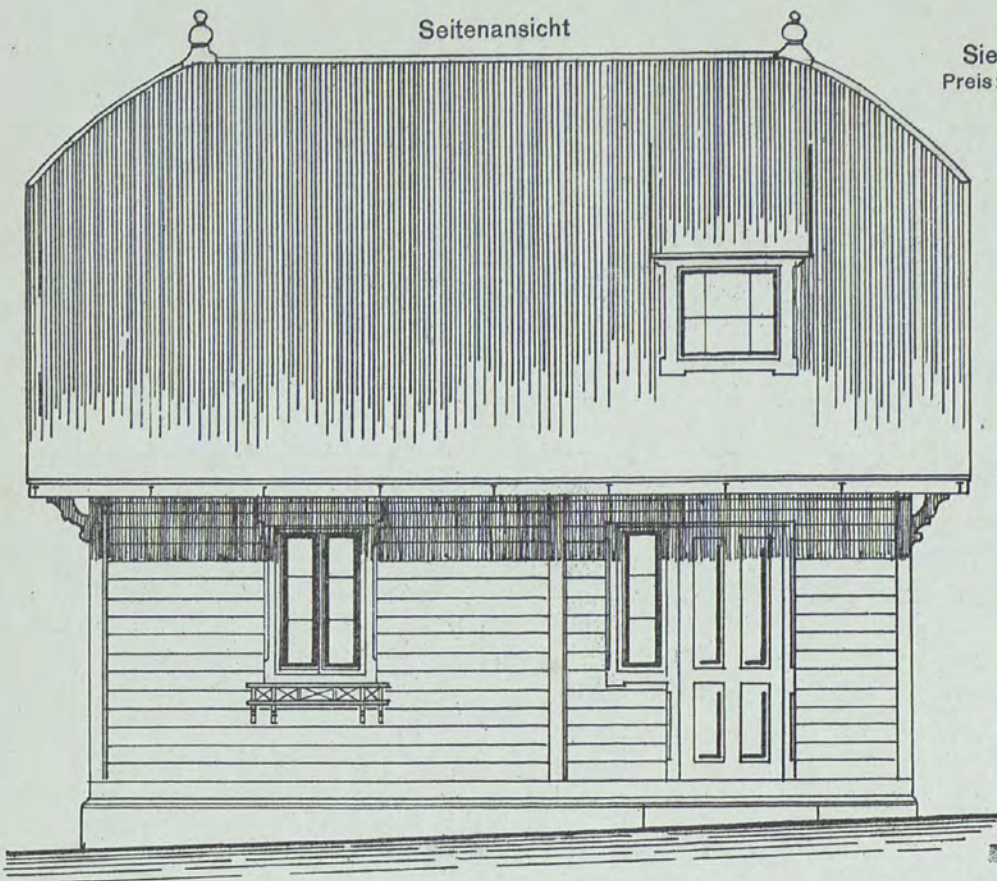

Siedlungshaus
 Preis: 280 Schillinge
 à m²

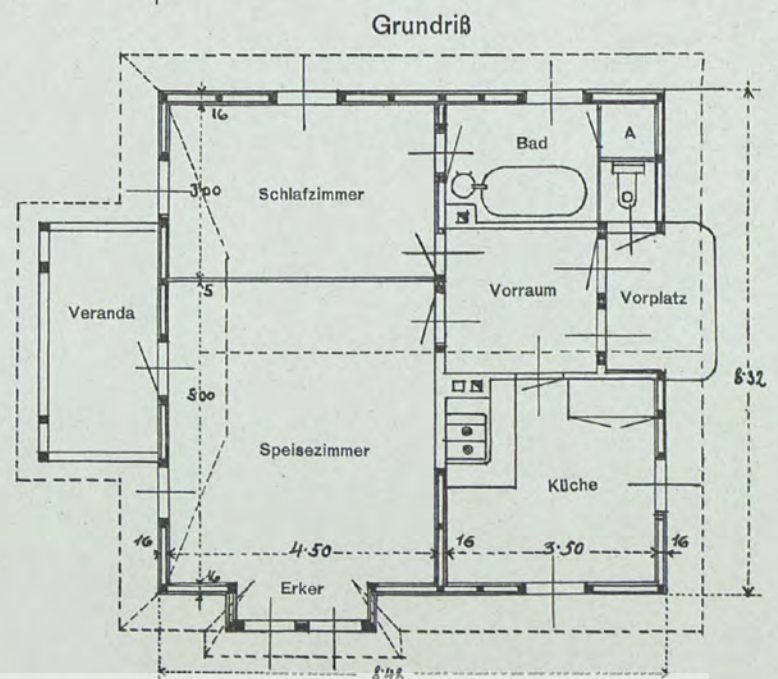
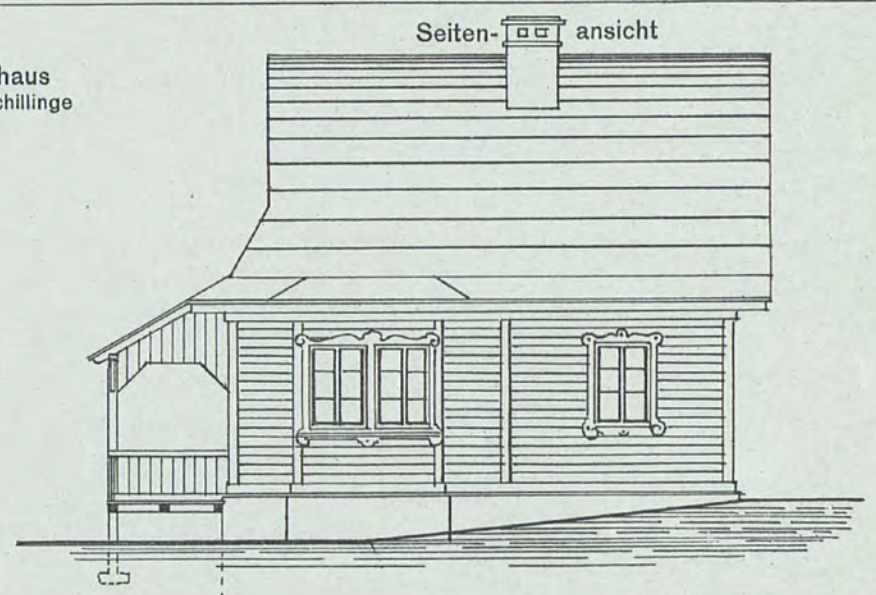

DER ZIMMERER-MEISTER, I. TEIL, Nr. 48
 SIEDLUNGS- UND LANDHÄUSER MIT SYSTEM „IBA-ZENZ“

DER ZIMMERERMEISTER, I. TEIL, Nr. 49

SIEDLUNGS- UND LANDHÄUSER MIT SYSTEM „STEPHAN“

Entwurf: } Österr. Stephans-Dachgesellschaft,
Ausführung: } Wien XIII

Professor und Stadtzimmermeister
A. BAUDOUIN, Wien

6000 bis 7000 Schillinge

Schaubild



Ansicht

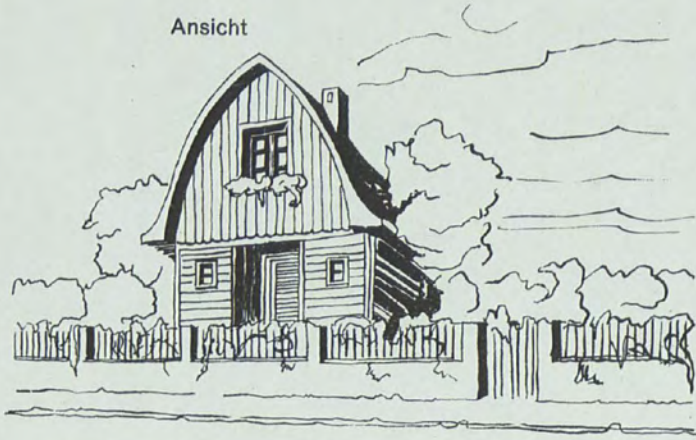

Schaubild

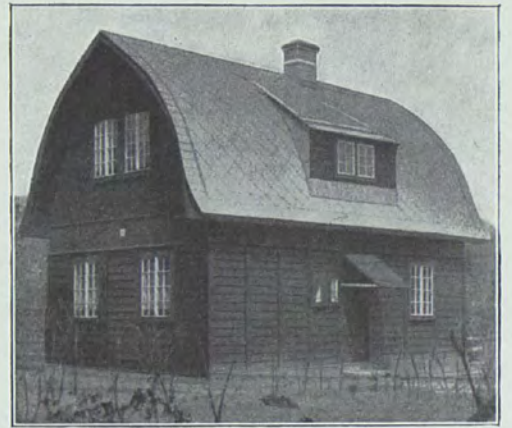

Ebenererd

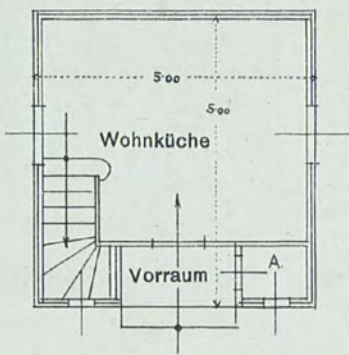

Ebenererd Alternativ

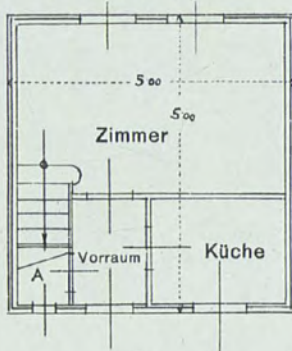

Dachgeschoß

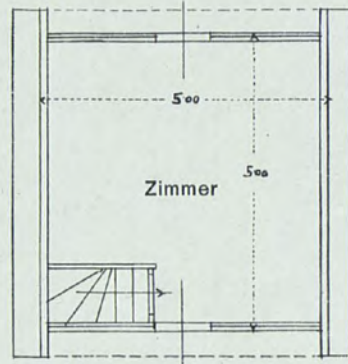

12.000 bis 14.000 Schillinge

Schaubild

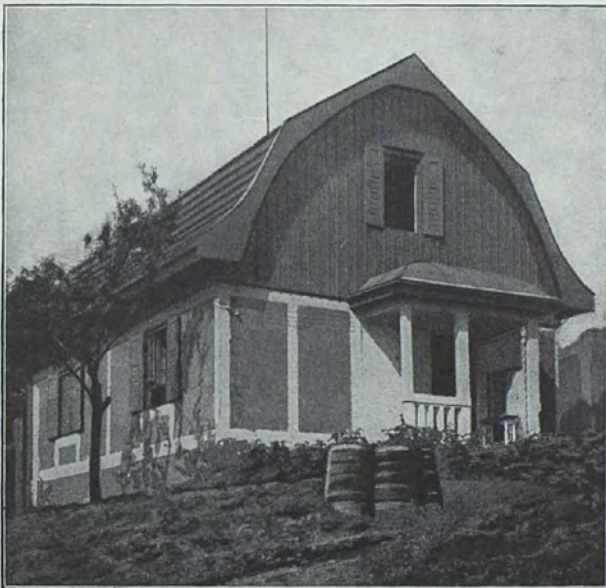

Ansicht

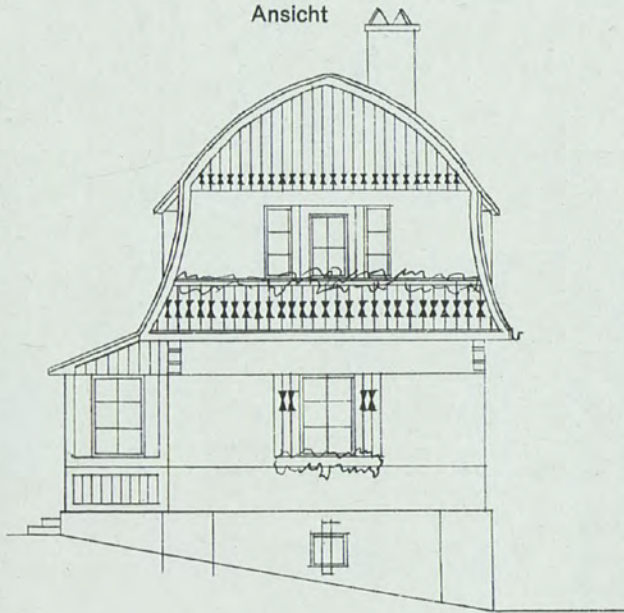

Schaubild

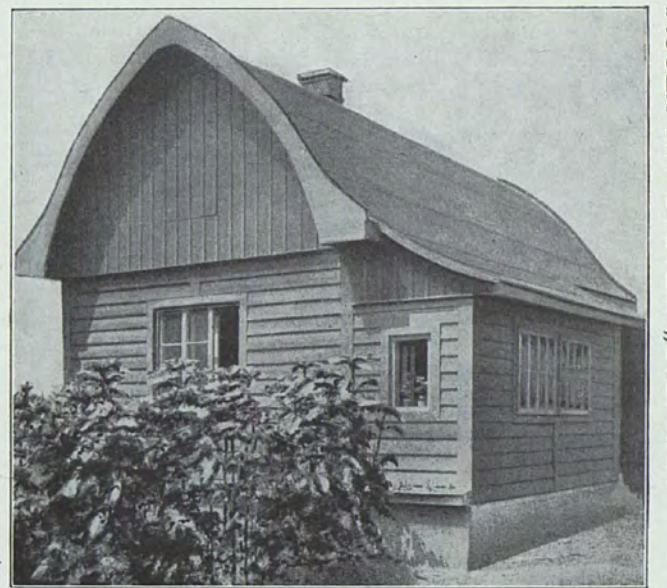

Ebenererd

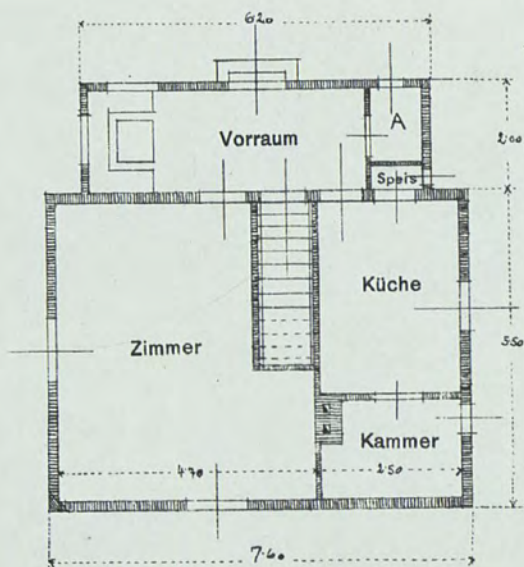

Dachgeschoß

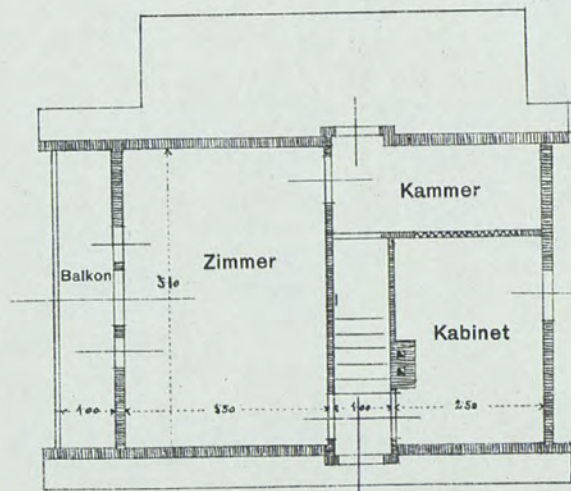

DER ZIMMERERMEISTER, I. TEIL, Nr. 49
SIEDLUNGS- UND LANDHÄUSER MIT SYSTEM „STEPHAN“

Schaubilder

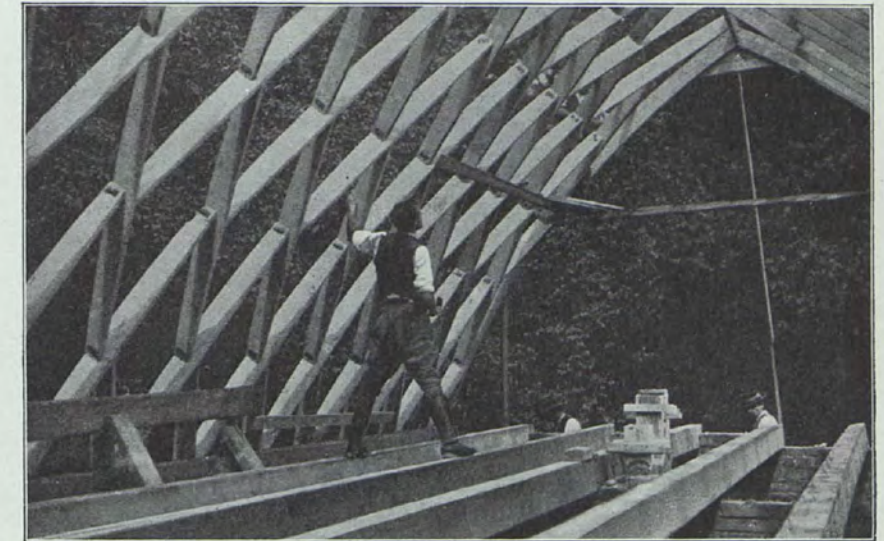
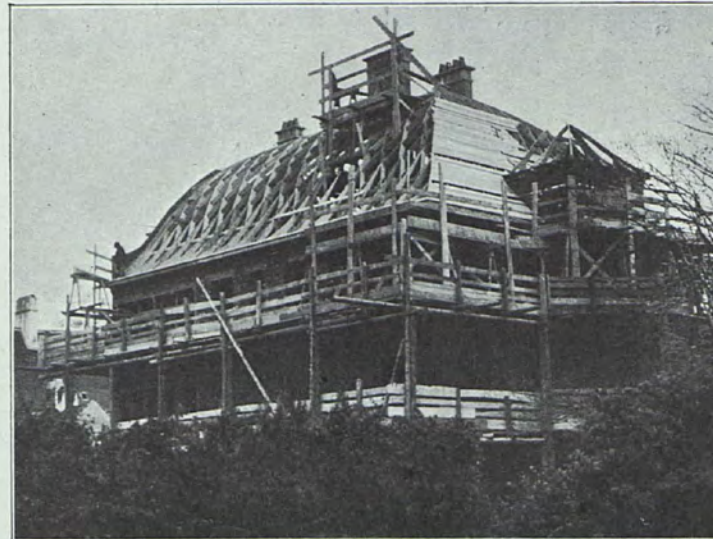
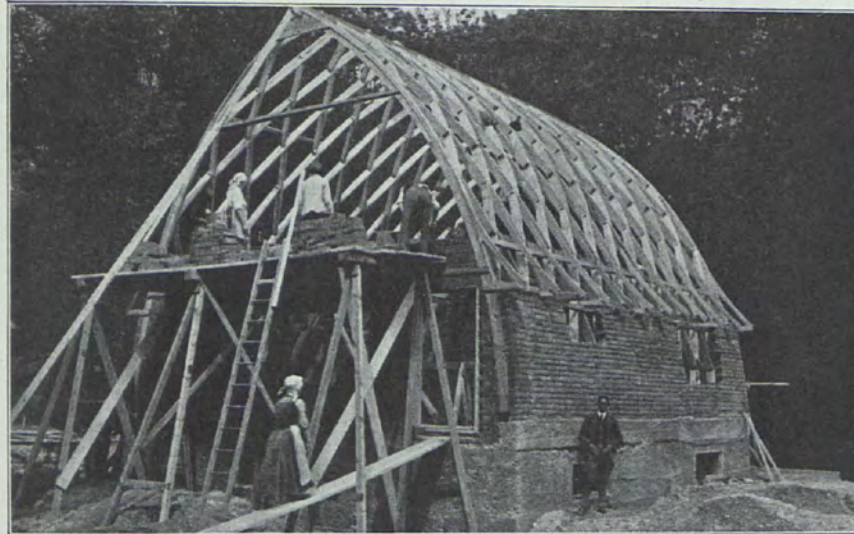

Schaubilder

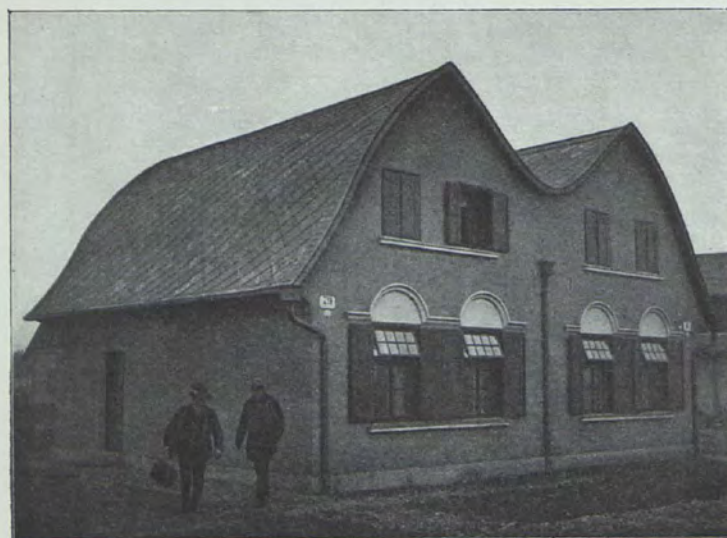

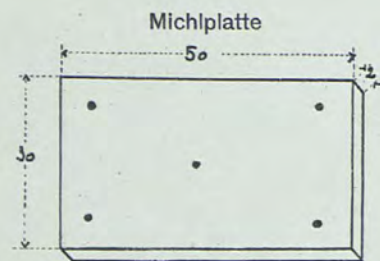

Die Michlplatten-Bauweise besteht aus innen und außen rau verschalten oder verlatteten Riegelwänden auf lärchenen Schwellen und innerer sowie äußerer Verkleidung mit „Michlplatten“.

Dieselben bestehen aus imprägniertem Holzstoff 30 auf 50 cm groß, 2 cm stark, entsprechen den höchsten Ansprüchen an Wärmehaltung, sind feuersicher, wasserunempfindlich, leicht zu bearbeiten und besitzen ein geringes Eigengewicht. Die Platten wiegen

per Quadratmeter 7.5 bis 8 kg; im verputzten Zustand wiegt ein Quadratmeter 14 kg. Der Verputz findet in den Rillen der Platte seinen Halt.

Die Platten werden in viererlei Typen hergestellt und je nach Bedarf verwendet.

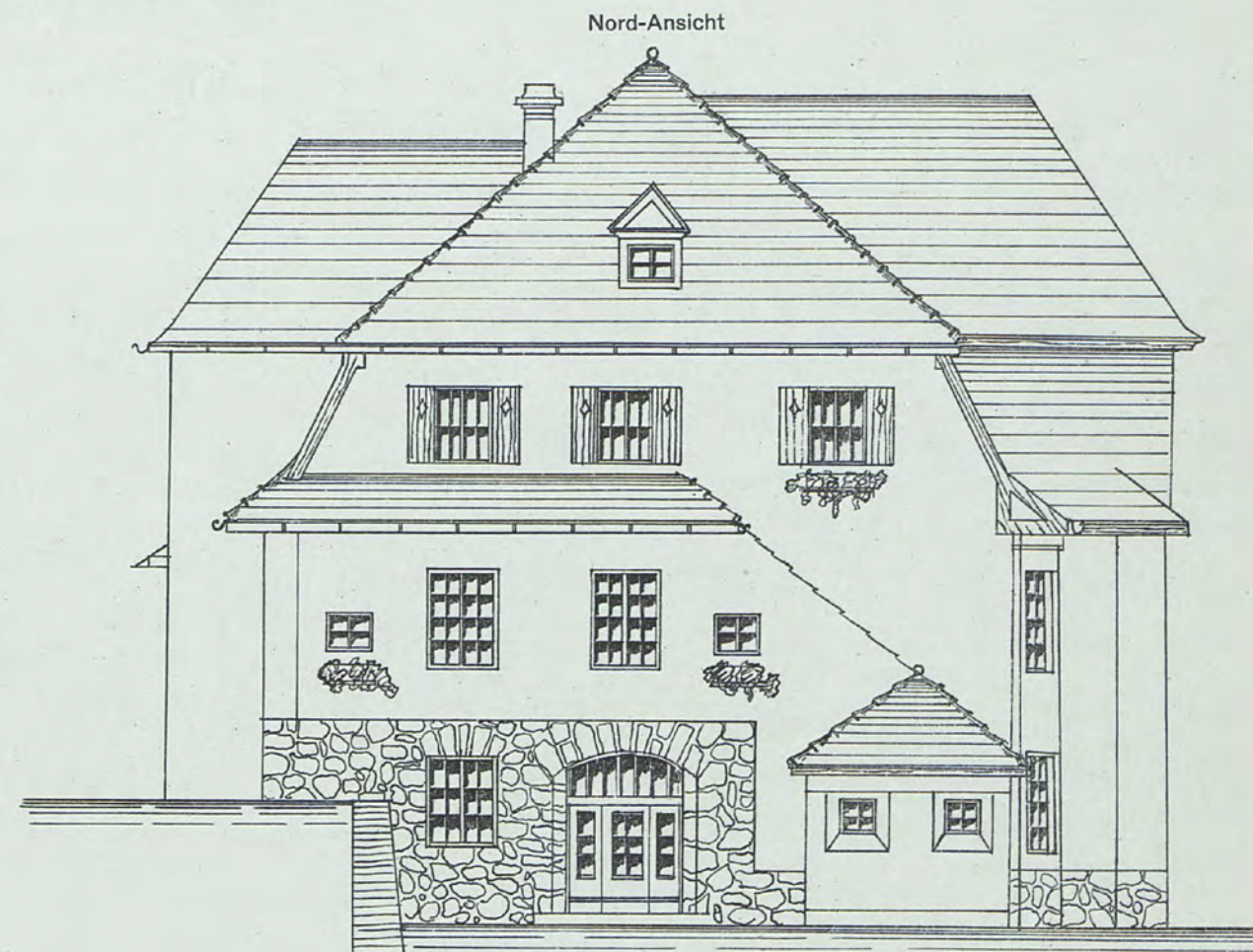
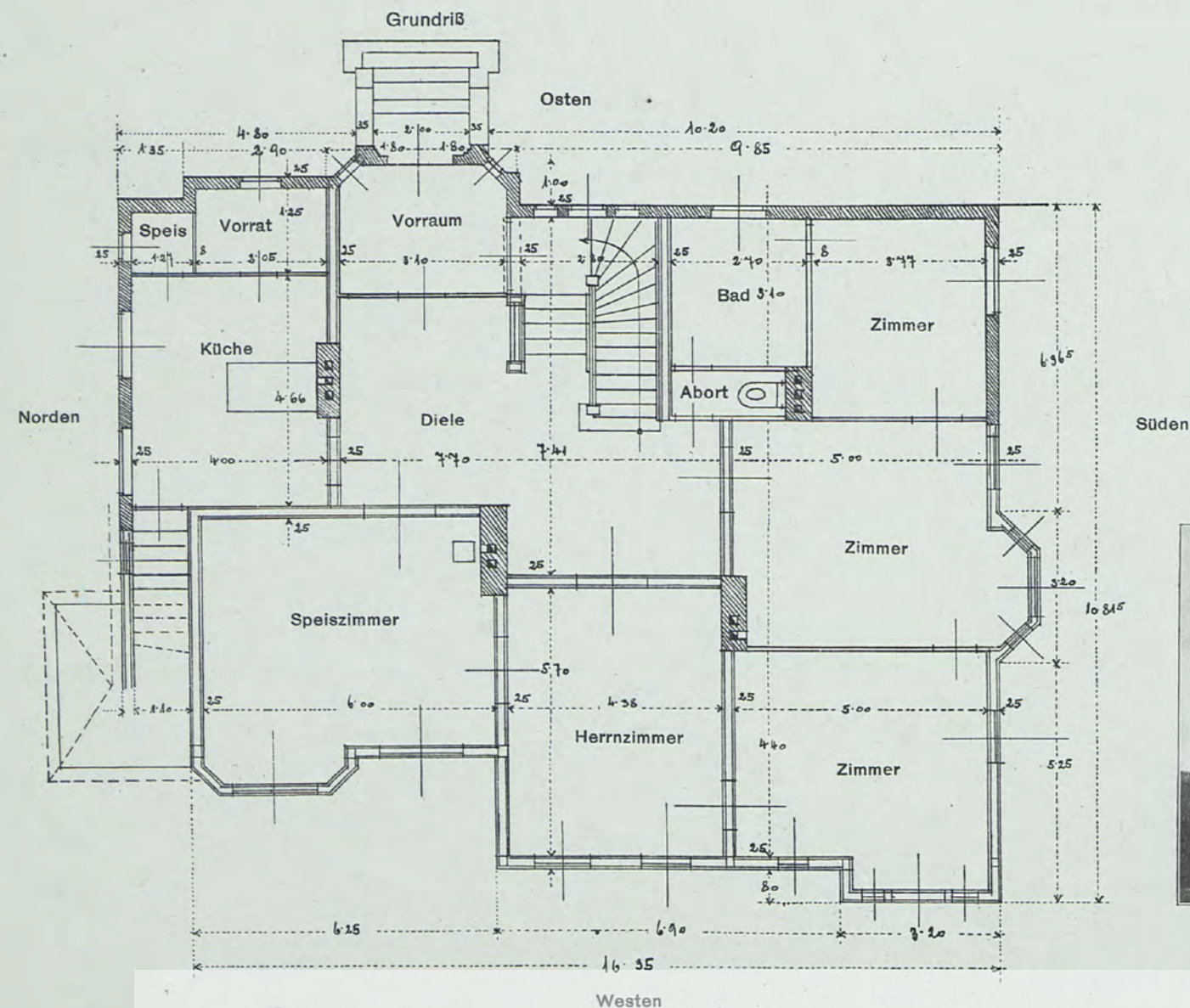

Schaubilder

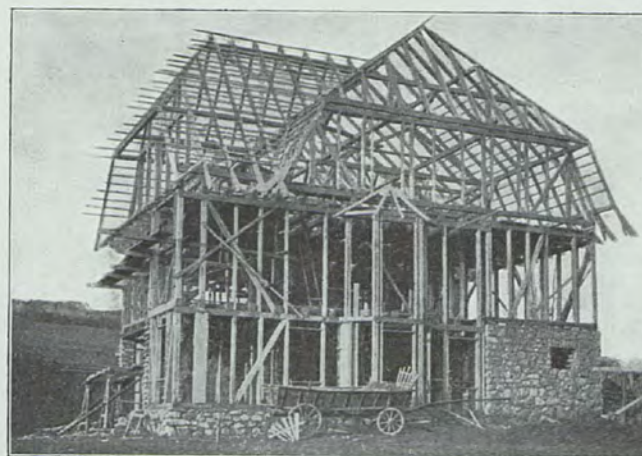

Vorderansicht

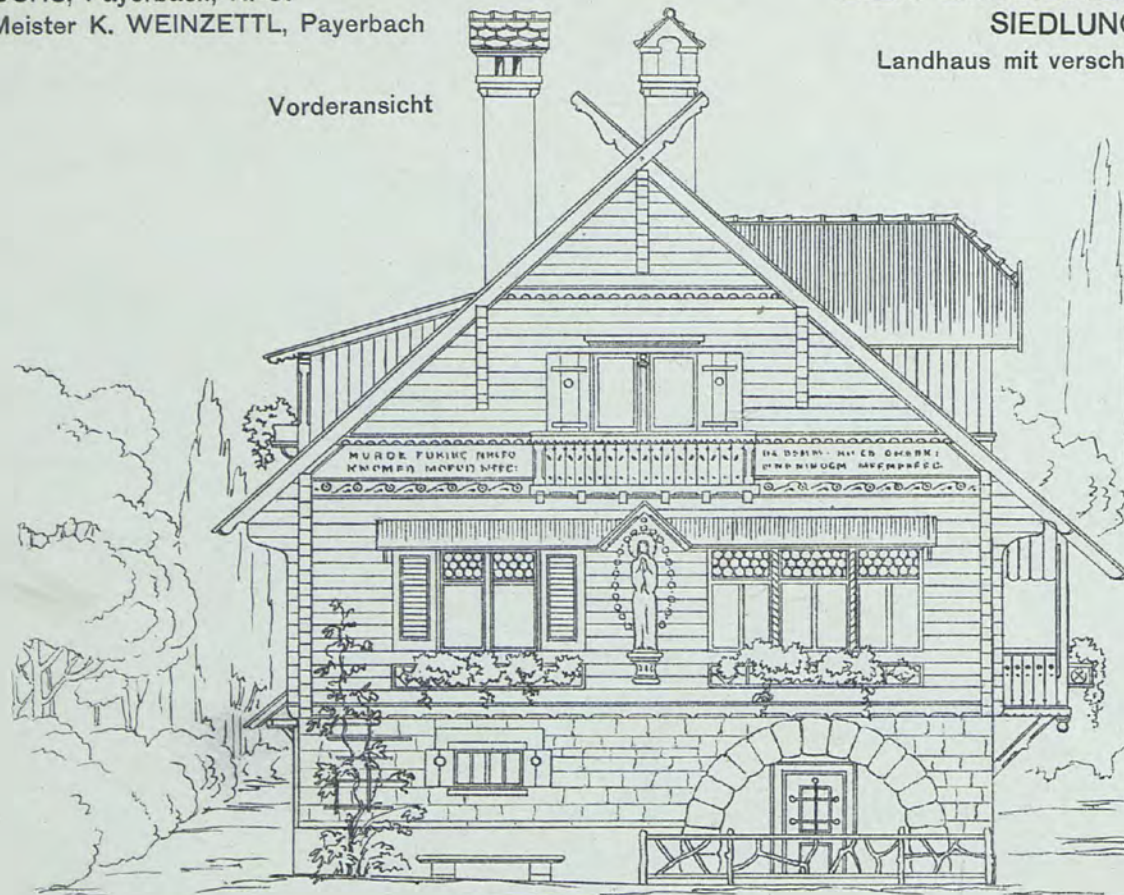

Seitenansicht

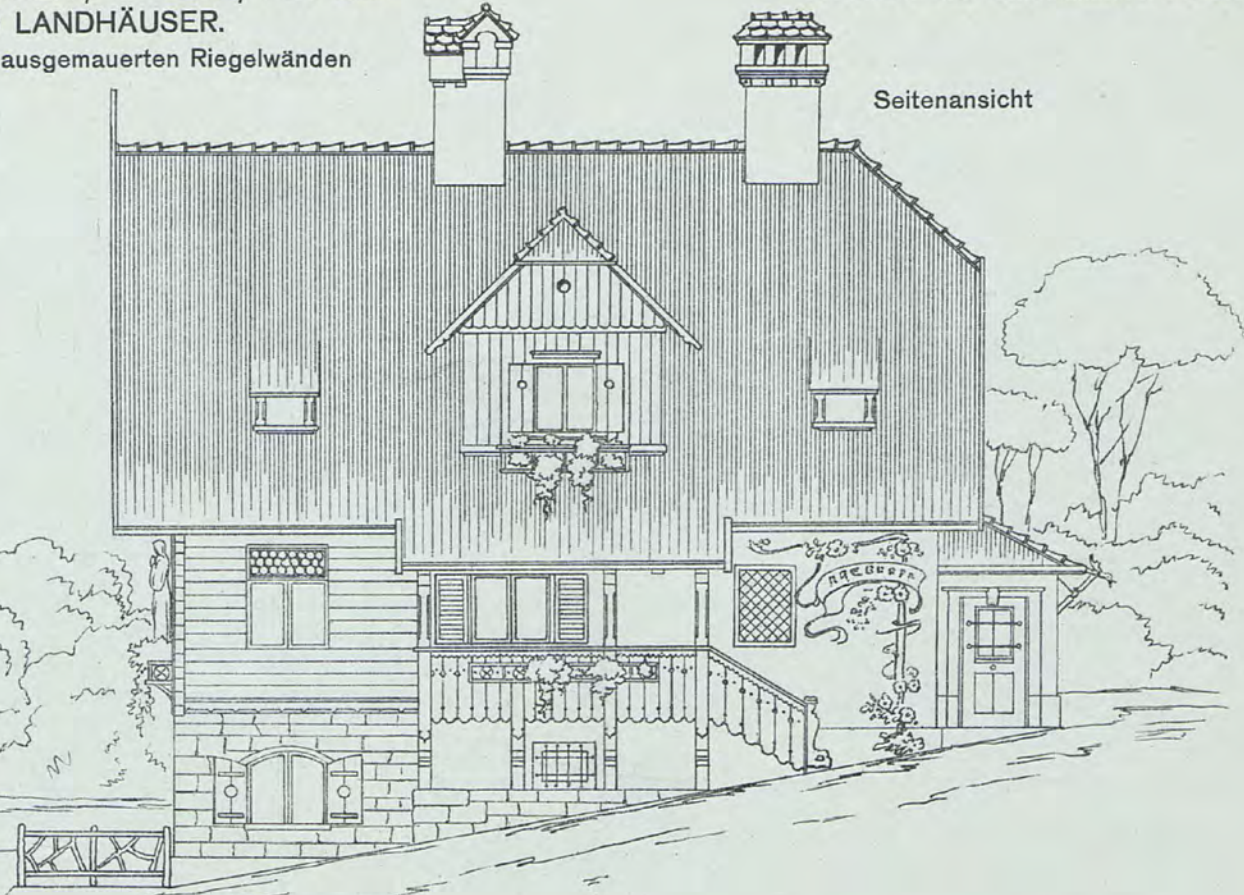

Parterre

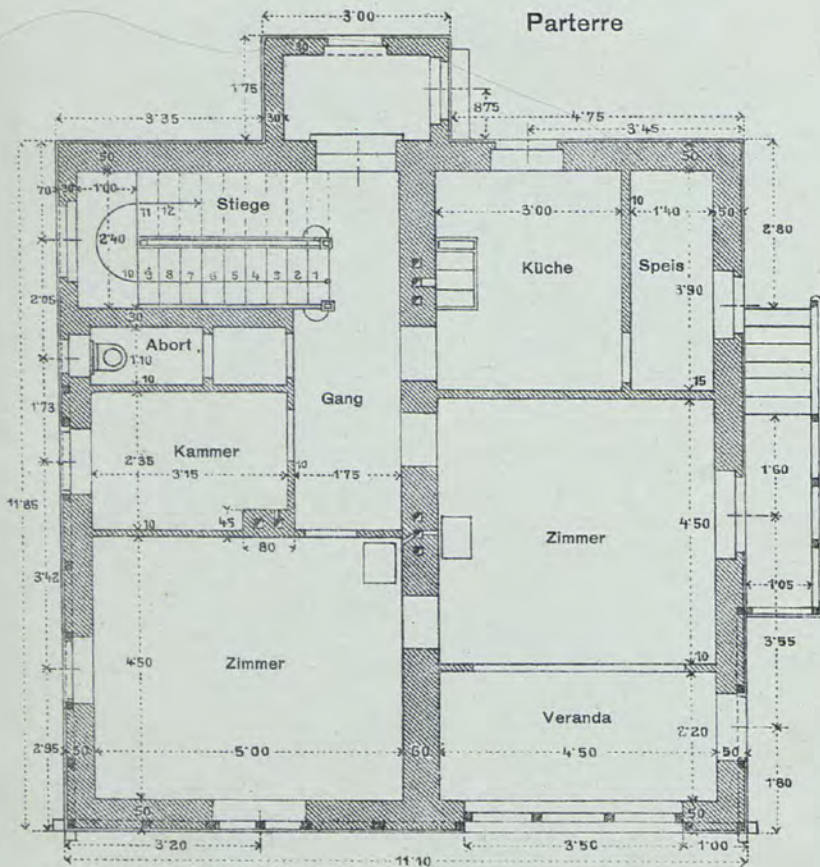

Dachboden

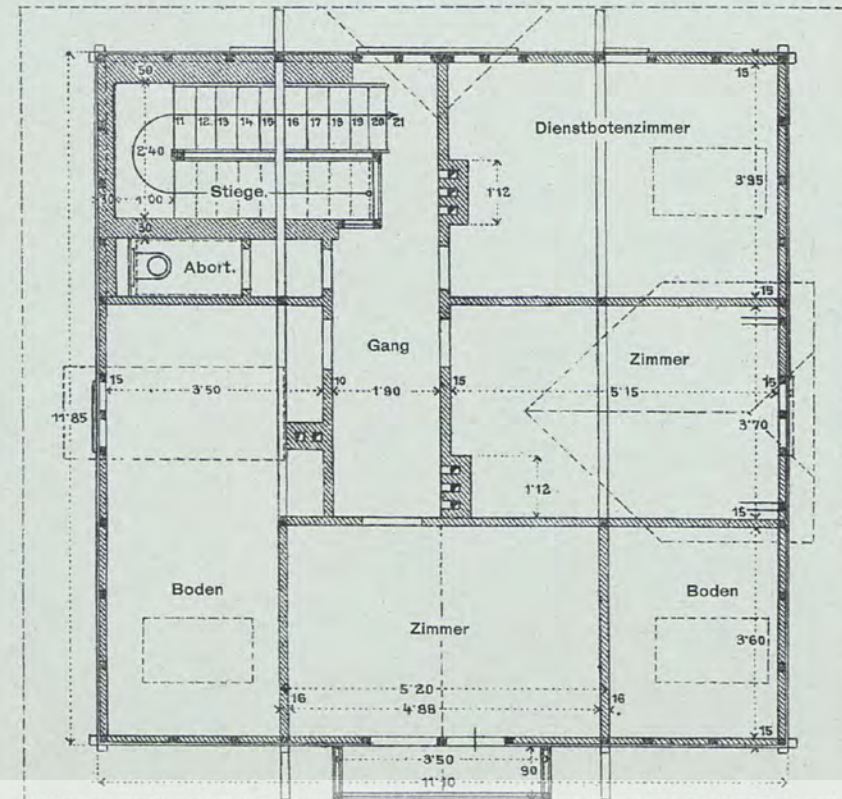

Querschnitt

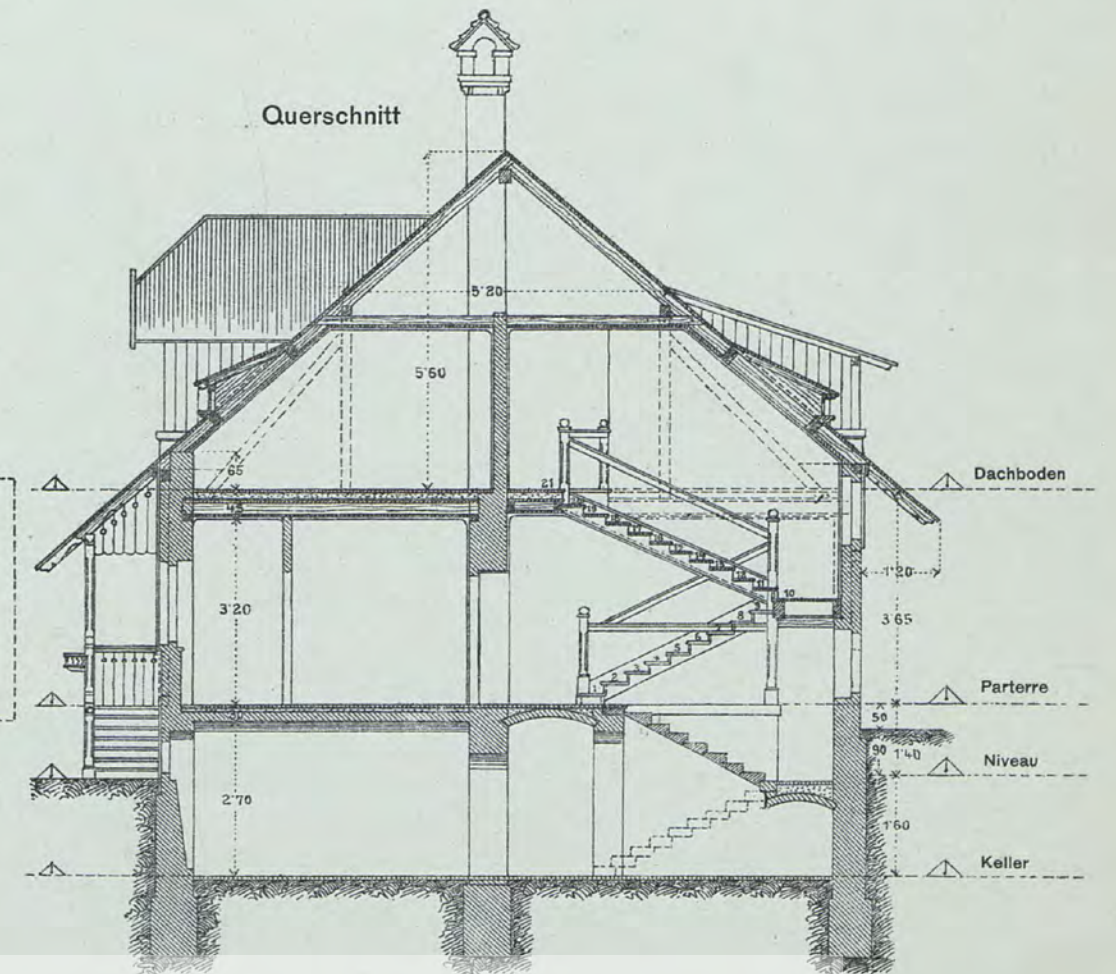

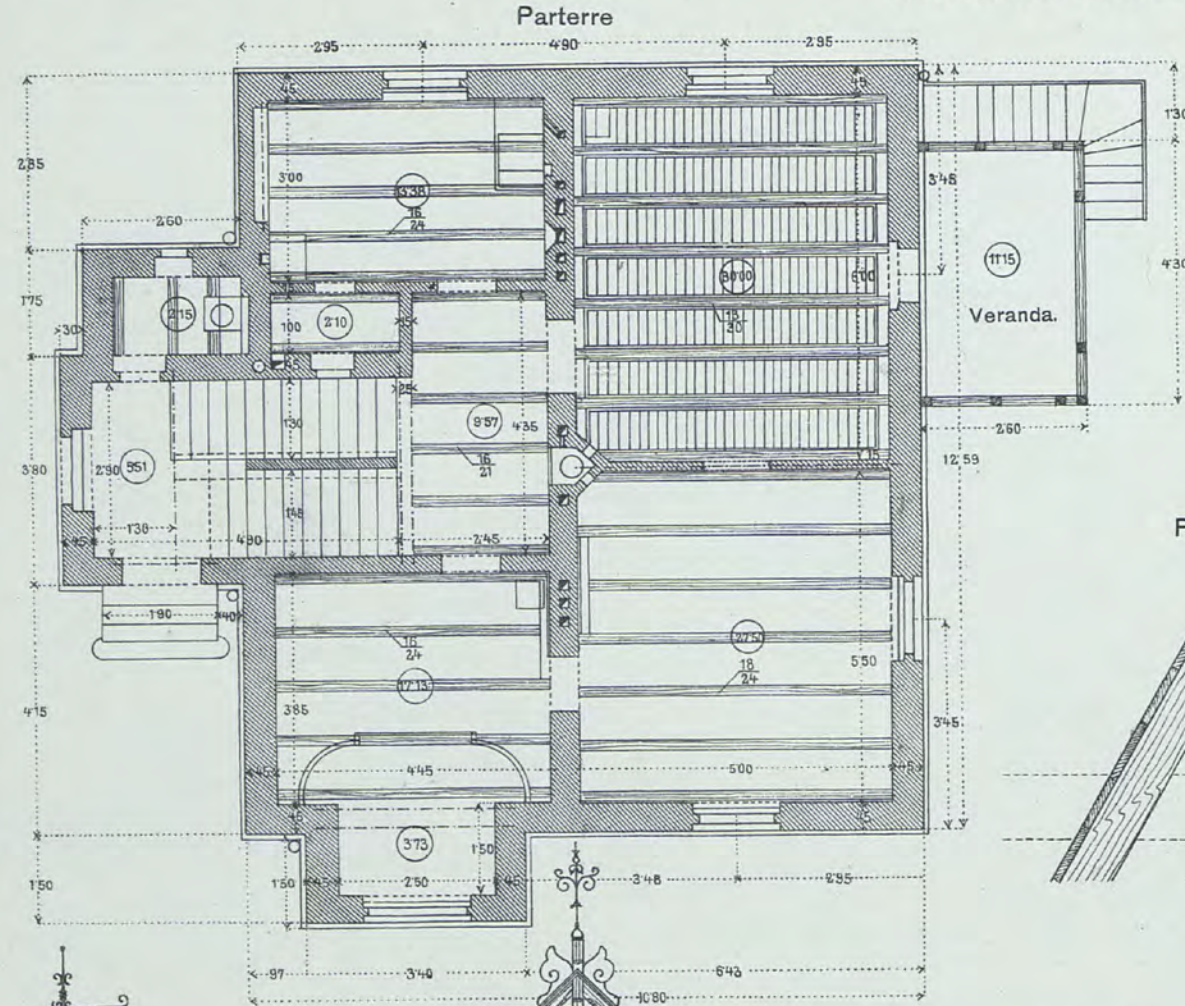

Firstdetail

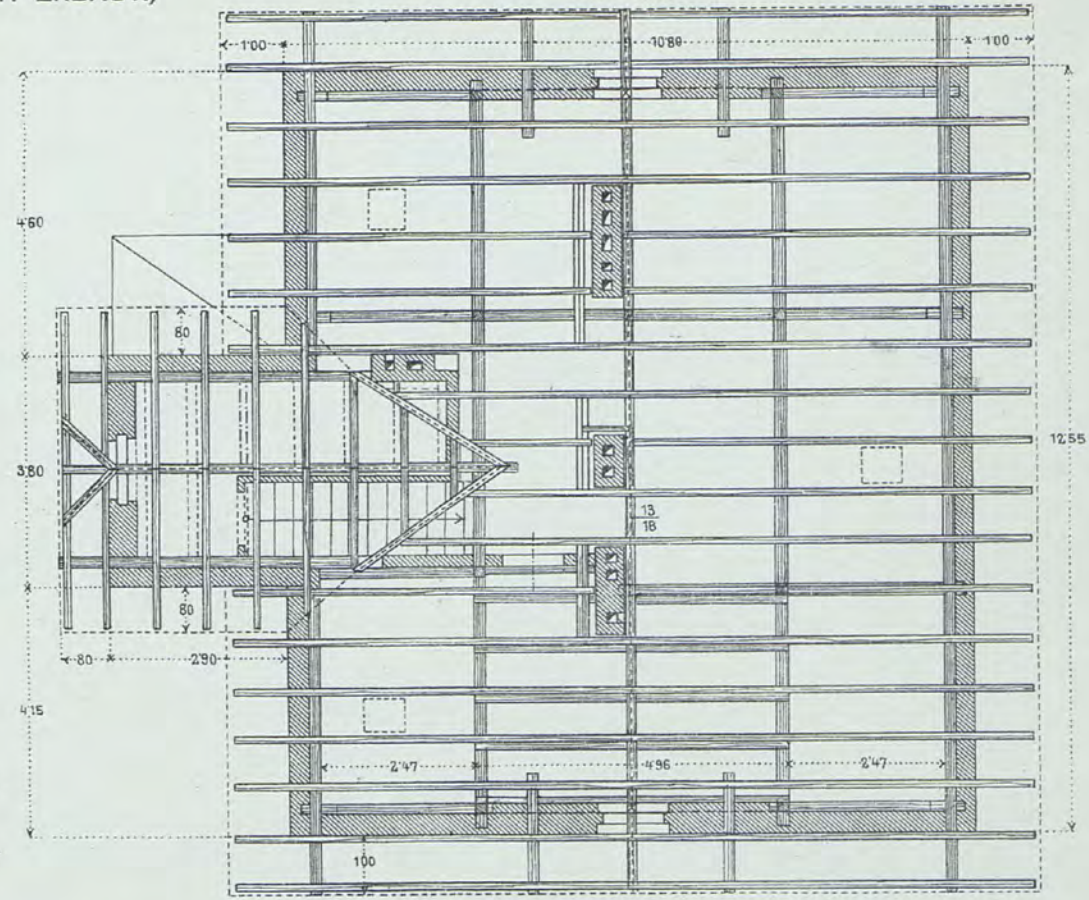
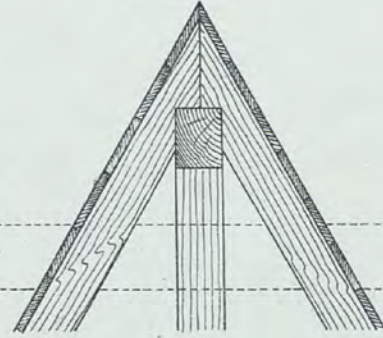

Vorderansicht

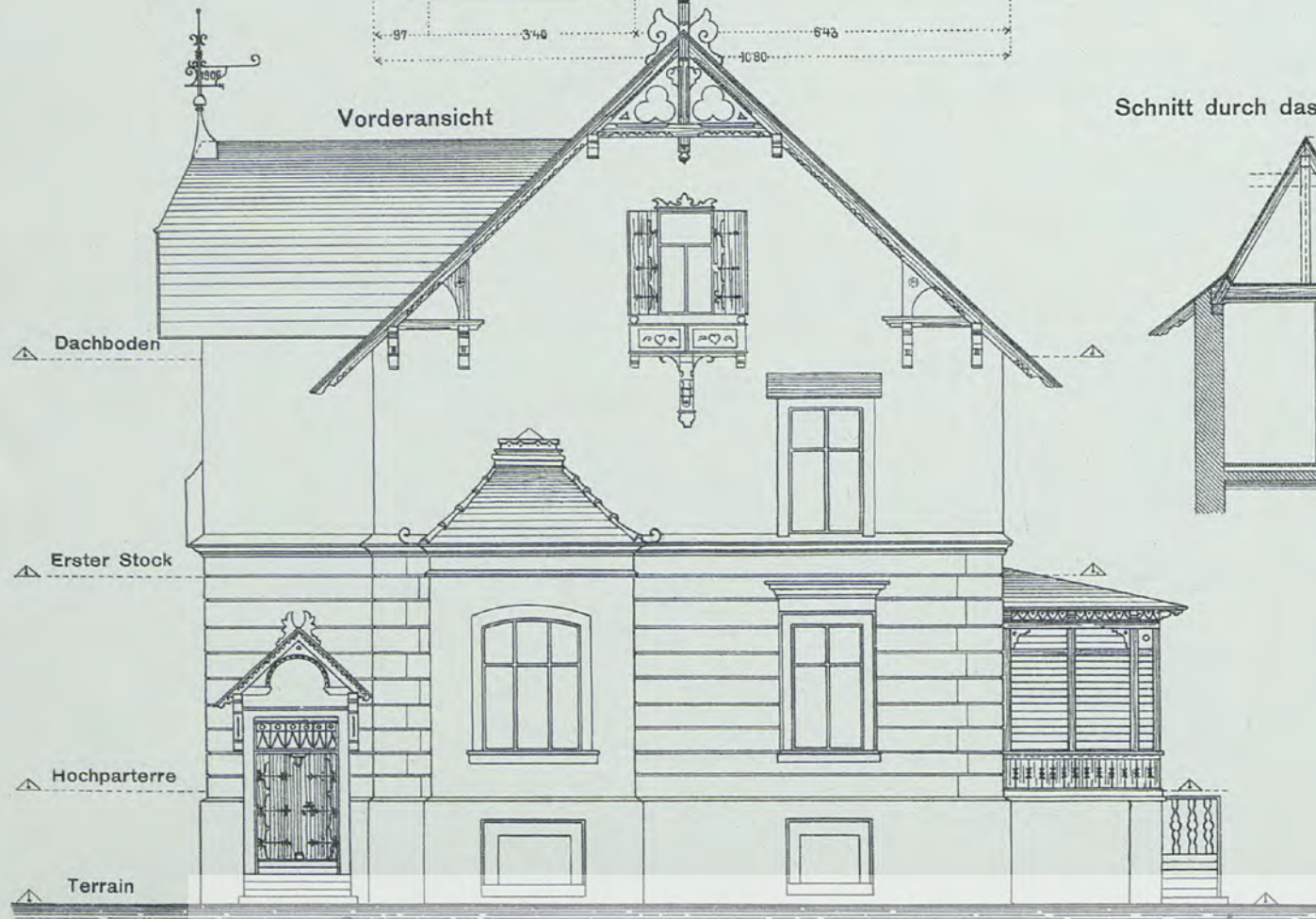

Schnitt durch das Stiegenhaus

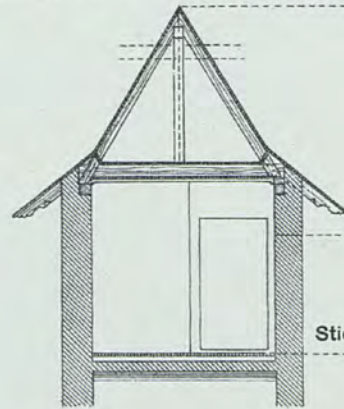

Querschnitt

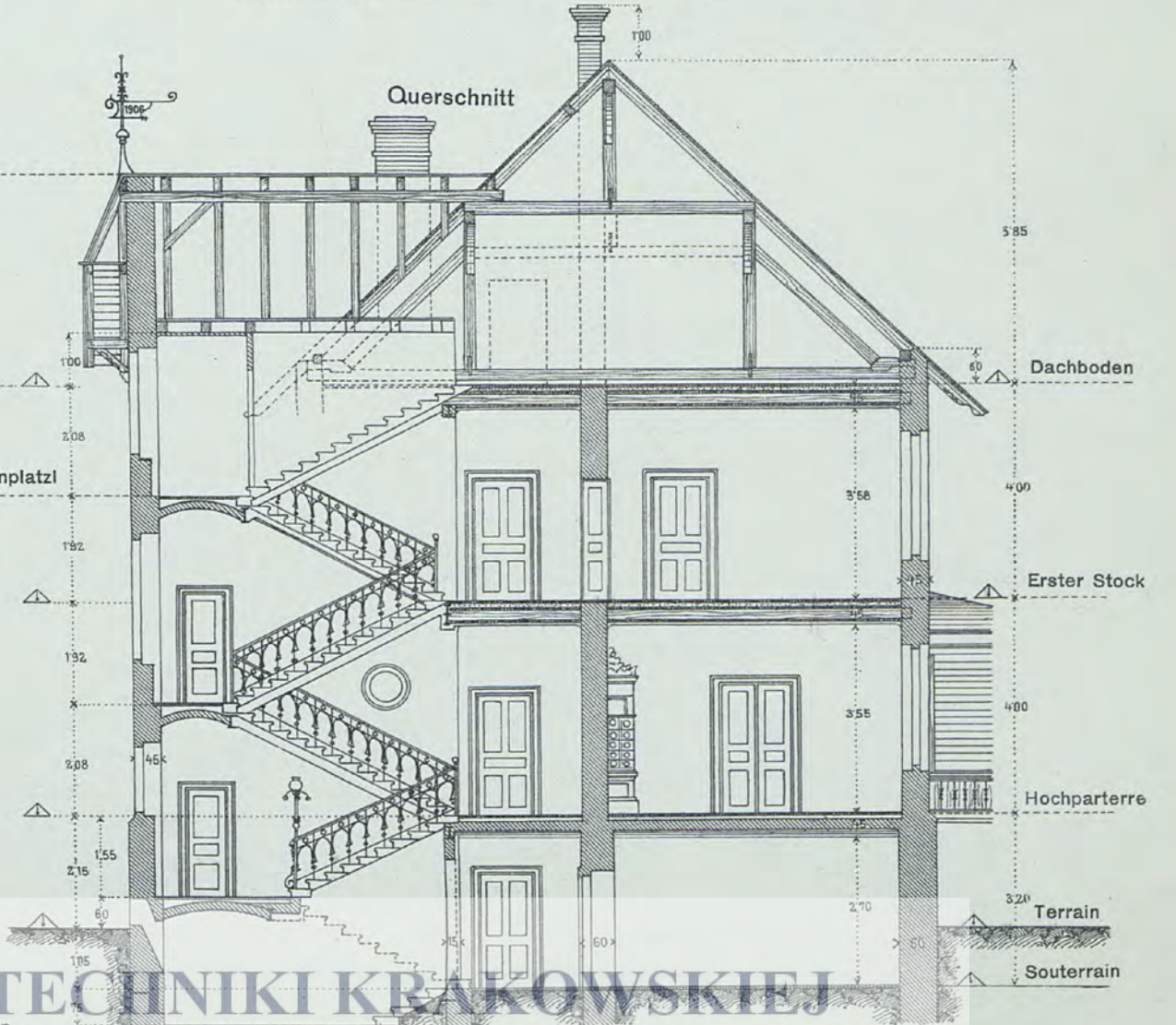

Grundriß 1 für eine Spitalbaracke



2. Zerlegbares Wohnhaus mit Asbestverkleidung für Südafrika

Grundriß 2

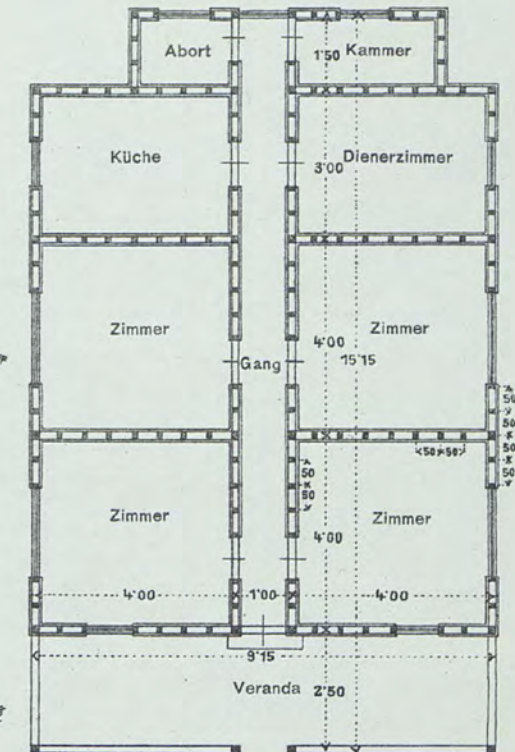

Profil 1

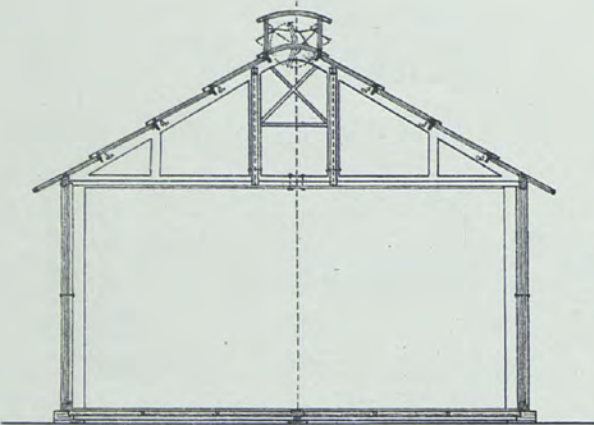

Grundriß für ein Wohnhaus. 1a

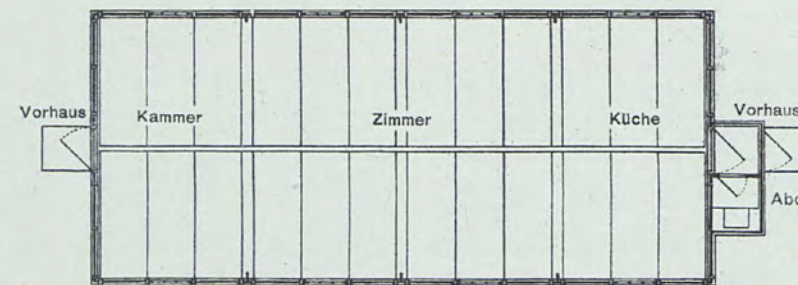

Profil 2

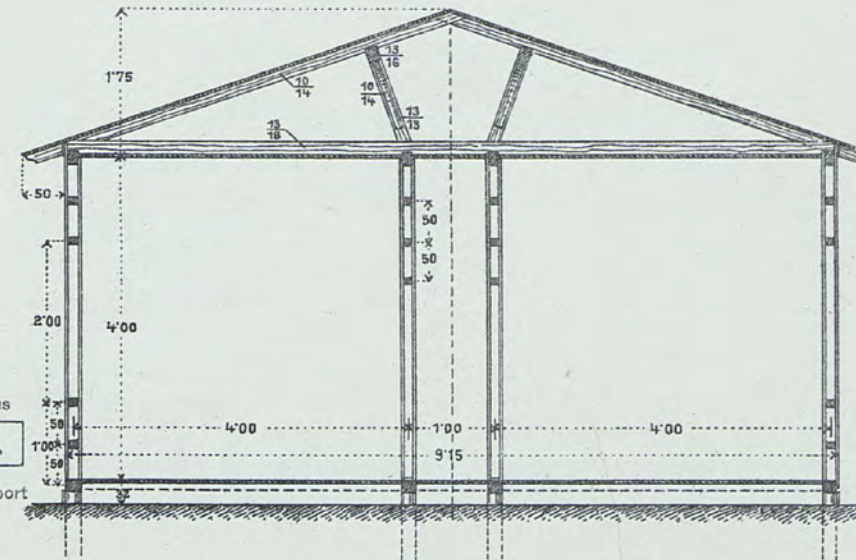

Giebelansicht 2

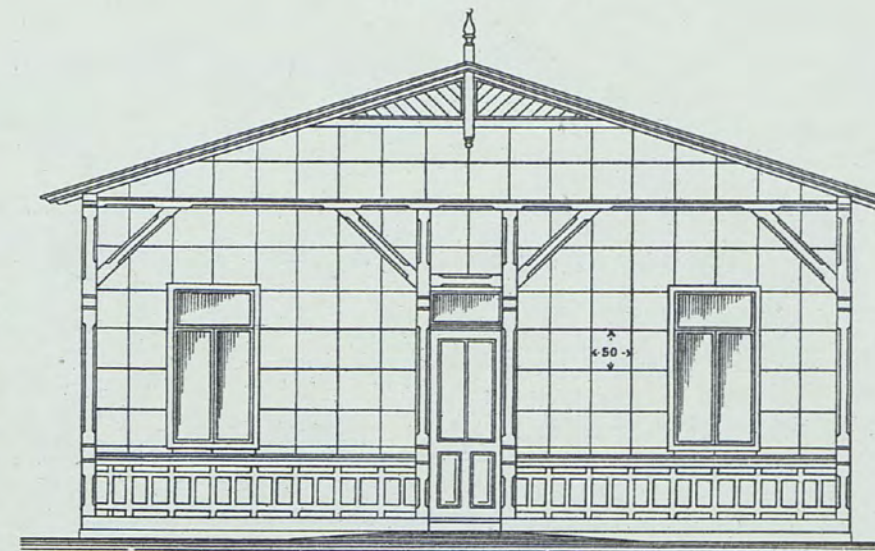

Seitenansicht 2

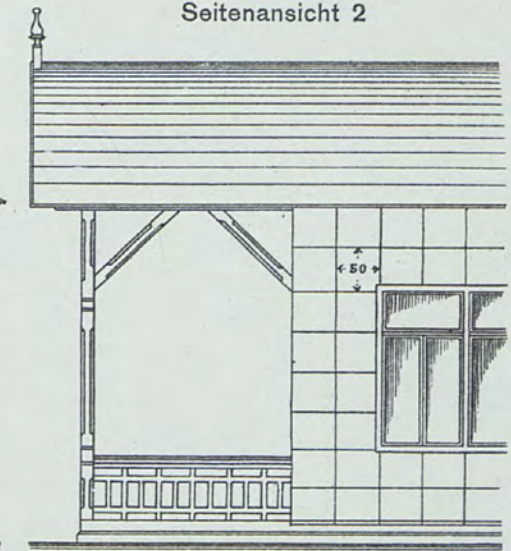

Giebelansicht 1

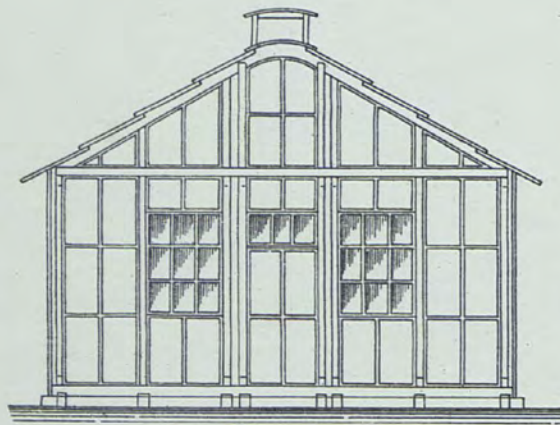

Seitenansicht 1

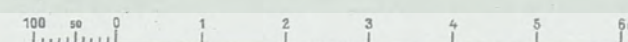
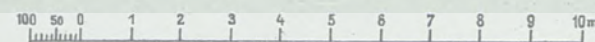
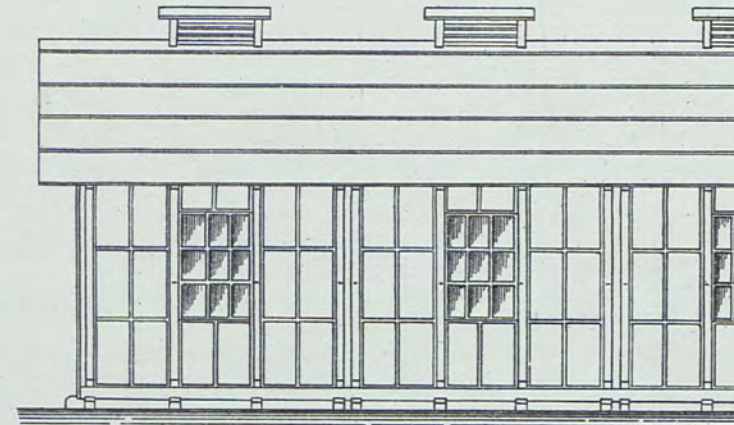

Profil 1

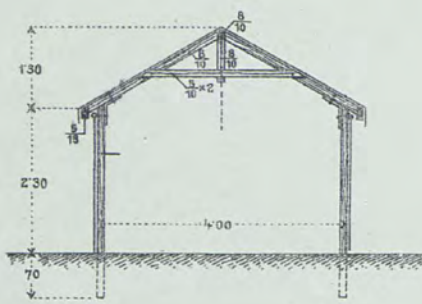

Längenschnitt 1

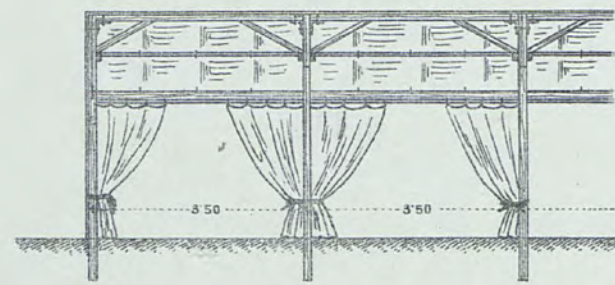

Profil 3

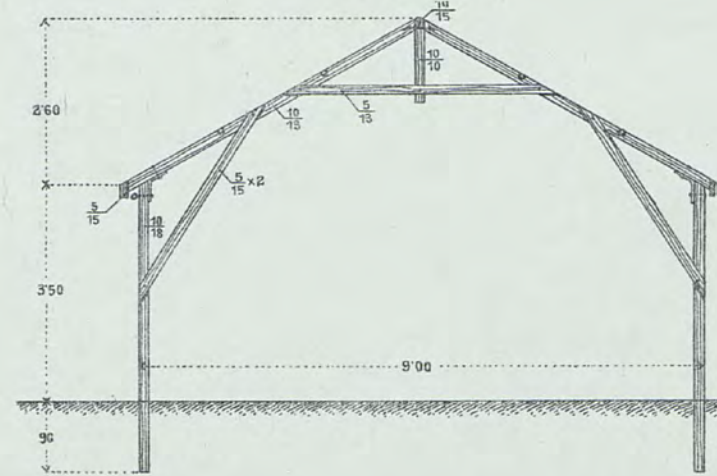

Längenschnitt 3

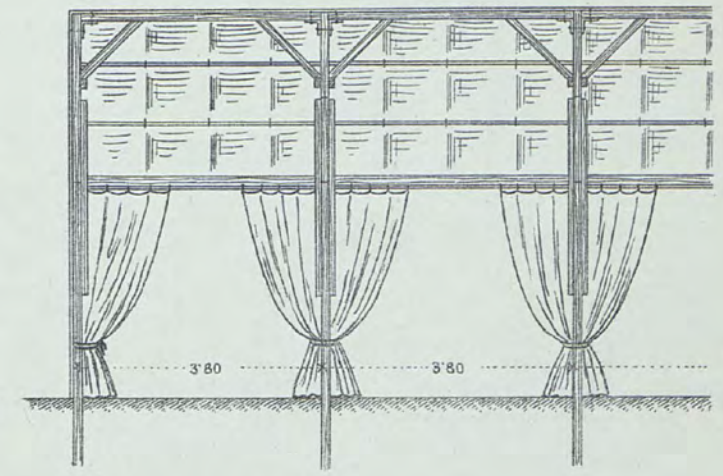

Werksatz 1

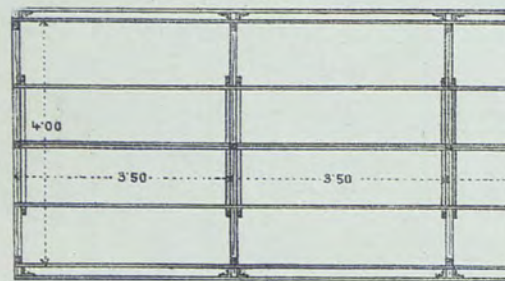

Ansicht 1

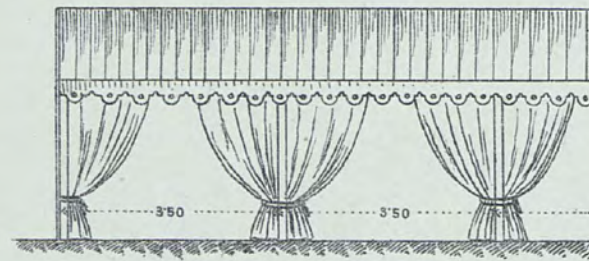

Saumdetail

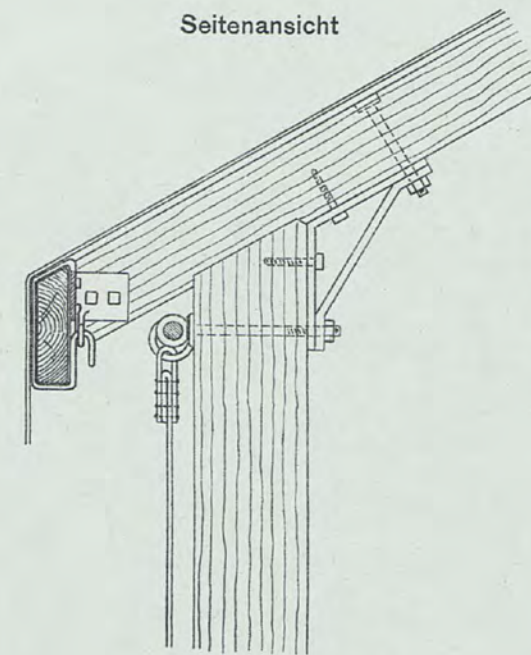

Vorderansicht

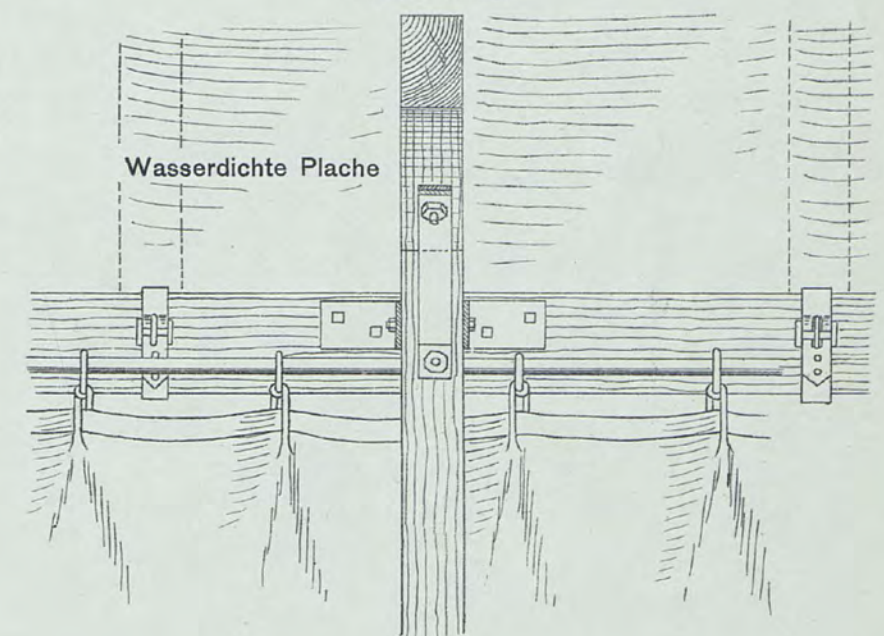

Profil 2

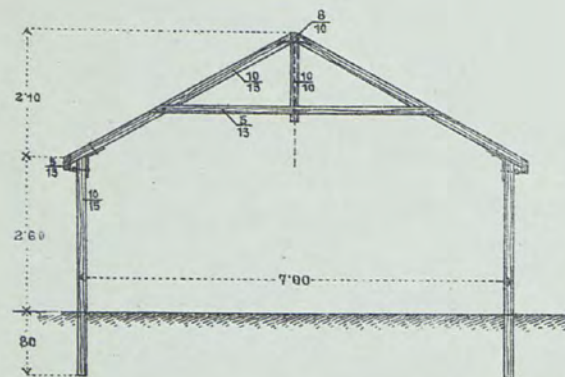

Längenschnitt 2

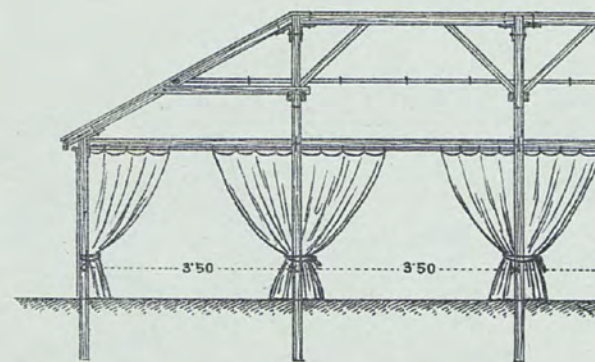

Seitenansicht

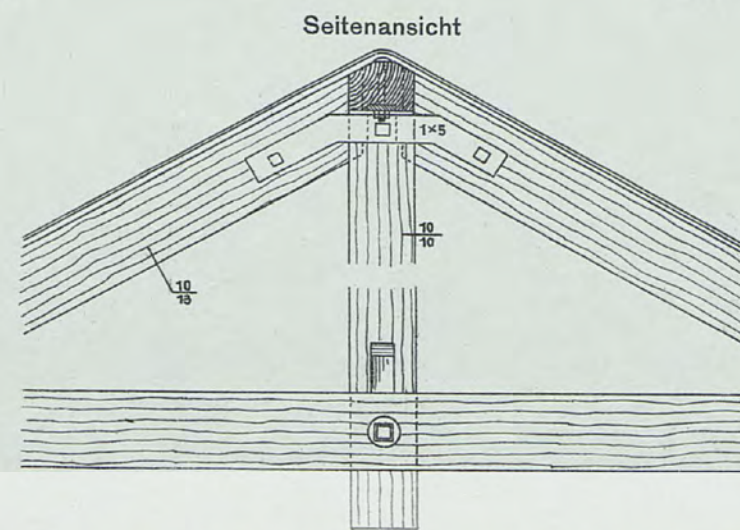

Firstdetail

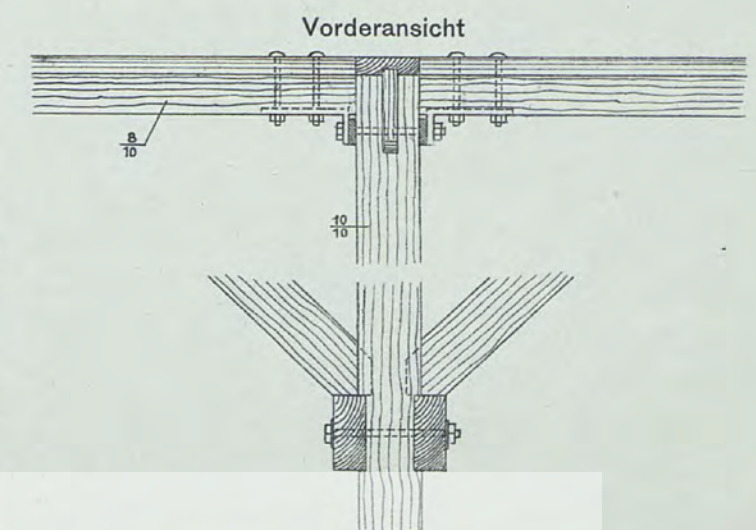

Werksatz 2

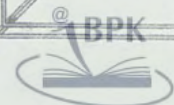
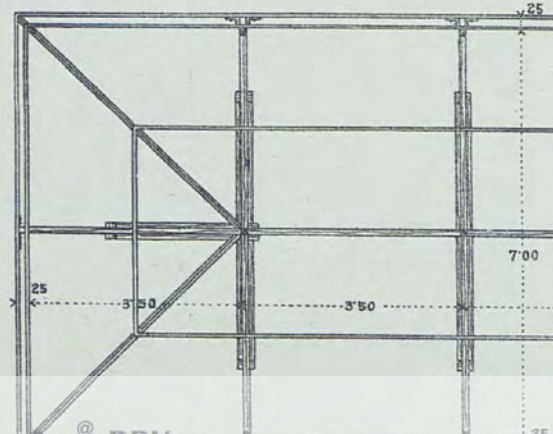

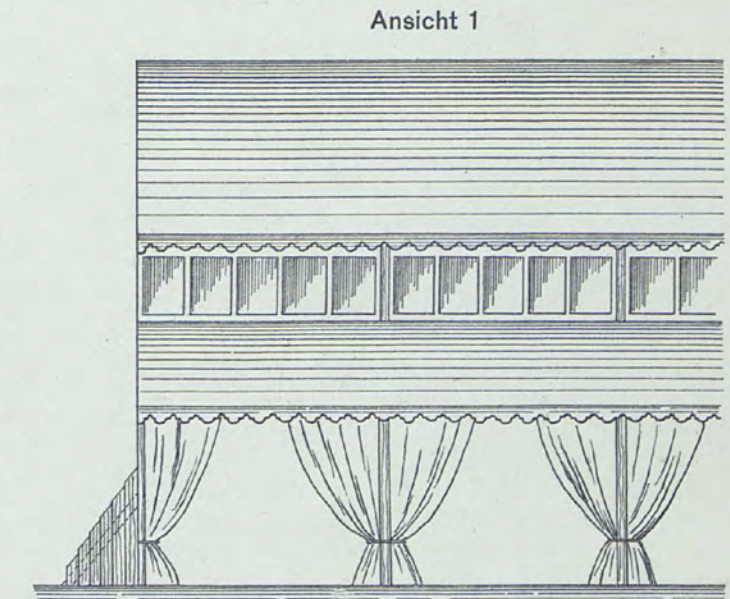
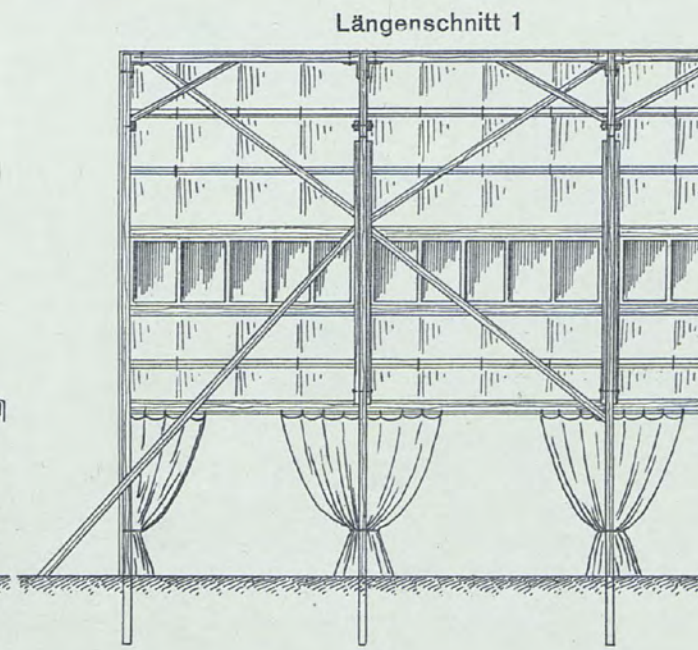
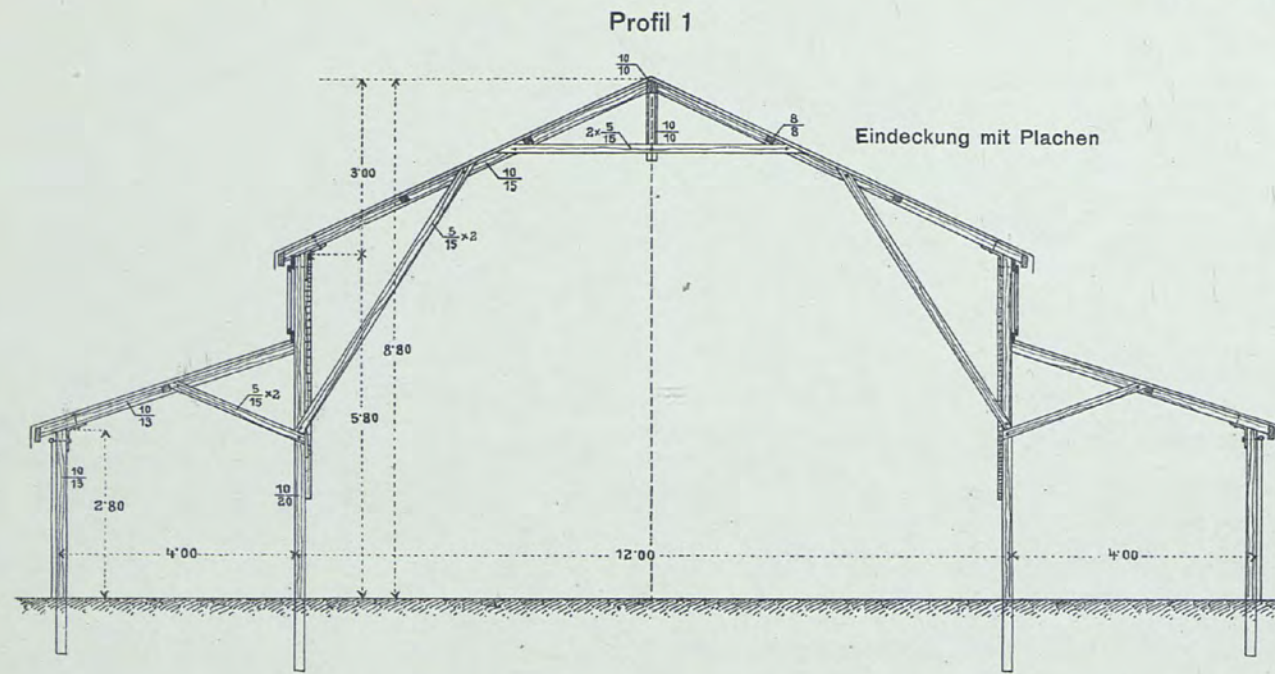

Windverstrebung in Wand und Dach

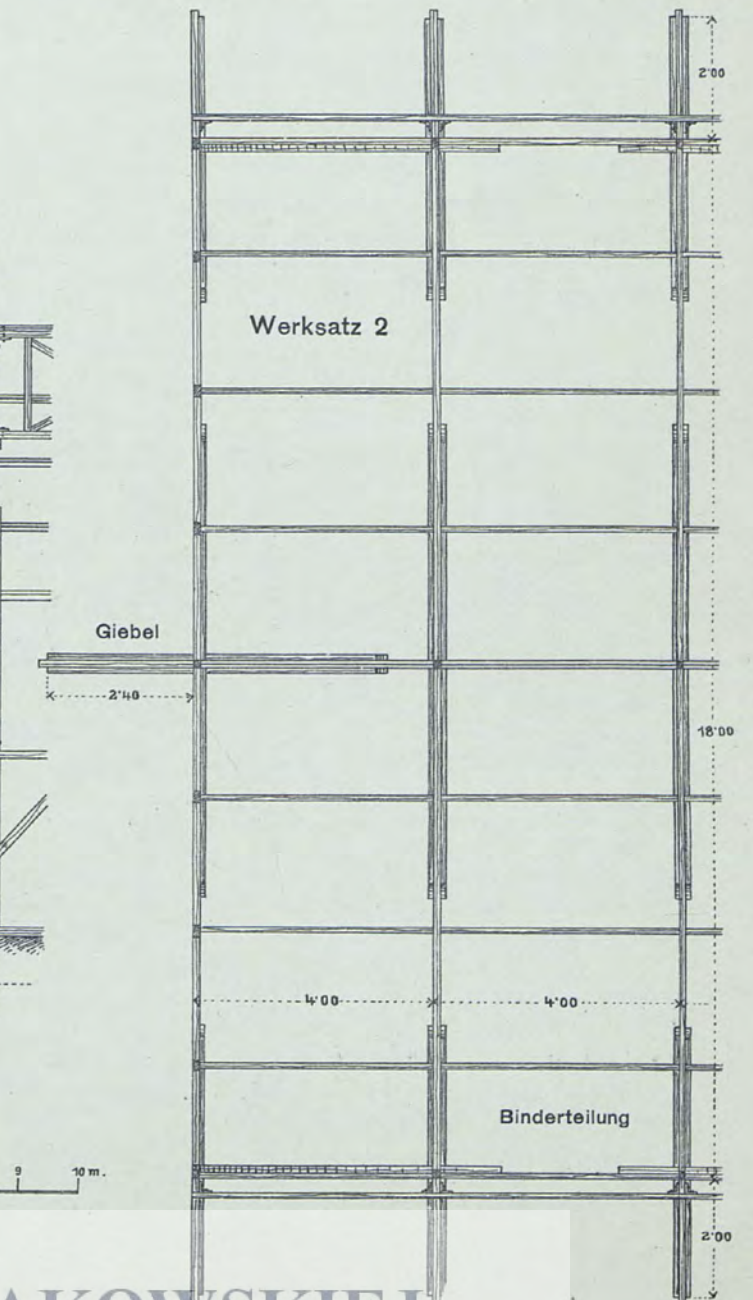
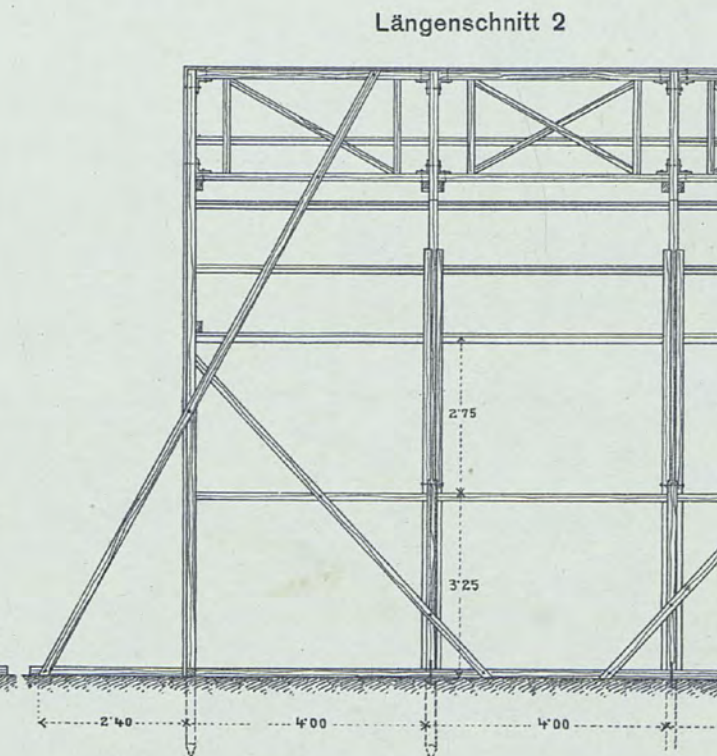
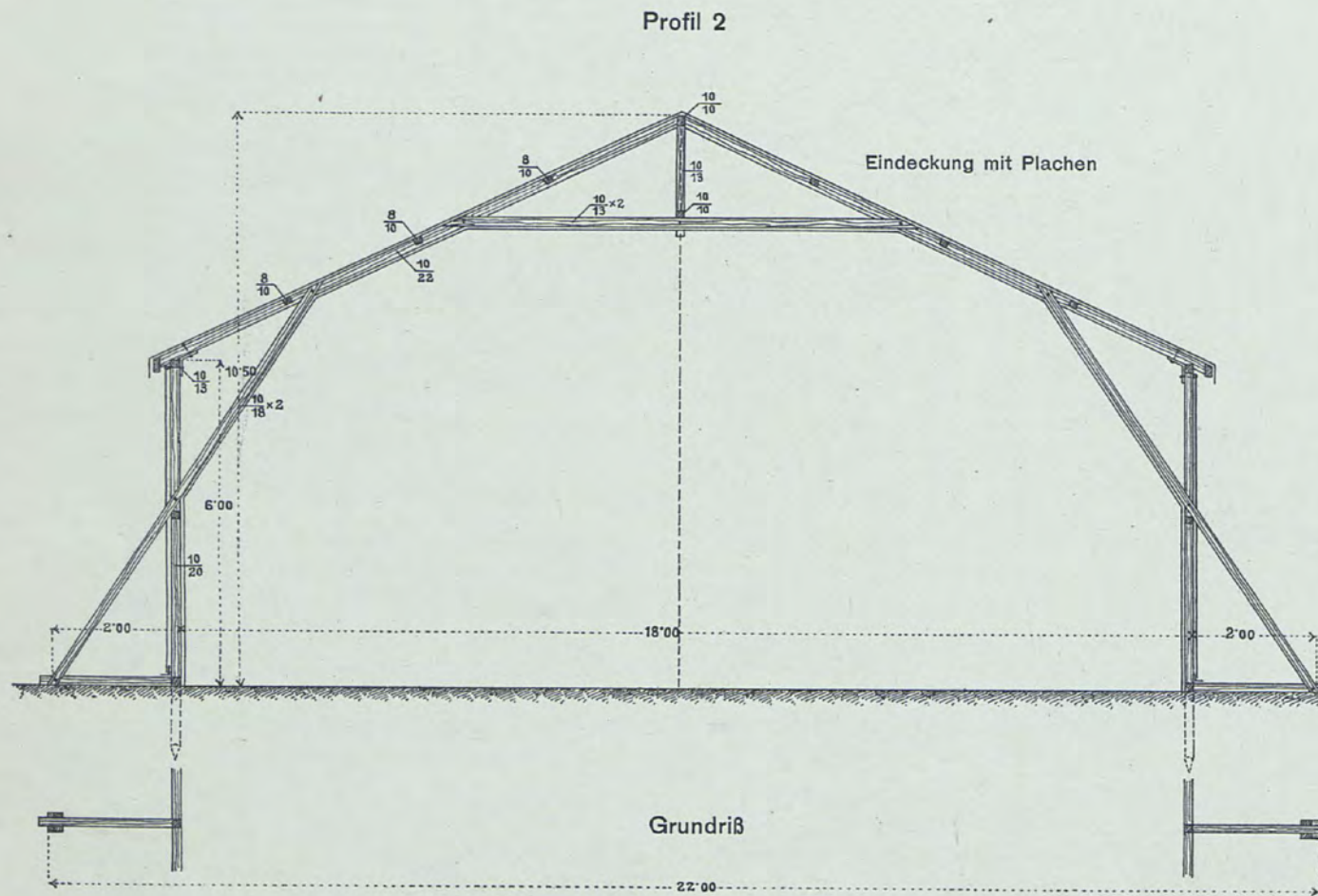

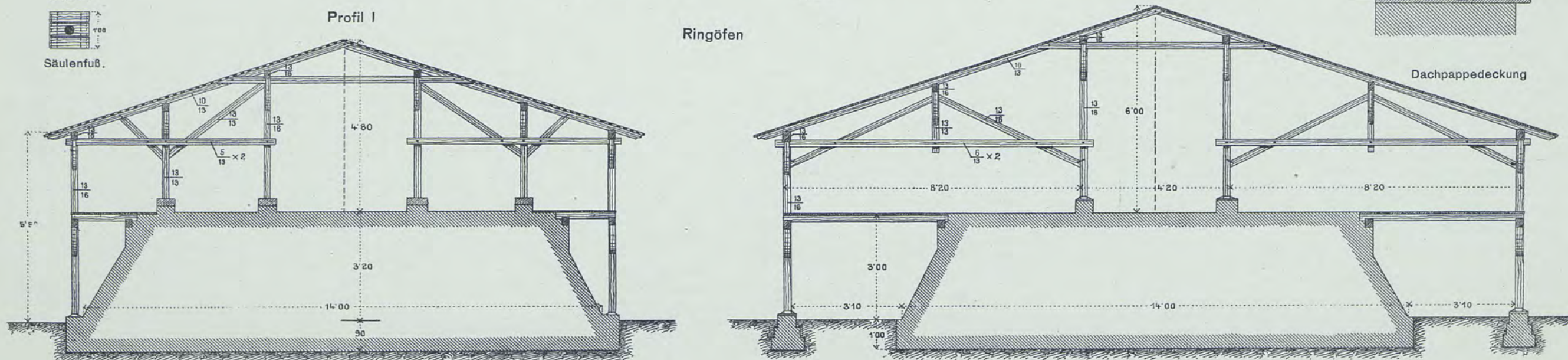
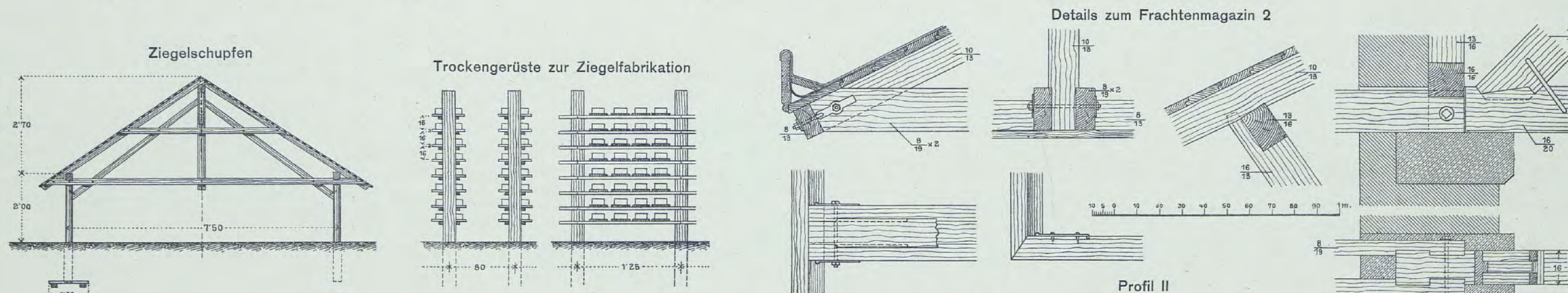
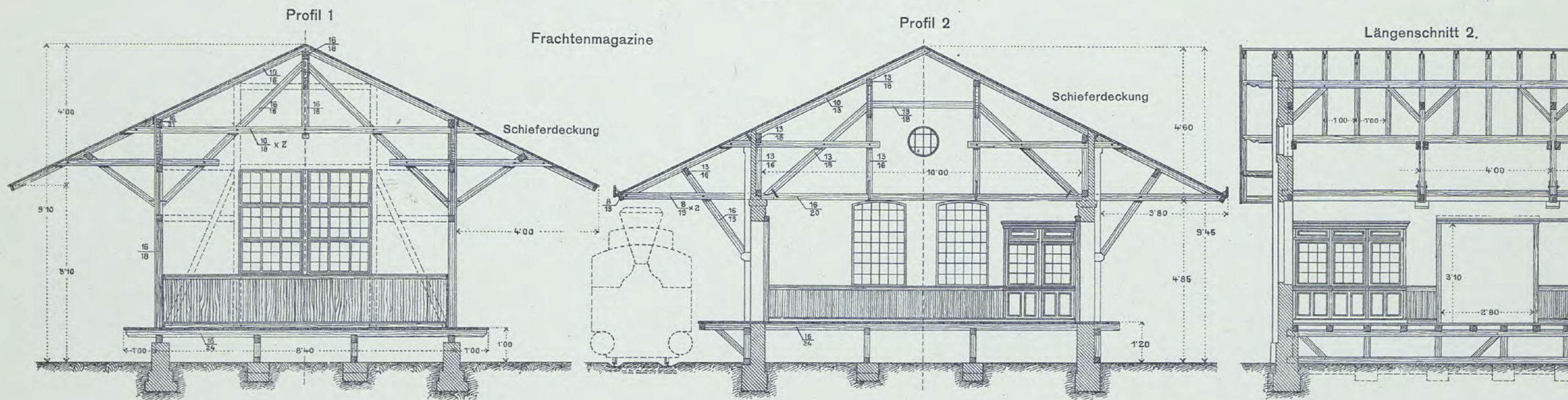

Querschnitt

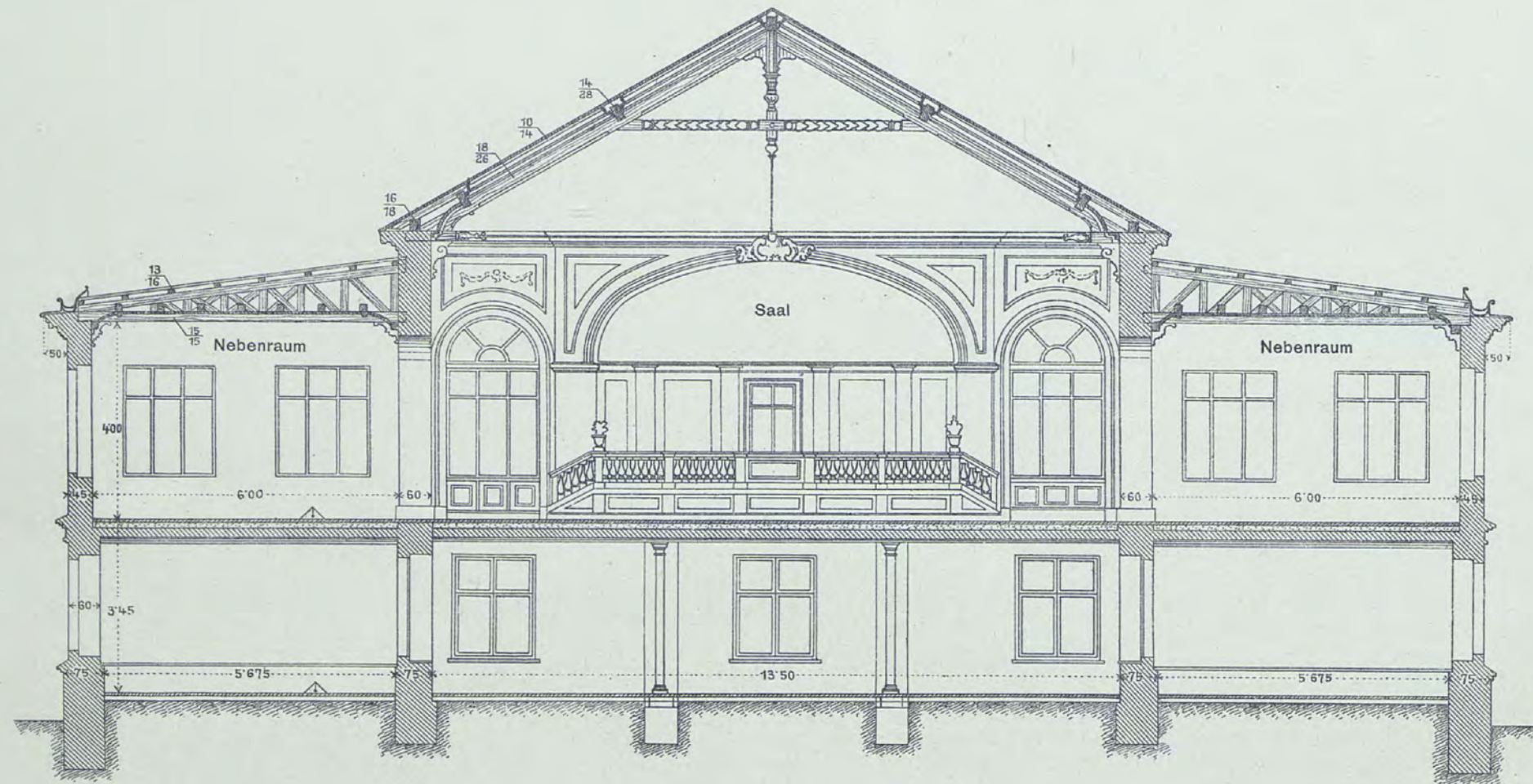

Längenschnitt

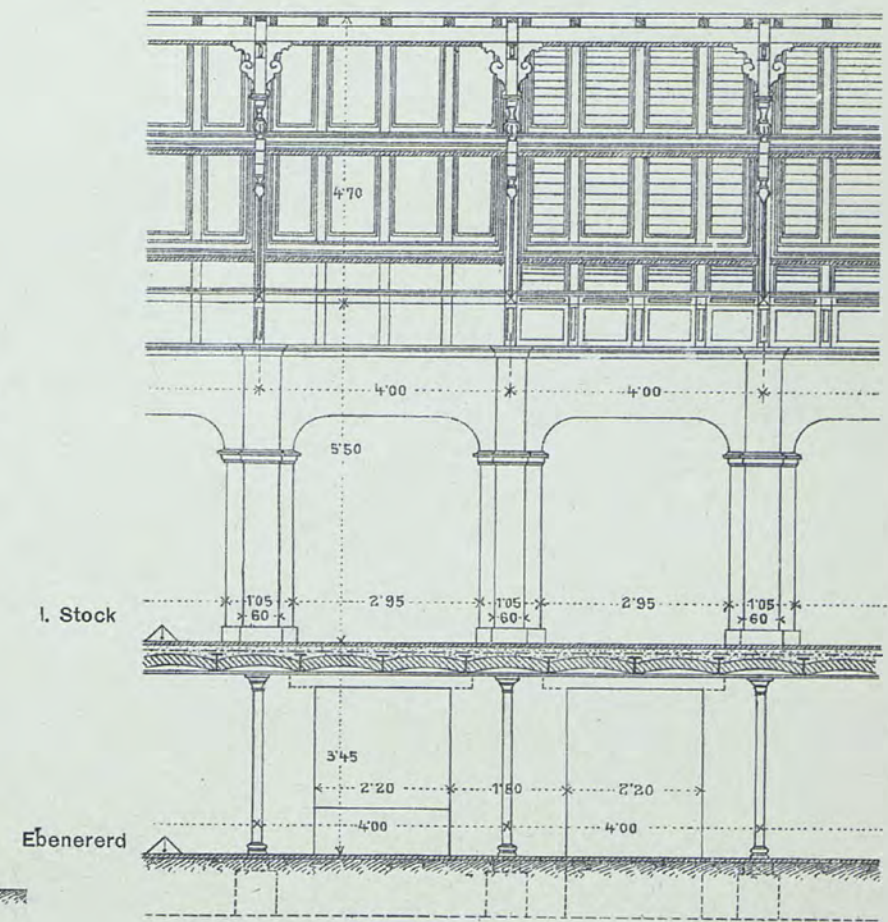

Saumdetail

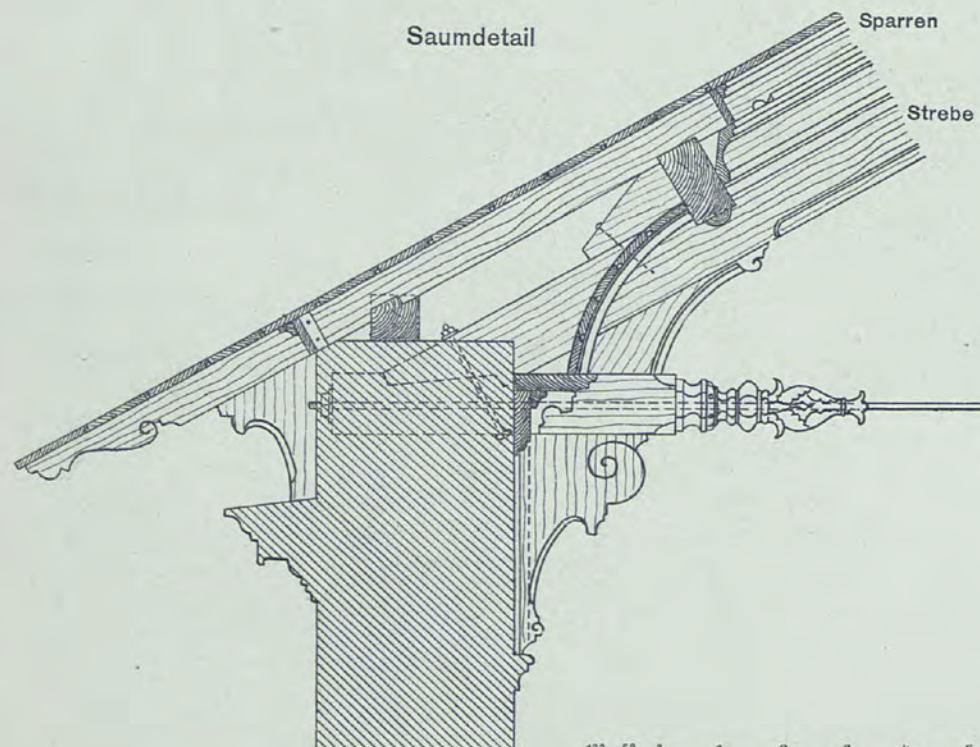

Querschnitt

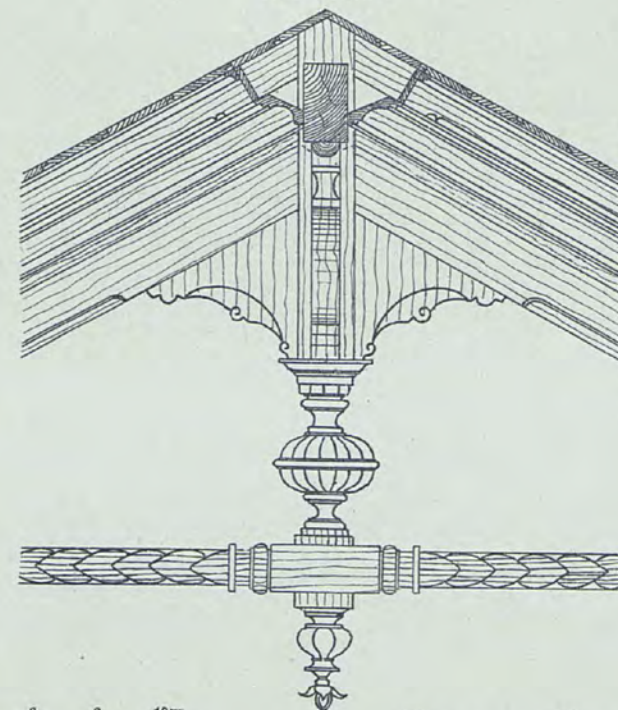

Firstdetail

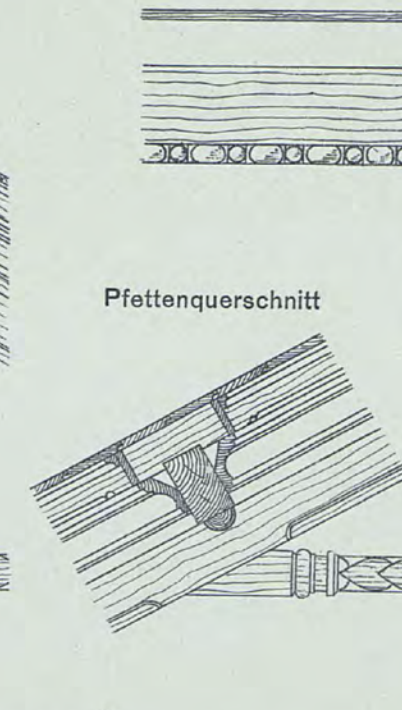

Ansicht

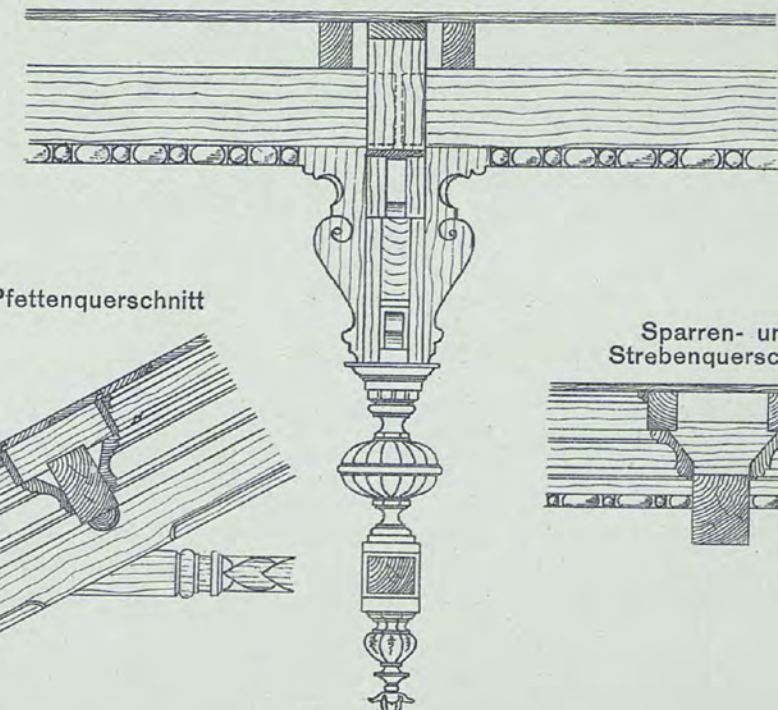

Pfettenquerschnitt

Sparren- und Strebenquerschnitt

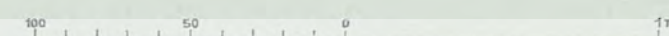
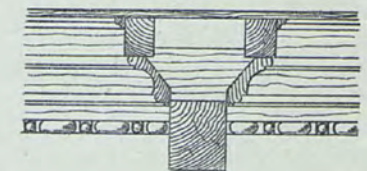

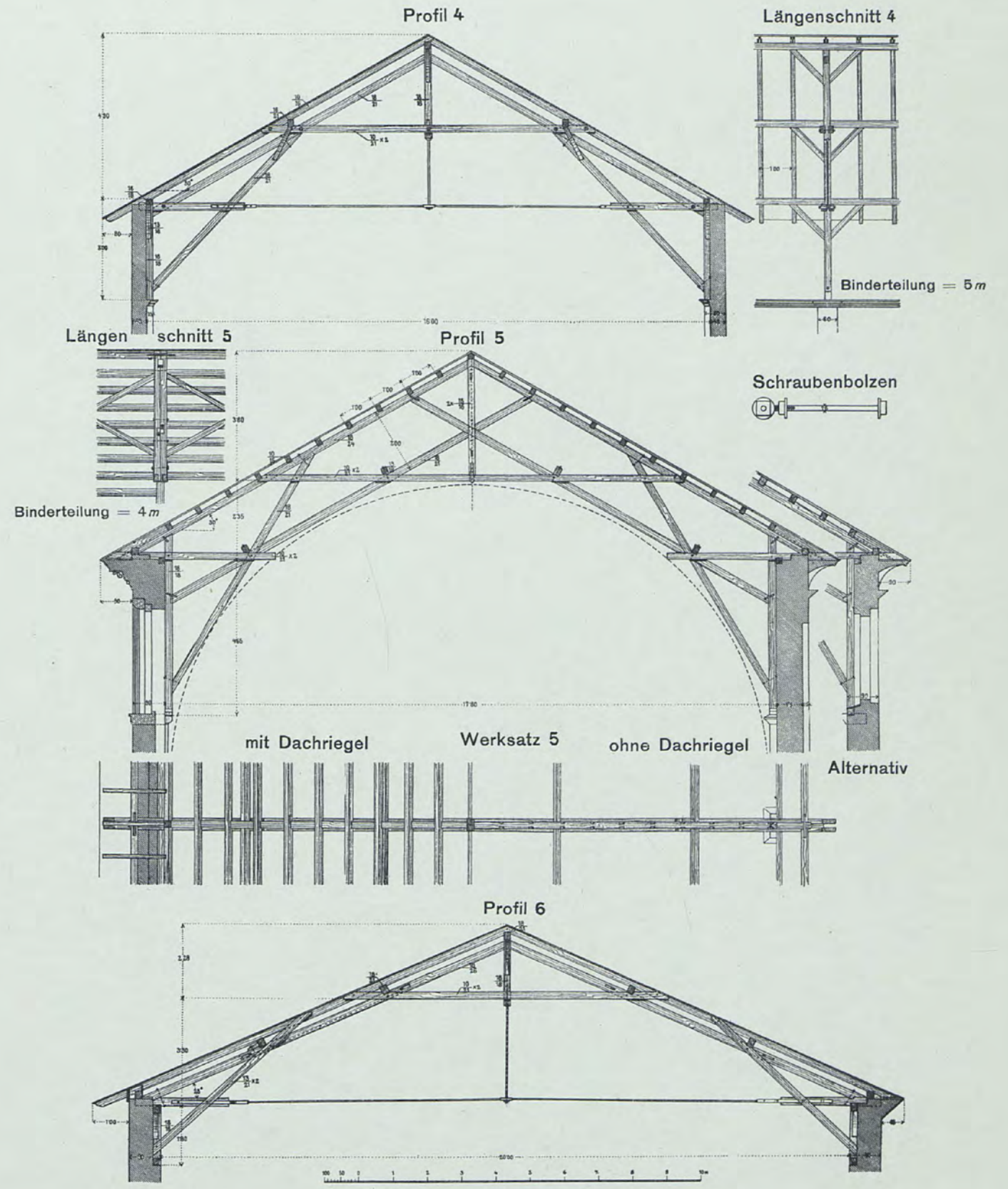
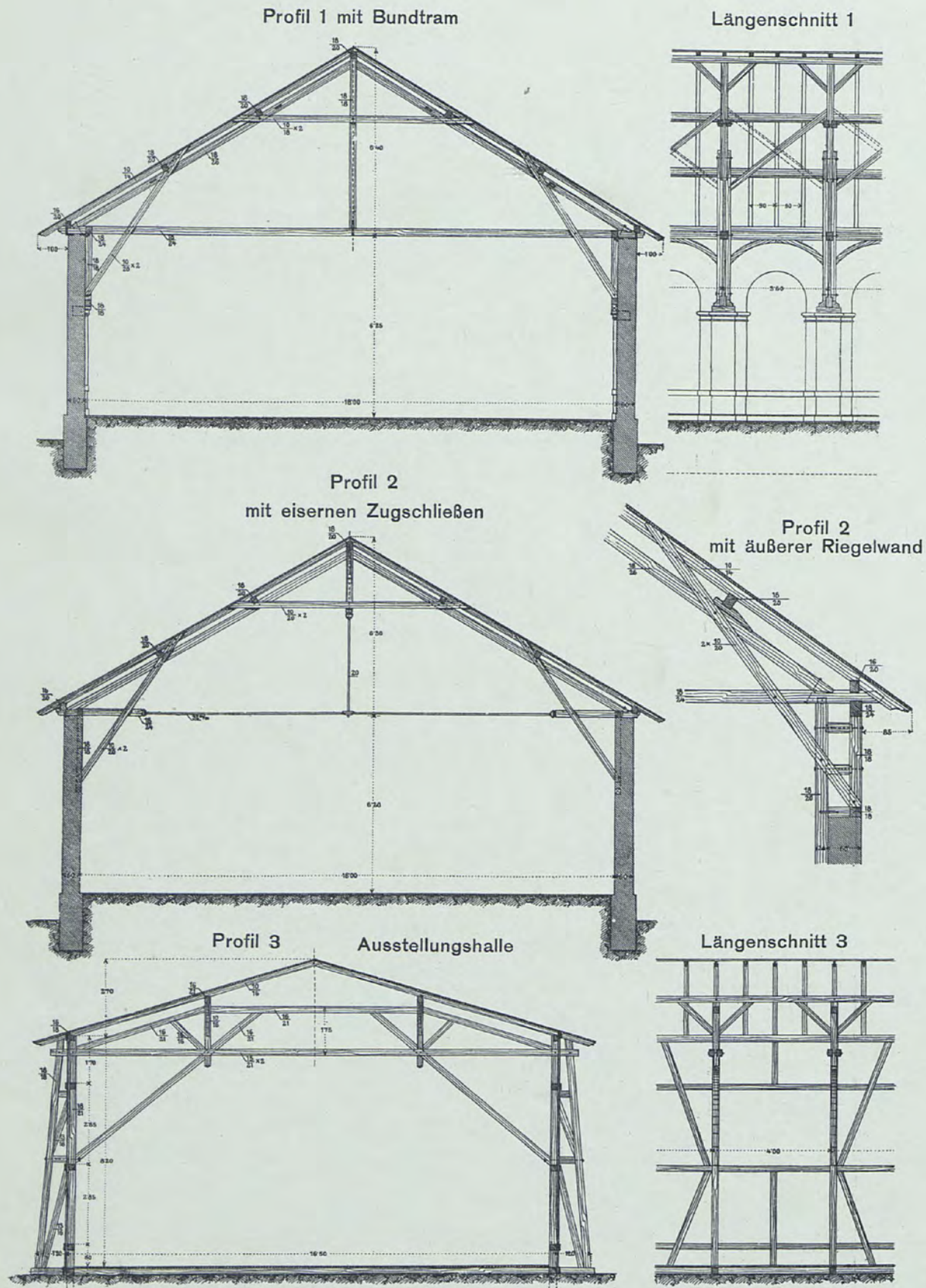

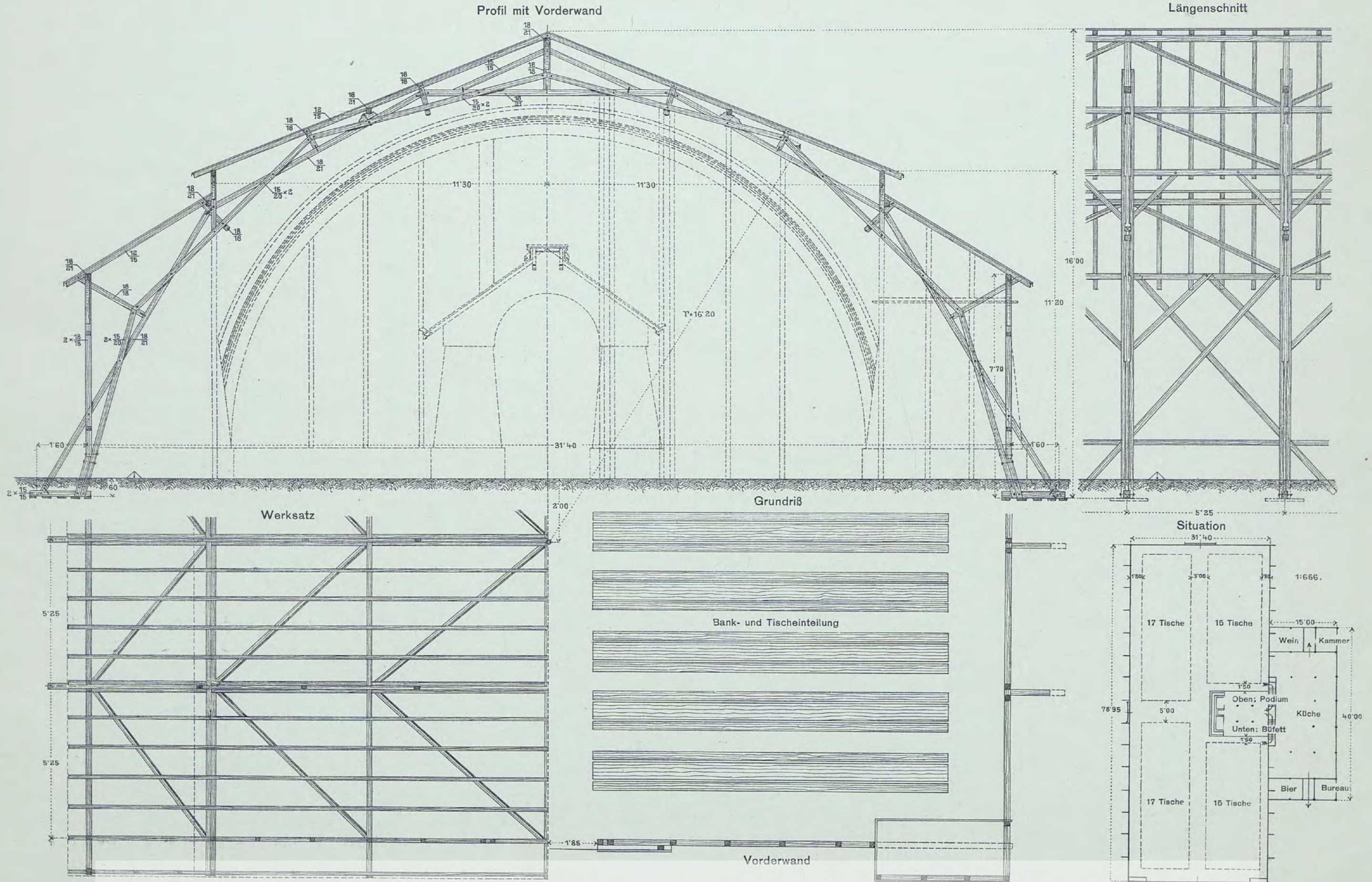

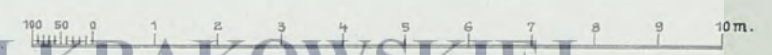
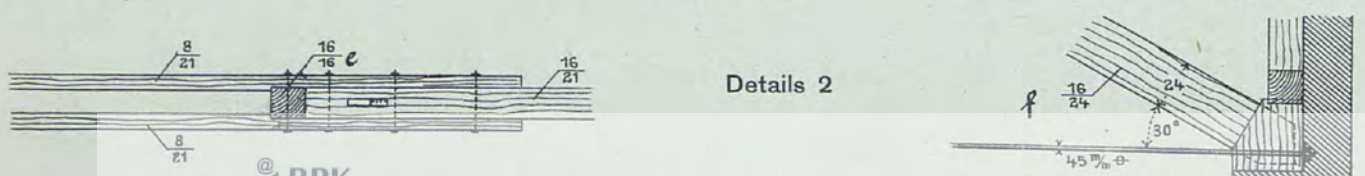
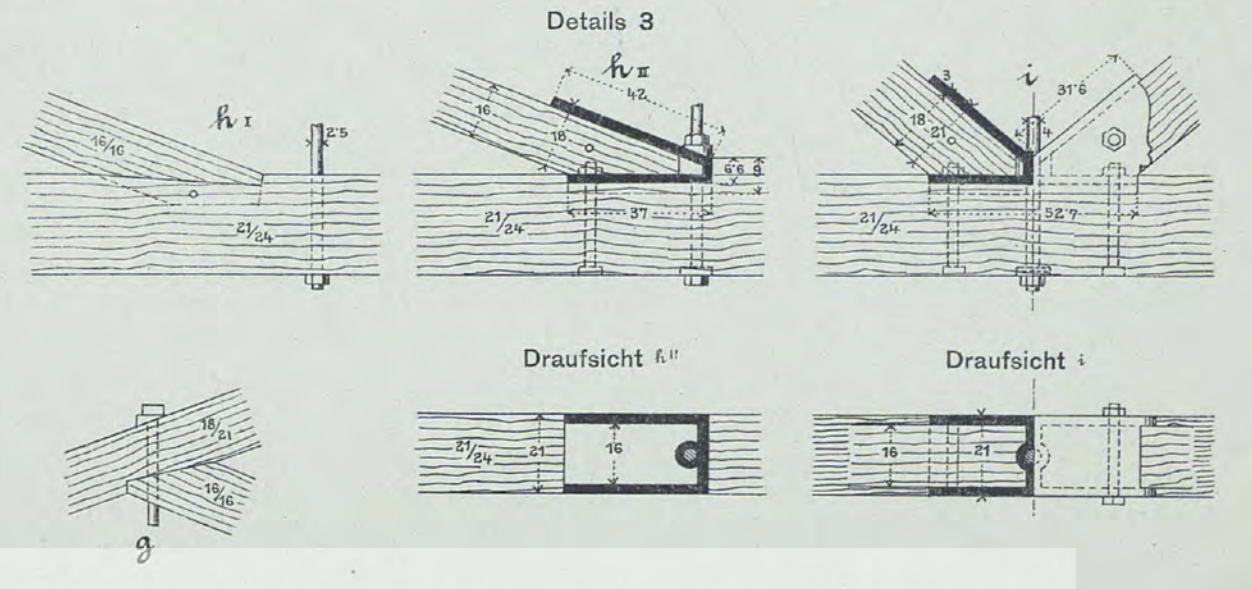
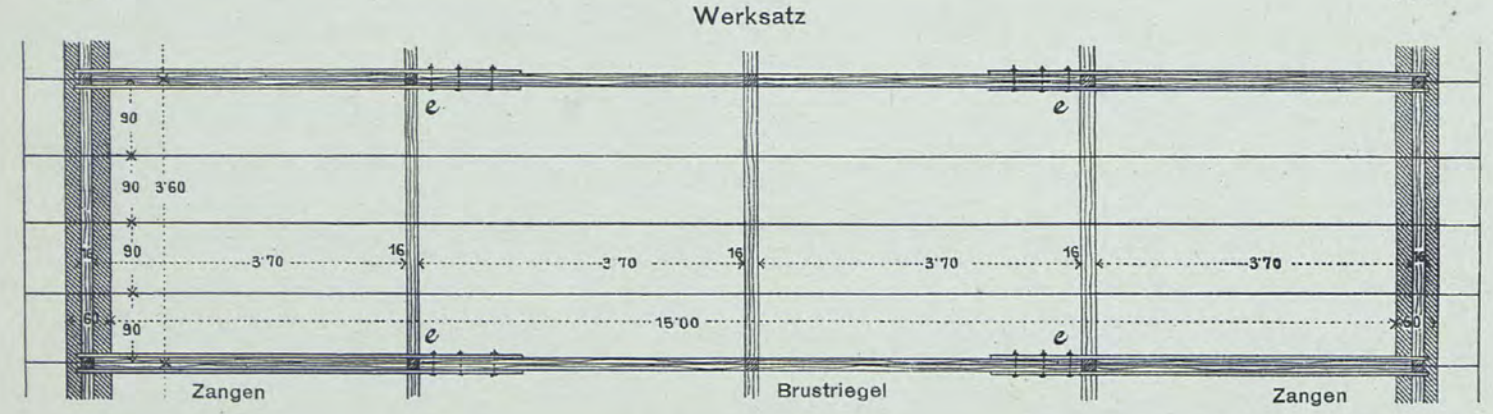
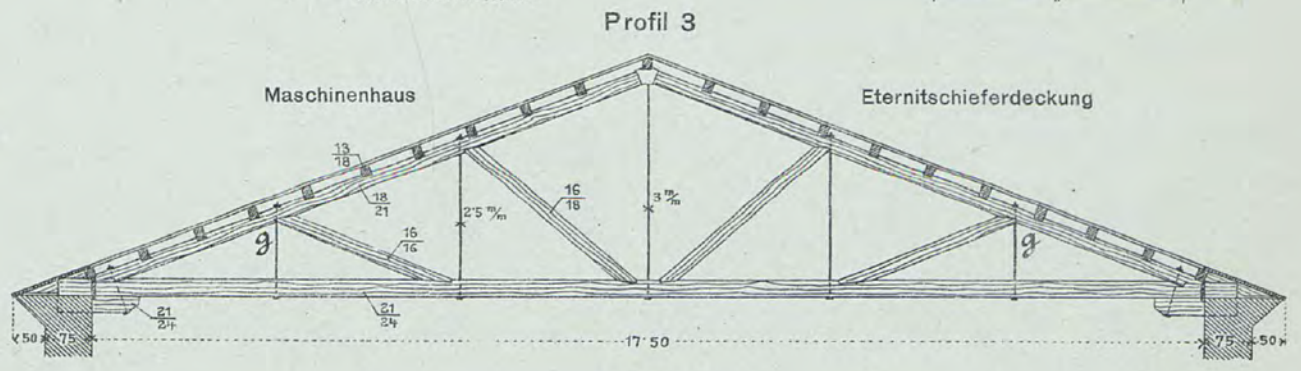
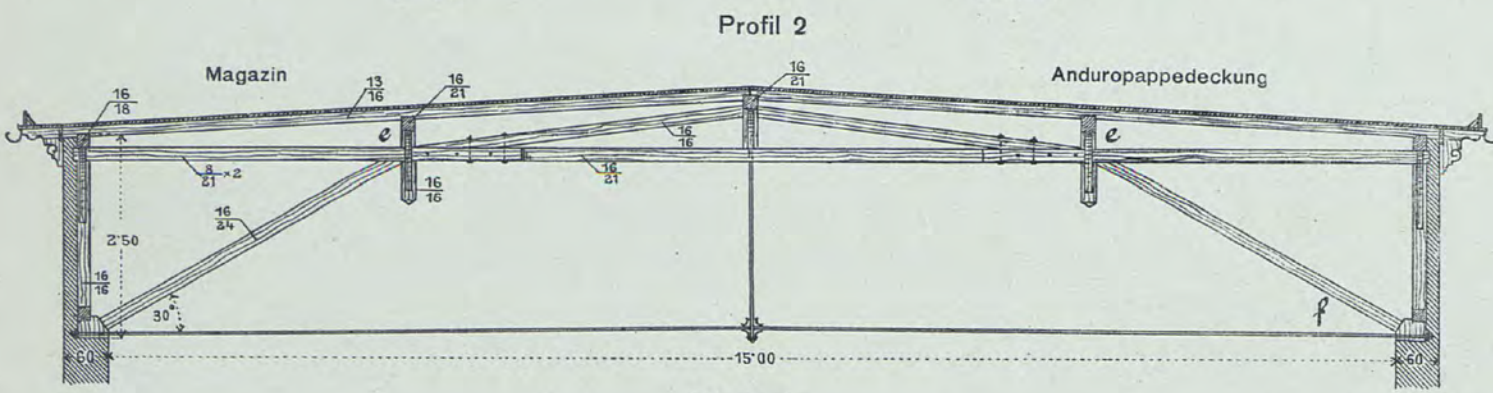
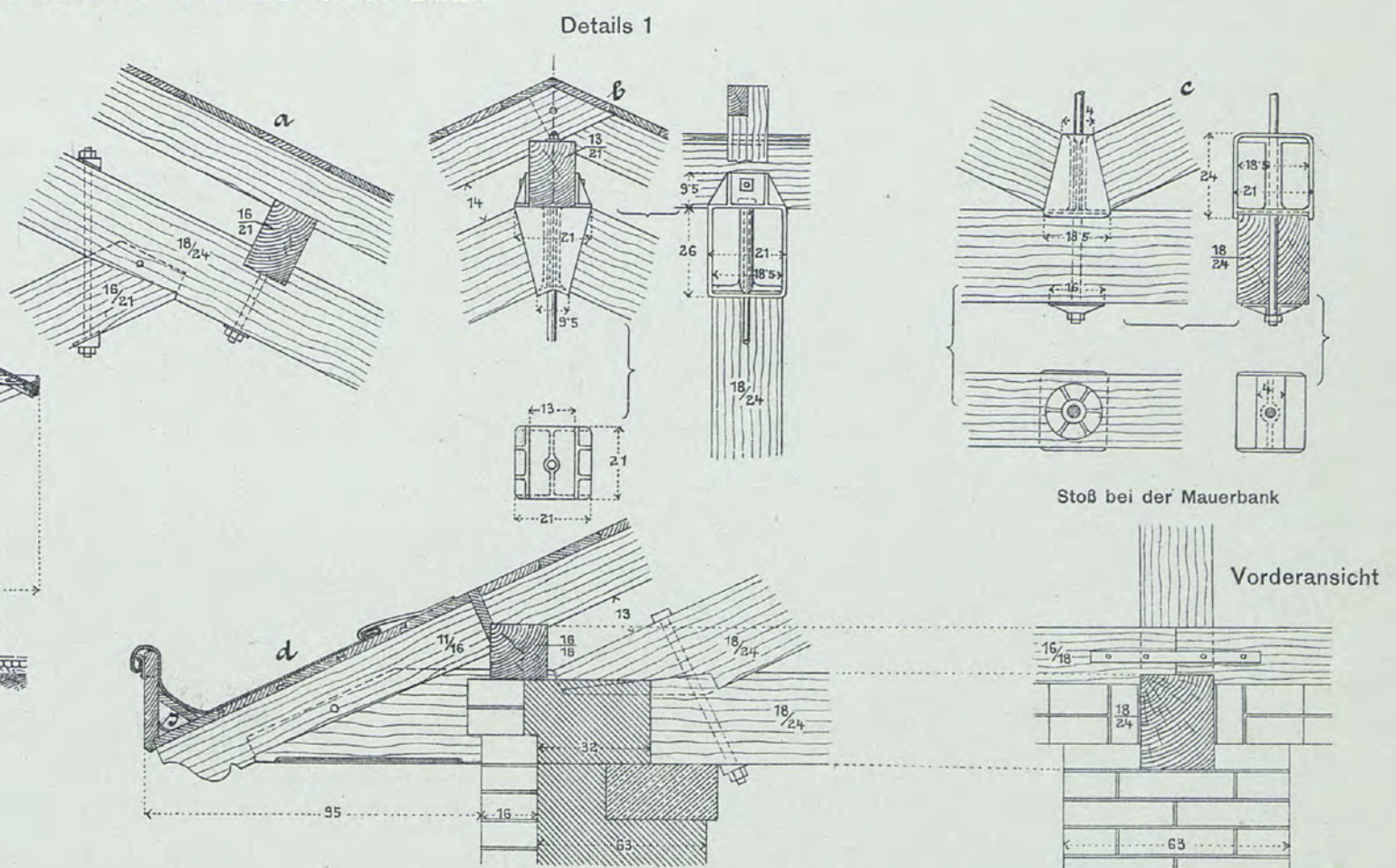
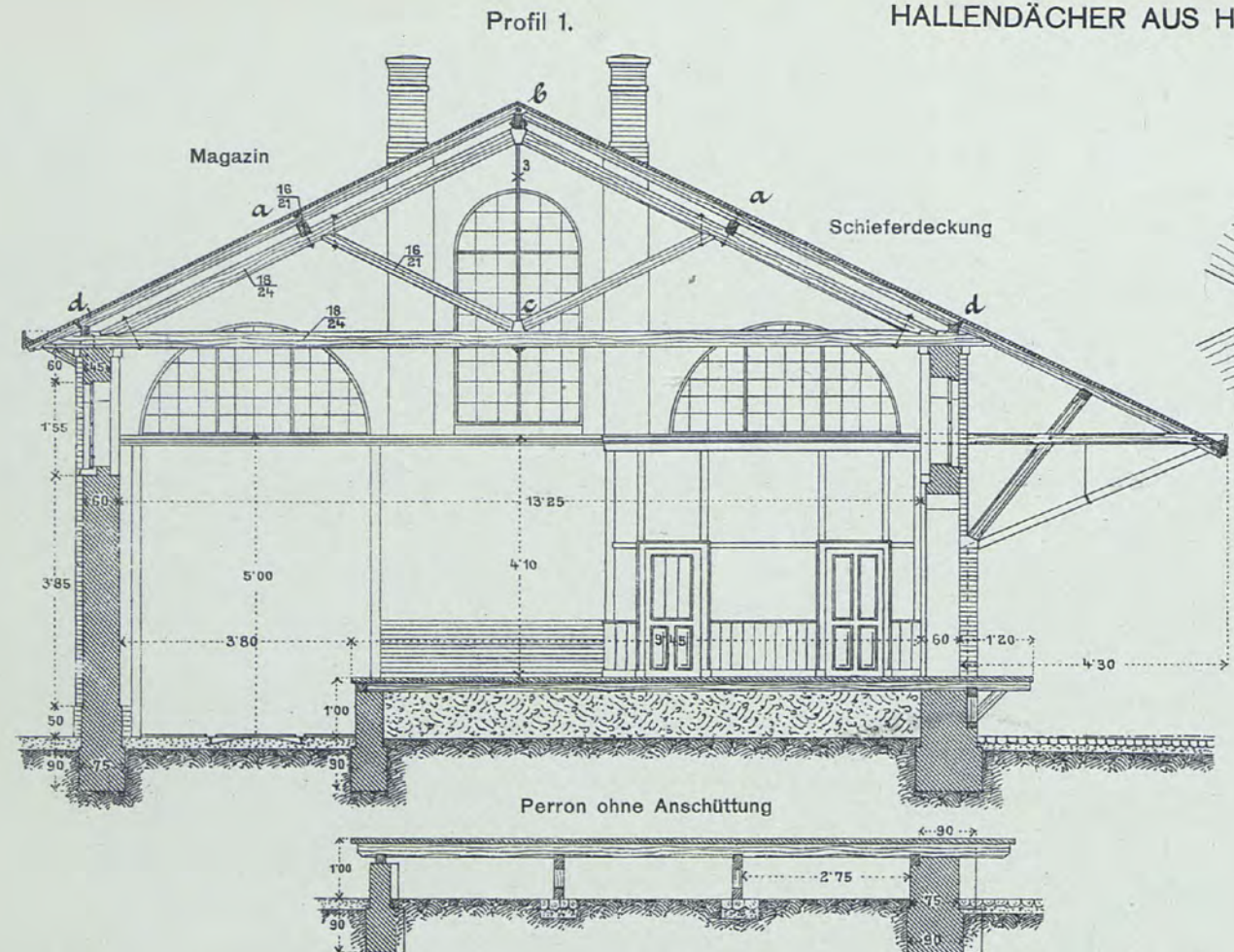

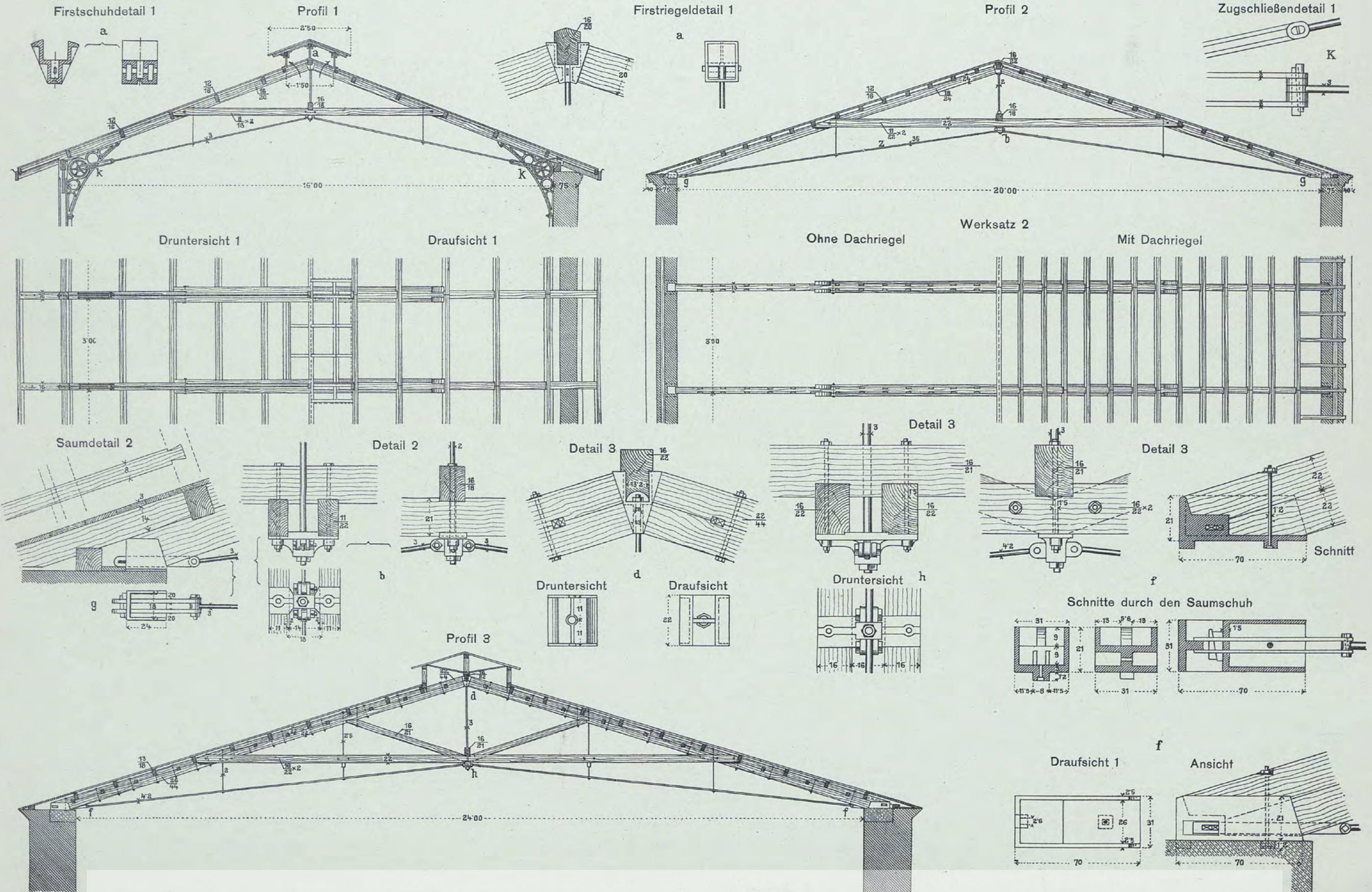

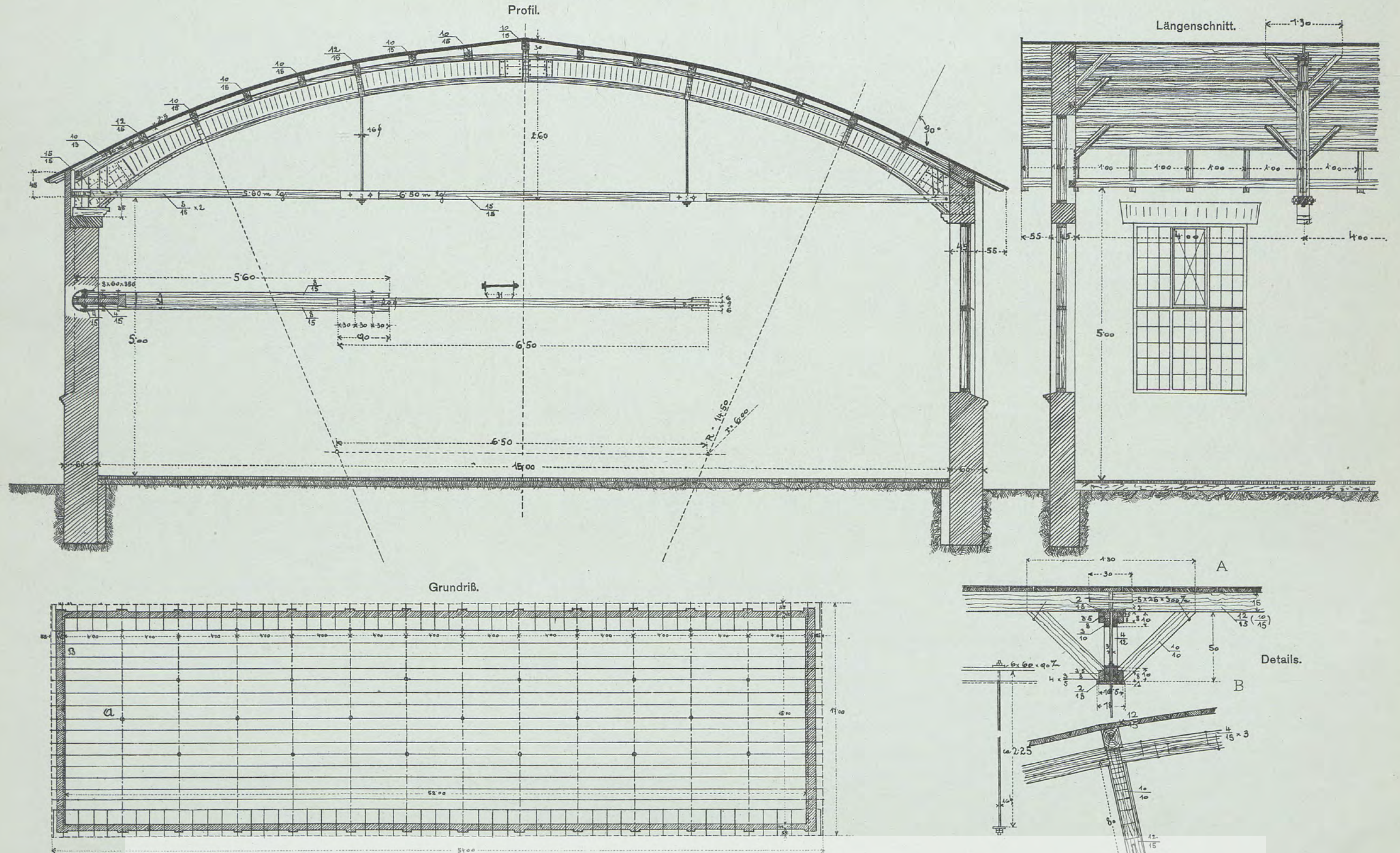

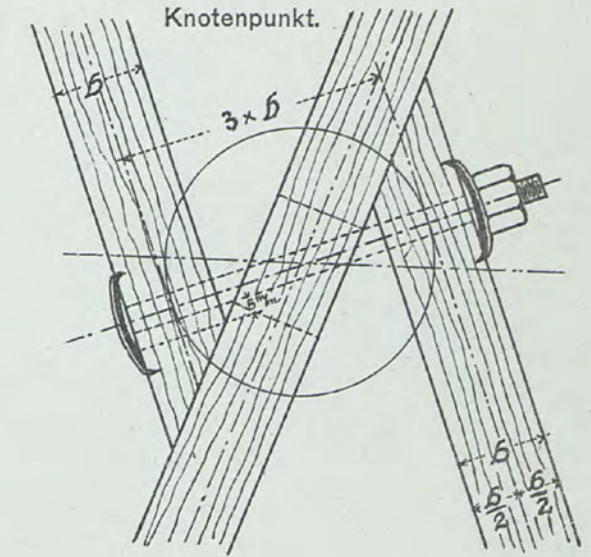
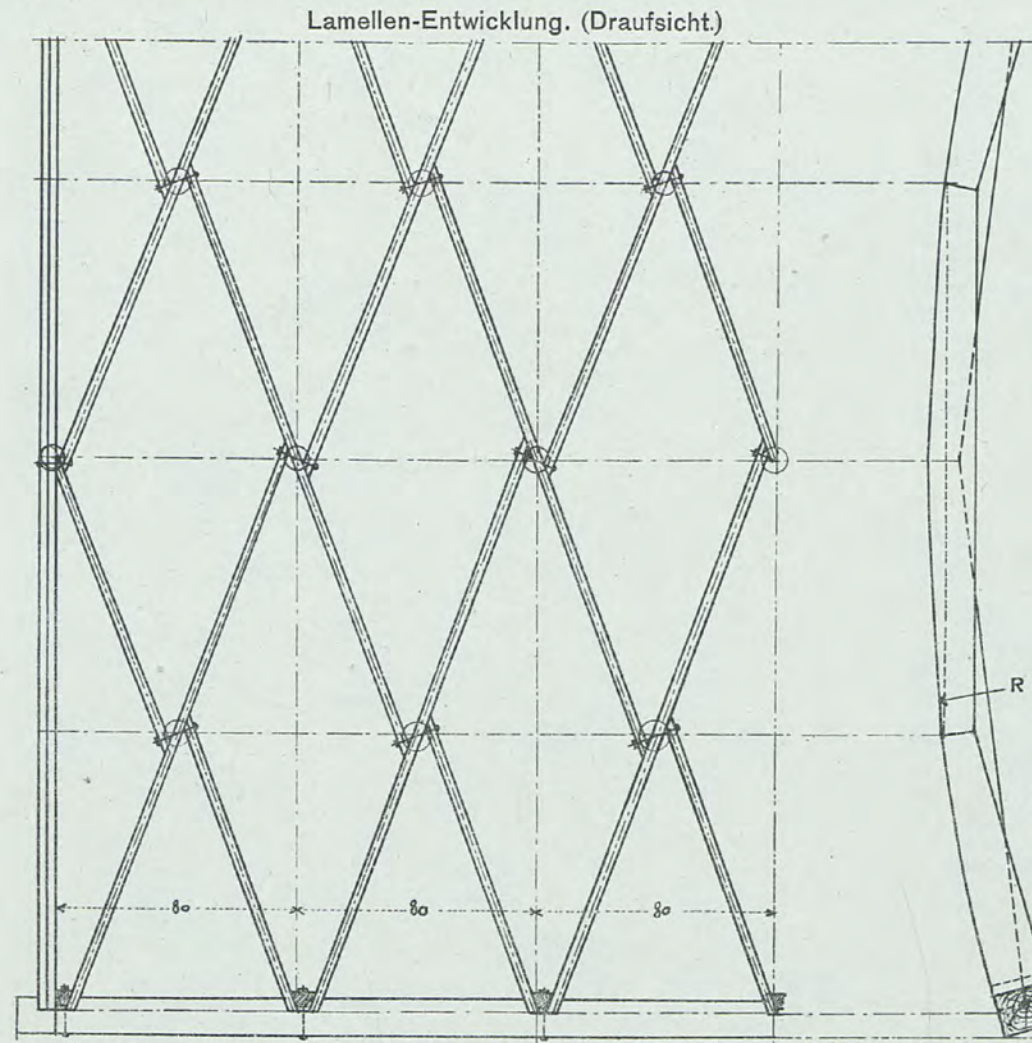
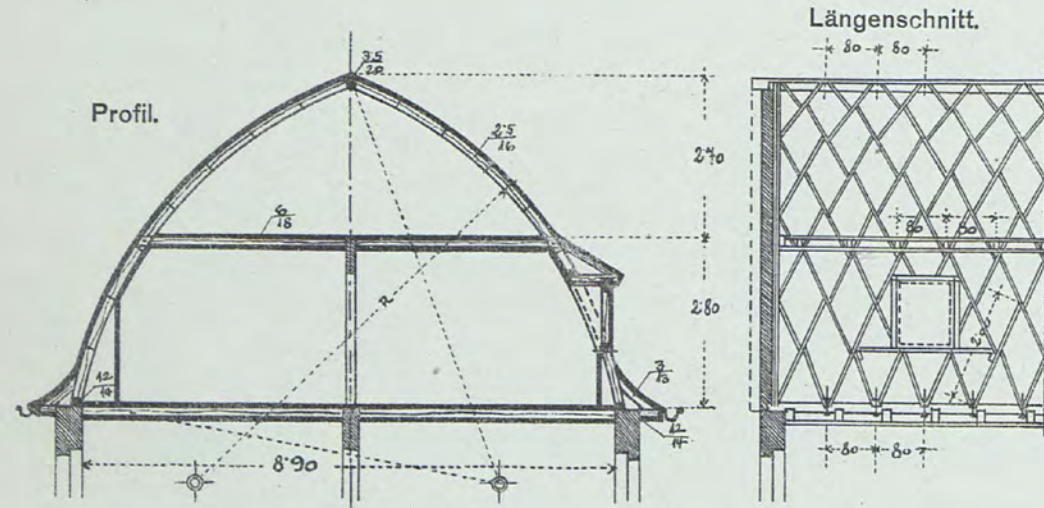

Profil über größere Spannweite.

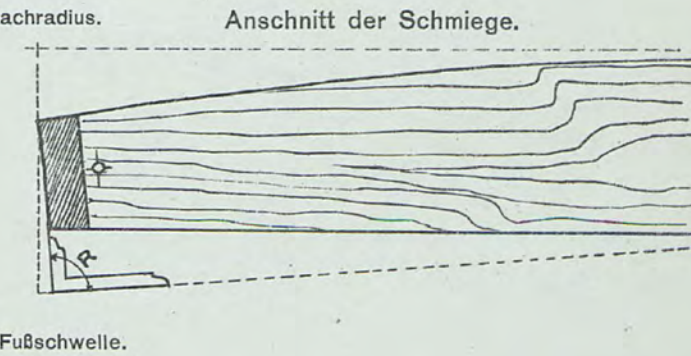
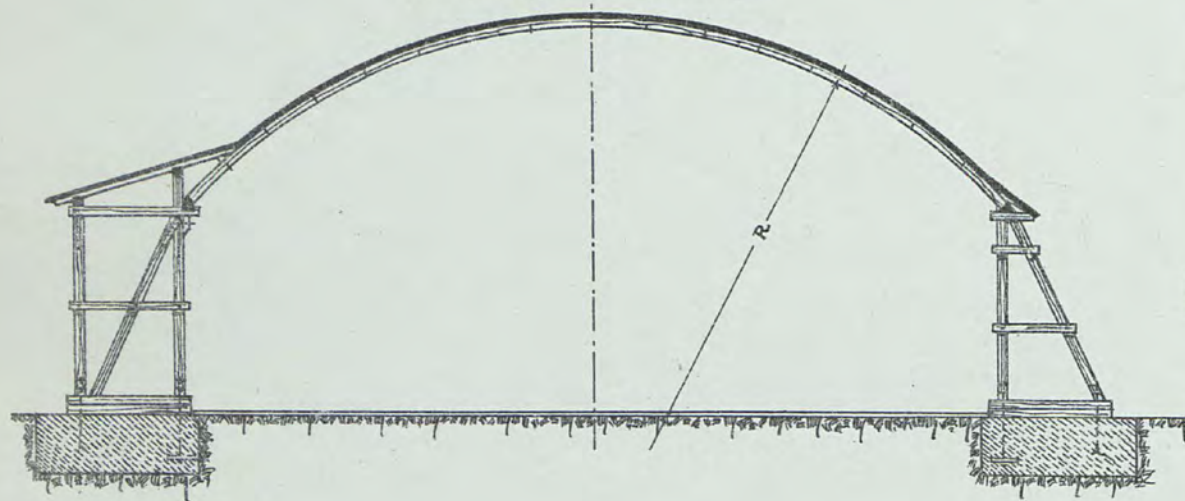

Profil für eine größere Industriehalle.

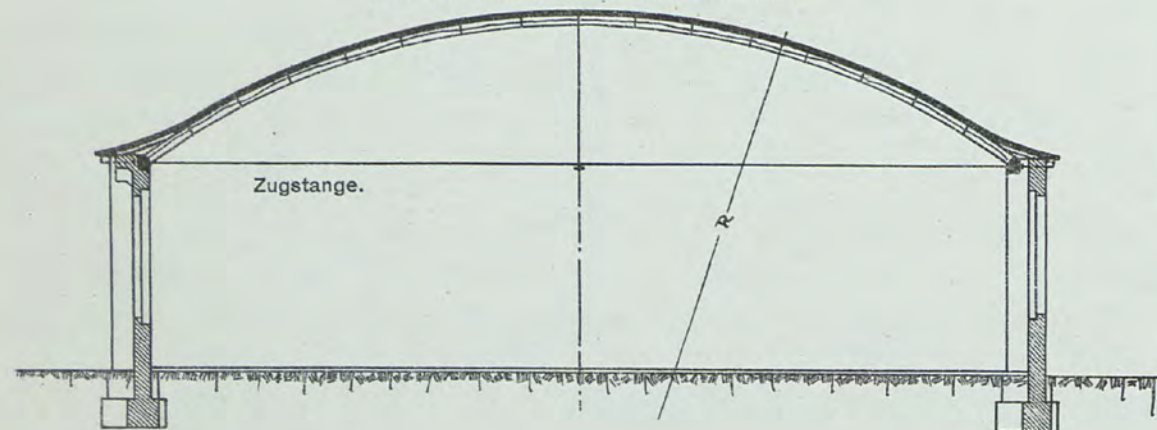

Befestigung der Kehlposten.

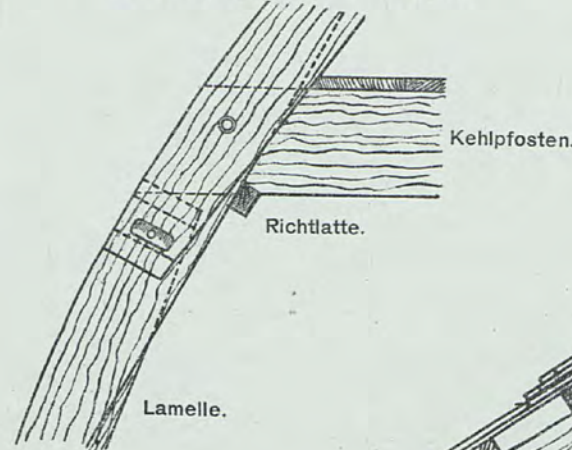

Gesimsausbildung.

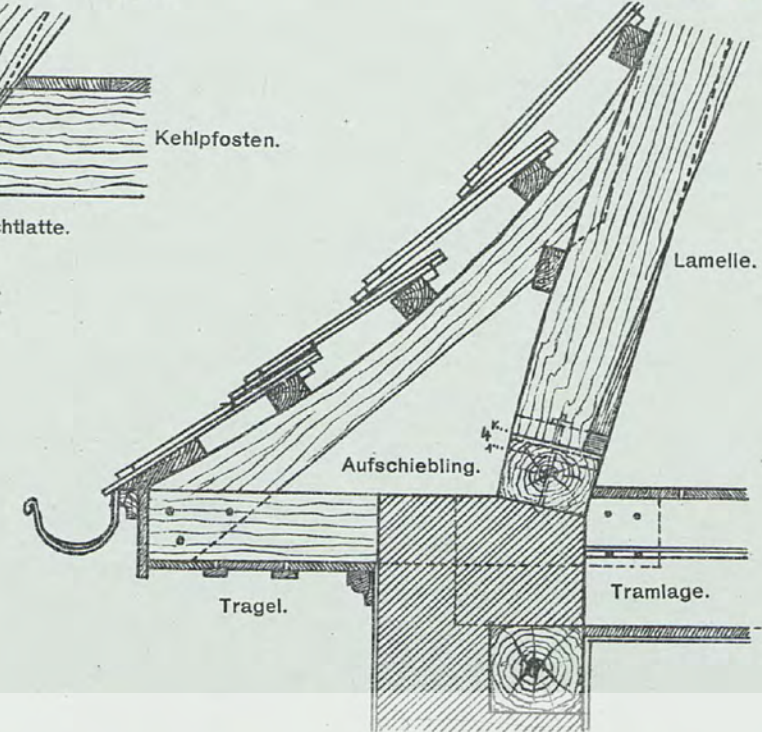

Firstpunkt. (Draufsicht.)

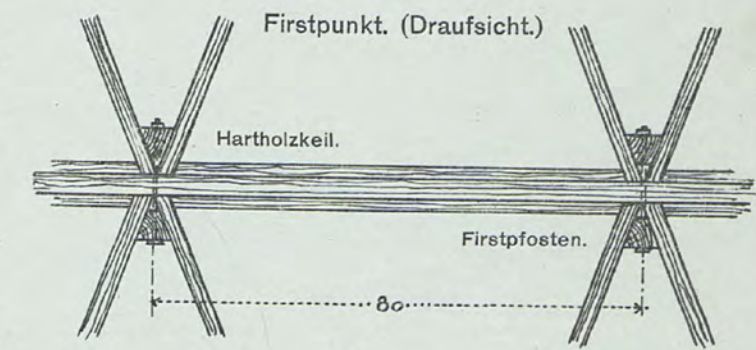

Fußpunkt.

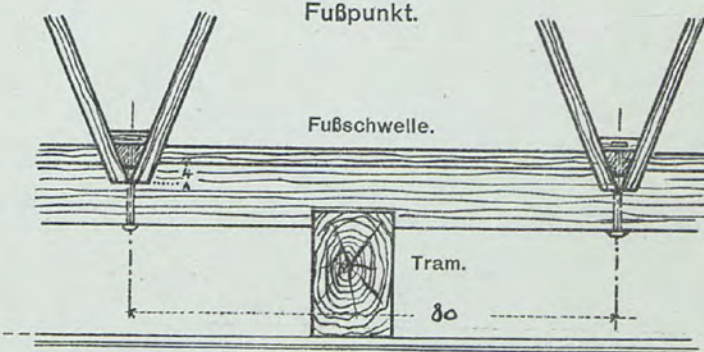

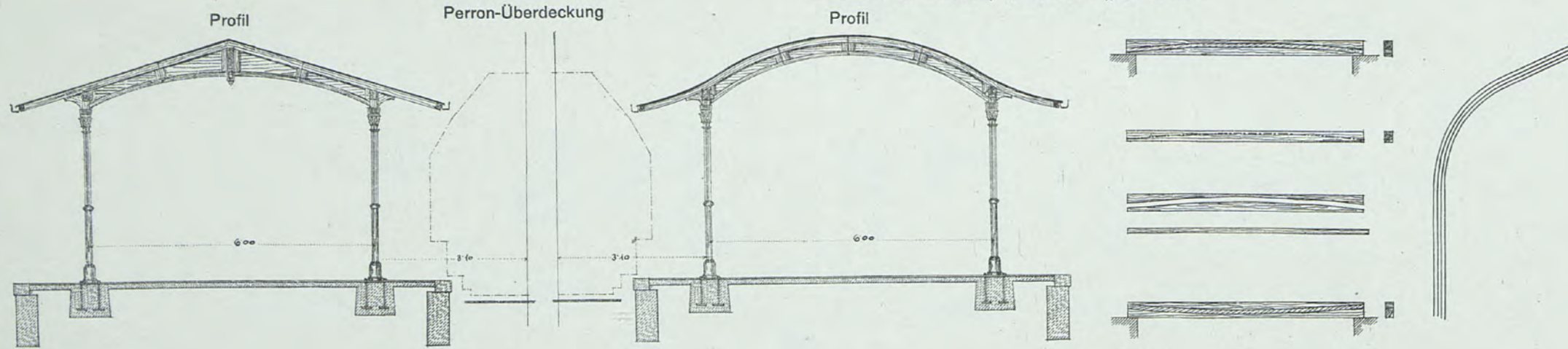

Erhöhung der Tragfähigkeit.

Ein **gerader Holztram** wird der Länge nach in parabolischer Krümmung durchgeschnitten und die auf diese Weise getrennten Teile werden nach Einfügung eines Langholzbrettes (weich oder Buche) durch ein in der Feuchtigkeit nicht lösliches Bindemittel (Topfenleim) unter Druck miteinander wiederum vereinigt.

Gebogene Holzbauteile für Dachbinder bestehen aus mehreren in gekrümmter Form (Schablone) gebogenen Langholzstäben, welche unter Zwischenfügung eines in Feuchtigkeit nicht löslichen Bindemittels (Topfenleim) zusammengepreßt werden. Nach dem Trocknen des Bindemittels behält der Bogen die ihm gegebene Form.

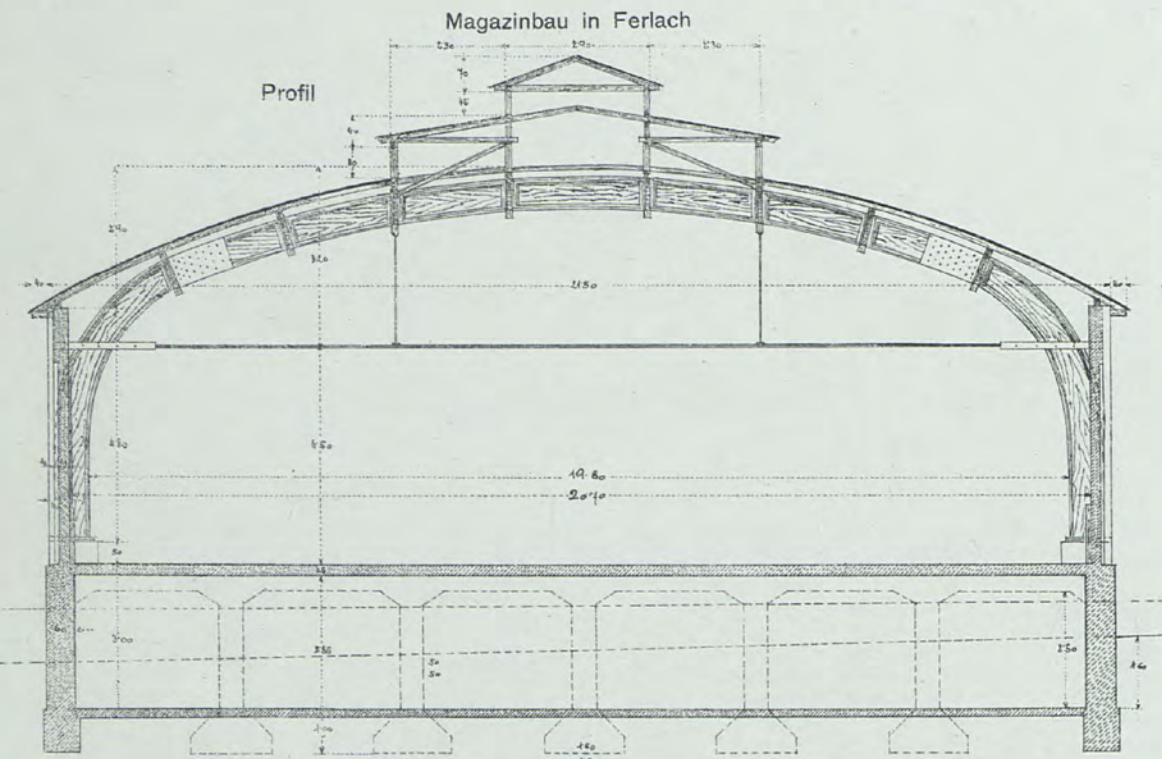

Sporthalle

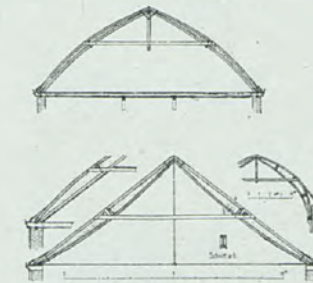
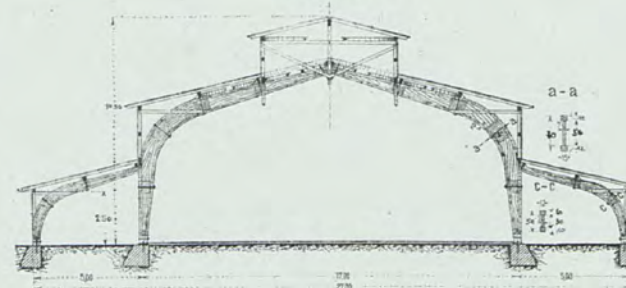

Verschiedene Arten von Dachbinder, System „Hetzer“

Zusammengesetzte Holzträger bestehen aus einer oberen und einer unteren Gurtung und einer Zwischenwand. Alle Bestandteile werden durch ein Bindemittel (Topfenleim) zu einem untrennbaren Ganzen vereinigt



Schaubild (flaches Dach)



Schaubild

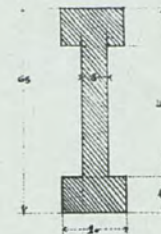
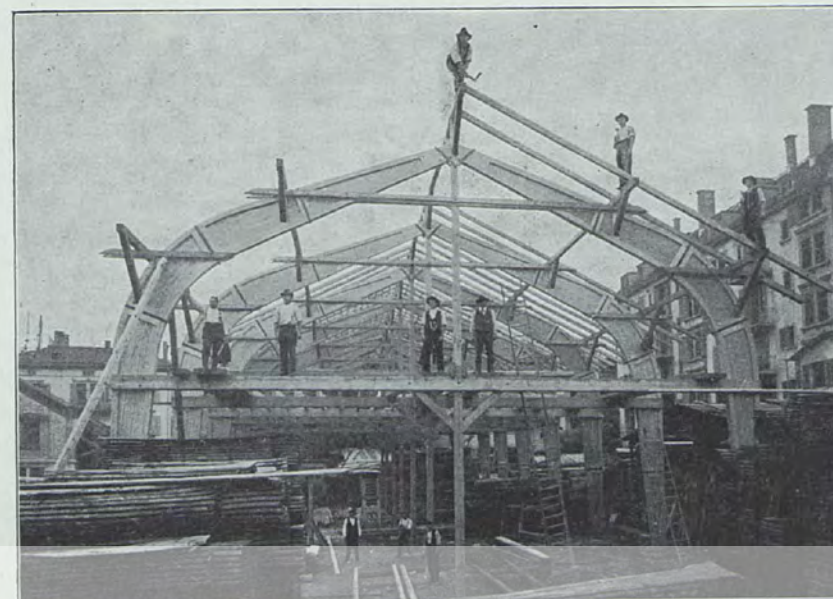

Schaubild

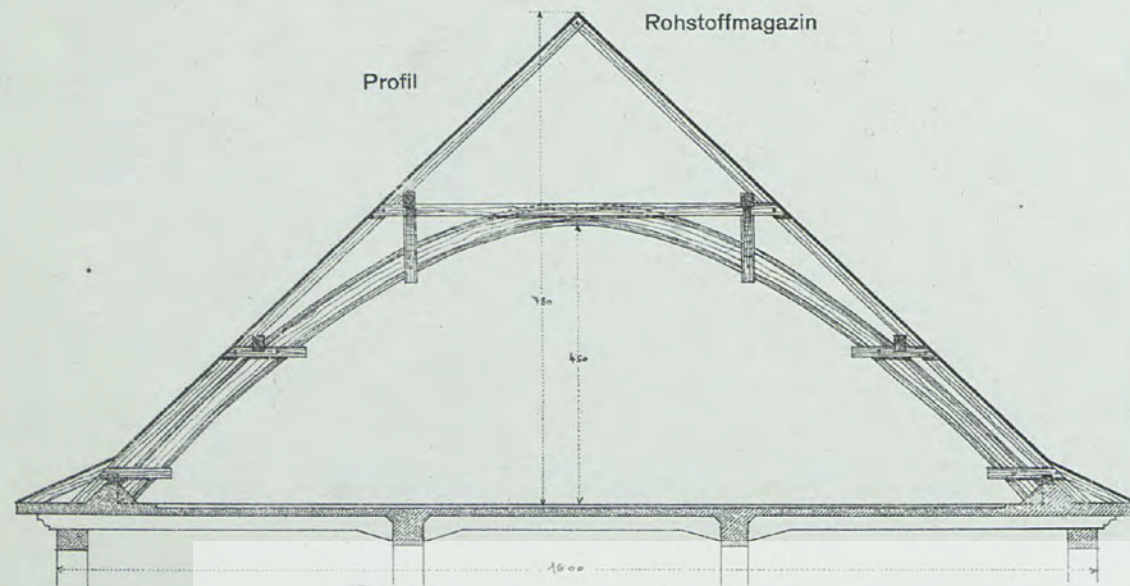
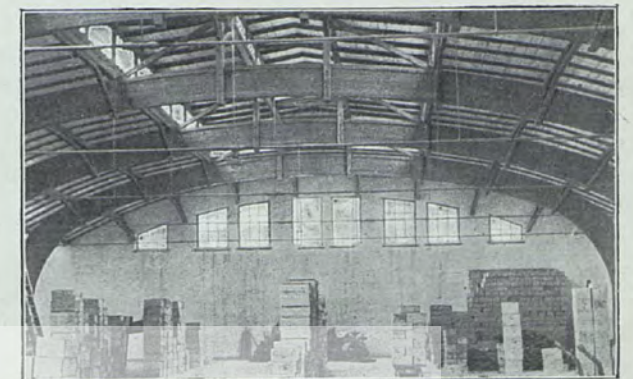

Industriehalle in Steg

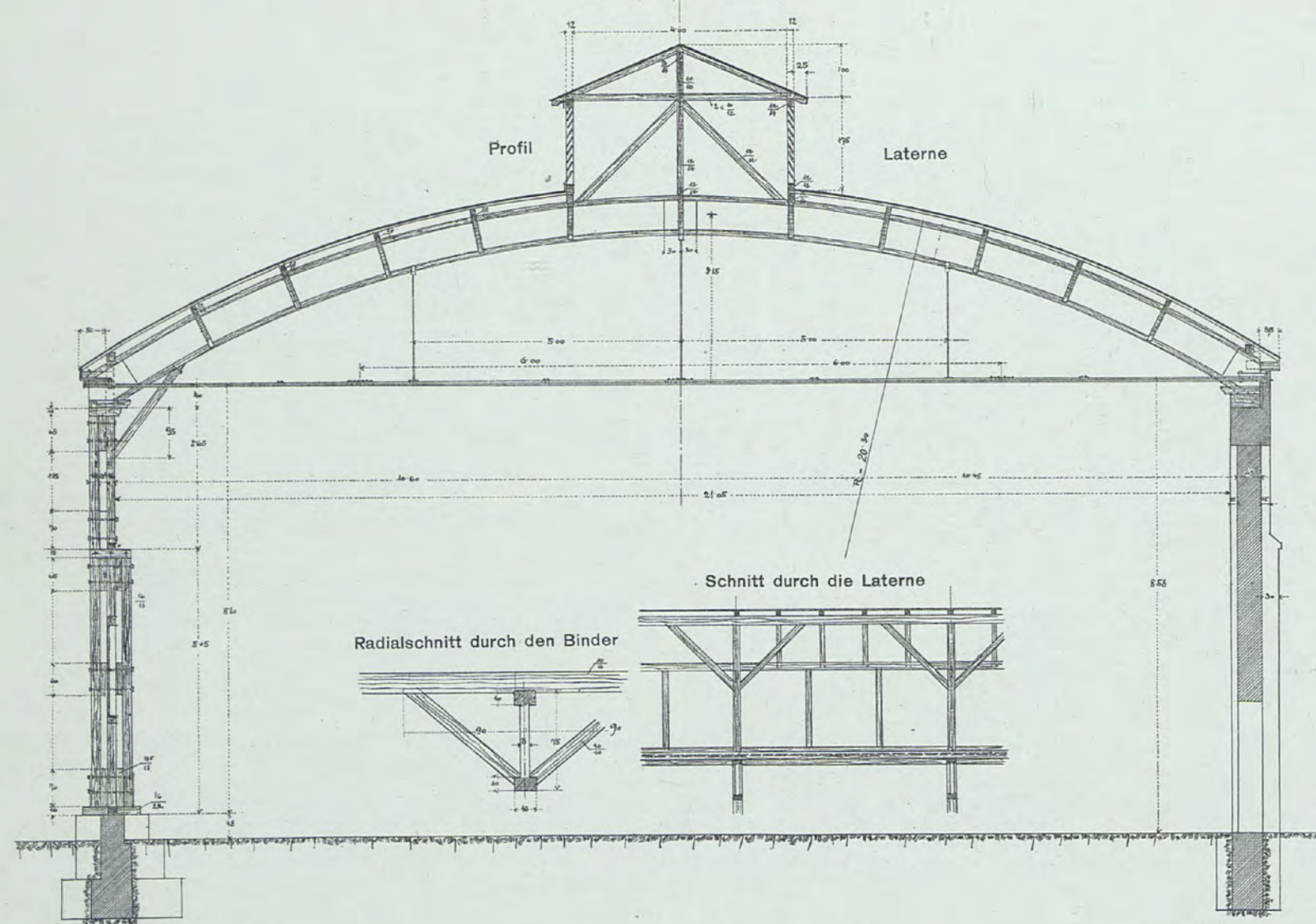

Binderfuß-Detail

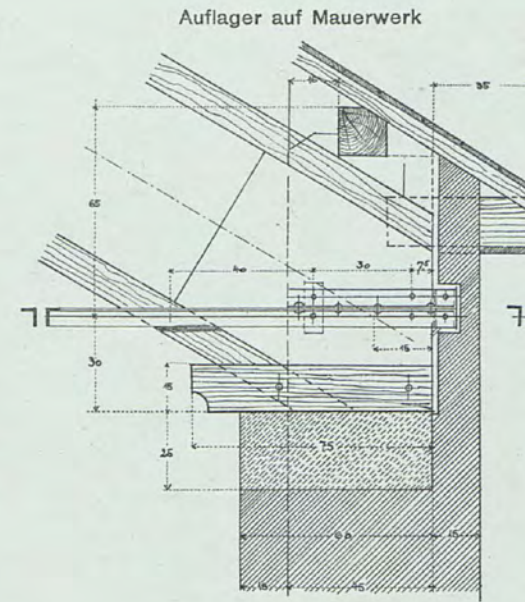

Auflager bei den Holzsäulen

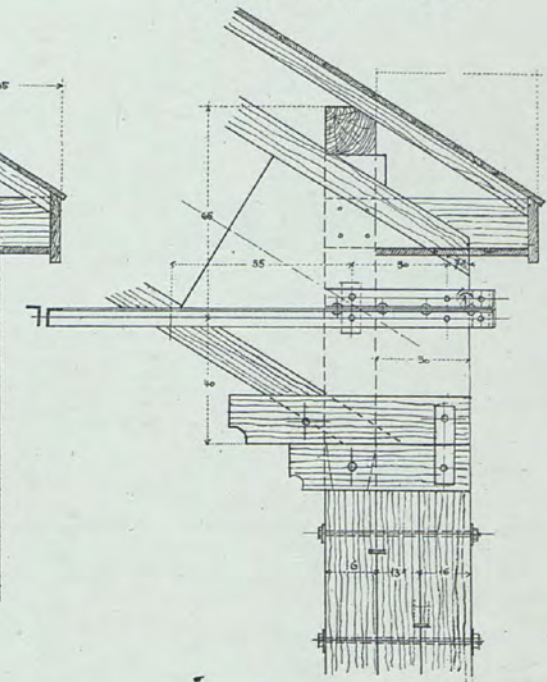

Wagschnitt



Wagschnitt

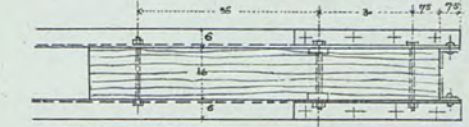

Laternen-Detail

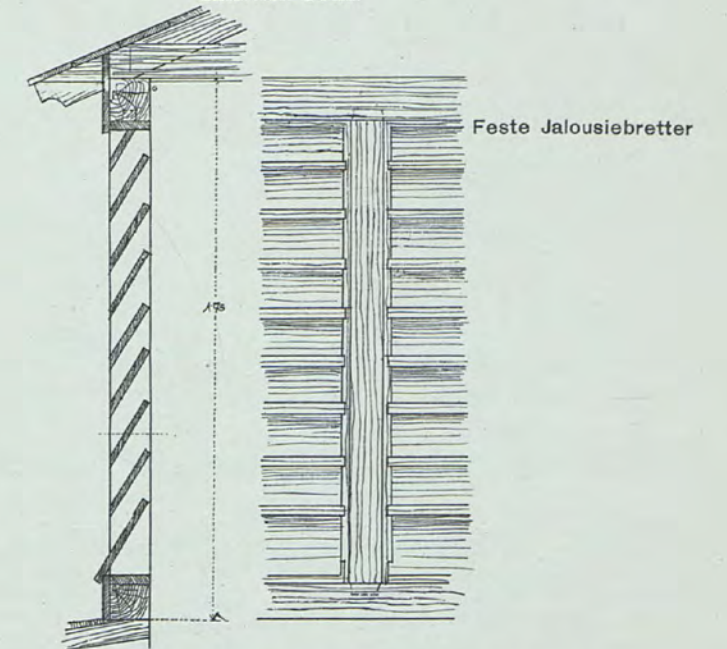

Radialschnitt durch den Binder

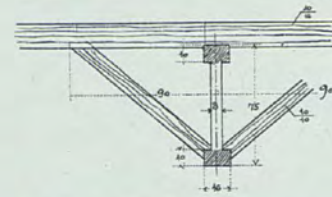

Schnitt durch die Laterne

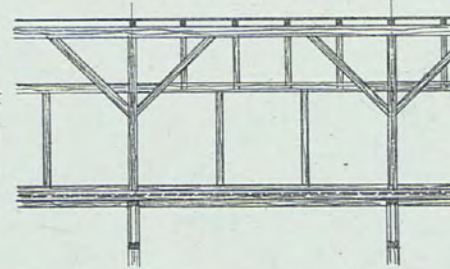

Schaubild



Grundriß mit Bindertellung

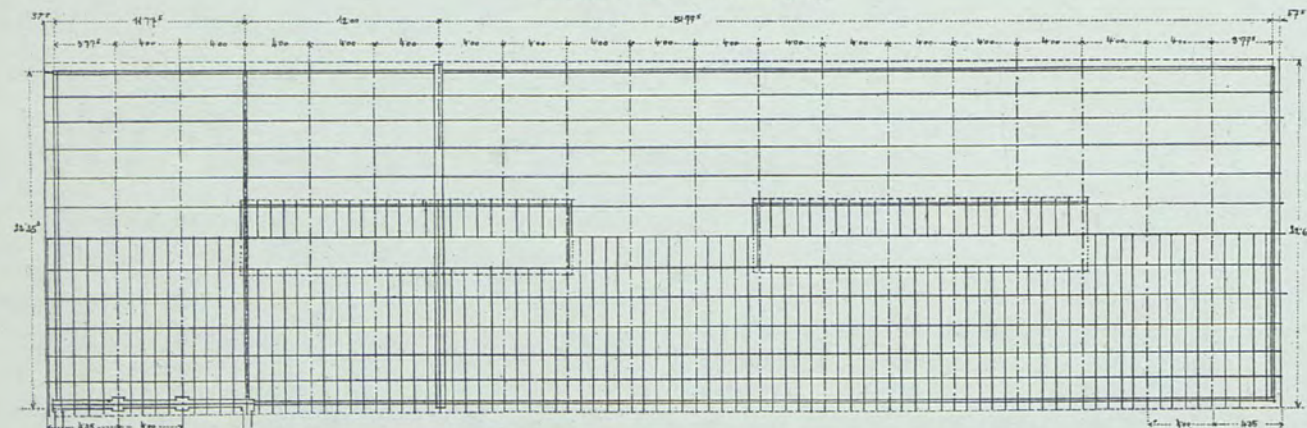

Satteldächer für verschiedene Dachneigungen und Spannweiten

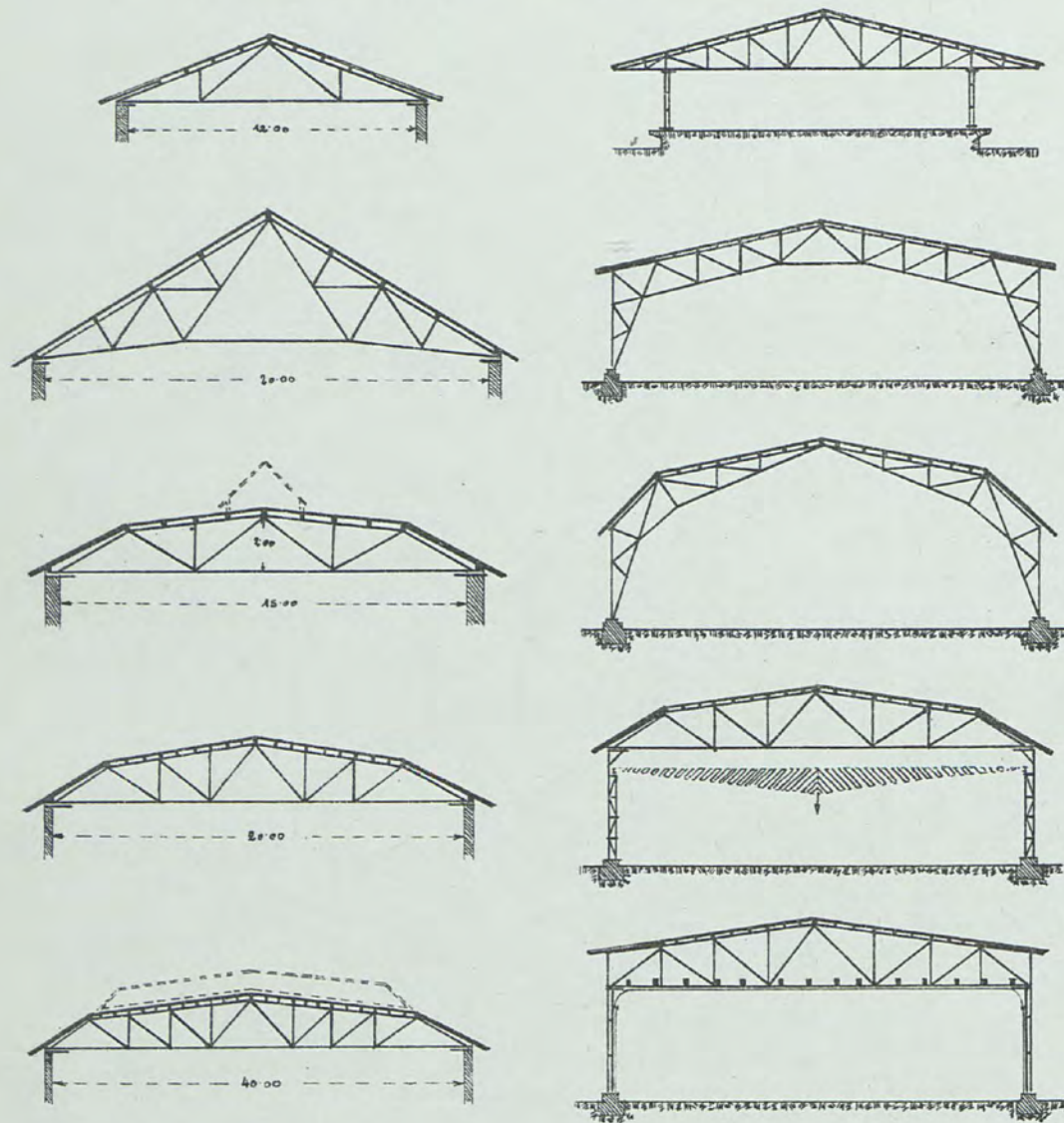

Die Holzverbindung durch geschlitzte Ringdoppel.

Die Hauptschwierigkeit in der Konstruktion freitragender hölzerner Fachwerksbinder liegt in den Knotenpunktanschlüssen der hölzernen Zugstäbe. Dieser Mangel wird beseitigt durch Anordnung geschlitzter Ringdoppel, welche die Übertragung größerer Zugkräfte ermöglichen.
Bis Spannweiten mit 50 t Diagonalzugkraft.

Vergleiche zwischen Ring-Scheiben- und Runddoppel sowie Schraubenbolzen

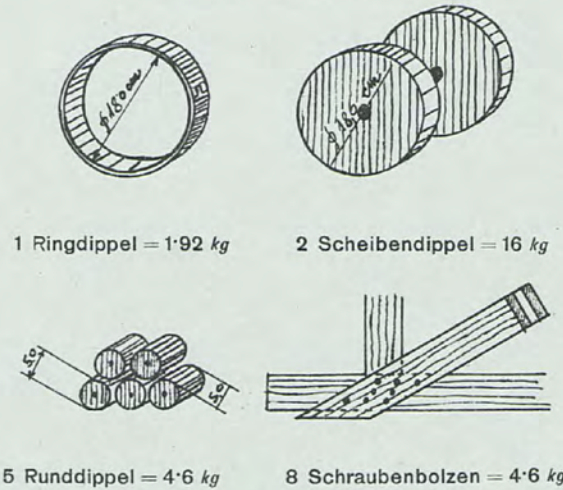

Ausstellungshalle in Aussig a. E. (Zimmerermeister Loebel)

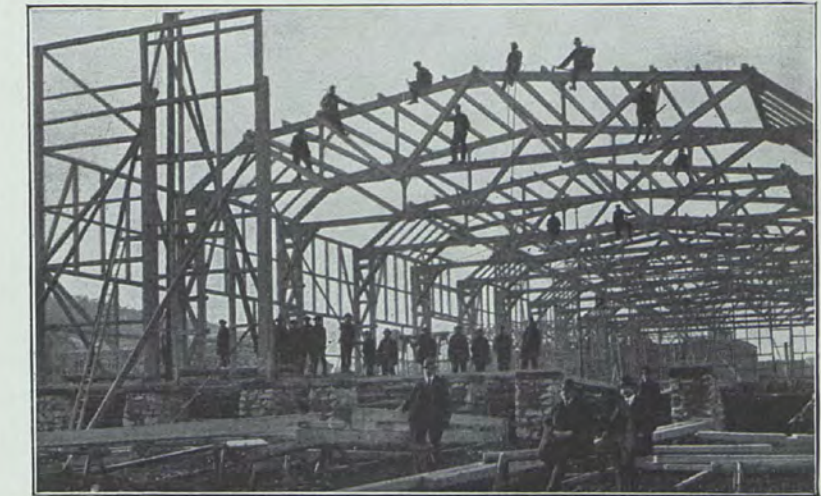

Dachbinder mit kittloser Oberlichte, Bauart „Tuchscherer“

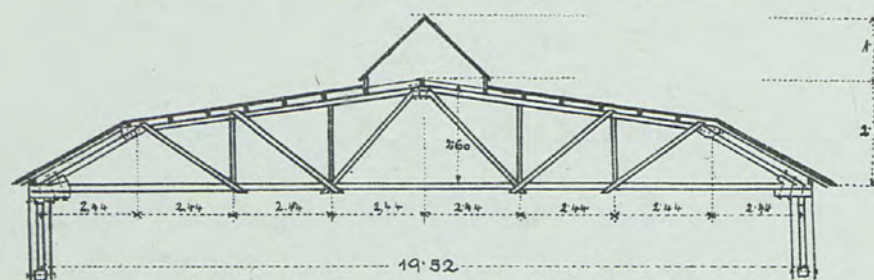

Der Vorteil des geschlitzten Ringdoppels besteht im geringsten Eisenmaterialverbrauch, der kleinsten Schwächung des Holzes, rasche Herstellung durch Fräsen der Ringnute und einfache Gesamtkonstruktion, welche statisch sicher bestimmt werden kann.
Beispielsweise wurde ein Hallendach 15 m breit, 30 m lang = 450 m² Grundfläche von 6 Arbeitern binnen 9 Tagen vollständig fertig gestellt.

Detail der kittlosen Verglasung Bauart „Tuchscherer“ am Saum

Offener Ringdoppel mit Schlitz

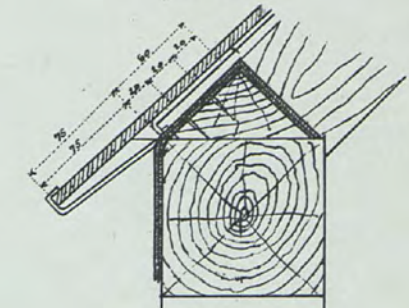
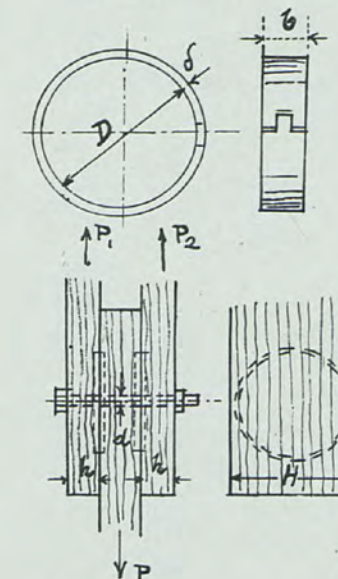

Beim Stoß der Glastafeln

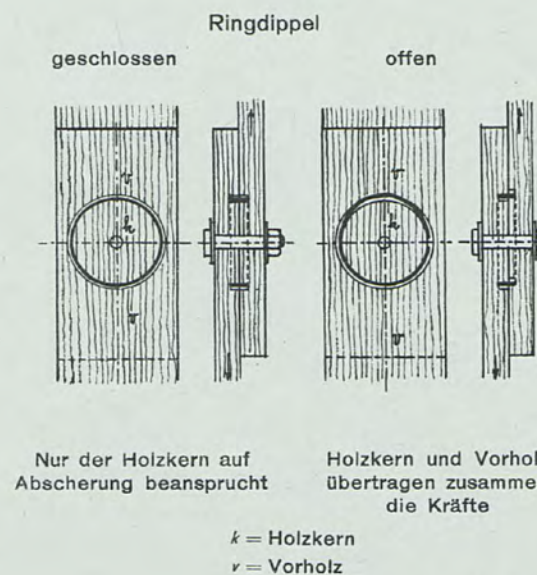
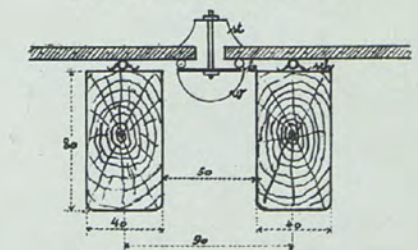

Nur der Holzkern auf Abscherung beansprucht
Holzkern und Vorholz übertragen zusammen die Kräfte

k = Holzkern
v = Vorholz

In der Praxis werden 6 Ringe verschiedener Weite gebraucht

st = Stoßdeckkappe
b = Bleikabel
w = Wasserabföhrinne
sch = Schweißwasserrinne

Entwurf: } CARL TUCHSCHERER, Spezial-„Holzbau“-Geschäft,
Ausführung: } Wien VII.

DER ZIMMERER-MEISTER, I. TEIL, Nr. 69
NORMALBINDER DER BAUART „TUCHSCHERER“ FÜR SPANNWEITEN VON 15'00—40'00 m.
Nr. 69.

Professor und Stadtzimmerer-Meister A. BAUDOIN, Wien.

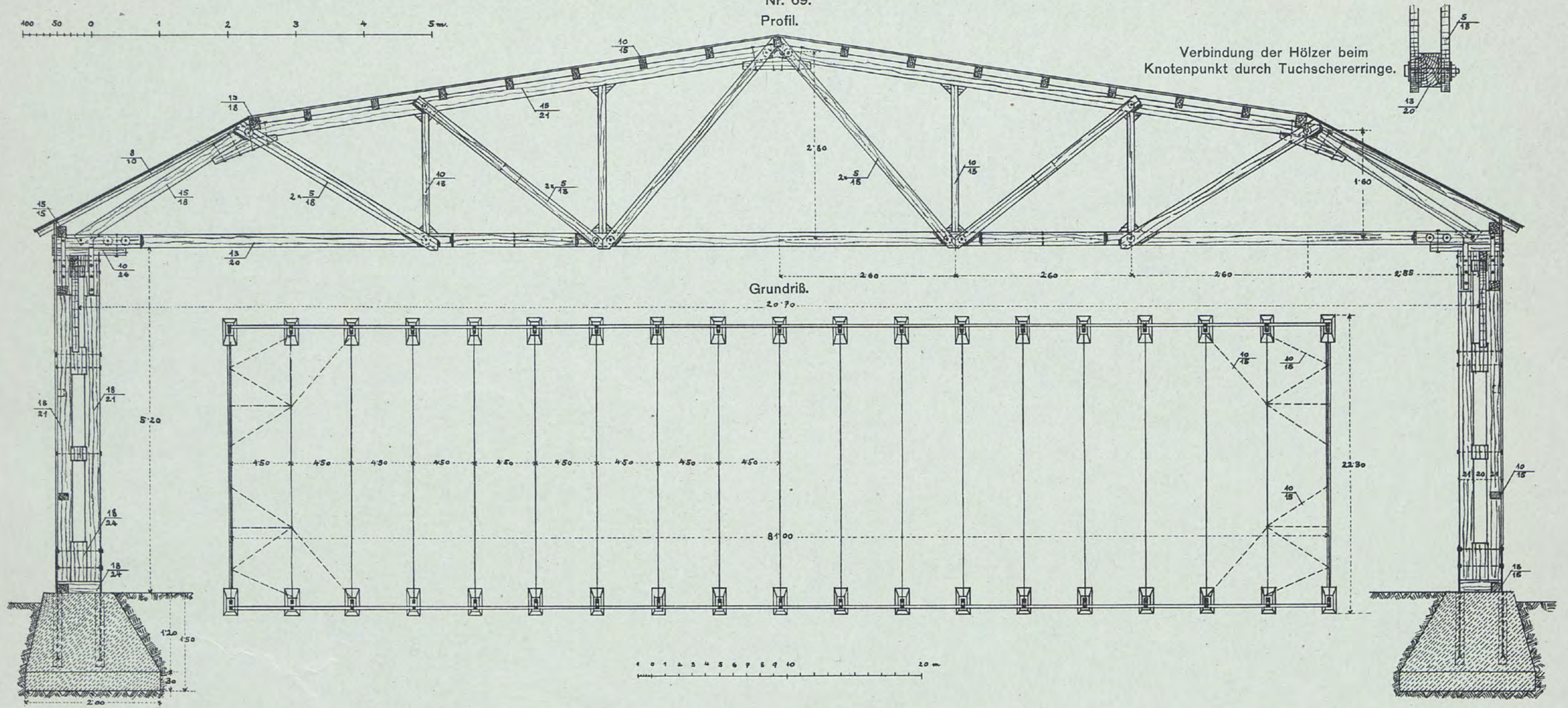

Waggonhalle für die elektrische Stadtbahn, Wien XIII.

Querschnitt.

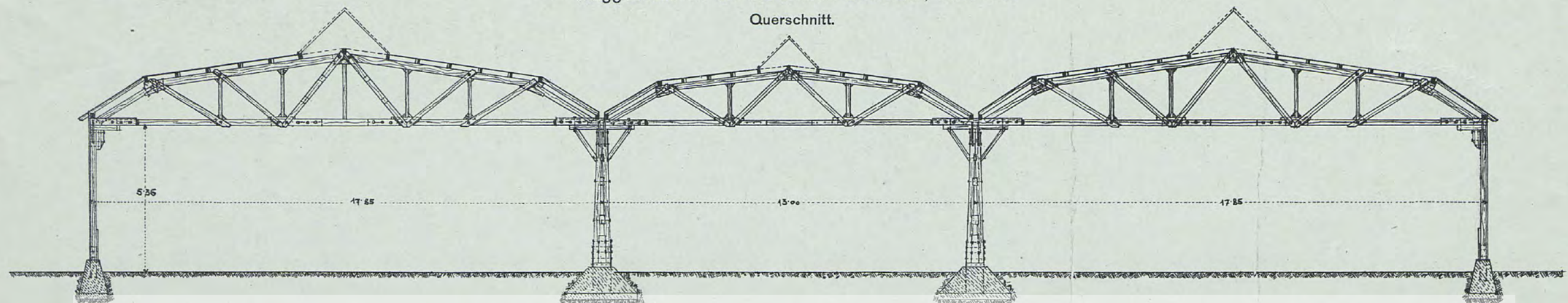

Messehalle in Gelsenkirchen → Ansicht des Gerippes



Messehalle in Breslau

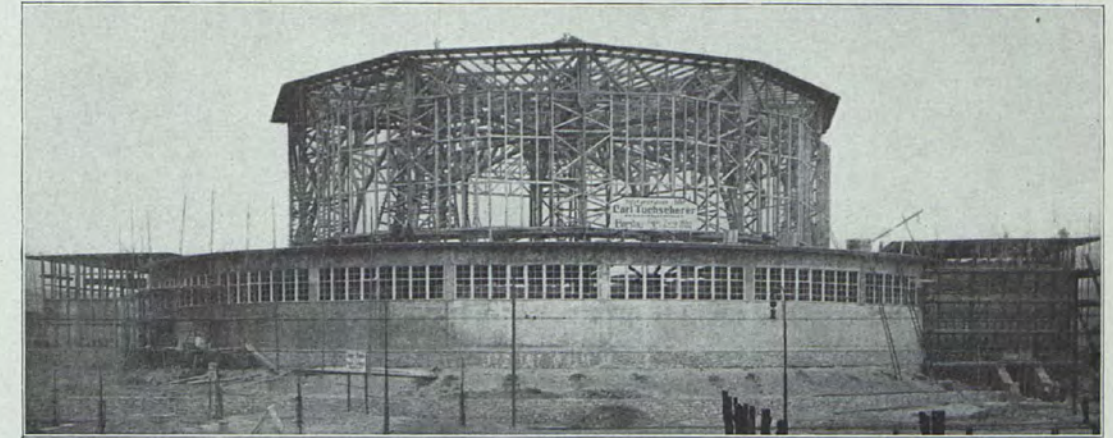

Radiohalle Berlin — Außenansicht



Radiohalle Berlin — Innenansicht des Gerippes



Radiohalle Berlin — Innenansicht der verkleideten und verputzten Halle



Querschnitt durch die Großgarage der Gemeinde Wien

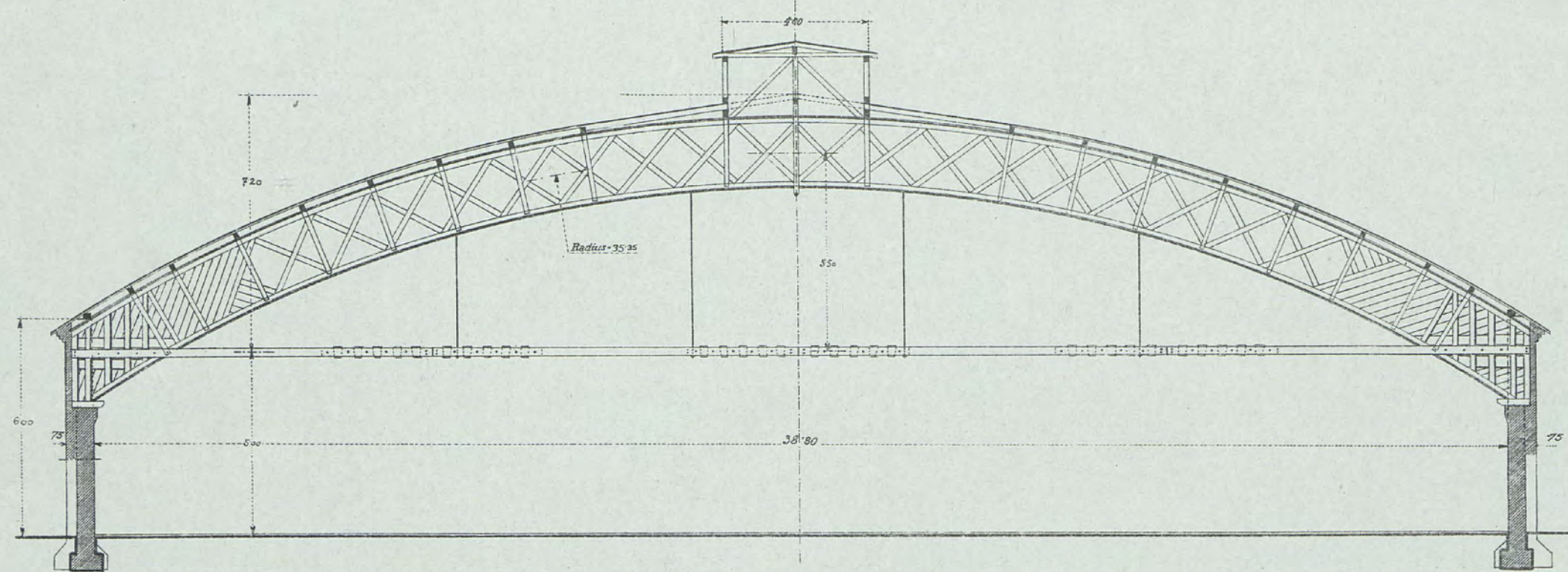

Binderquerschnitt

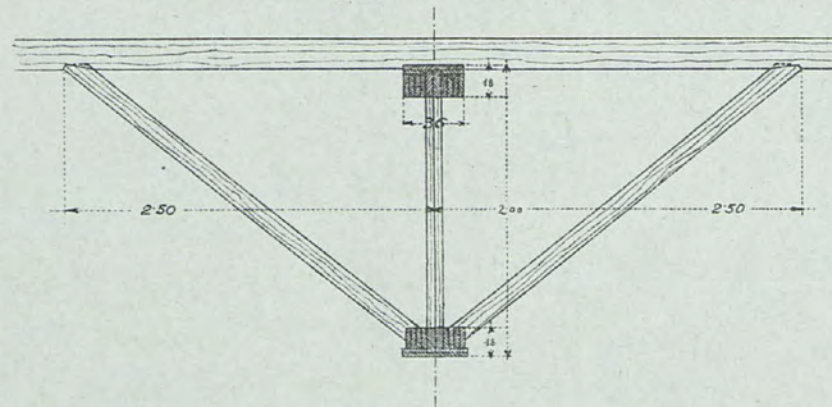

Detail der Spannstange



Wagenhalle Heiligenstadt der Gemeinde Wien



Wagenhalle Ottakring der Gemeinde Wien



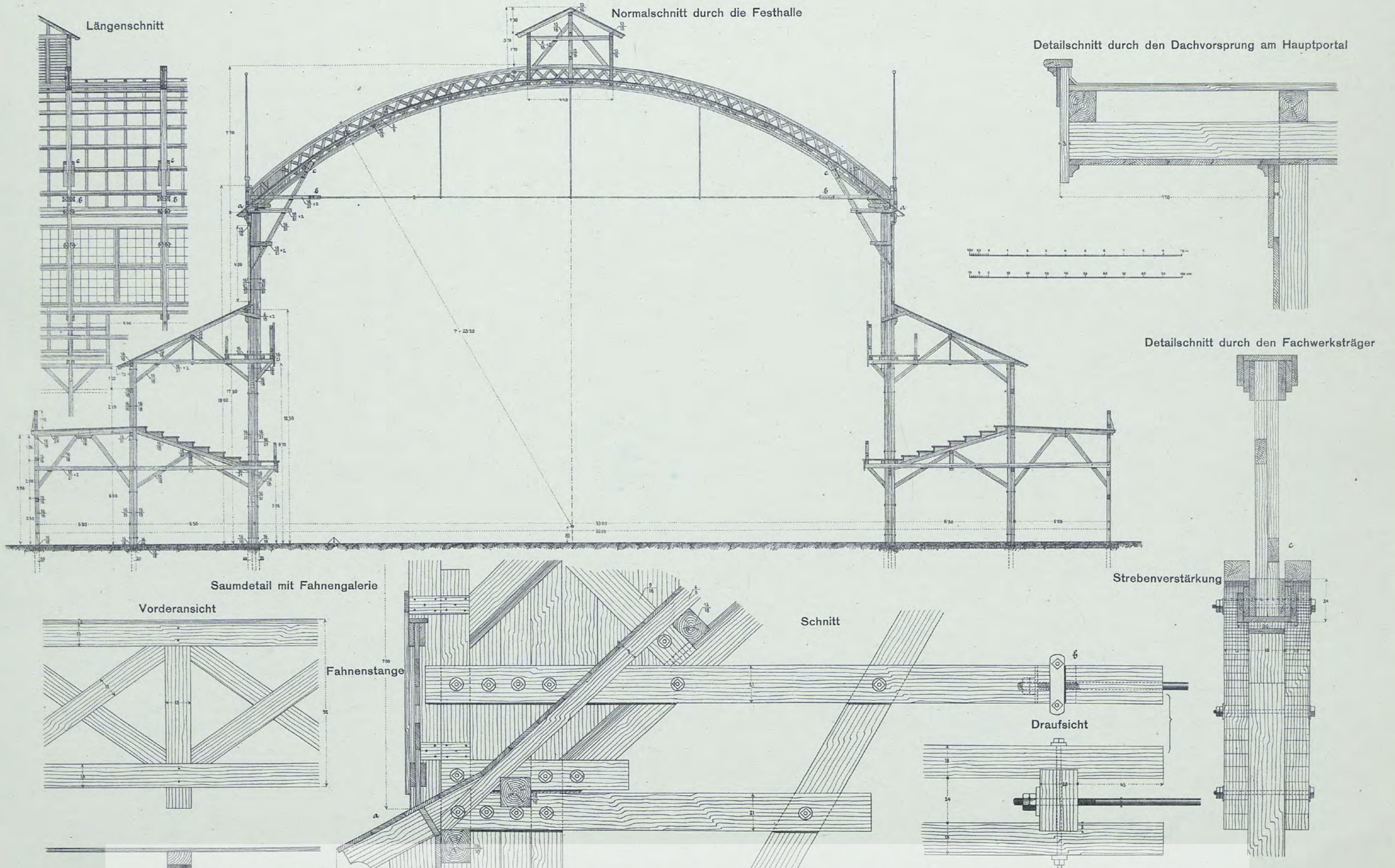

ARANEO-TECHNIK. EINE ERRUNGENSCHAFT DER NORMALISIERUNG IM BAUWESEN.

ZERLEGBARE ELEMENTENBINDER (SYSTEM „LENZ“)

Satteldachbinder für verschiedene Dachneigungen und Spannweiten

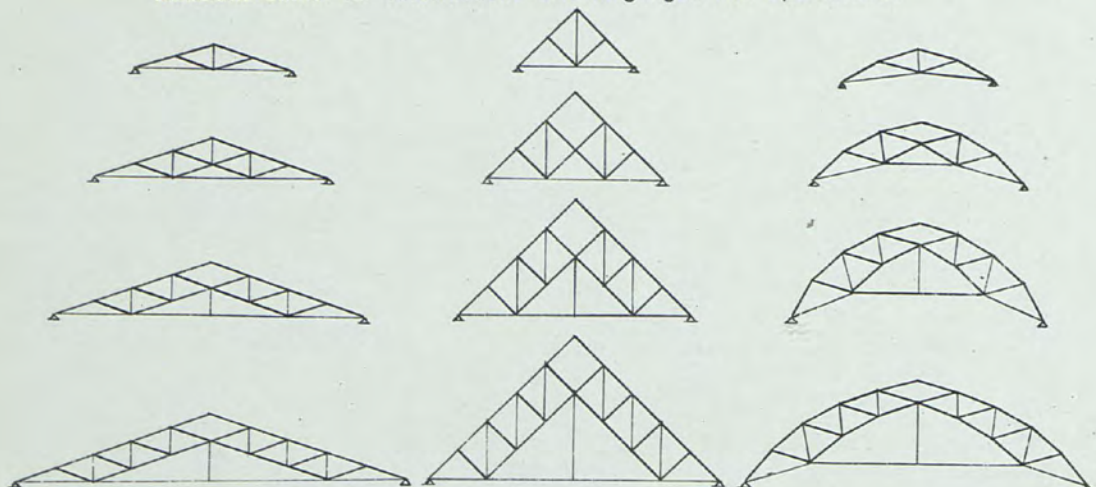

Güterschuppen mit Satteldach

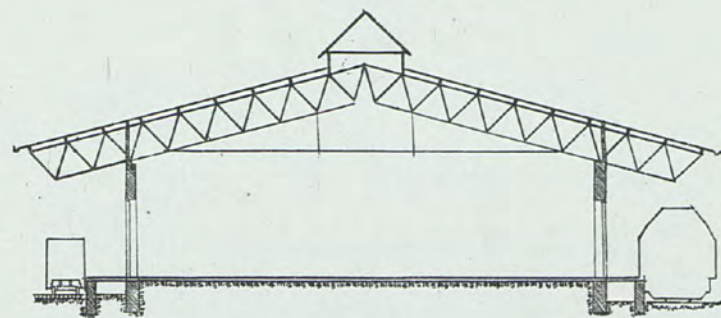

Provisorische Überdeckung von Bauten während der Ausführung

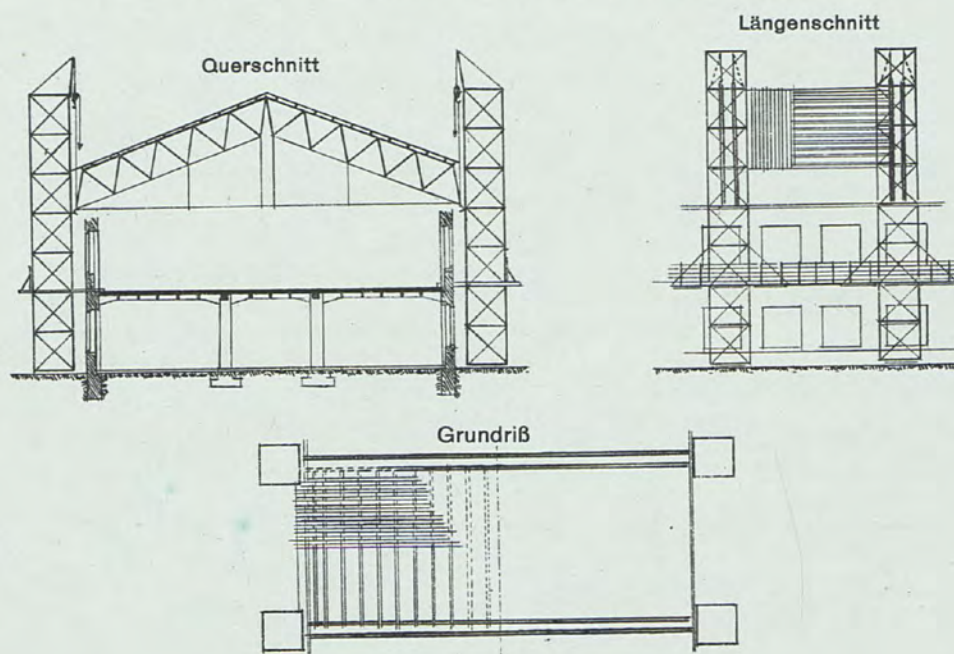

Kirchendachstuhl

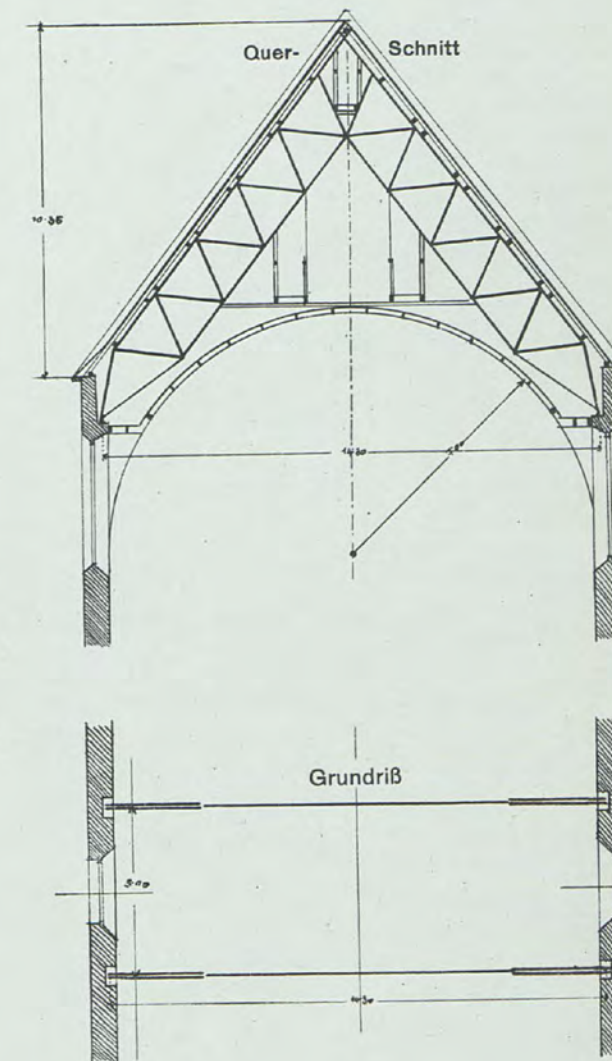

Inselperron-Überdeckung

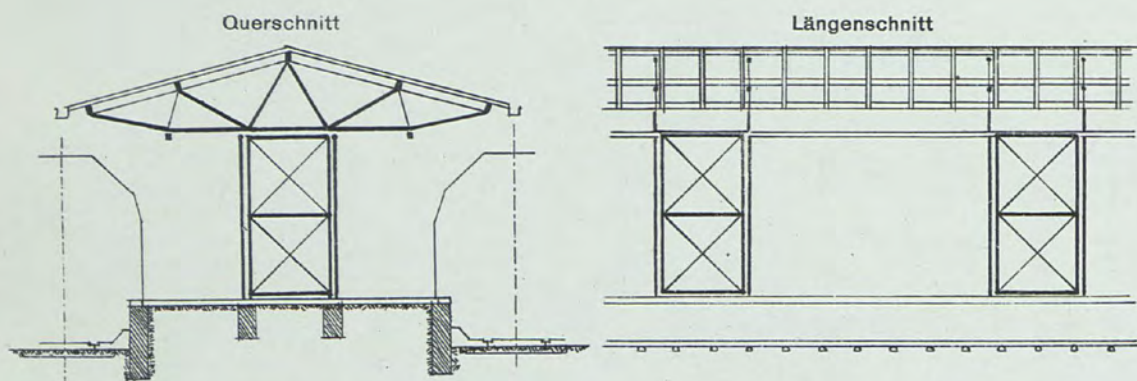

Tragwerke für Industrieanlagen

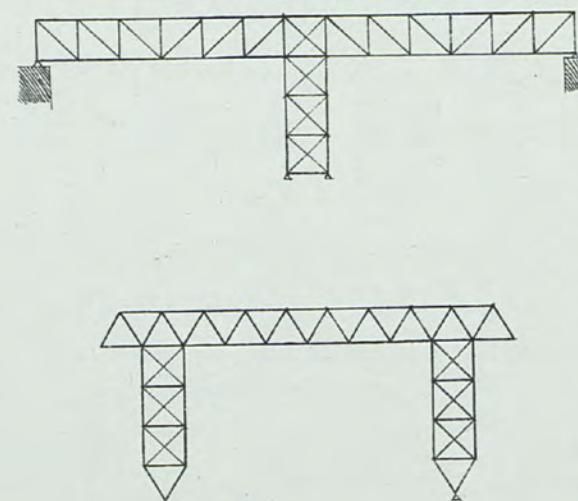

Doppelhalle mit Anbau

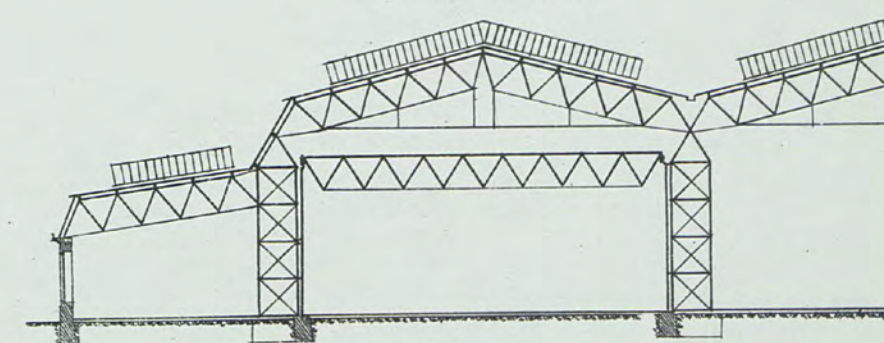

Fabrikshalle mit seitlichen Anbauten

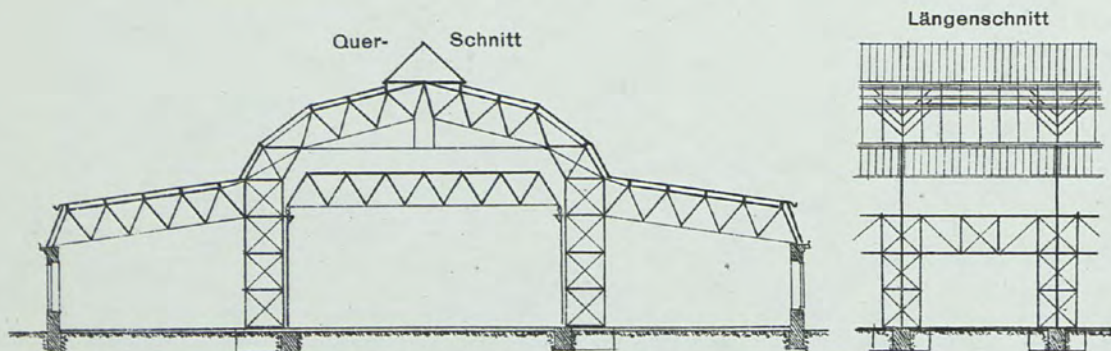

1. DER ARANEOSTAB, 2. DER ARANEOKNOTEN, 3. DAS AUFLAGER

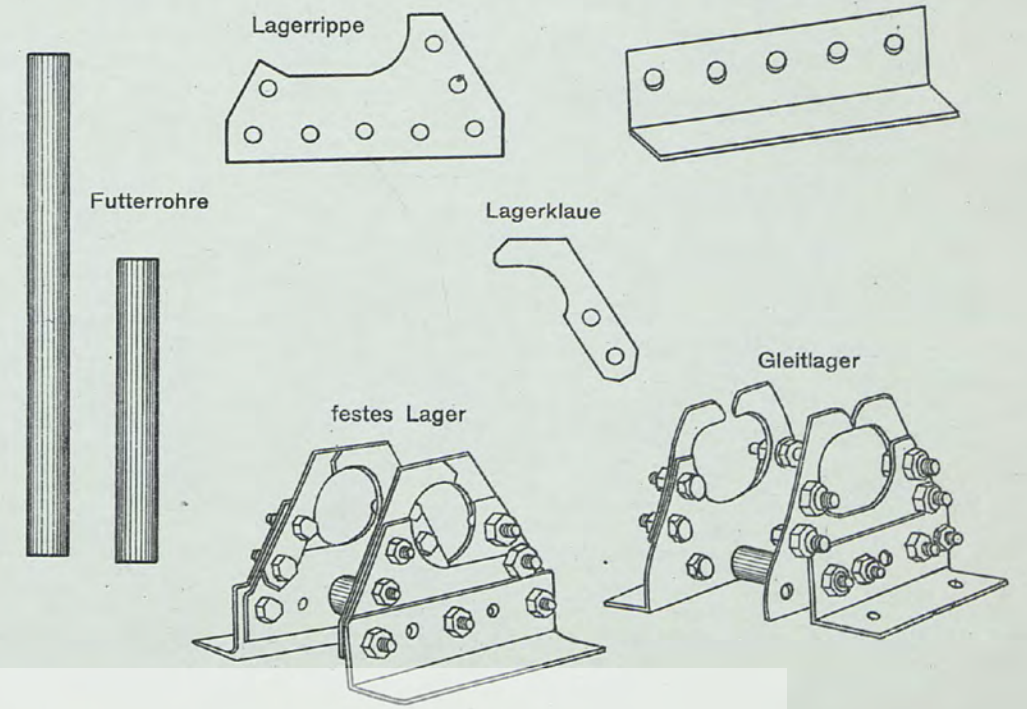
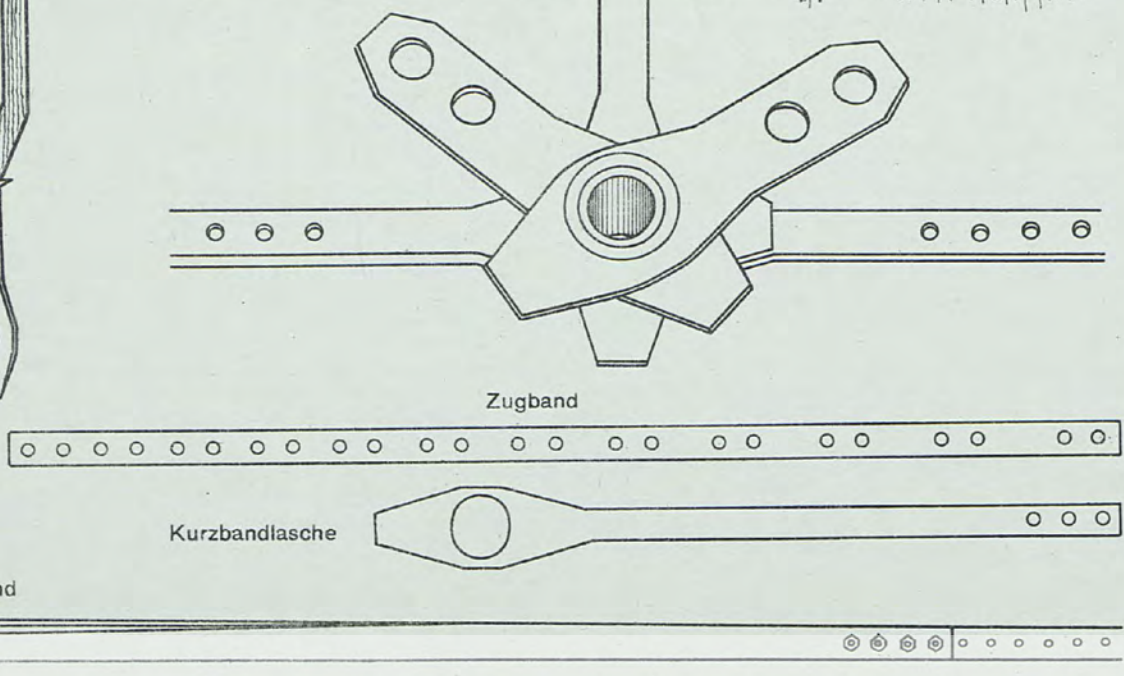
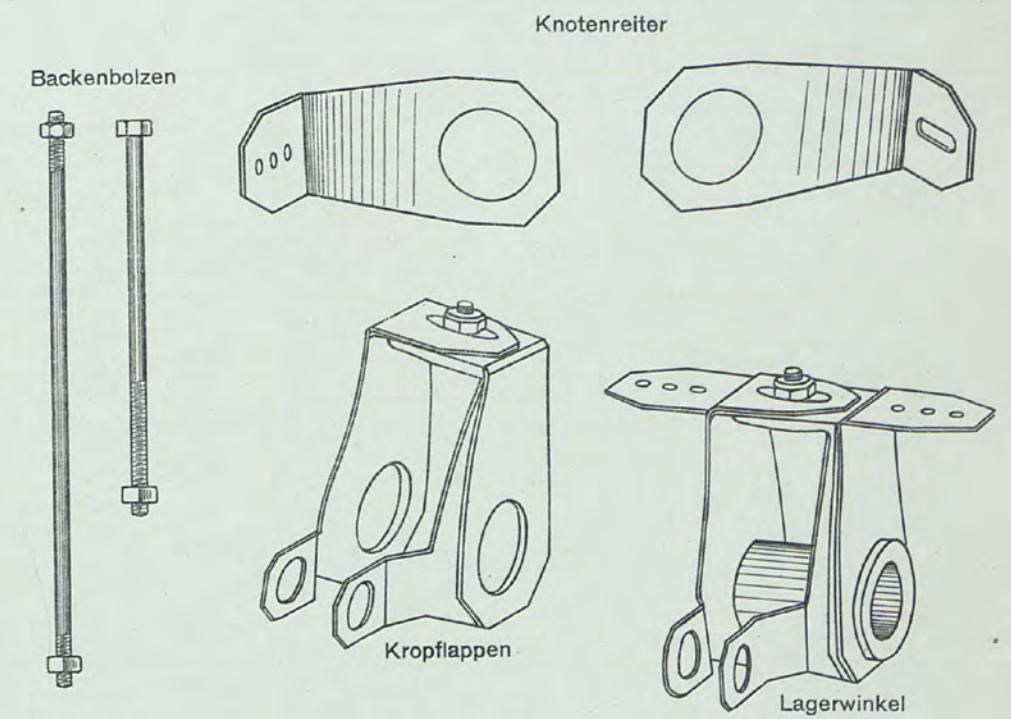
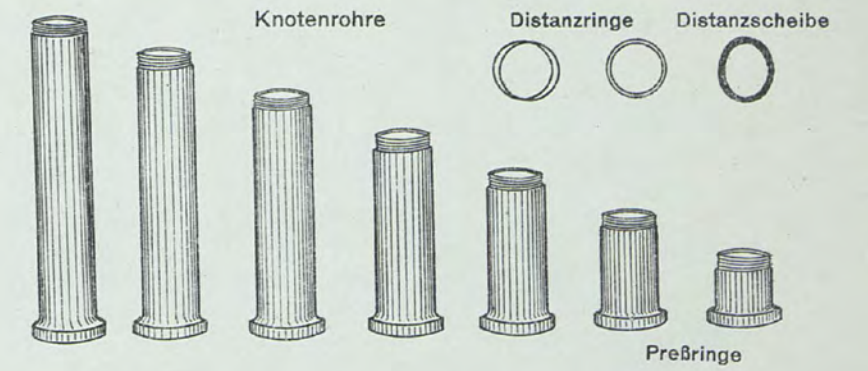
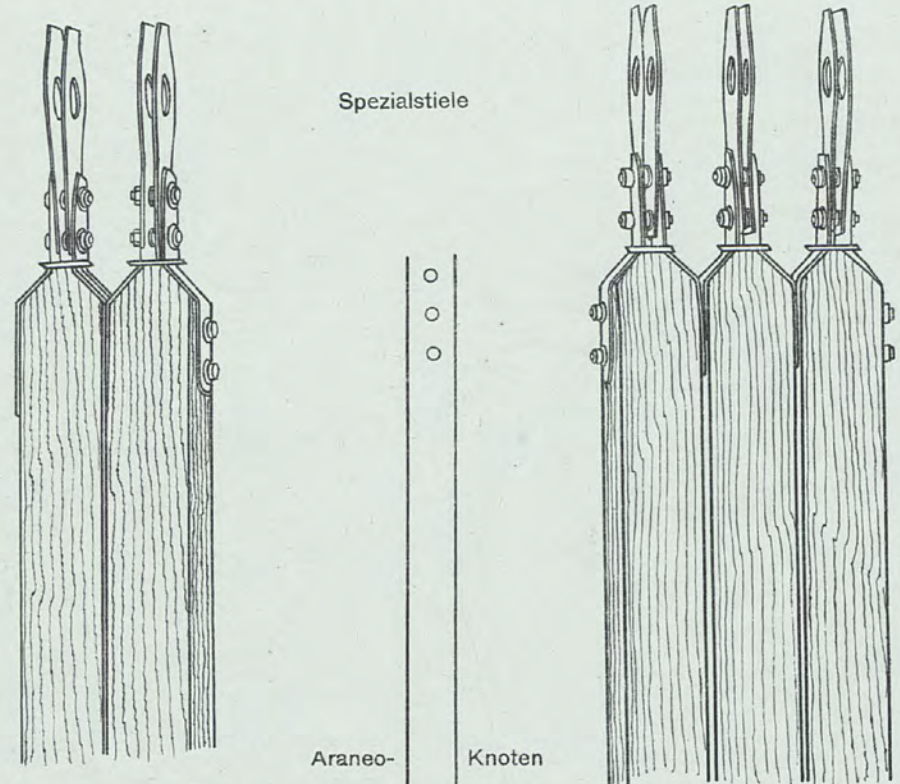
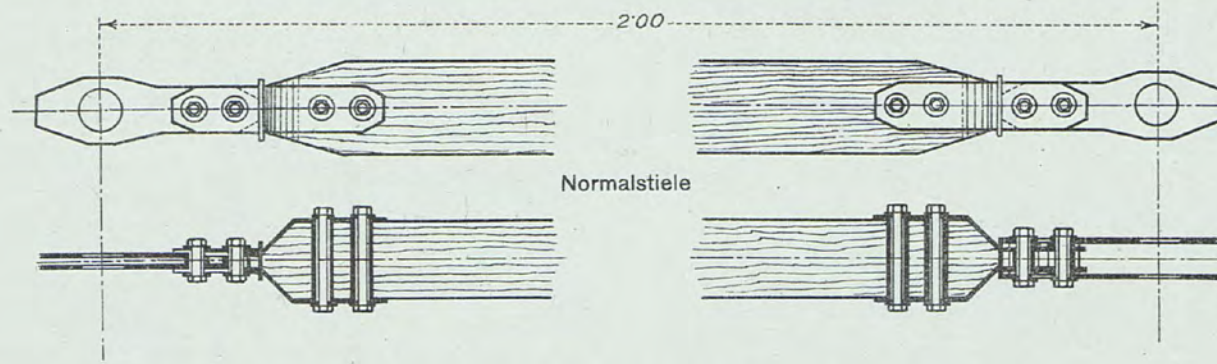
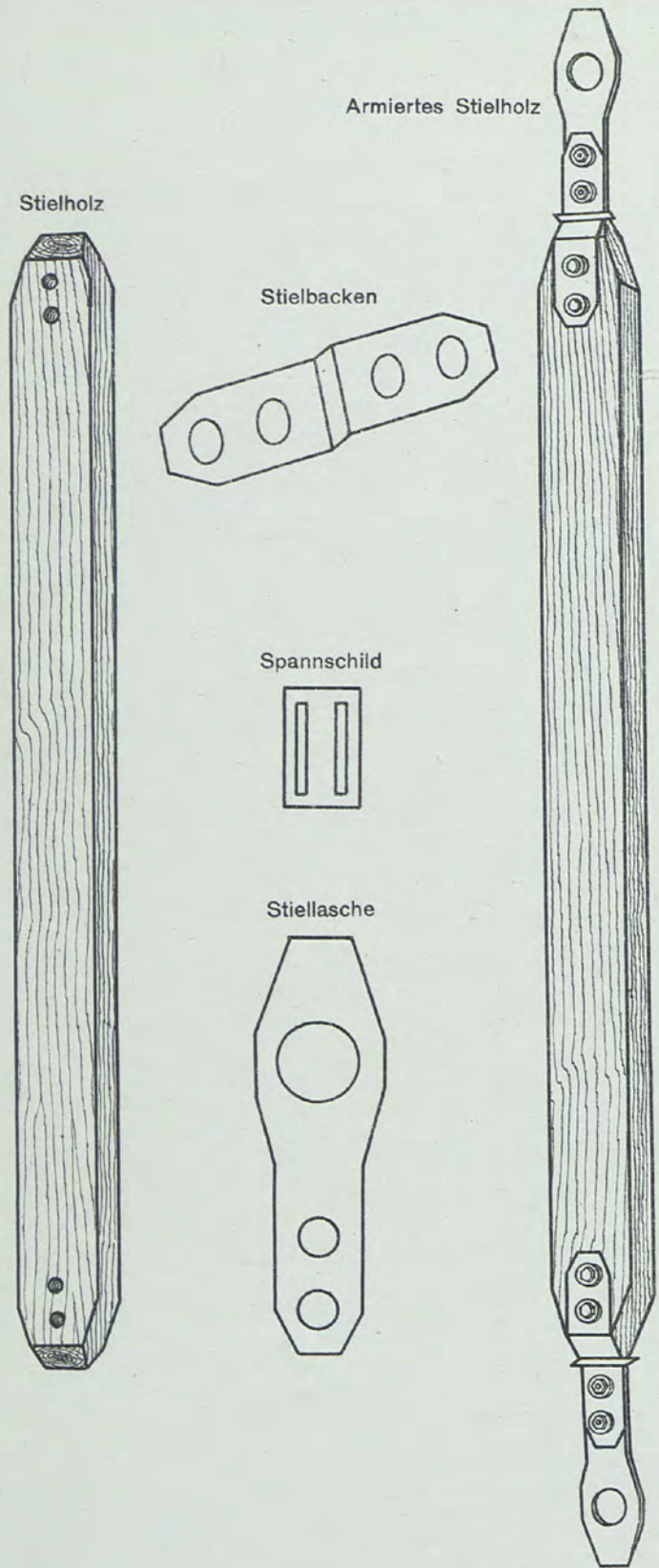

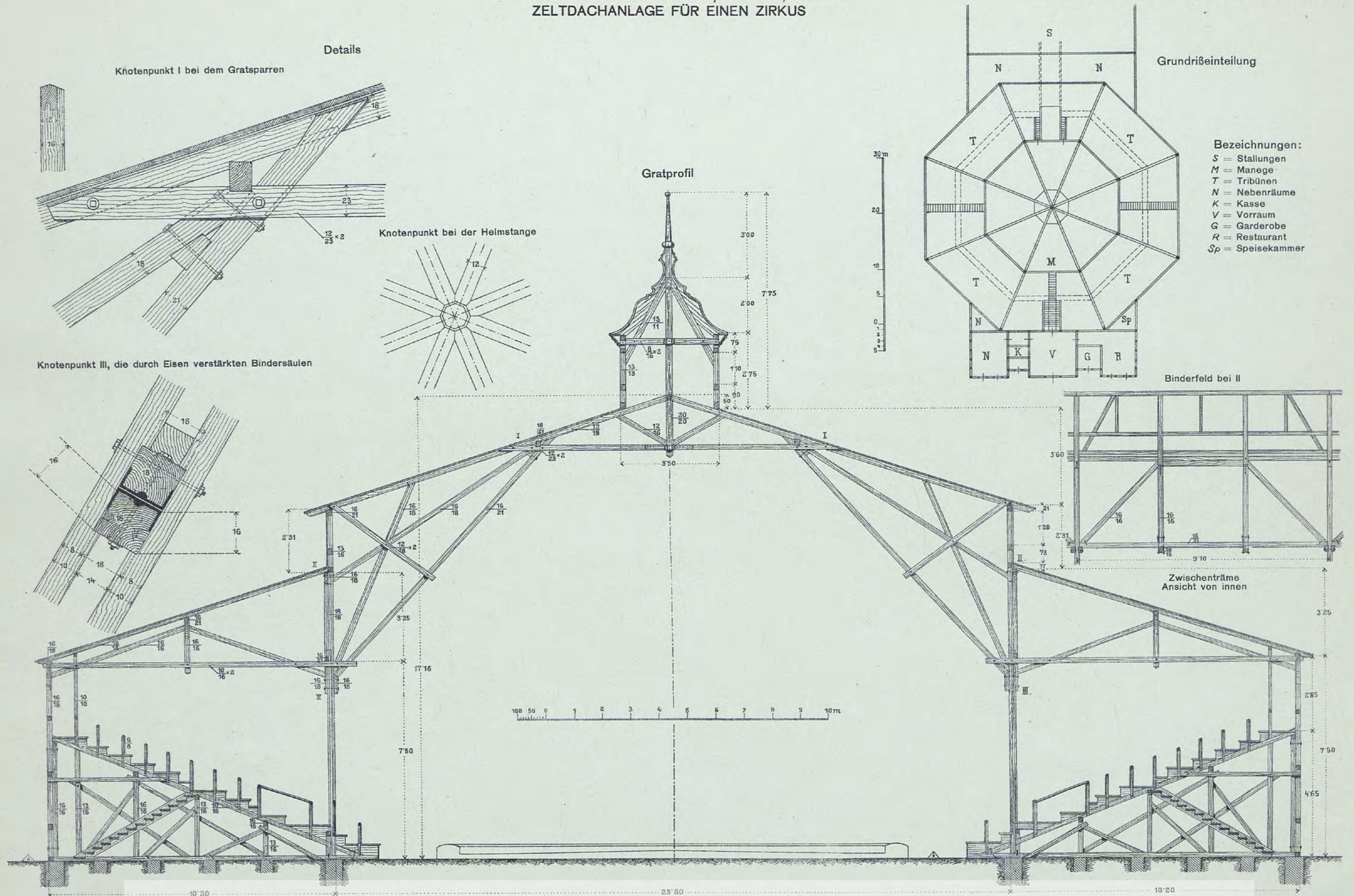

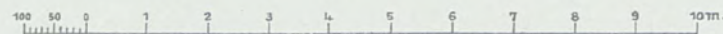
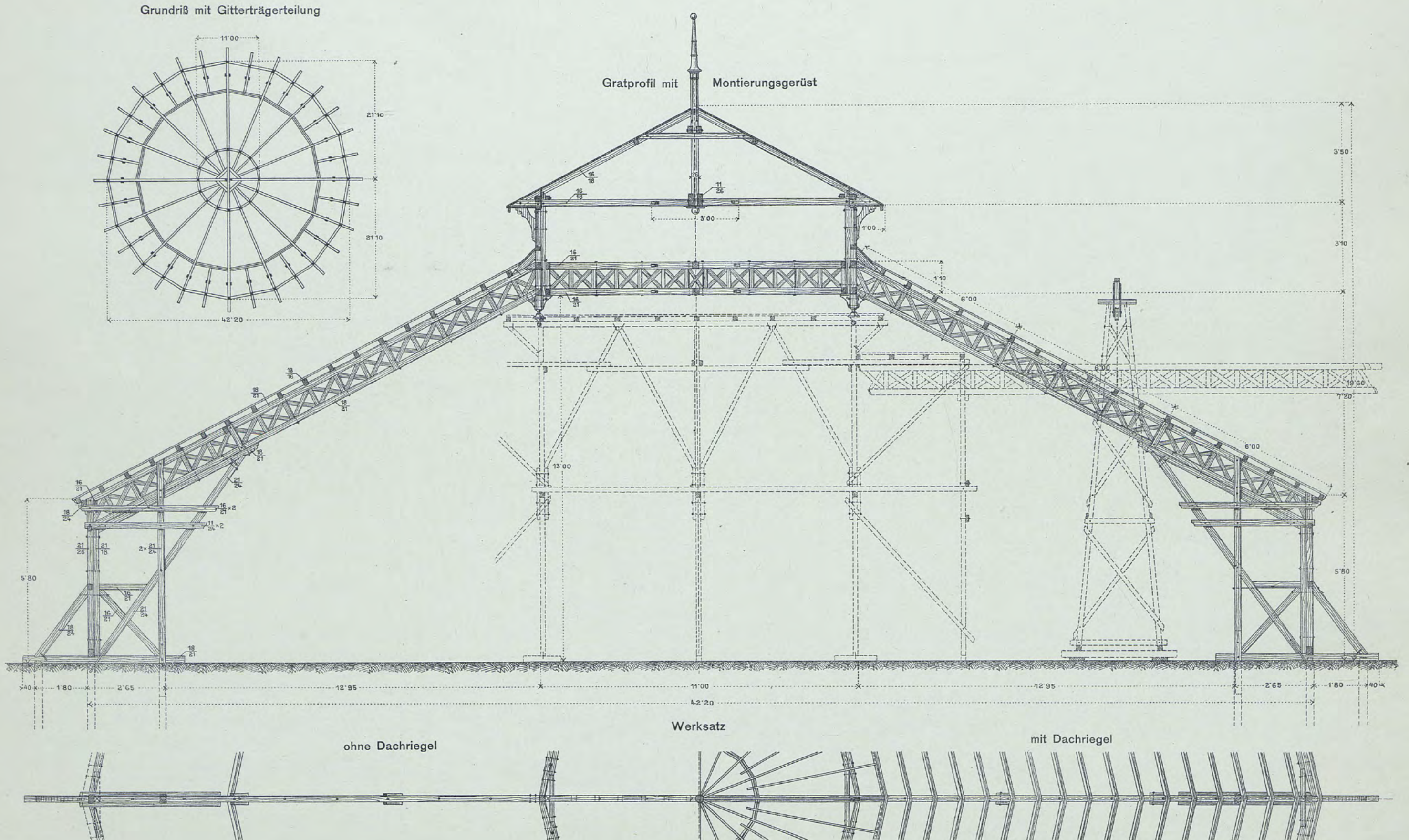

Profil 1 mit durchgehendem Bundtram

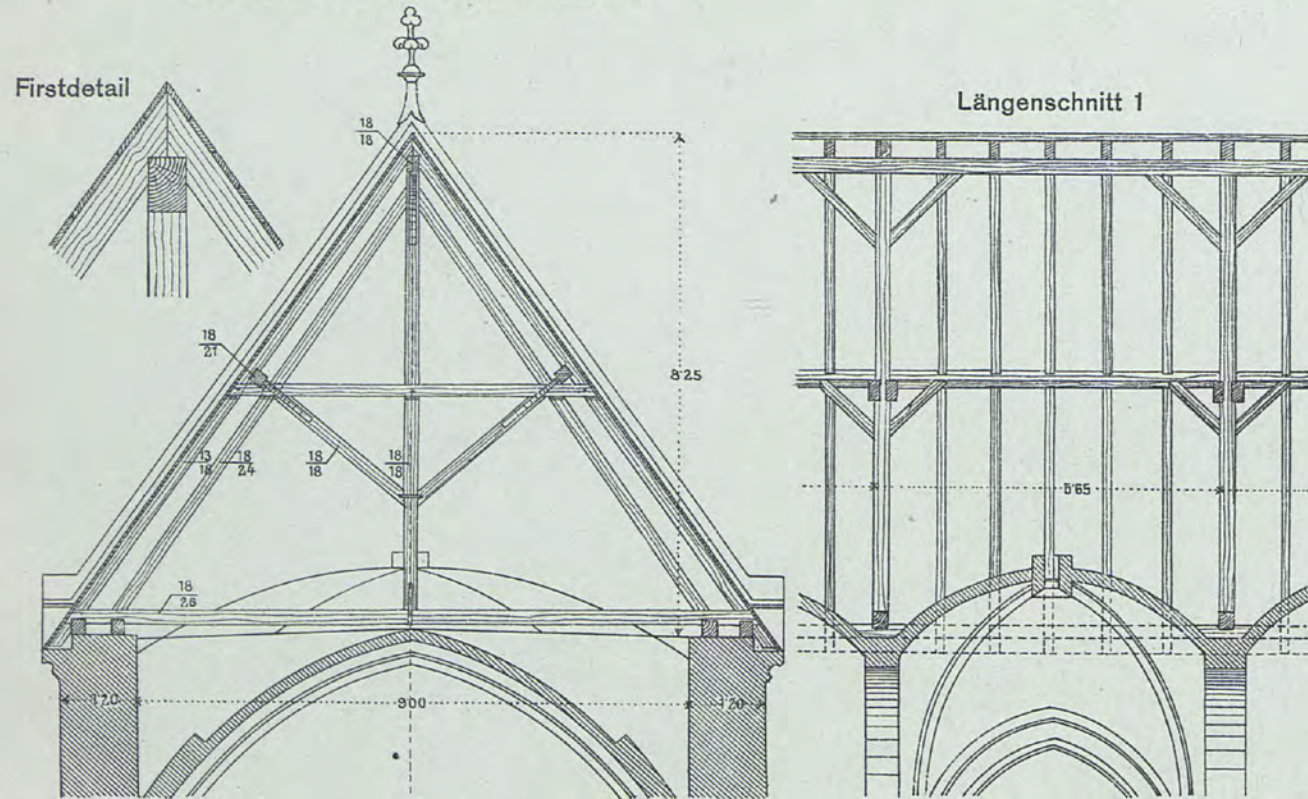

Profil 2 mit Tonnengewölbe ohne Bundtram

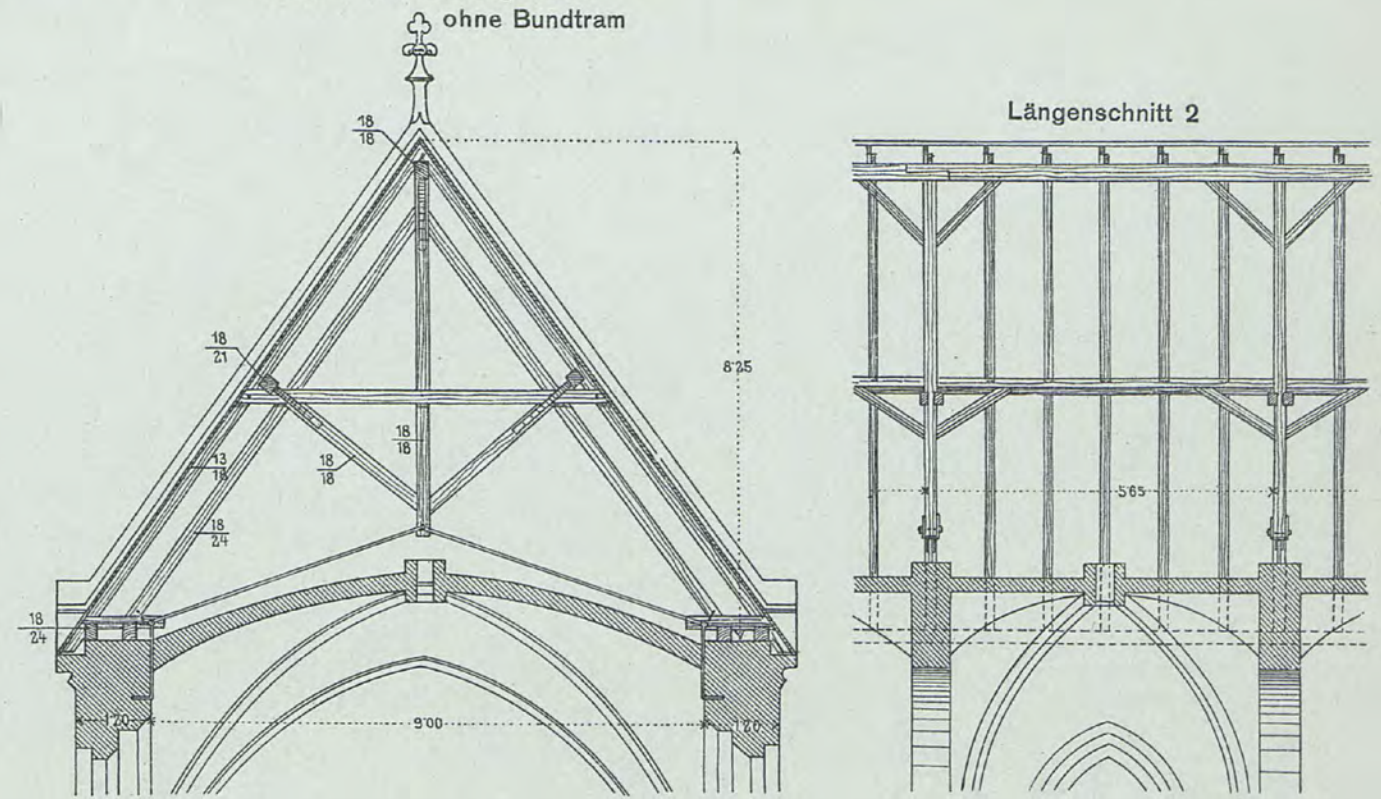

Details

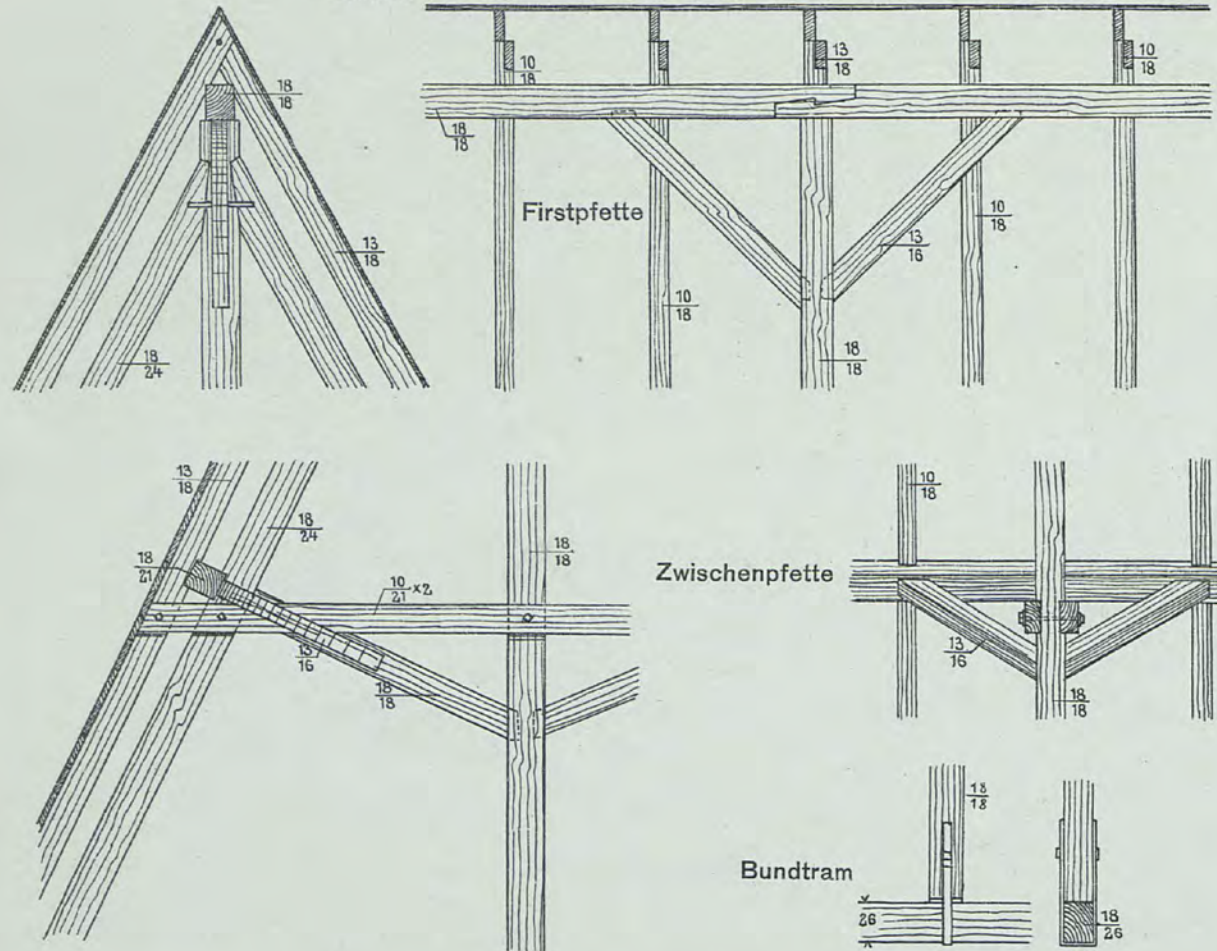

Profil 3

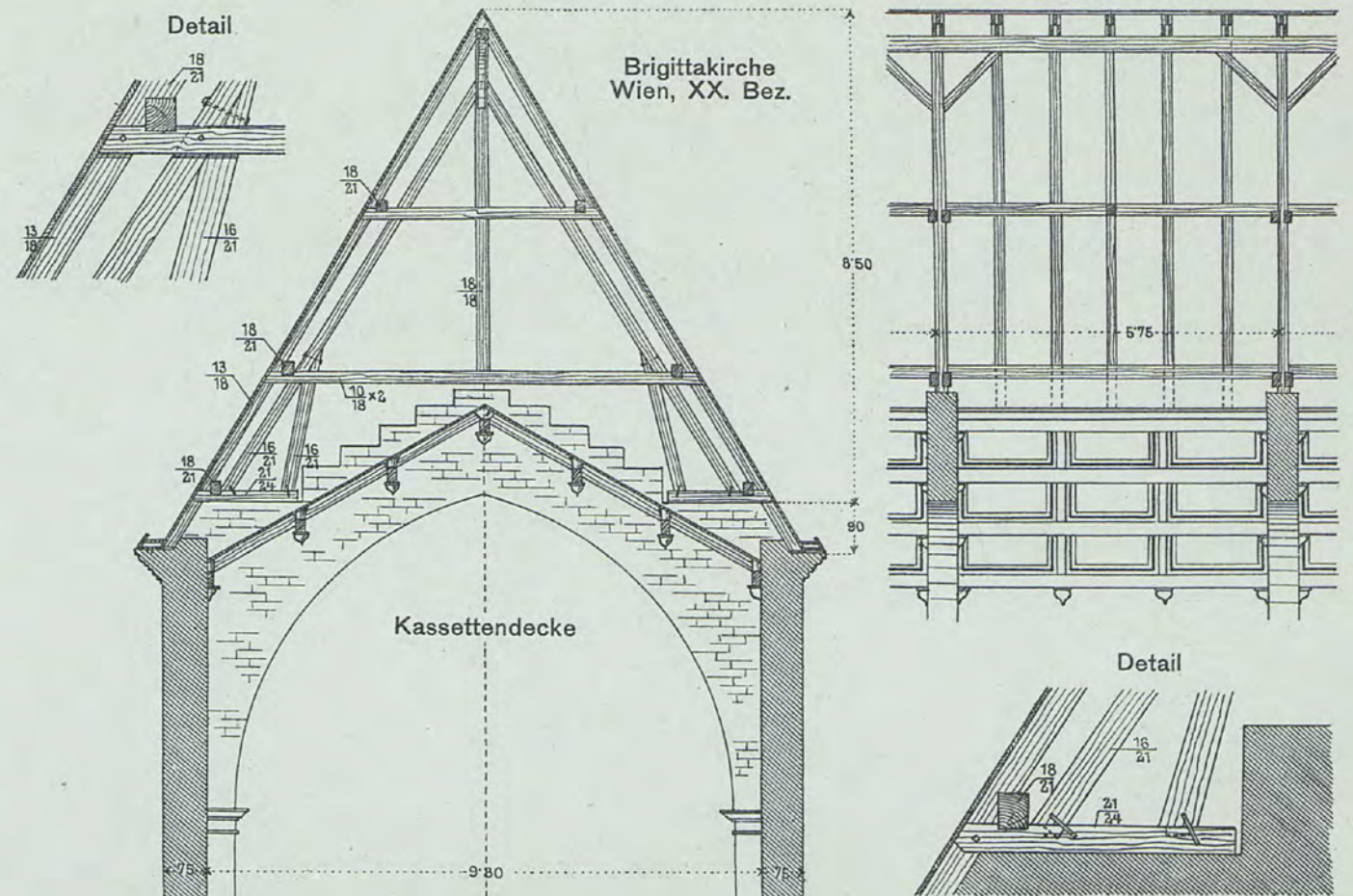

1. Pfarrkirche in Mödling bei Wien,
erbaut 1528, renoviert 1650

Breite 24.0 } 98.4 m²
Binderteilung 4:1 }
Flächeninhalt bei einem Binderfeld
Auf 1 m² Grundfläche entfällt 0.459 m³ Kantholz

Profil 1

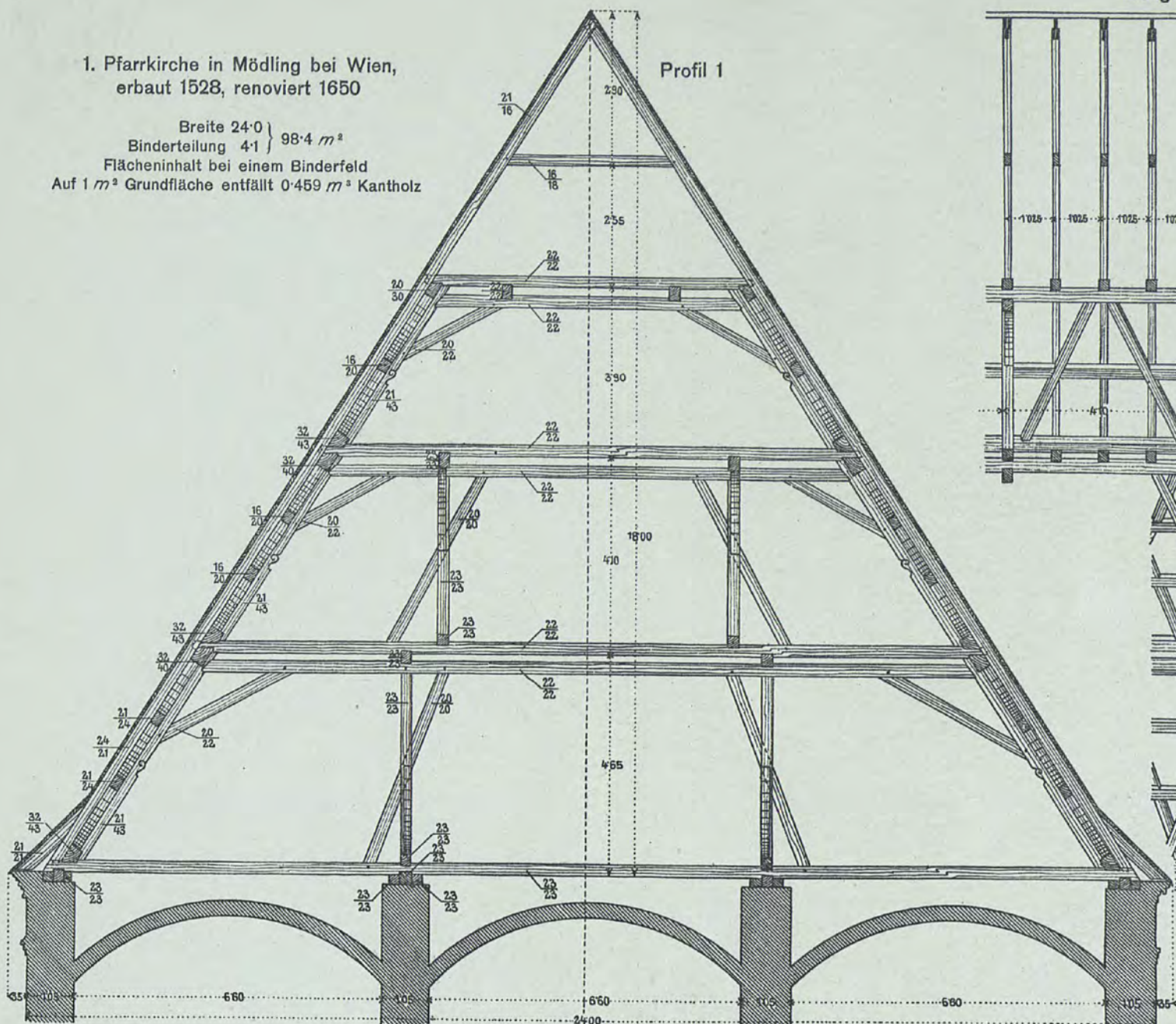

Längenschnitt 1

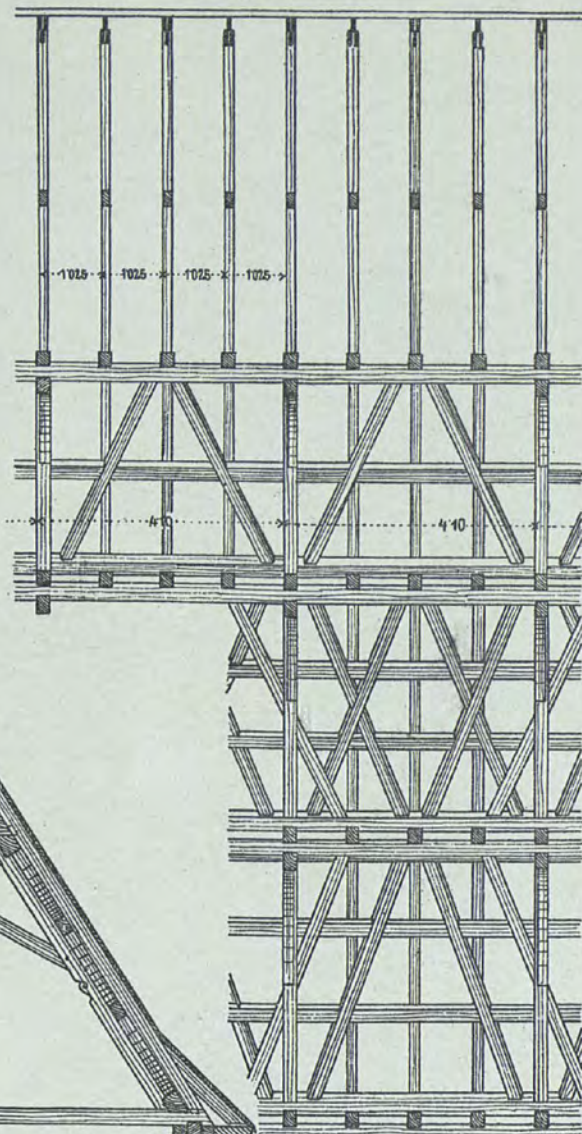

2. Pfarrkirche in Wien XXI (Floridsdorf),
erbaut 1907

Breite 25.5 } 94.35 m²
Binderteilung 3:7 }
Flächeninhalt bei einem Binderfeld
Auf 1 m² Grundfläche entfällt 0.187 m³ Kantholz

Profil 2

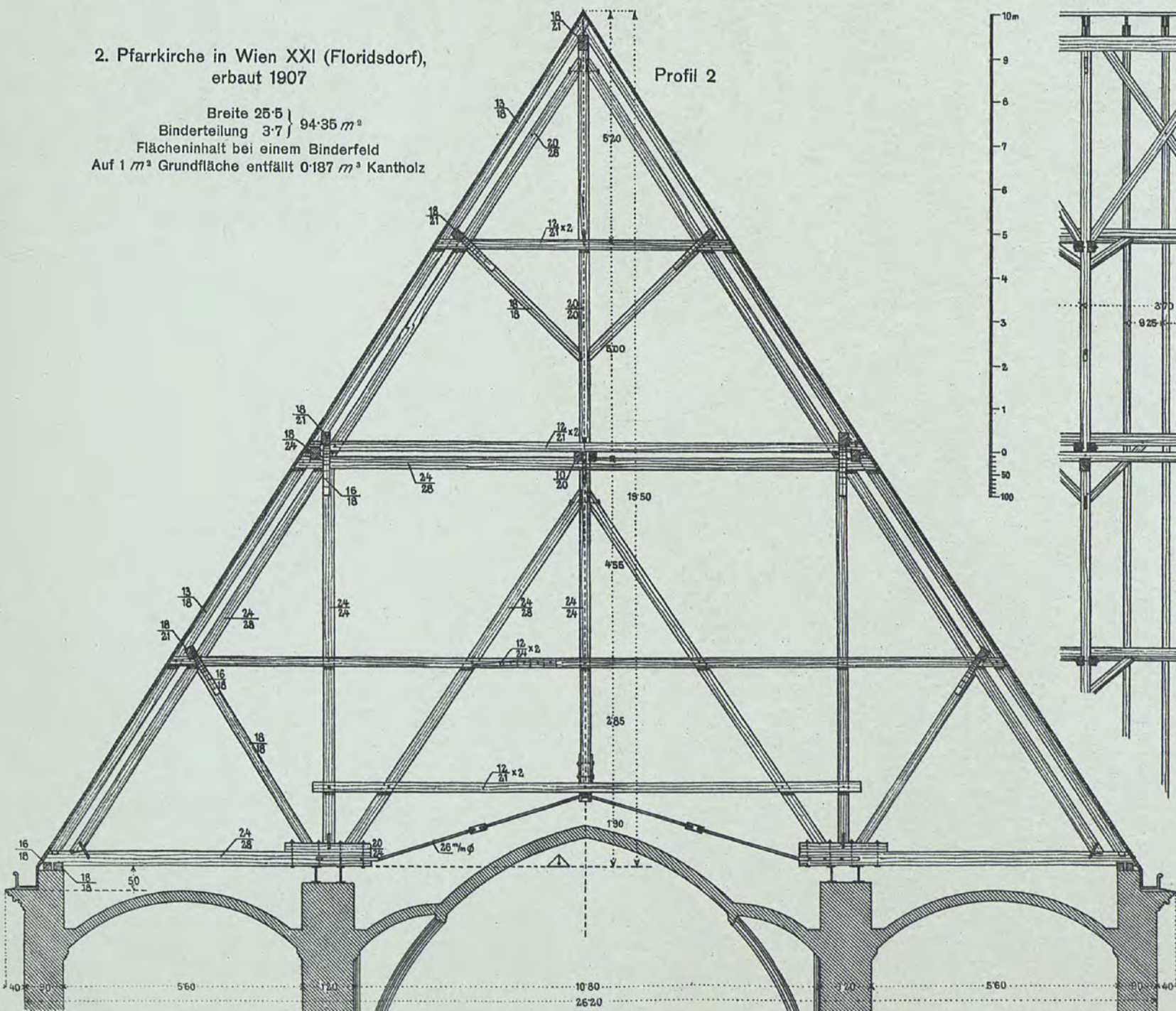

Längenschnitt 2

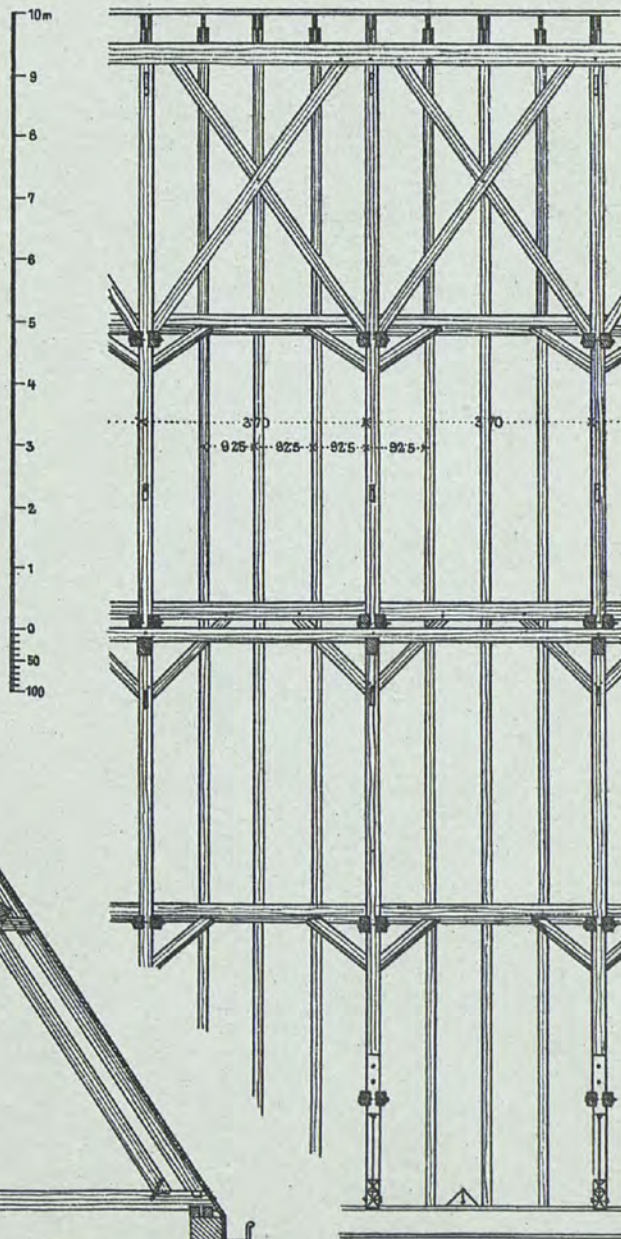

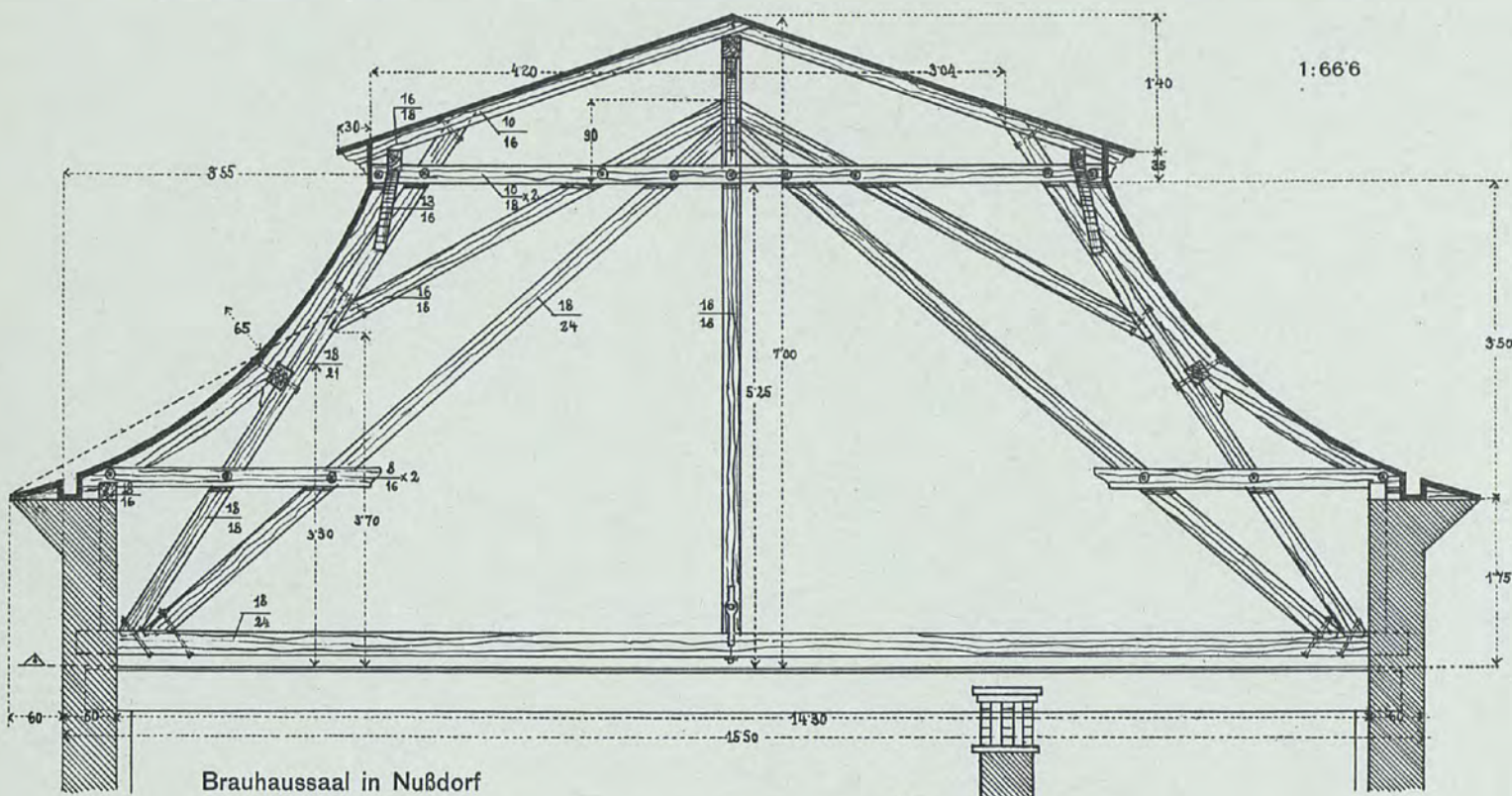
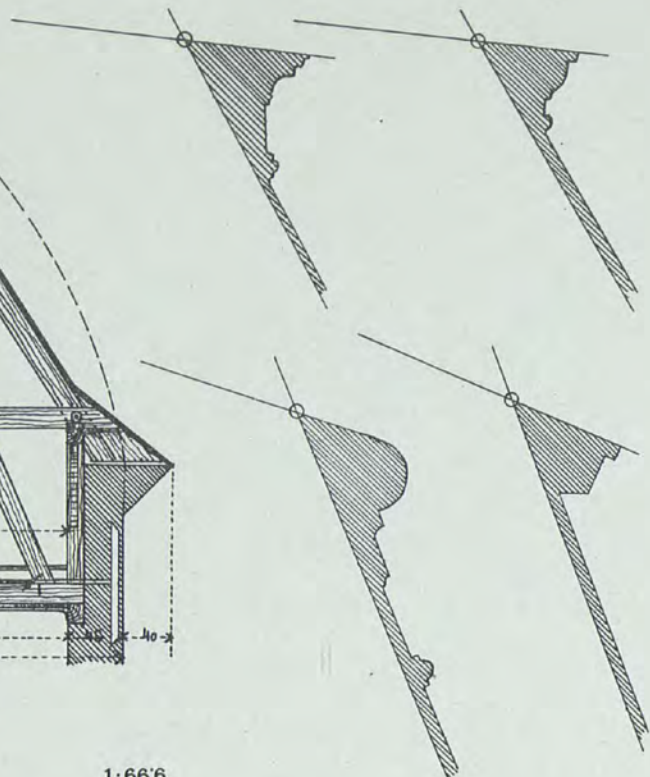
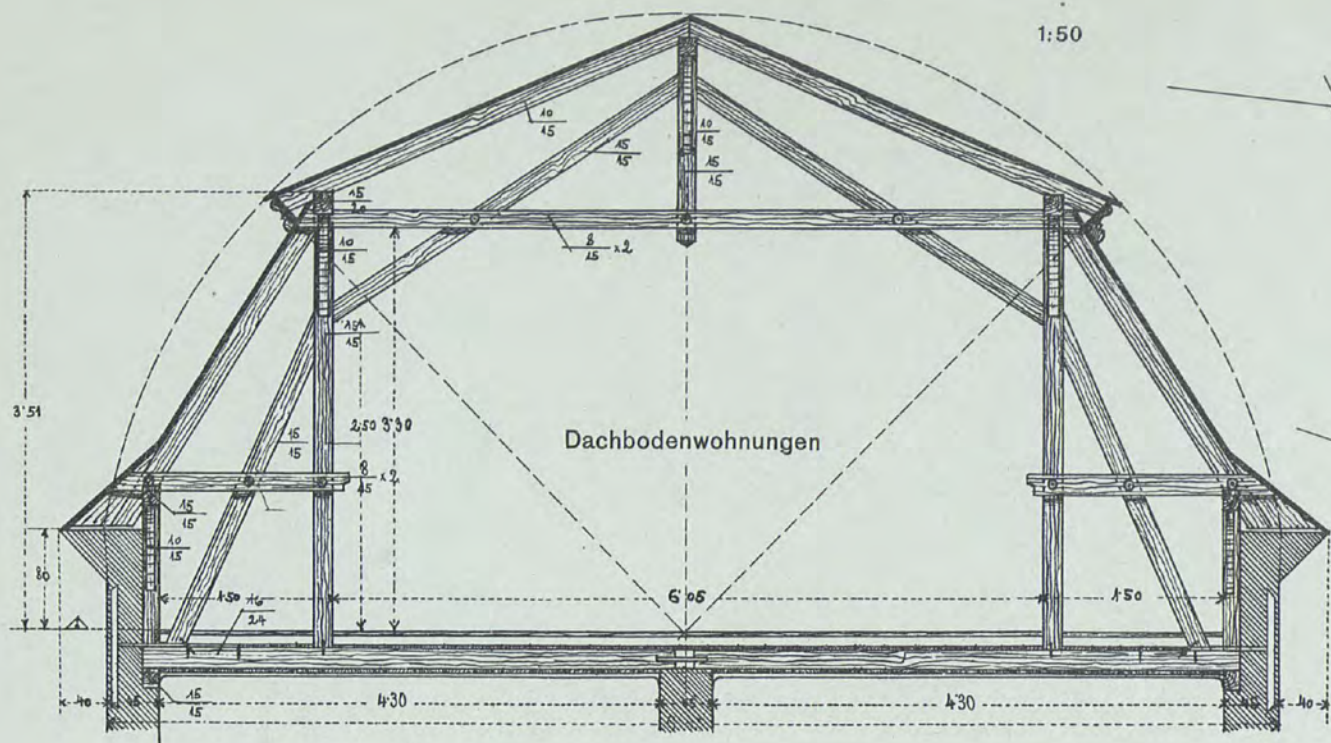

Mansardegesimse

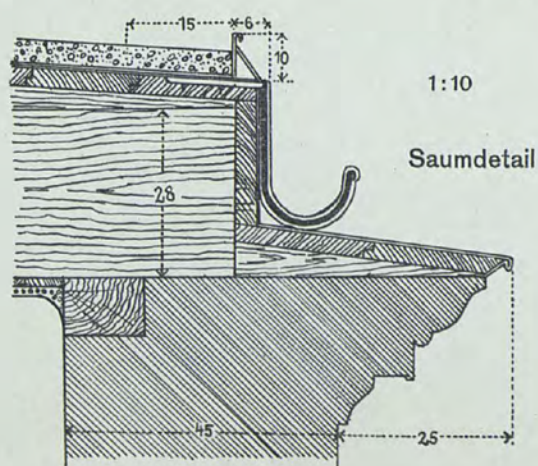
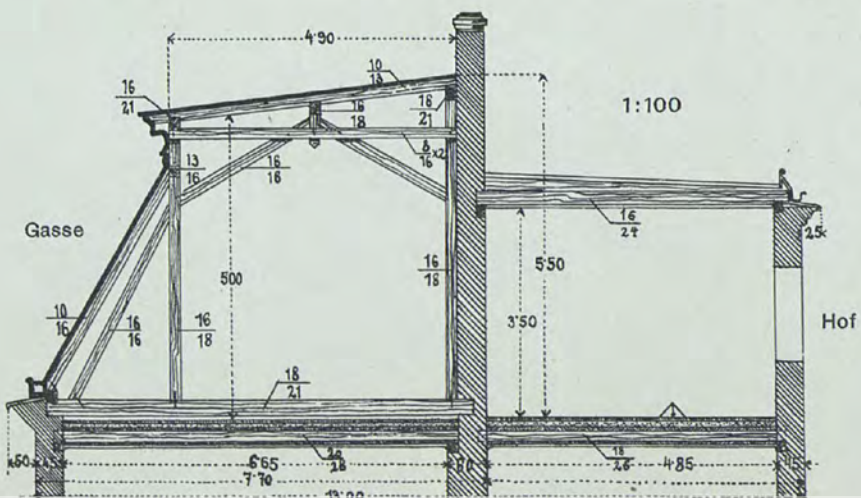
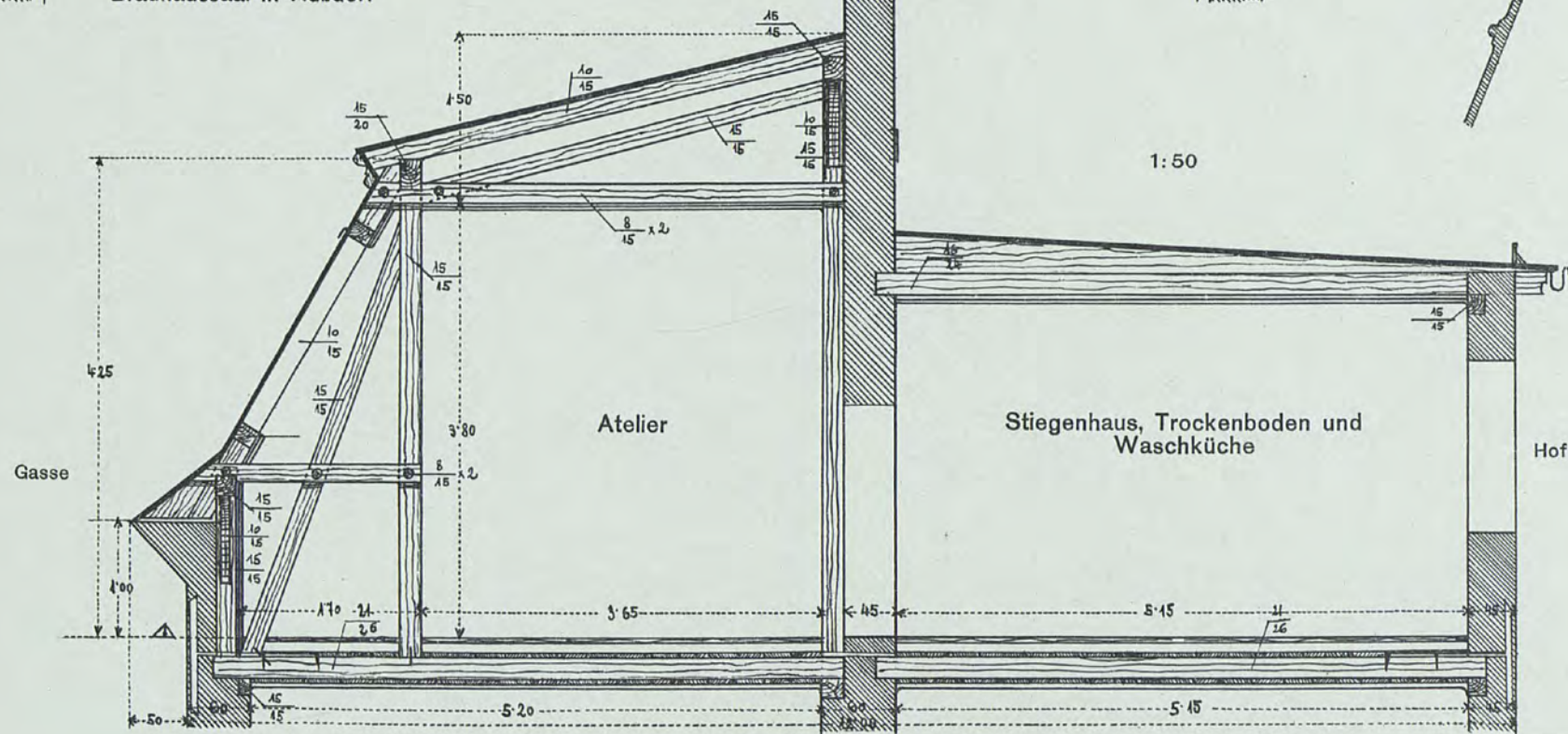
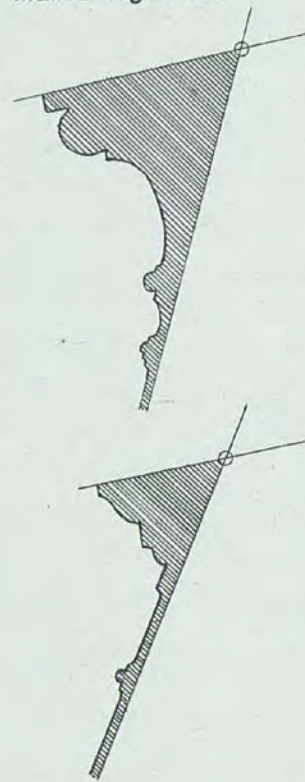

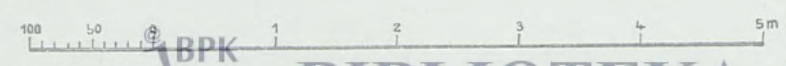
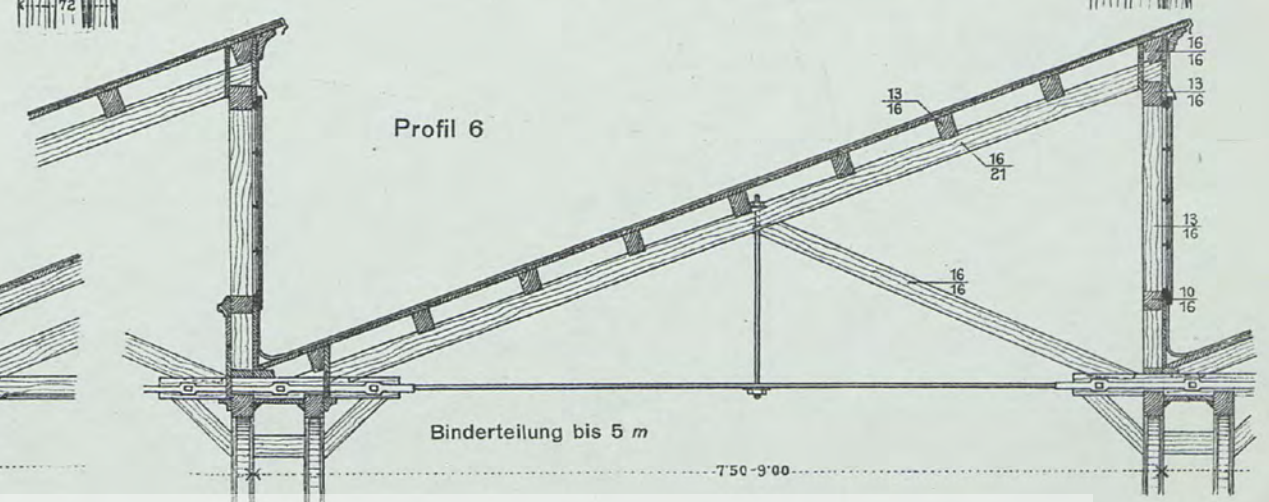
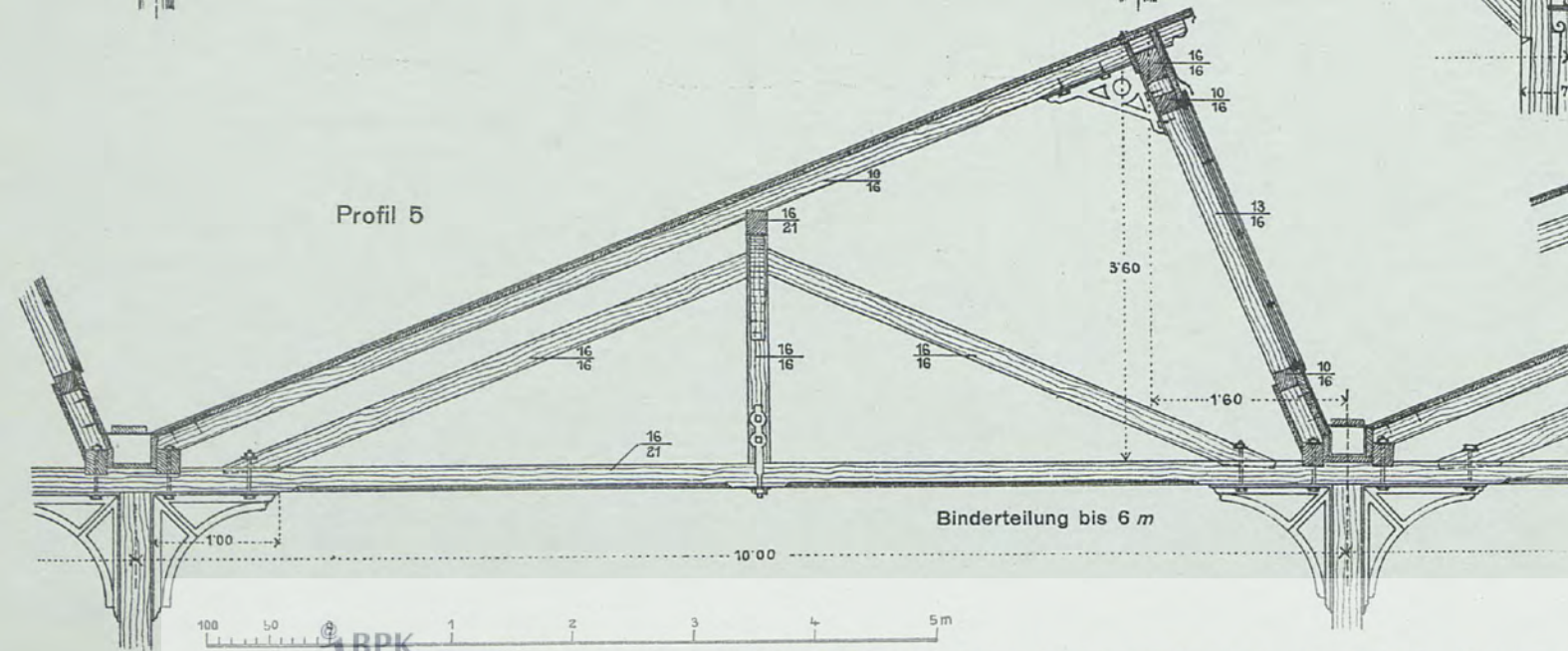
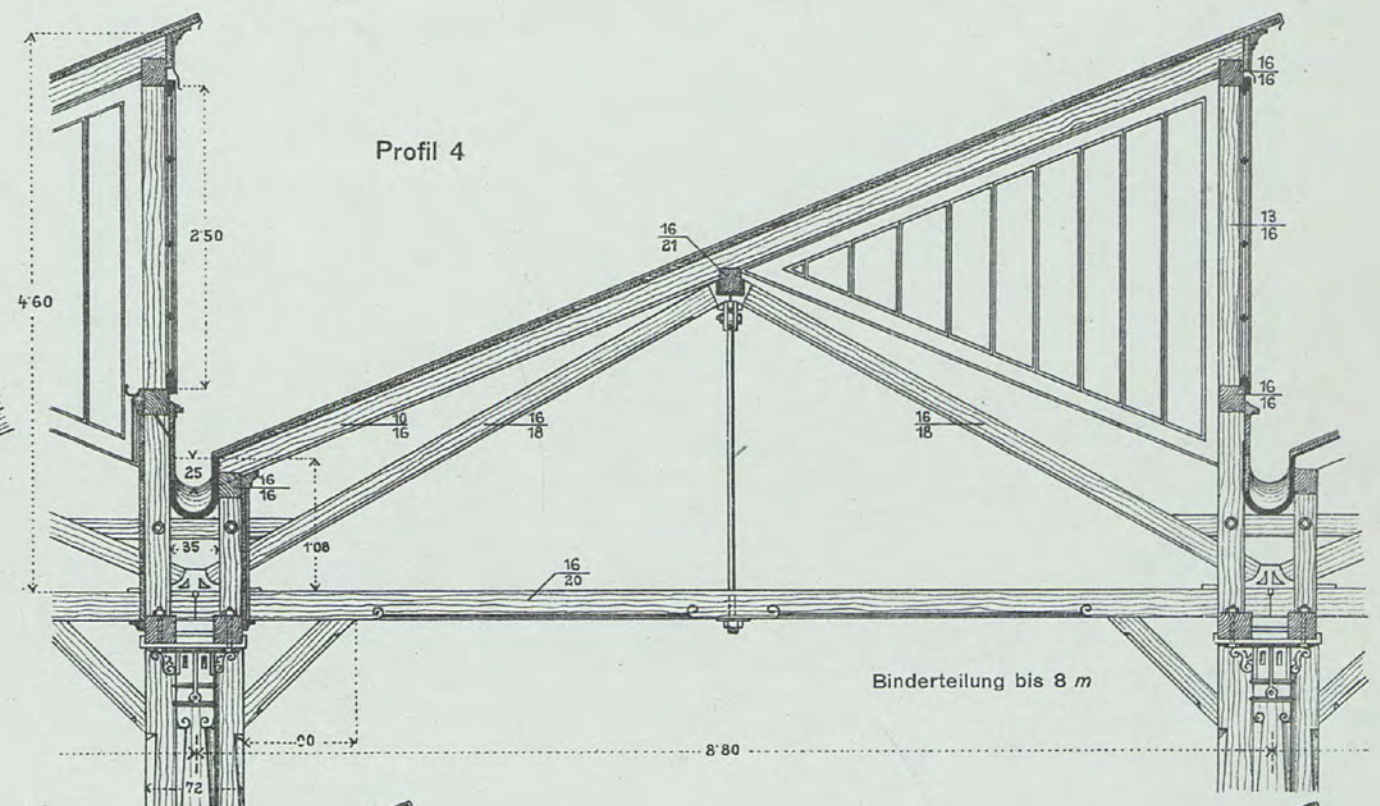
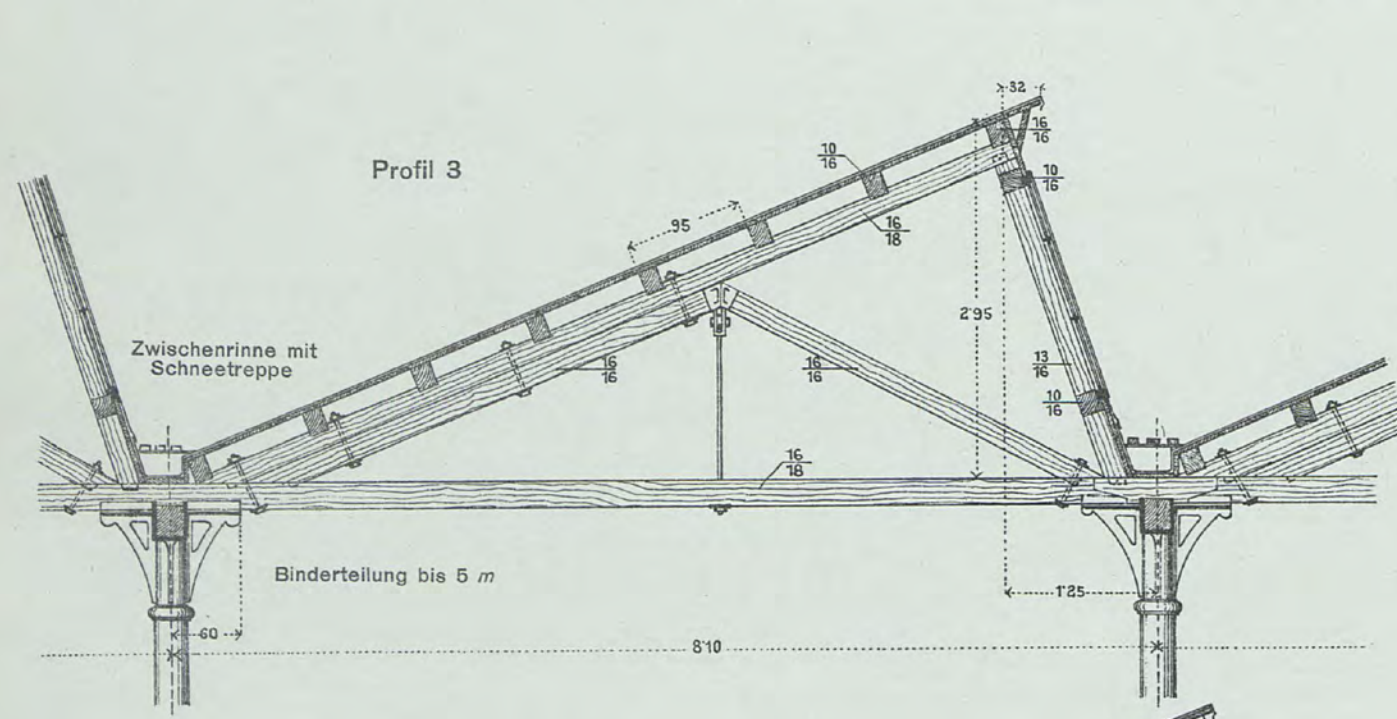
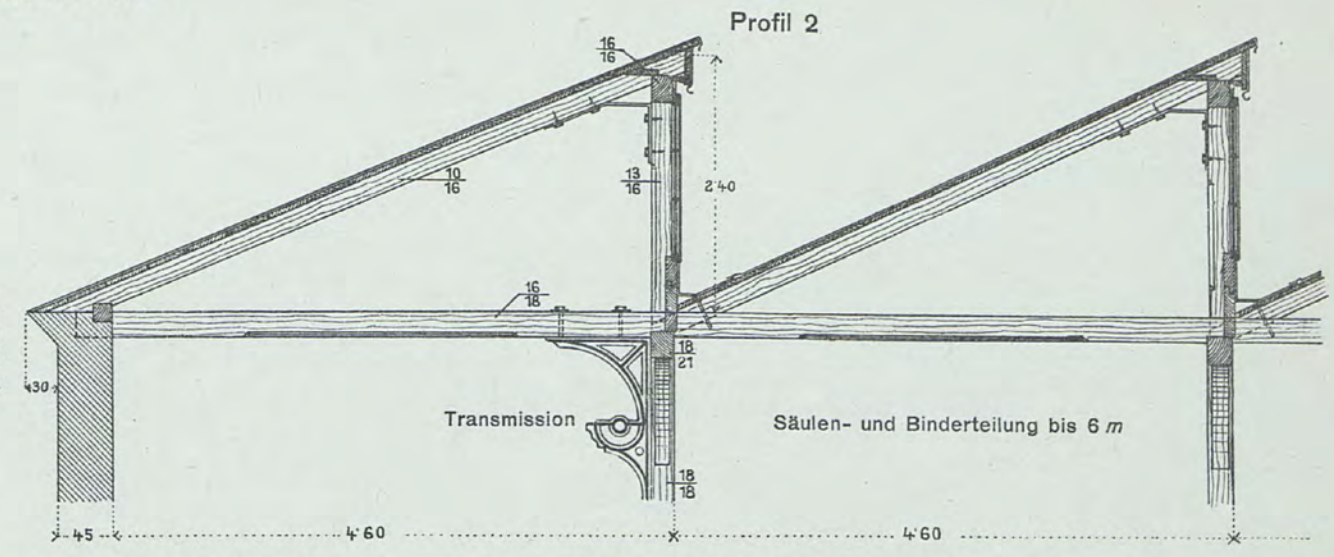
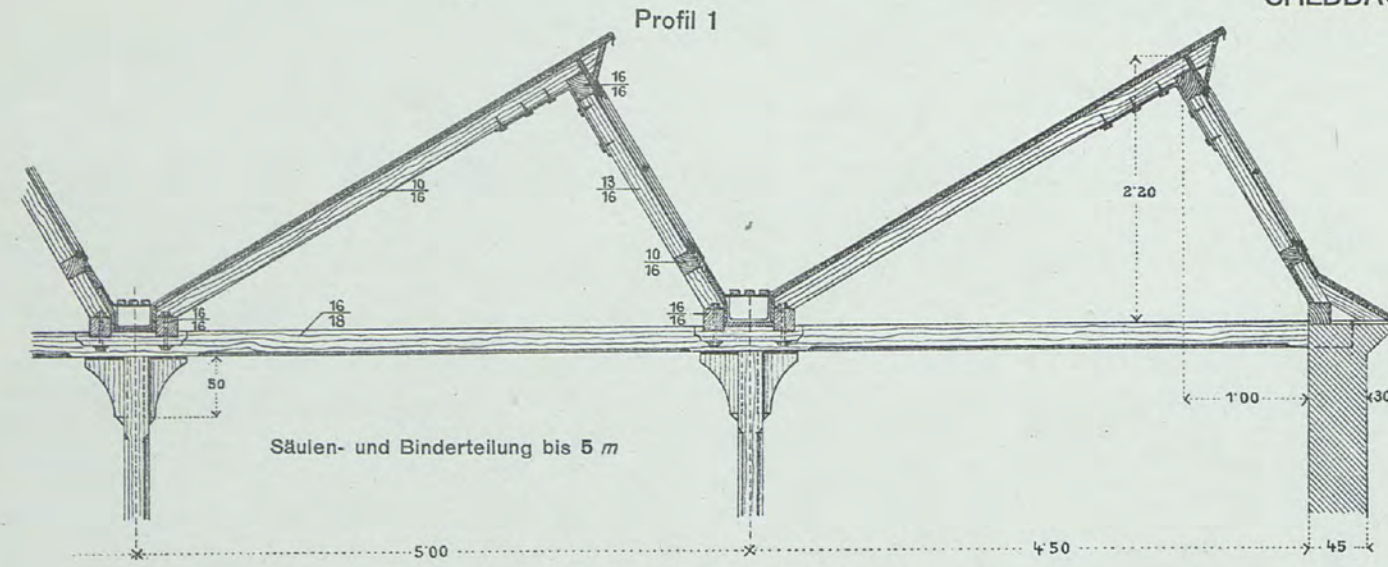

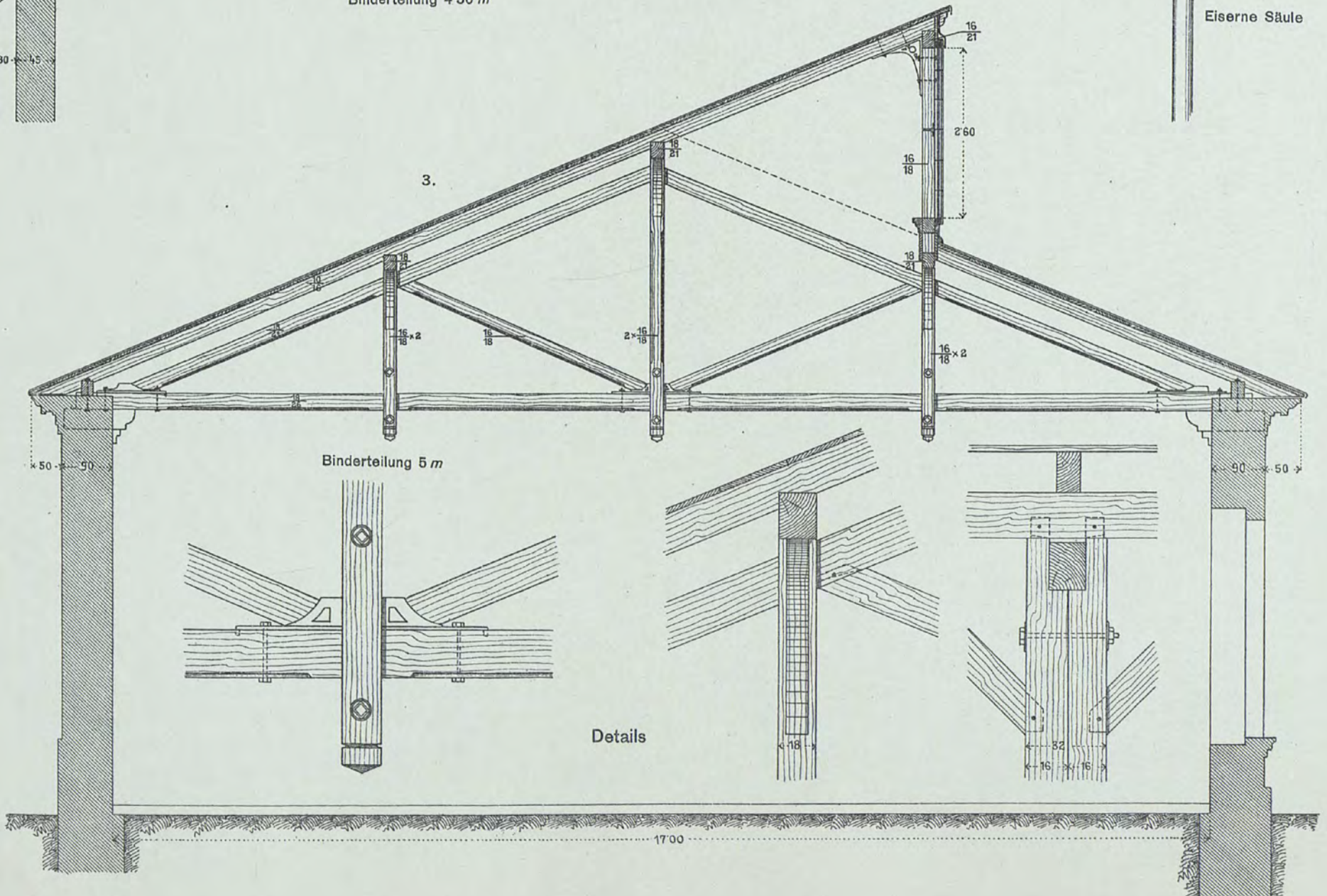
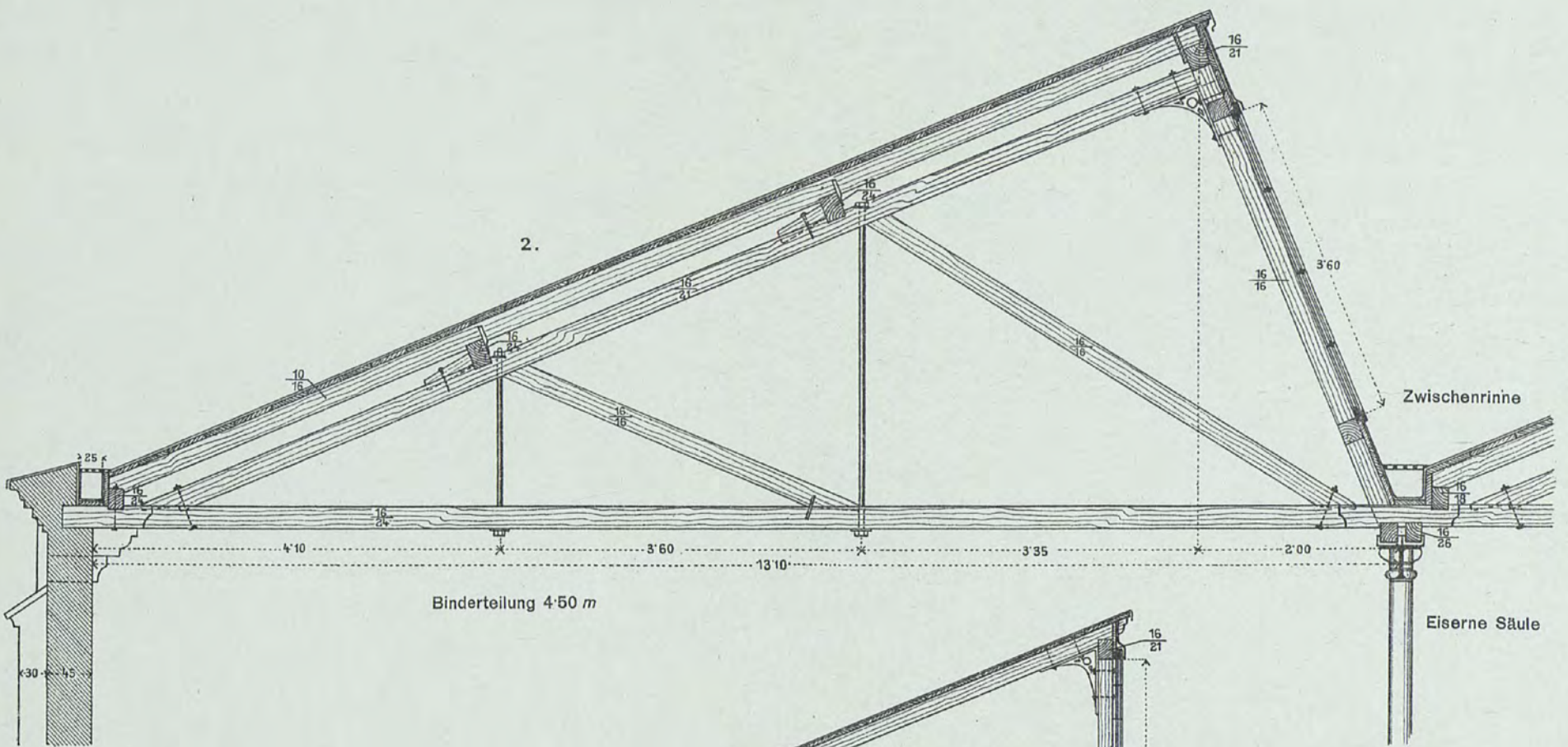
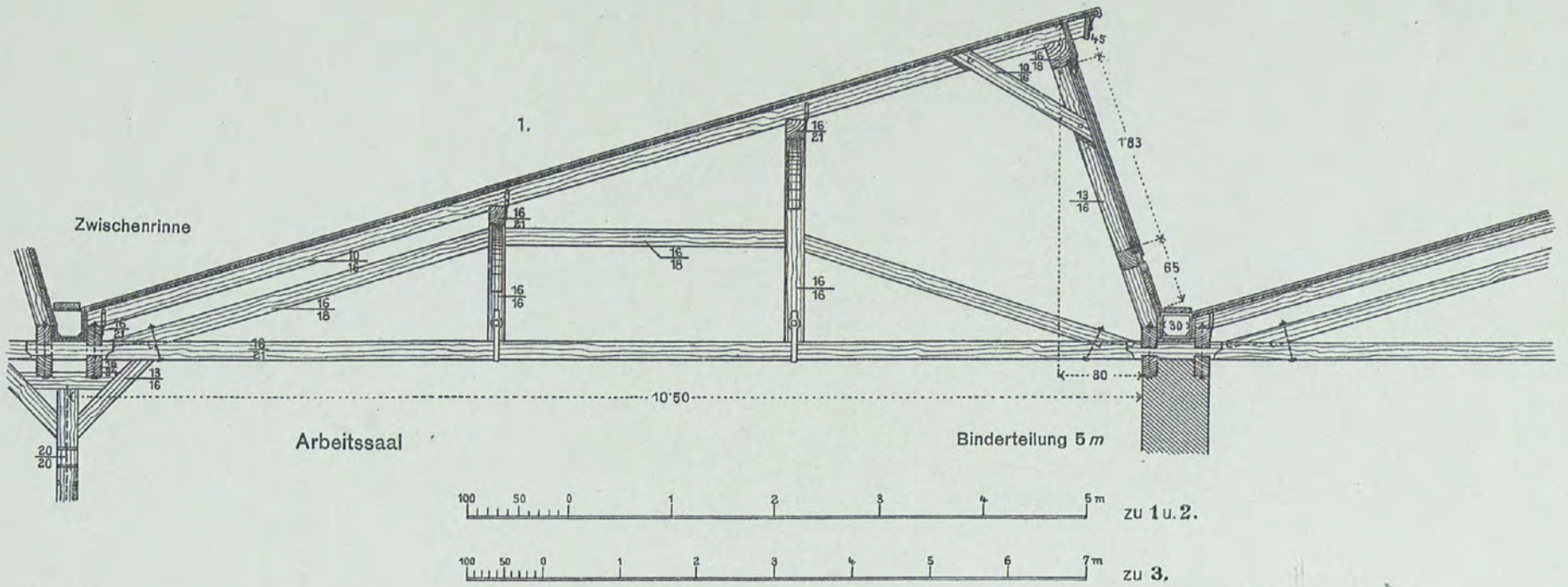

DER ZIMMERER-MEISTER, I. TEIL, Nr.85
SHEDDACHPROFILE

DER ZIMMERER-MEISTER, I. TEIL, Nr. 87
DÄCHER FÜR HOLZZEMENTDECKUNG

Professor und Stadtzimmerer-Meister A. BAUDOIN, Wien

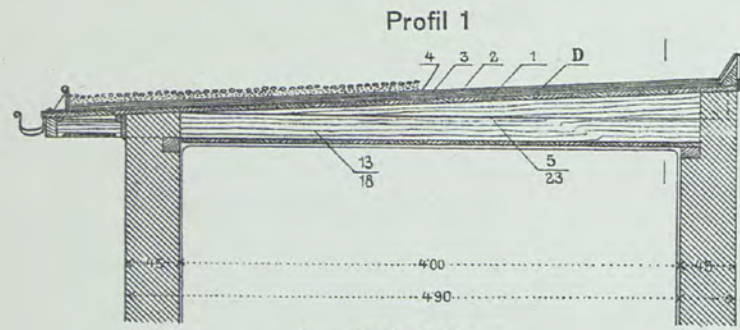

D = Dachschalung
1, 2, 3, 4 = Papierlagen mit Holzzement
Sch = Feiner und grober Schotter

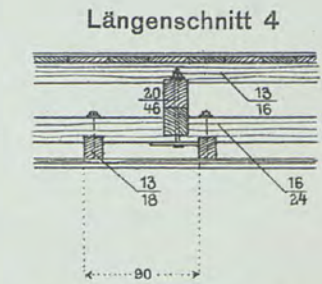
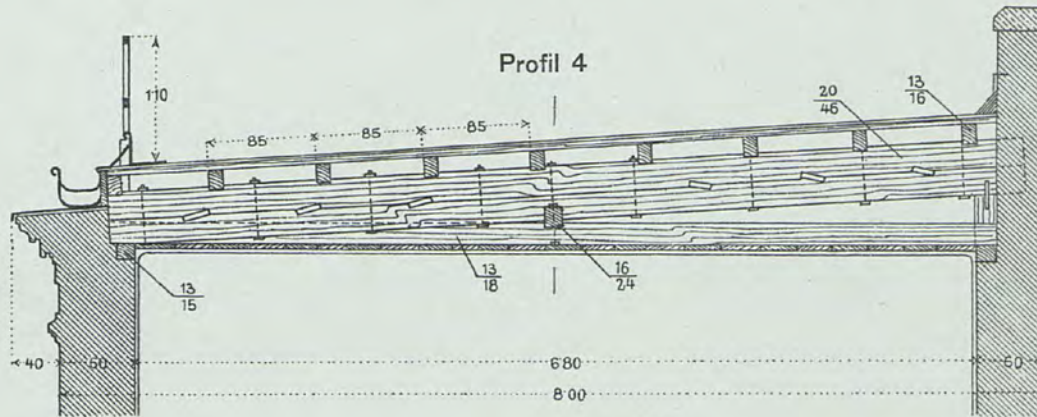
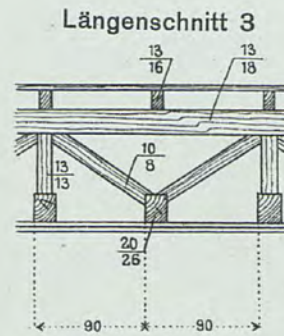
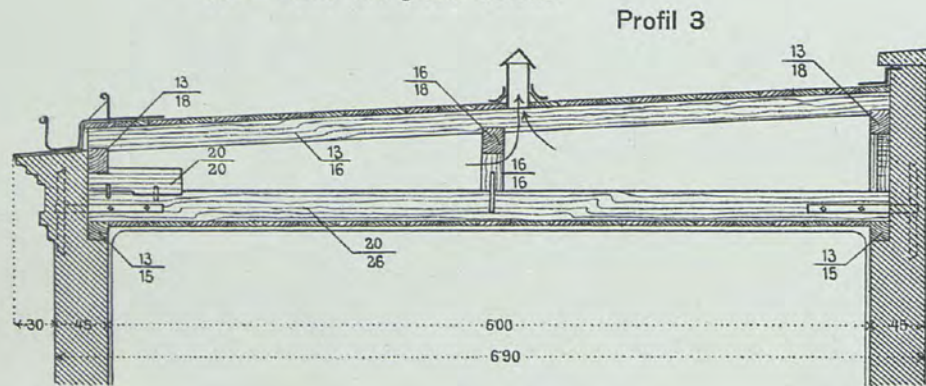
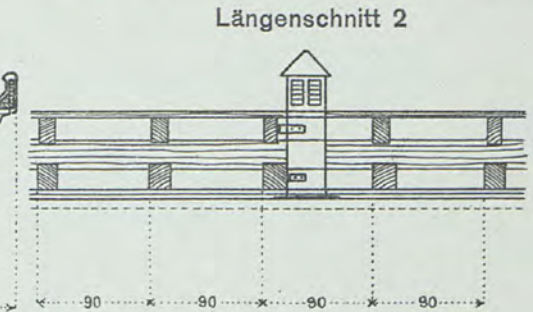
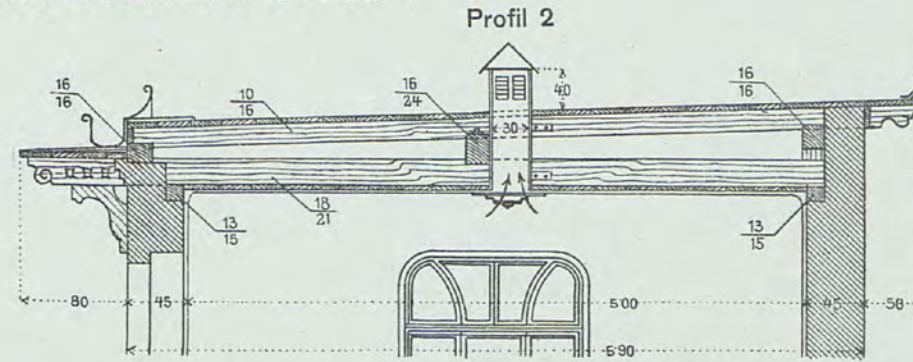
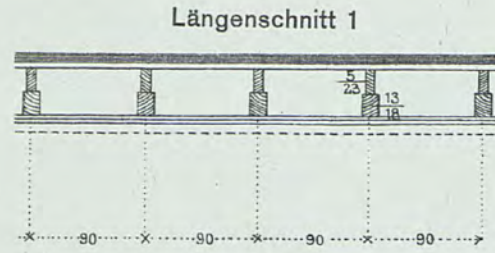

Teilung der Träger = 3 m

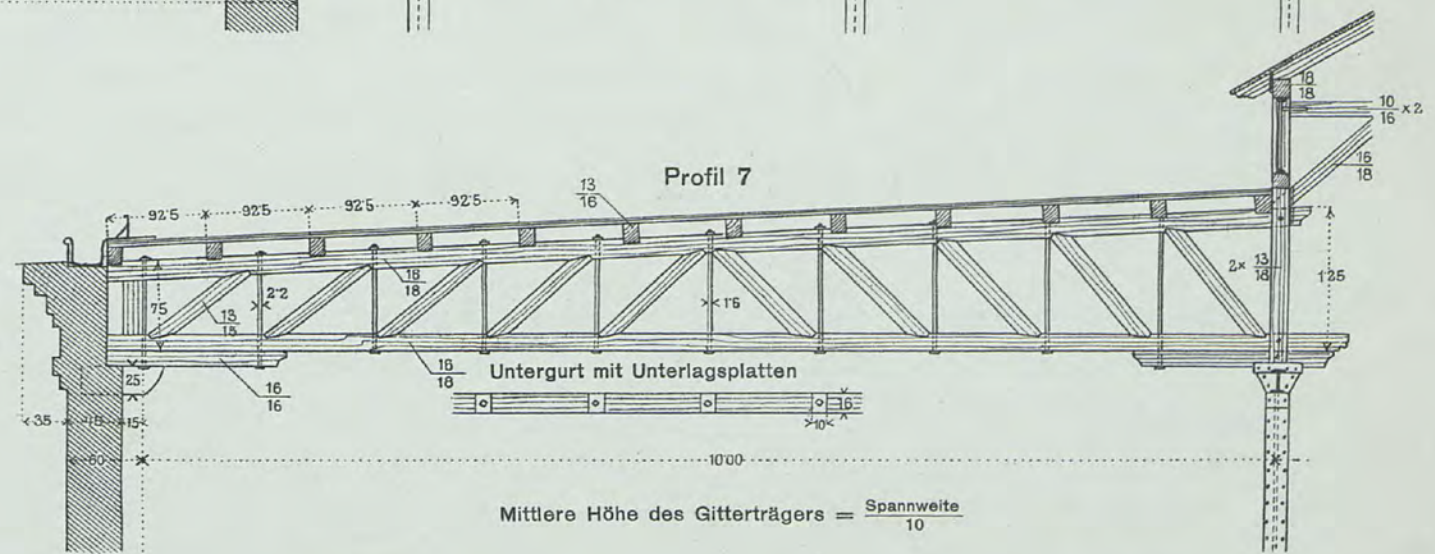
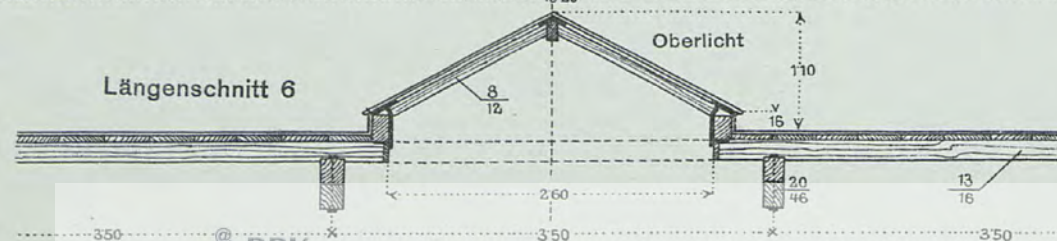
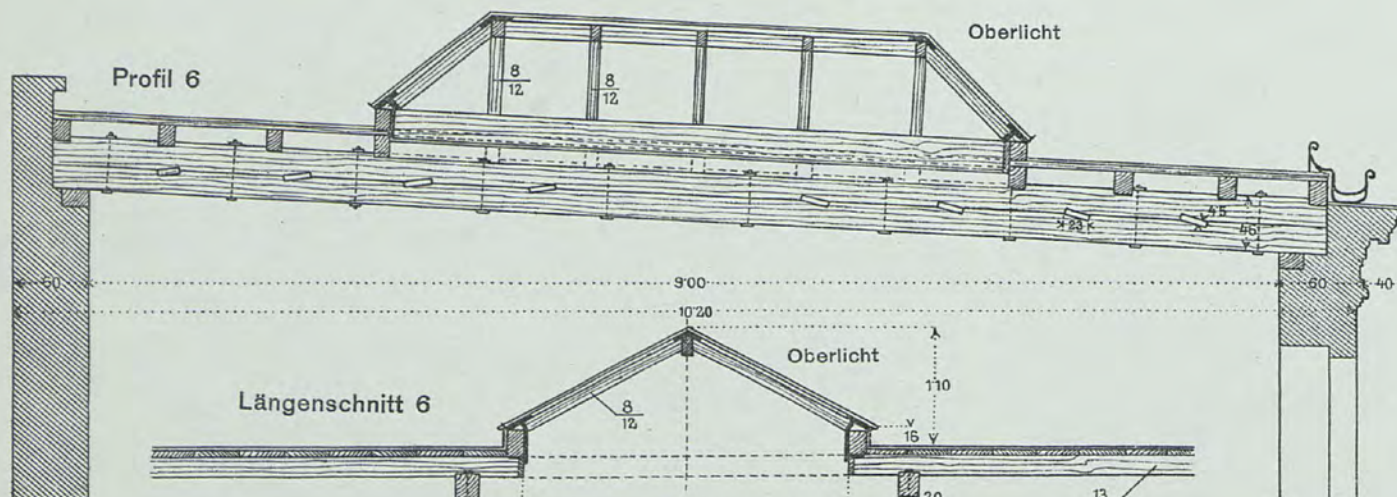
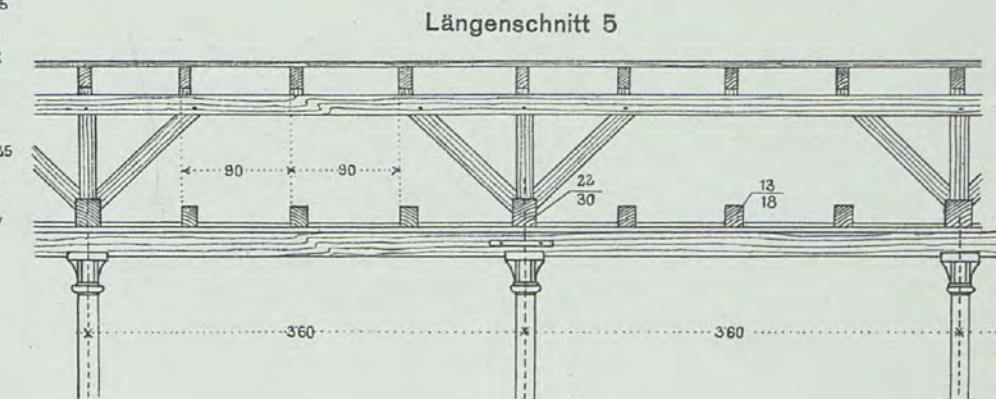
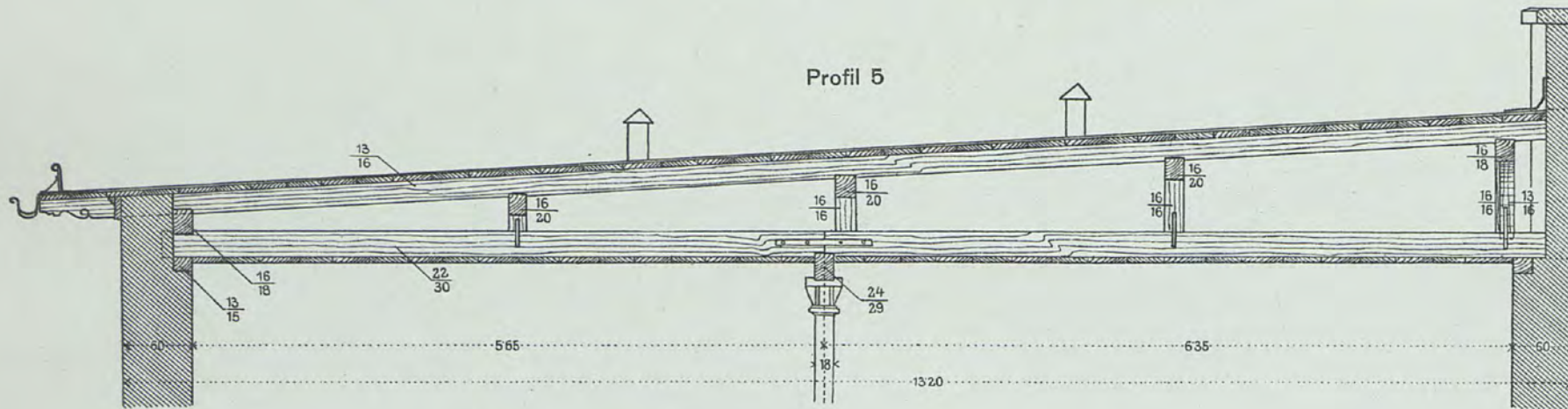

Mittlere Höhe des Gitterträgers = $\frac{\text{Spannweite}}{10}$



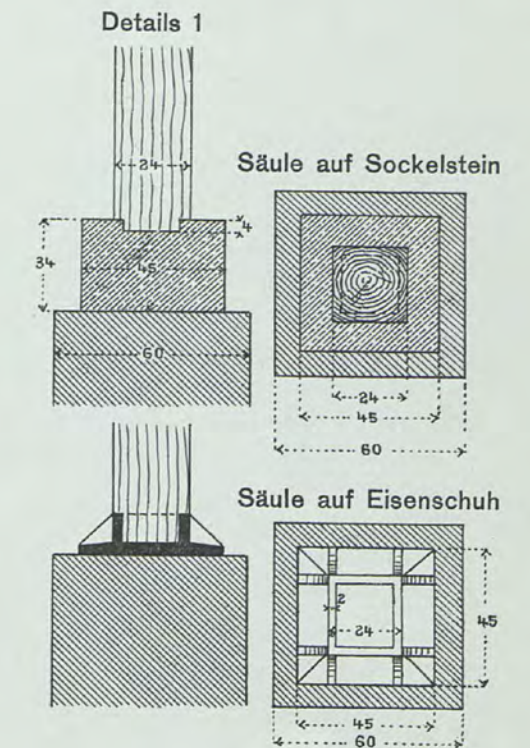
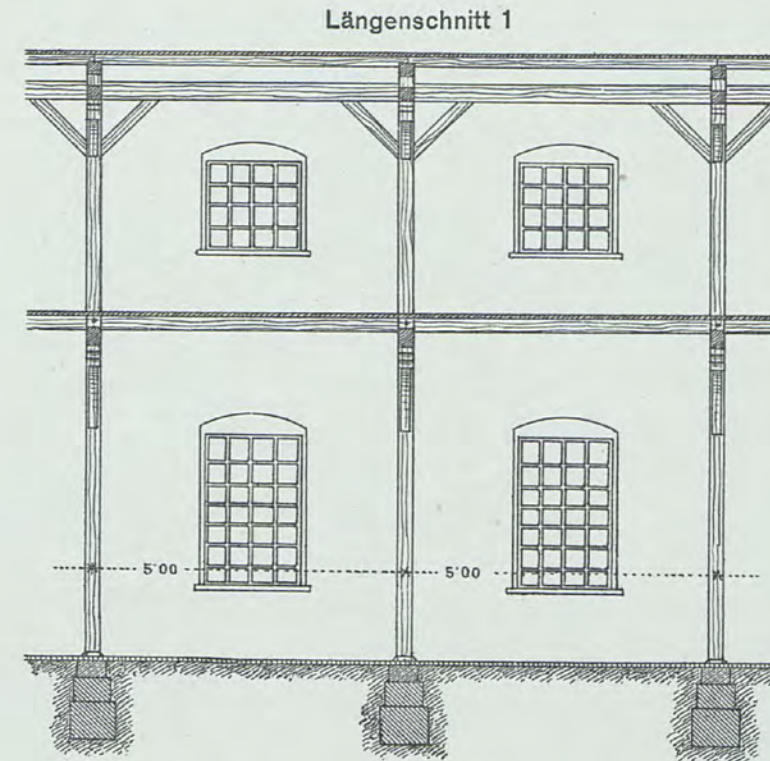
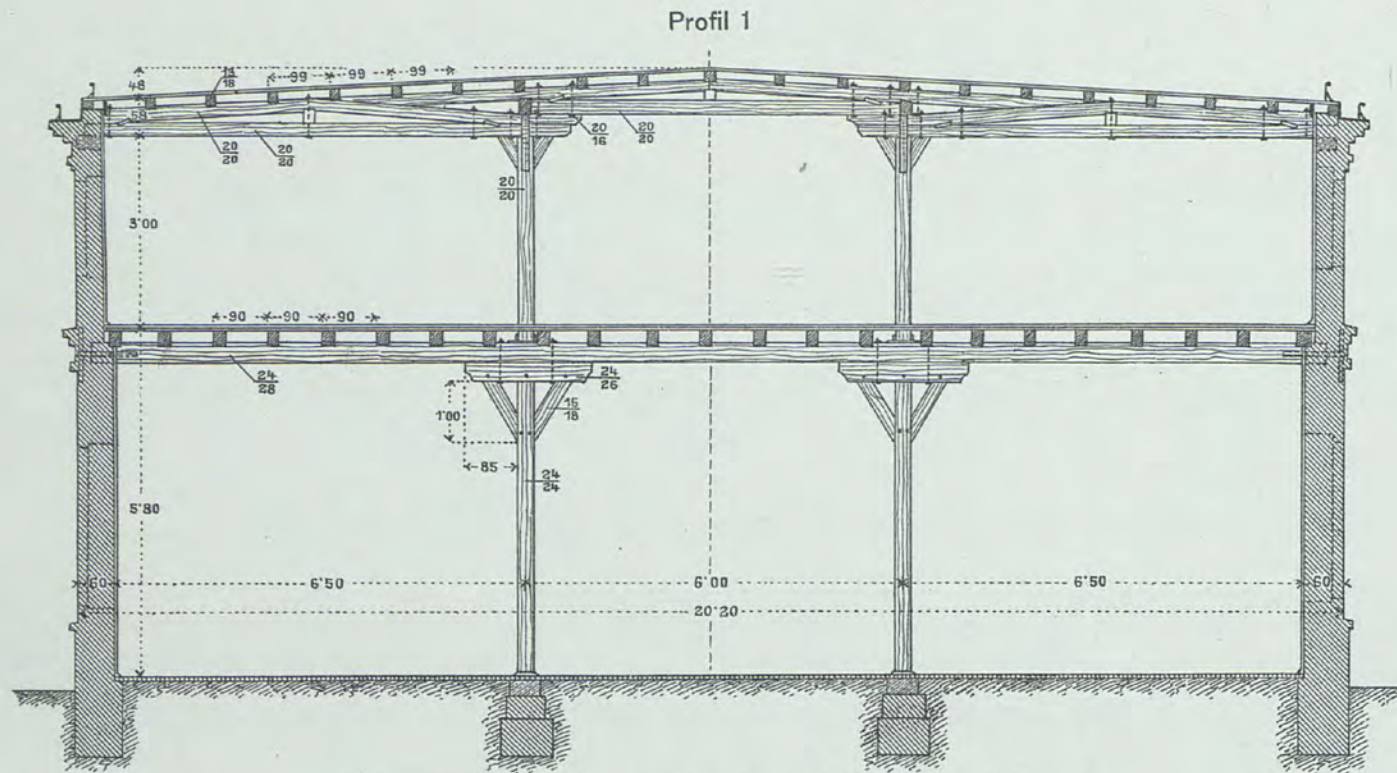

Die feuerbeständige Holzkonstruktion wird durch Verkleidung mit Zementputz auf Latten „feuersicher“ ausgebildet

Säulenverkleidung

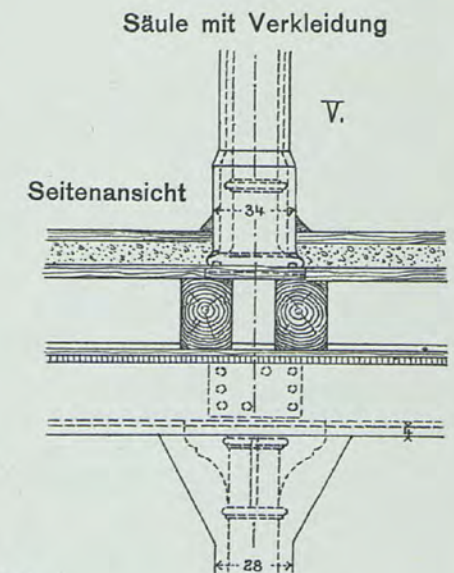
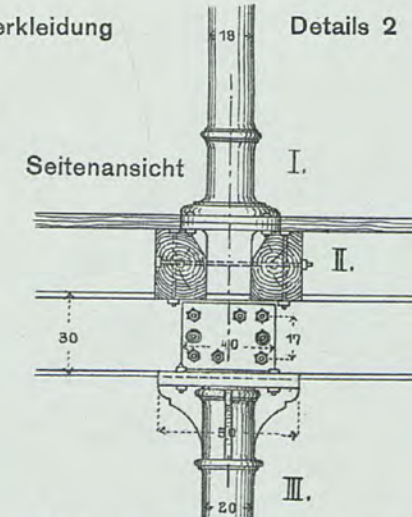
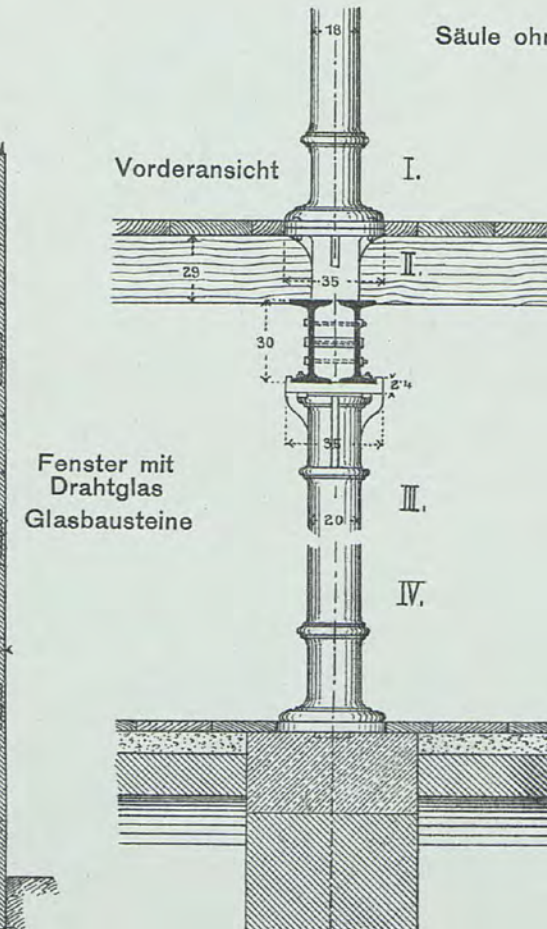
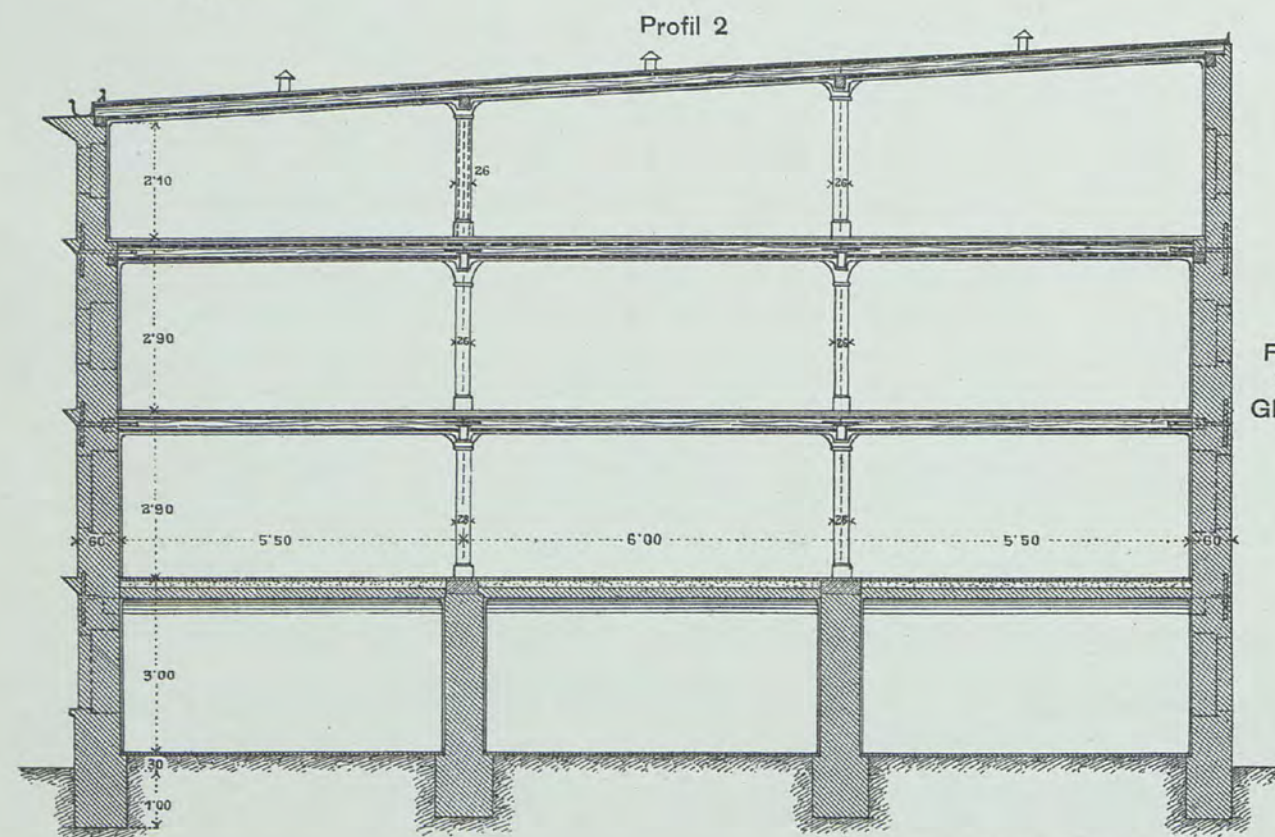

Wagschnitt I

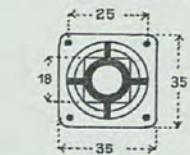

Wagschnitt II

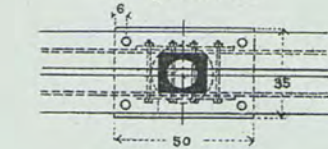

Wagschnitt III



Säulenstoß



Wagschnitt IV

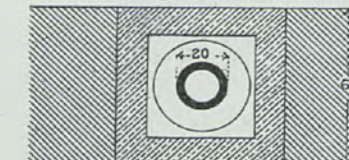

Wagschnitt durch verkleidete Säule V



Die feuergefährliche Eisenkonstruktion muß durch Verkleidung mit Zementputz auf Latten „feuersicher“ ausgebildet werden

100 50 0 1 2 3 4 5 6 7 8 9 10 m.

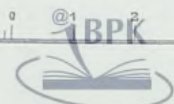

100 90 80 70 60 50 40 30 20 10 0

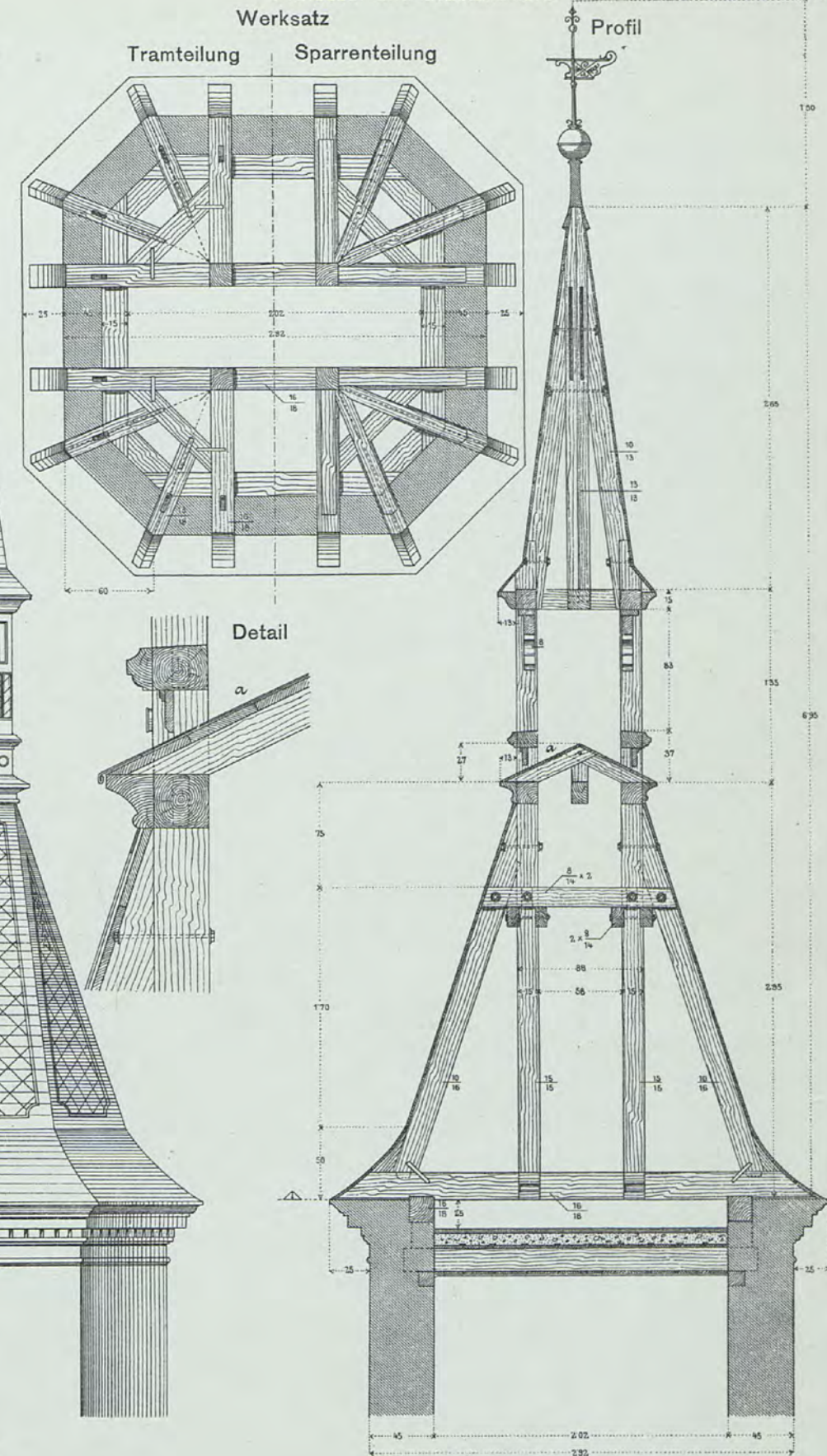
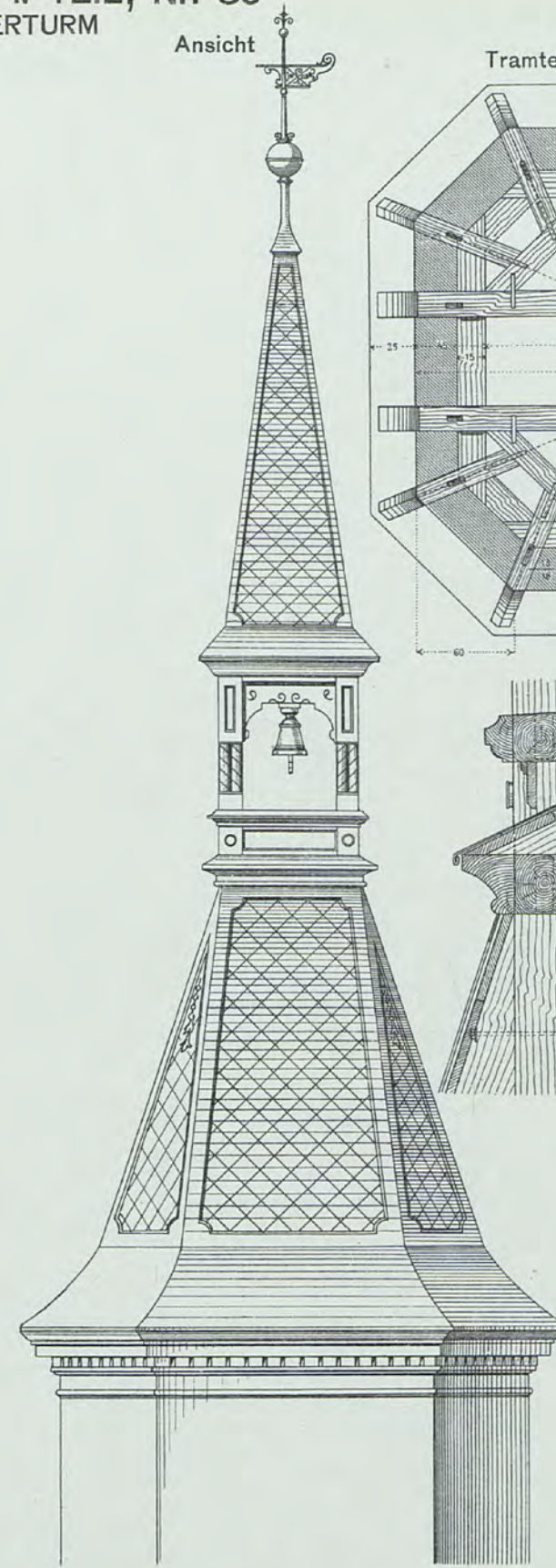
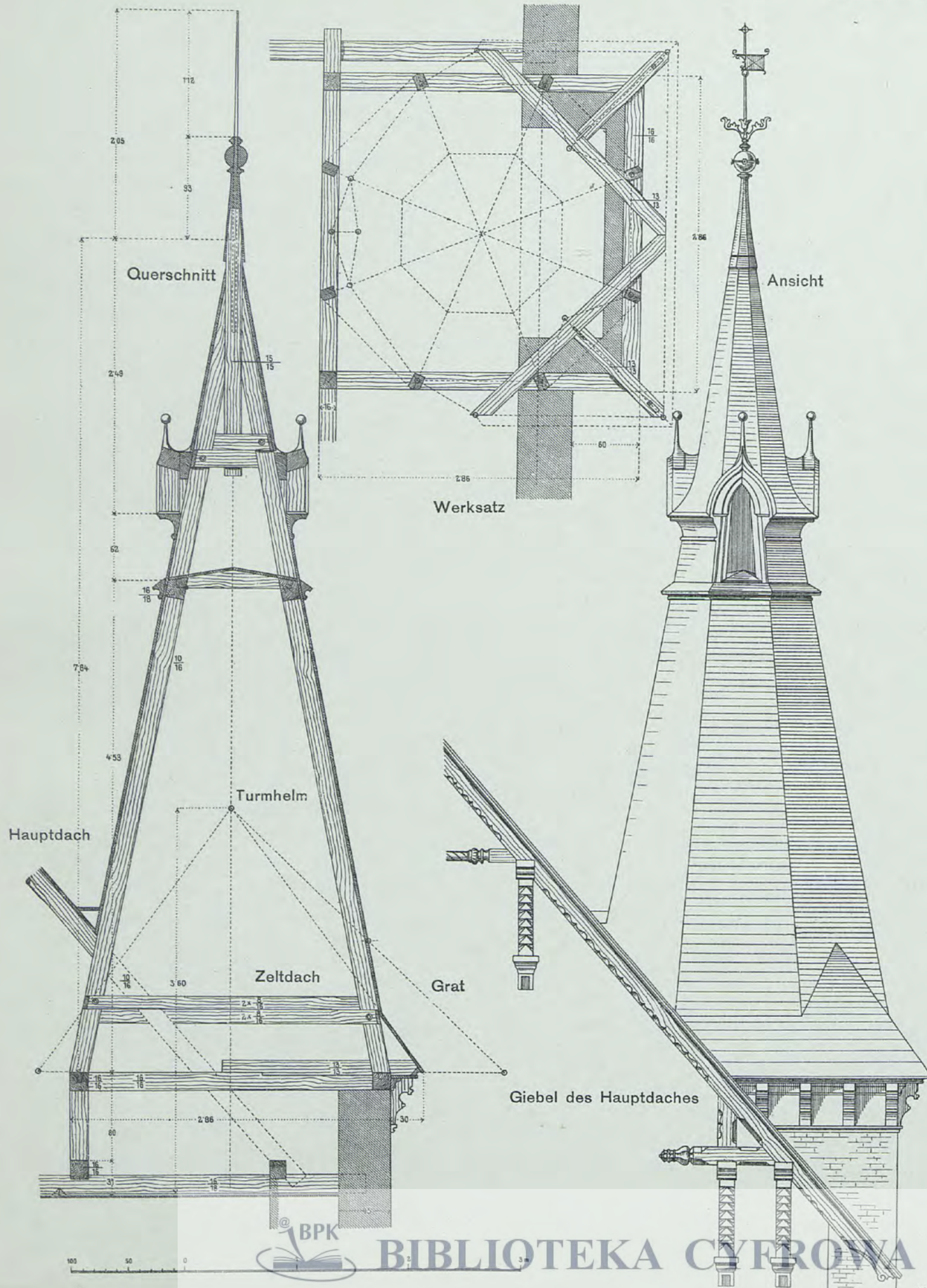

100 50 0

100 50 0 1 2m



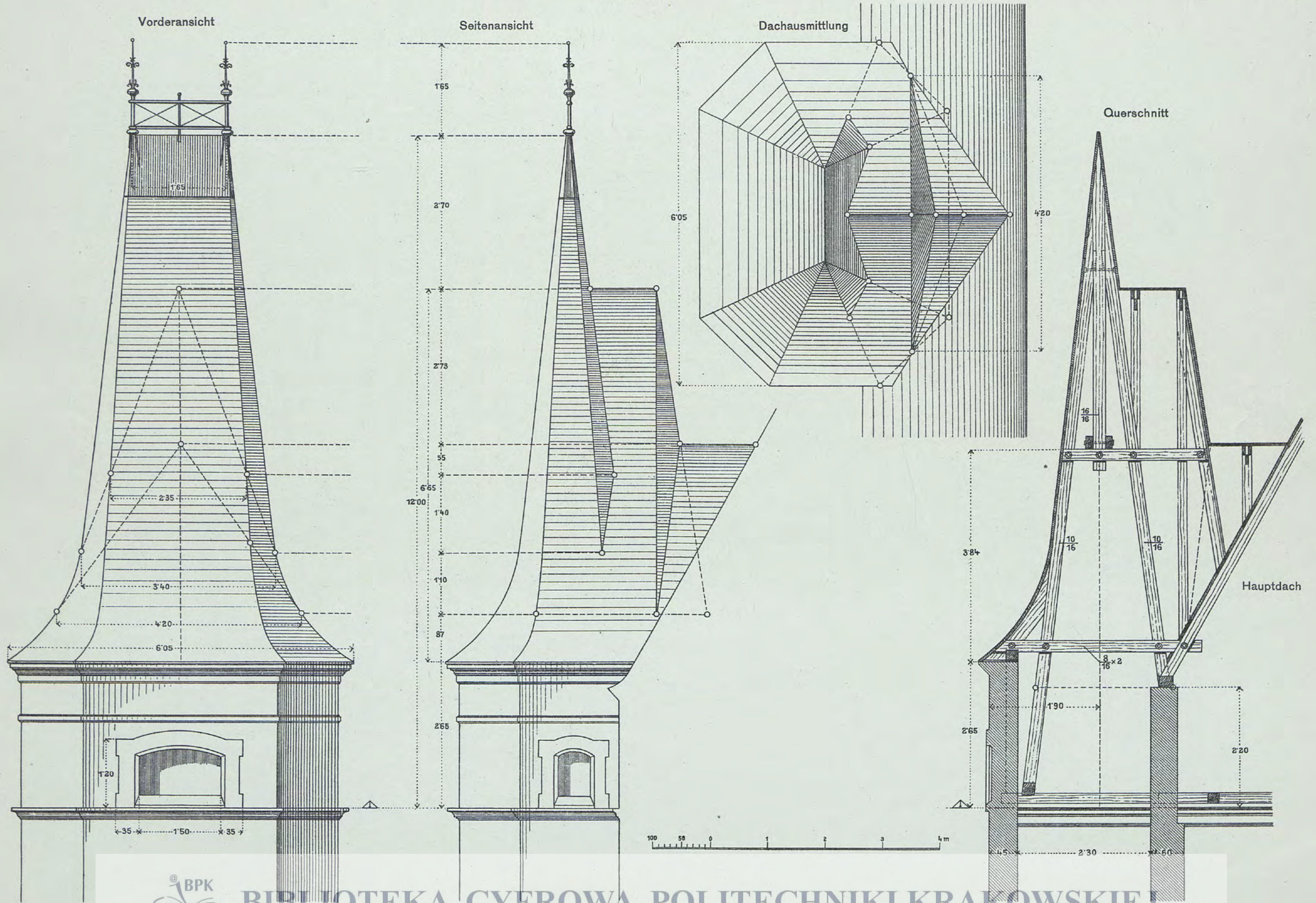

Ansicht der Zimmerung

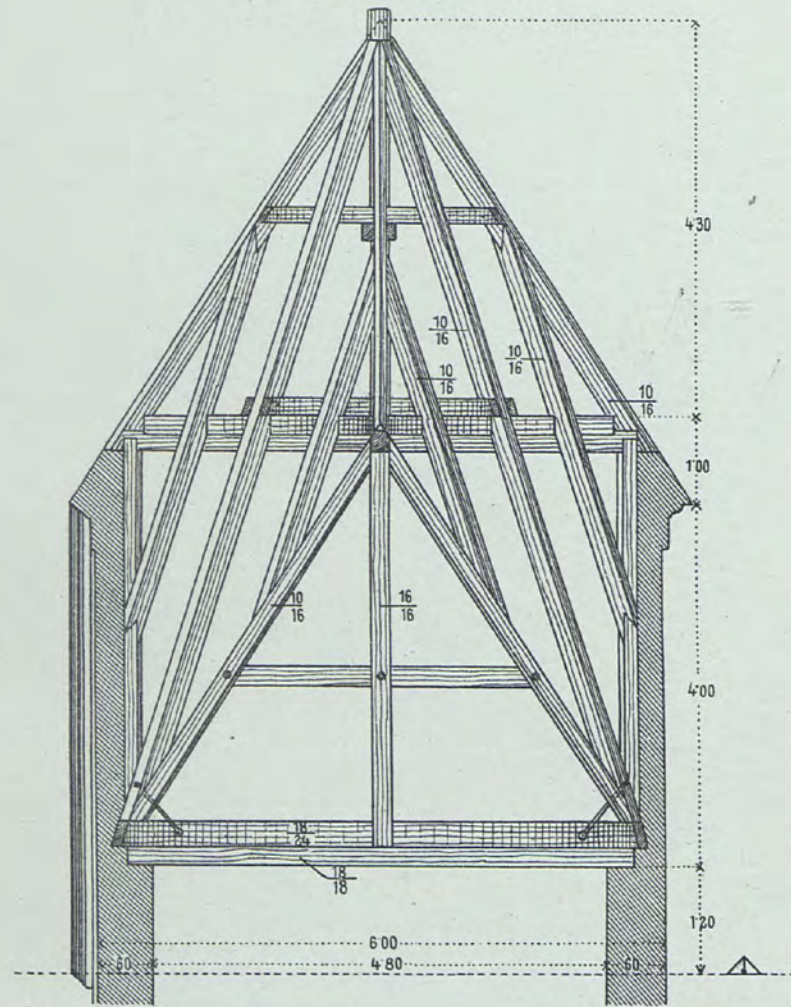

Ansicht im verkleinerten Maßstabe

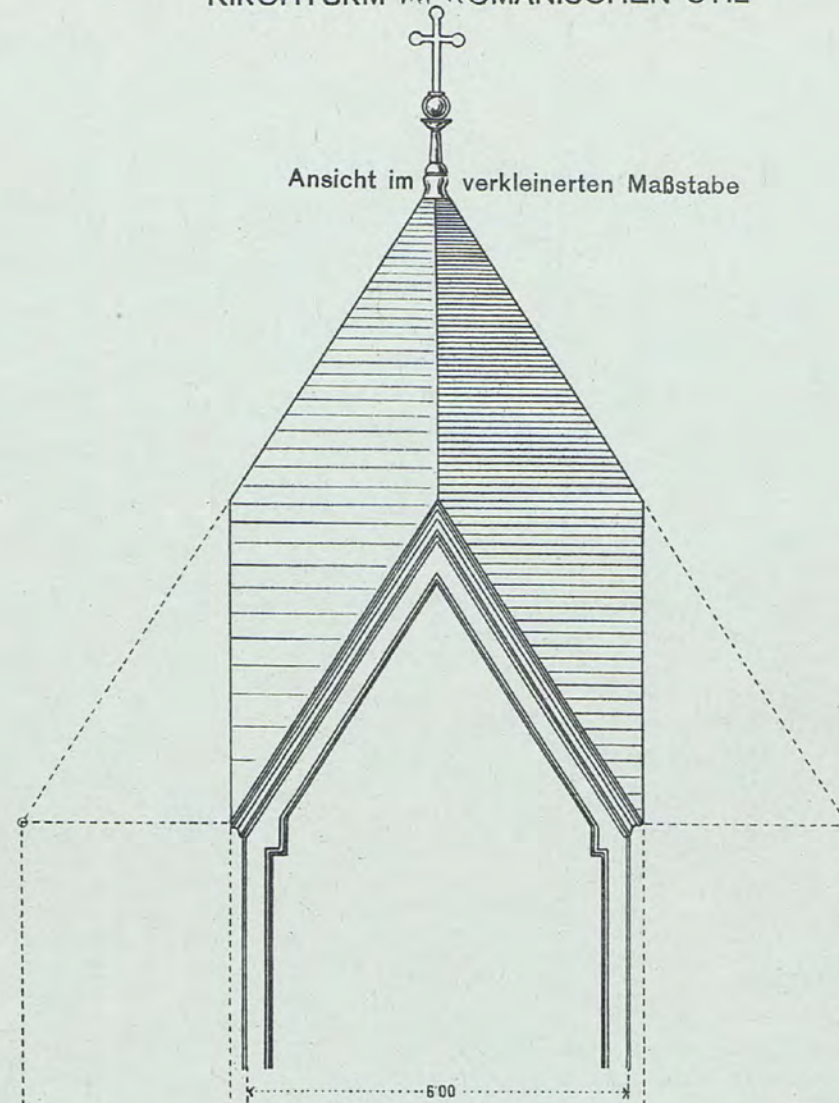

Diagonalschnitt

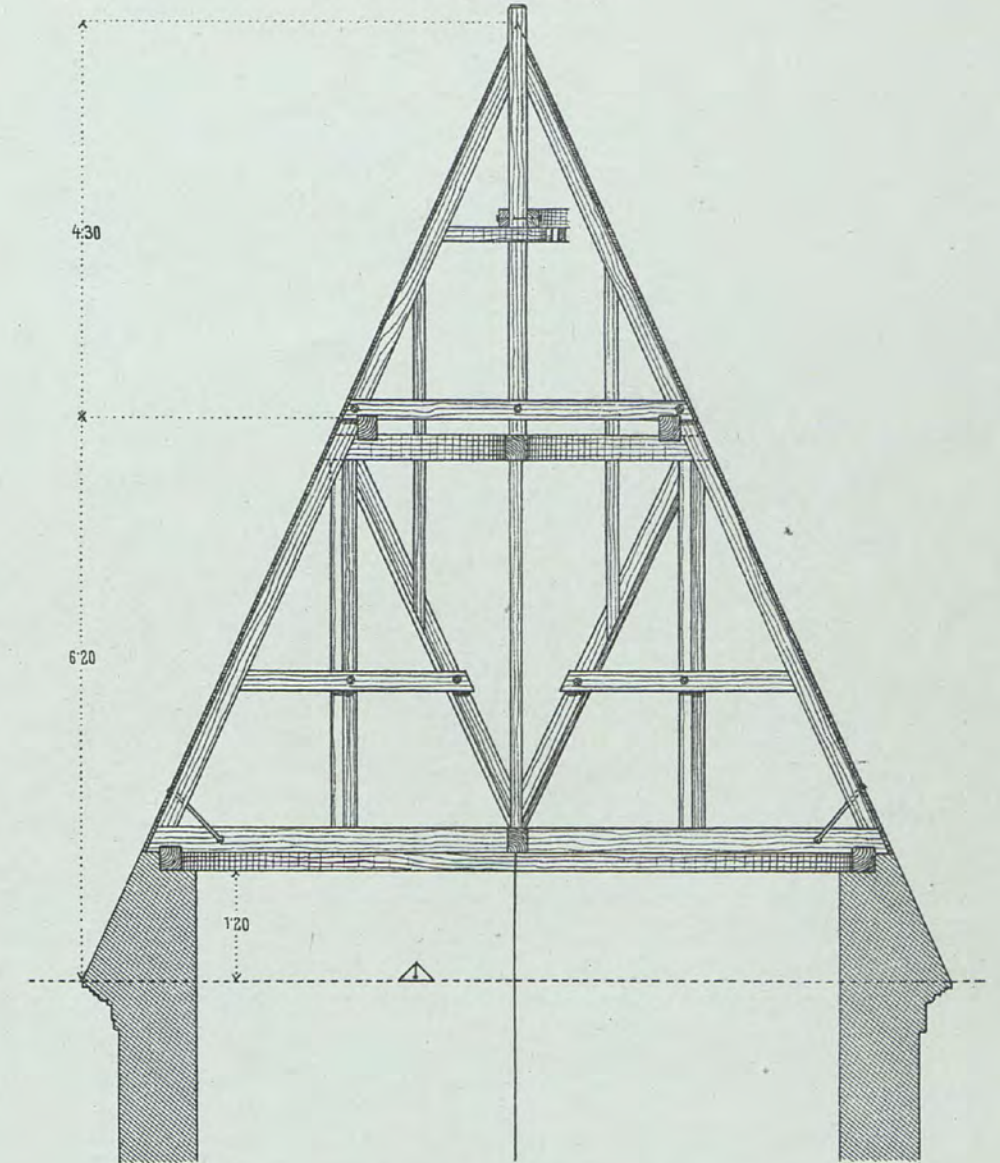

Schwellen- und Tramlage

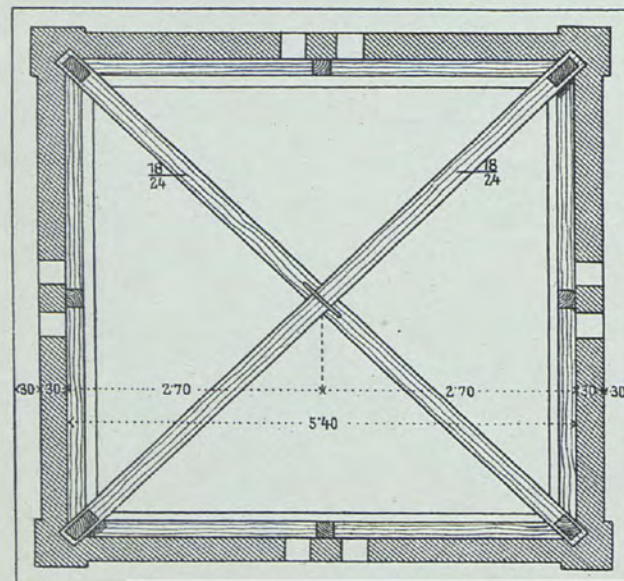

Draufsicht

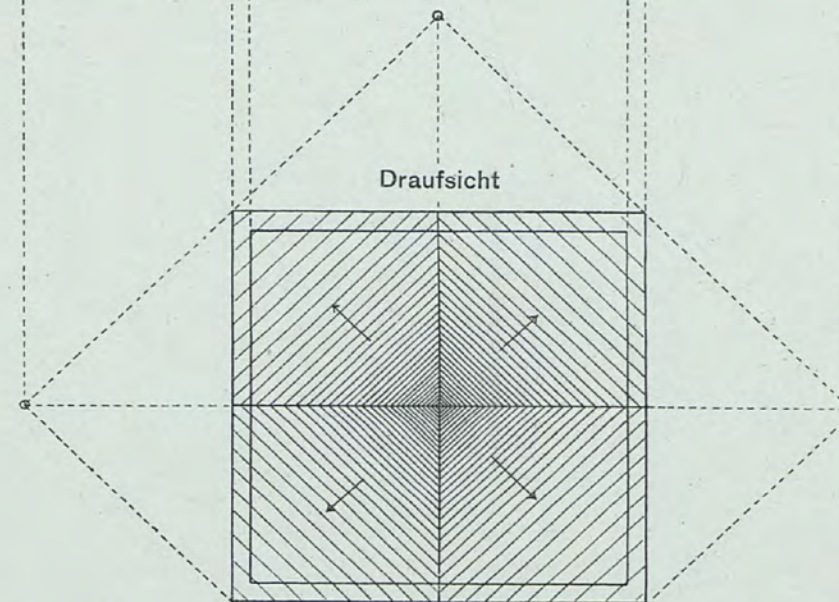

Wagschnitt in Pfettenhöhe

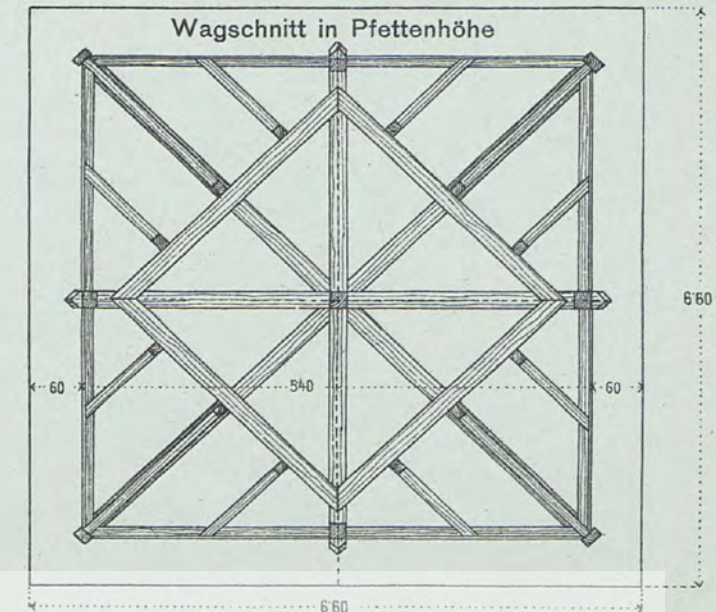

Ansicht 1

Ansicht über Eck 1

Ansicht 2

Ansicht über Eck 2

Normal- und Gratprofil beim Turmhelm und Zeltdach 1

Normal-, Grat- und Ichenprofil beim Turmhelm und Zeltdach 2

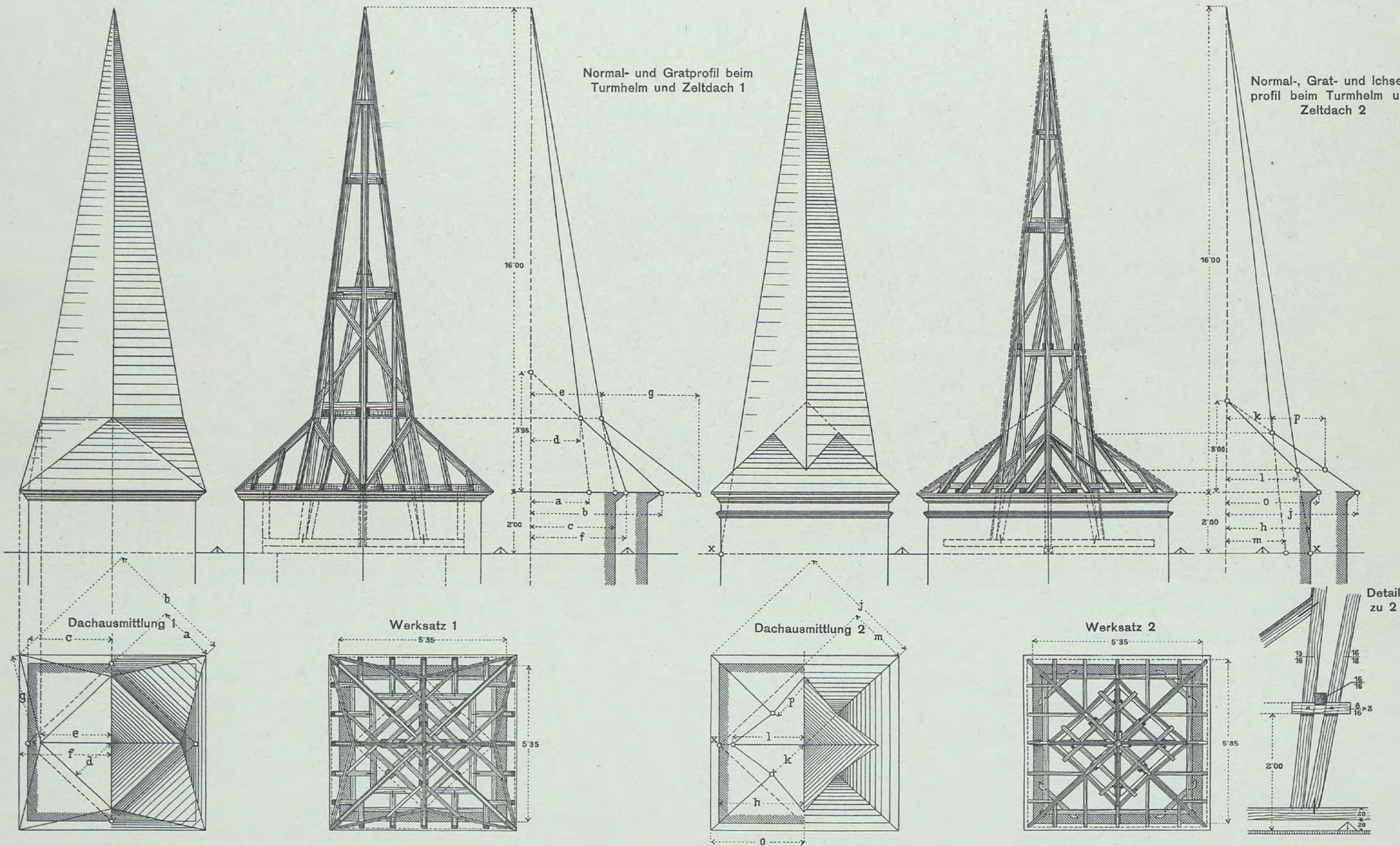

DER ZIMMERER-MEISTER. I. TEIL, Nr. 93
UMBAU DES SÜDTURMES DER DECHANTEIKIRCHE IN PRACHATITZ (BÖHMEN)

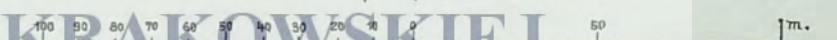
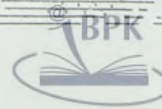
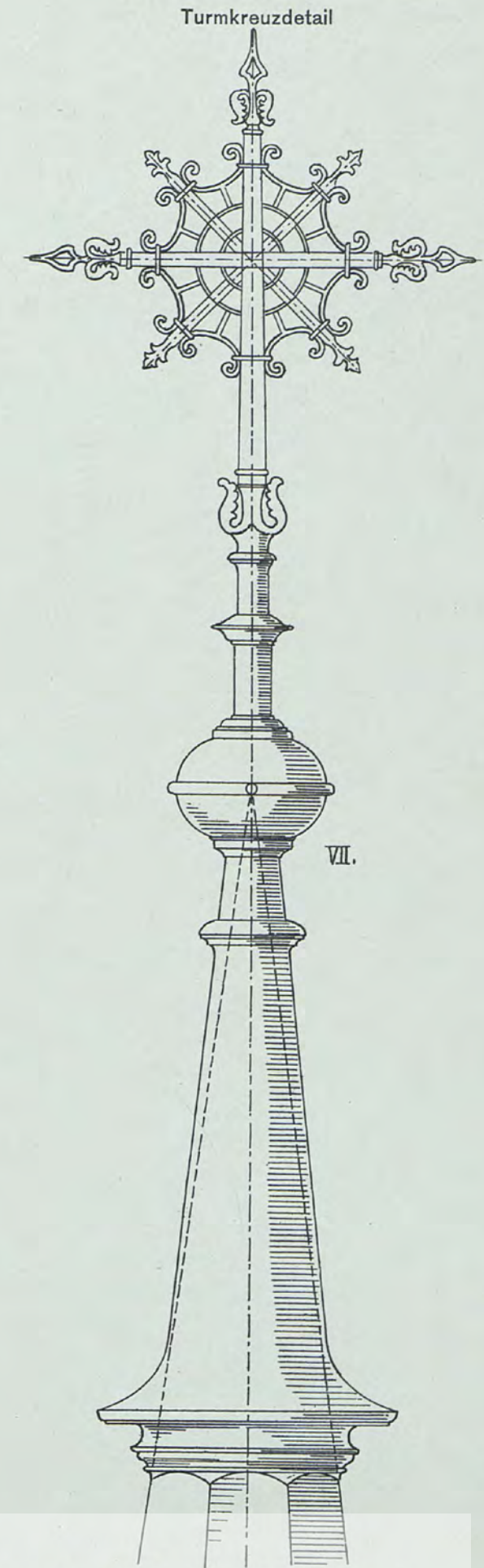
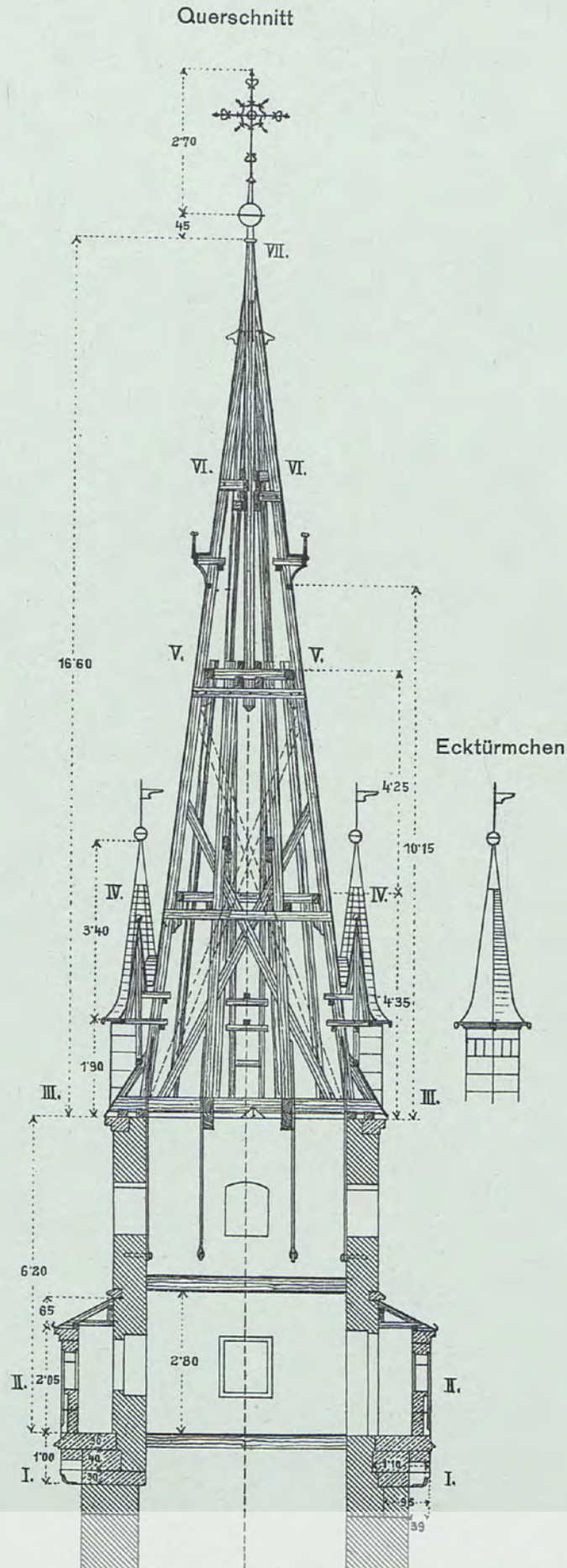
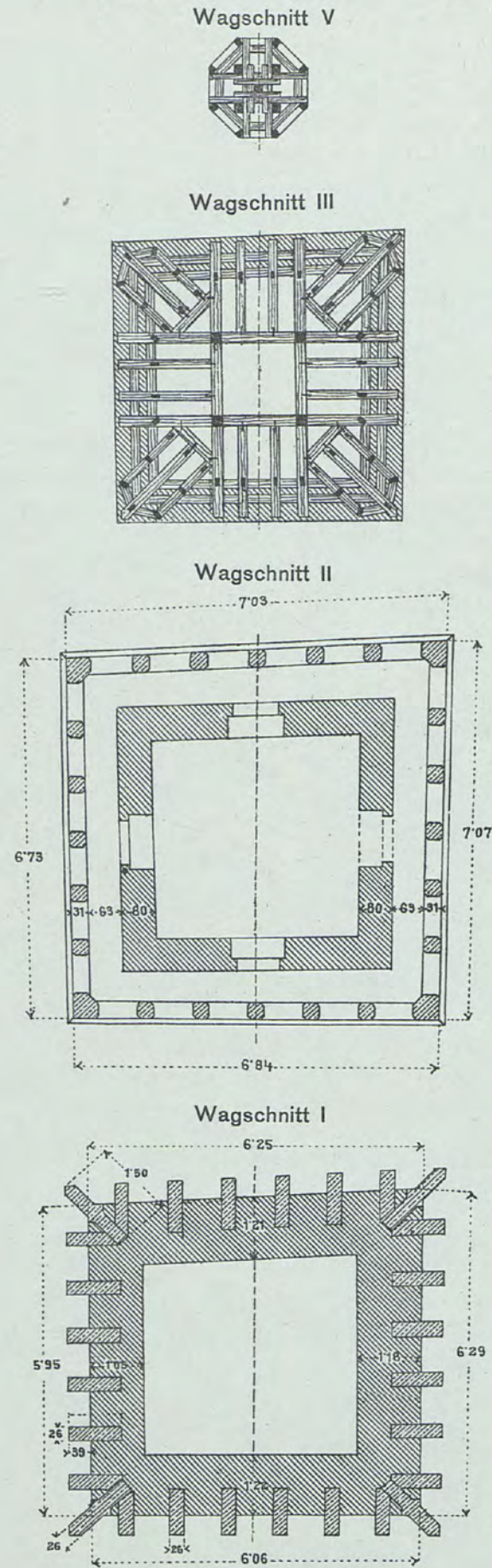
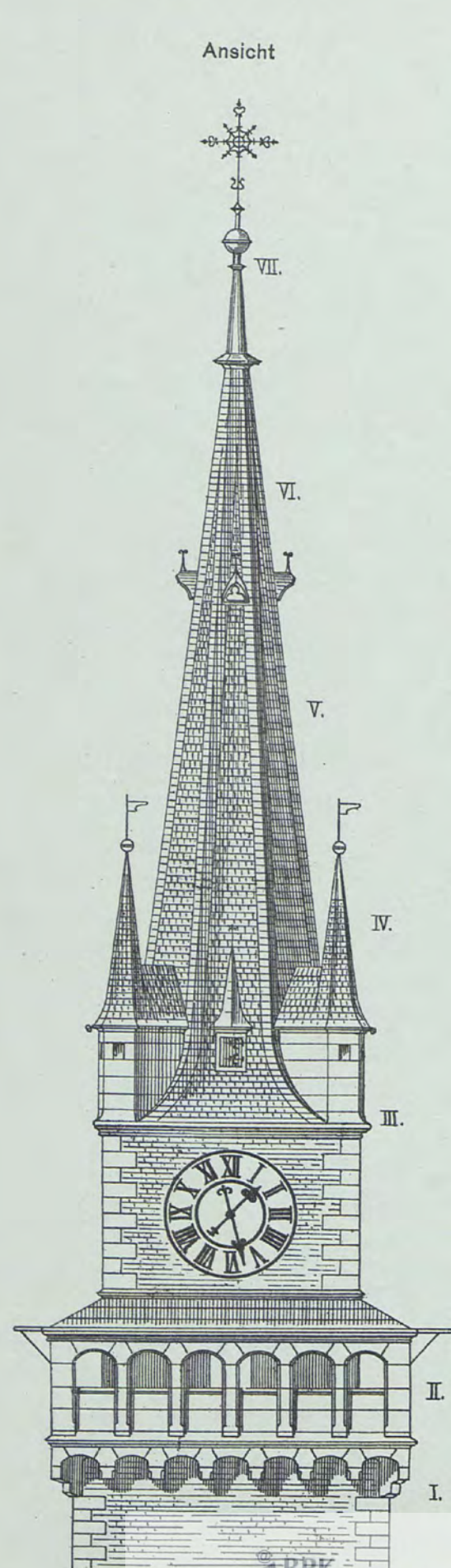

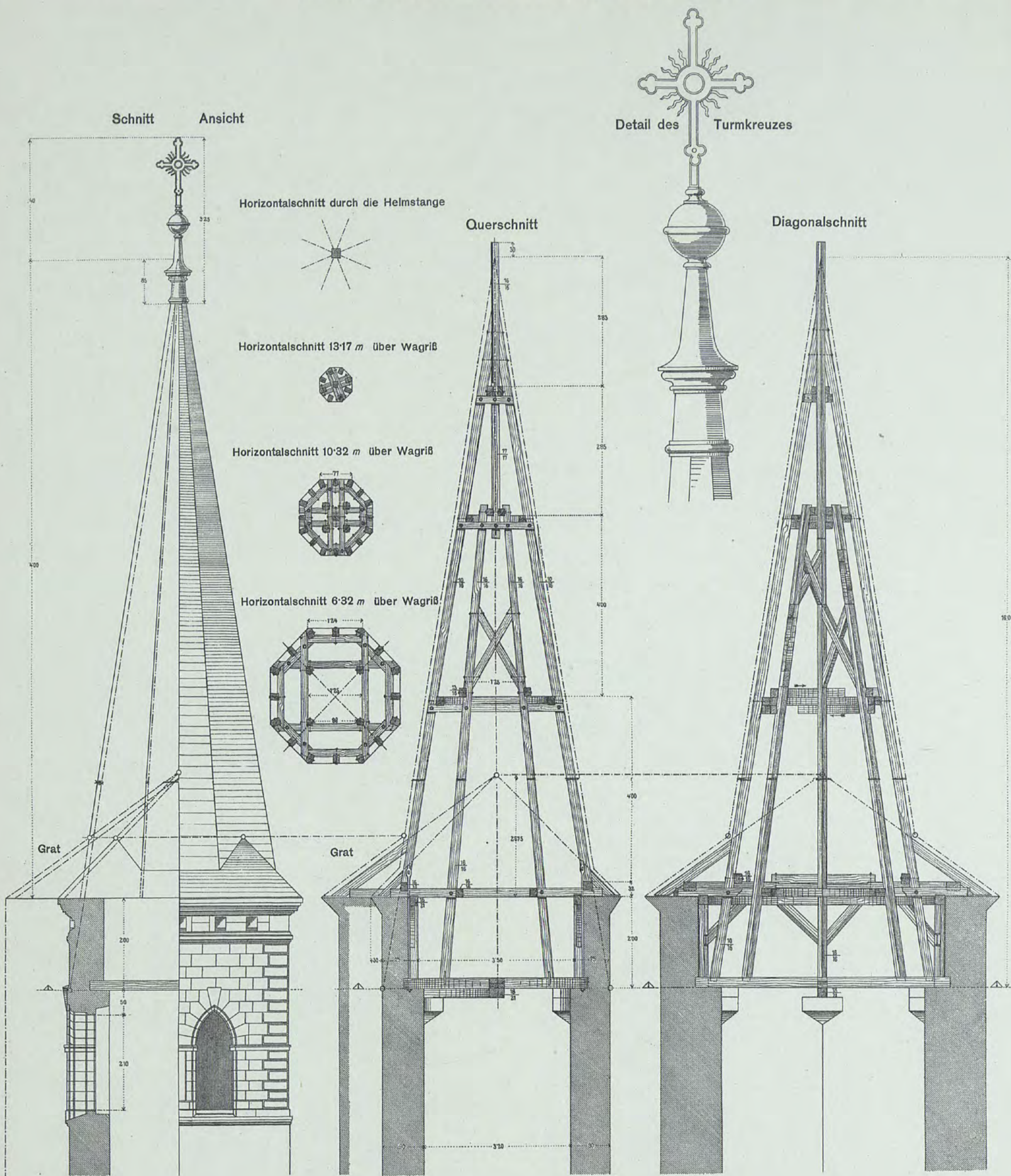

DER ZIMMERER-MEISTER, I. TEIL, Nr. 94
KIRCHTUM VOM VIERECK IN EIN ACHECK ÜBERGEHEND

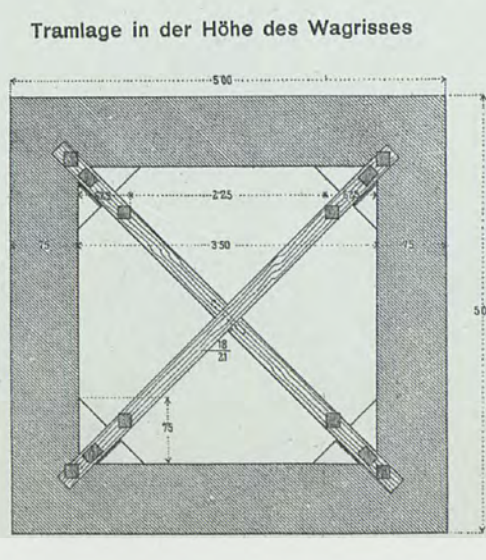
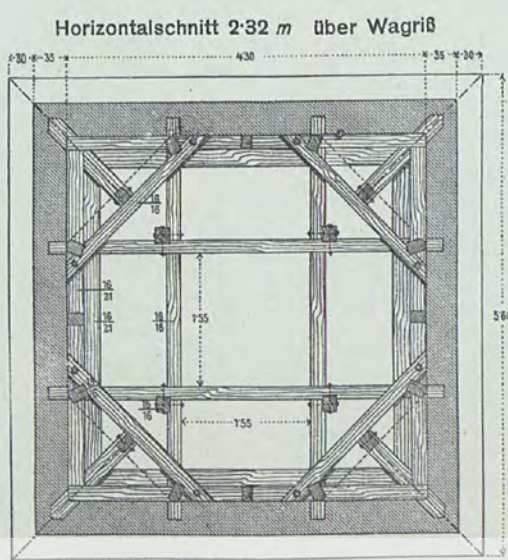
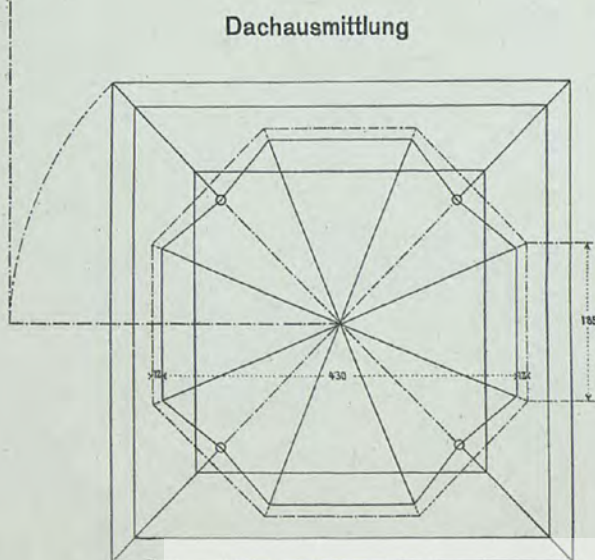

DER ZIMMERER-MEISTER, I. TEIL, Nr. 95
 KIRCHTURM FÜR DIE ST. NIKOLAI-KIRCHE IN FLENSBURG
 (DER HÖCHSTE HÖLZERNE KIRCHTURM IN EUROPA)

Professor und Stadtzimmerer-Meister
 A. BAUDOIN, Wien

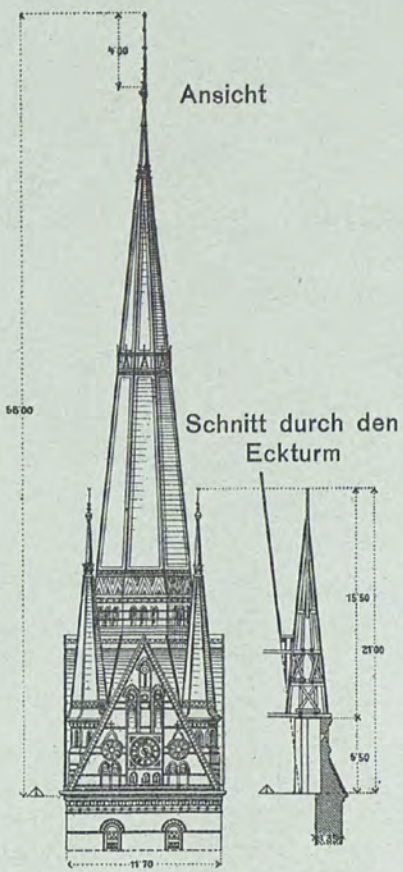
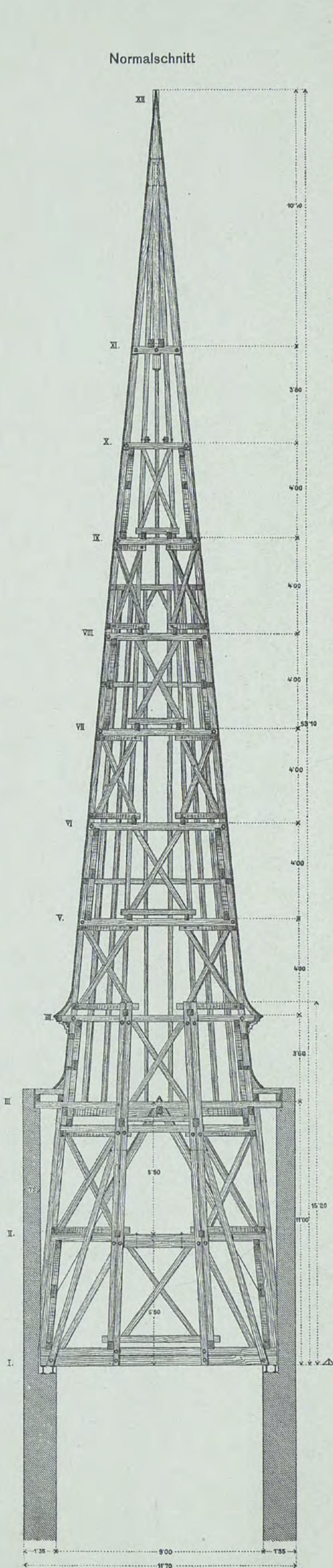

Wagschnitt VIII

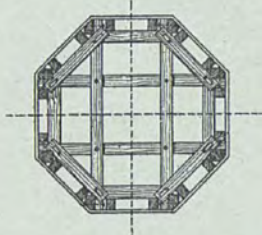

Wagschnitt VI

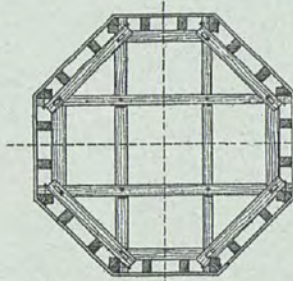

Wagschnitt IV

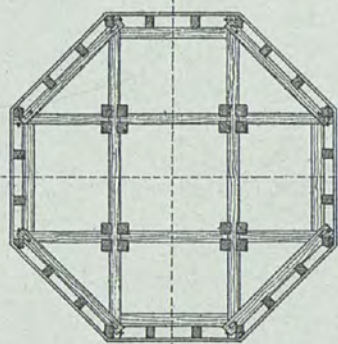

Wagschnitt I

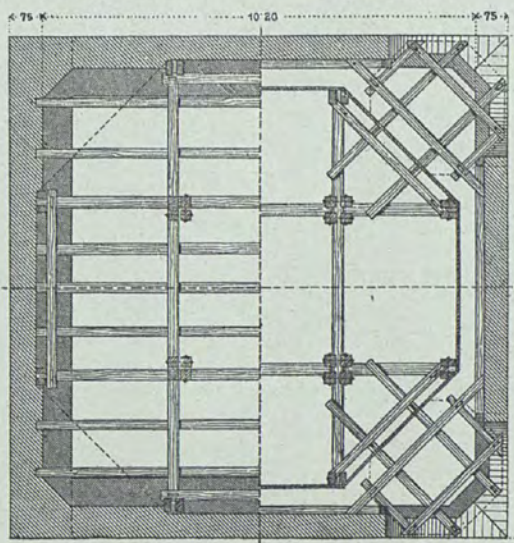

Wagschnitt II

Dachdraufsicht

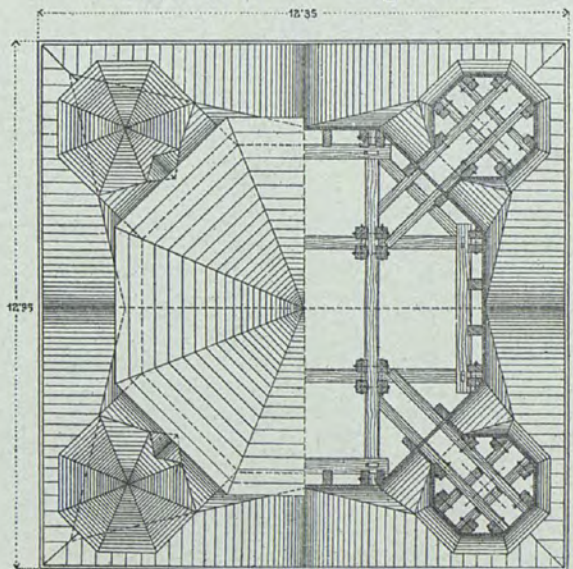

Wagschnitt III

Wagschnitt XII



Wagschnitt XI

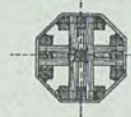

Wagschnitt X

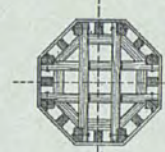

Wagschnitt IX

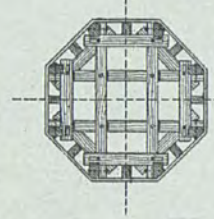

Wagschnitt VII

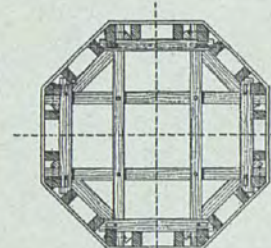

Wagschnitt V

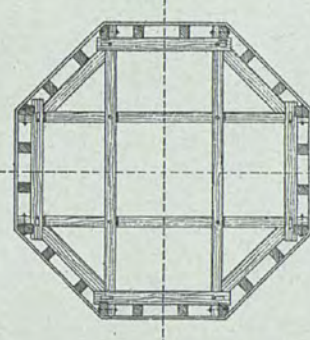

DER ZIMMERER-MEISTER, I. TEIL, Nr. 95
 KIRCHTURM FÜR DIE ST. NIKOLAI-KIRCHE IN FLENSBURG
 (DER HÖCHSTE HÖLZERNE KIRCHTURM IN EUROPA)

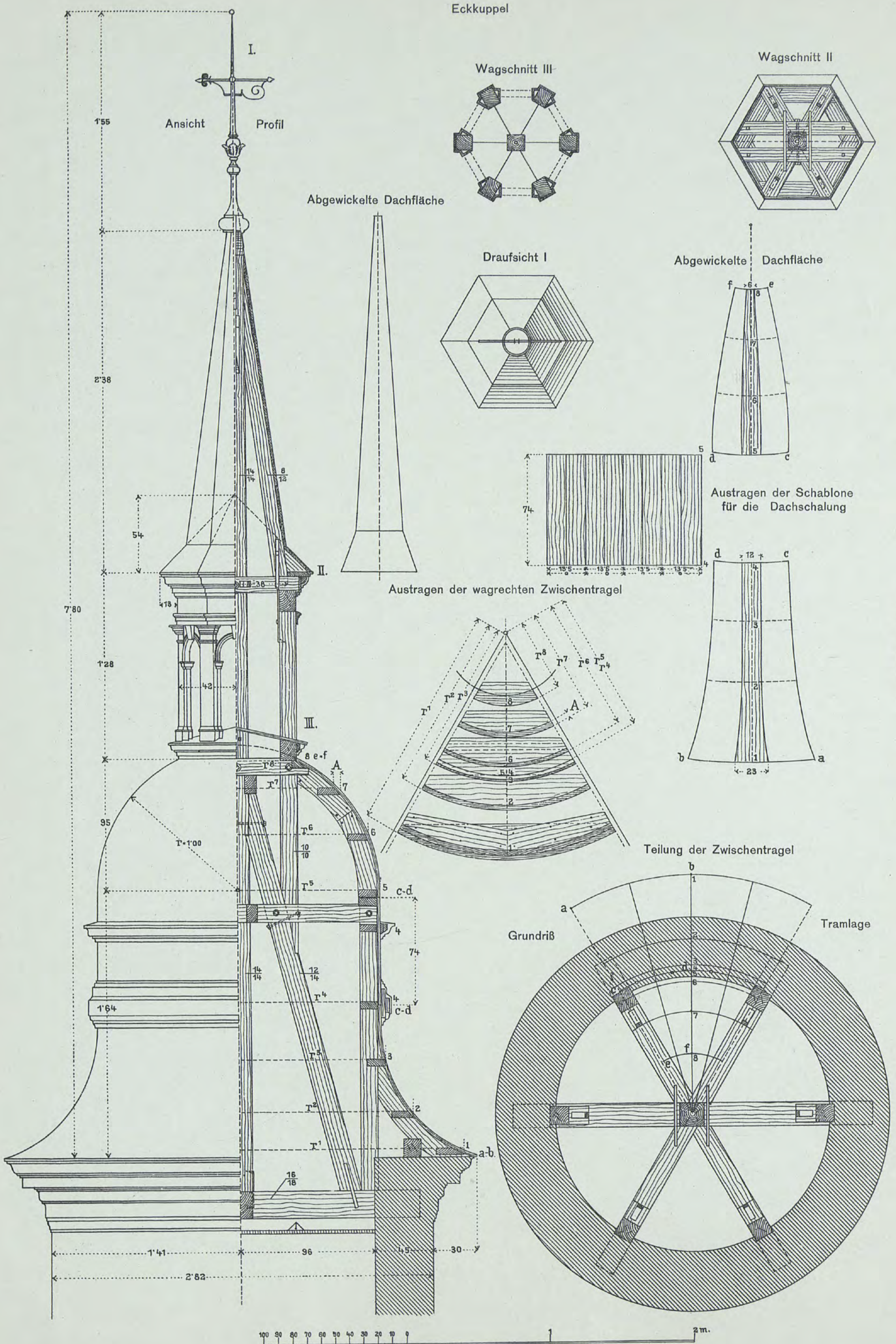

DER ZIMMERER-MEISTER, I. TEIL, Nr. 96
KUPPELDACH

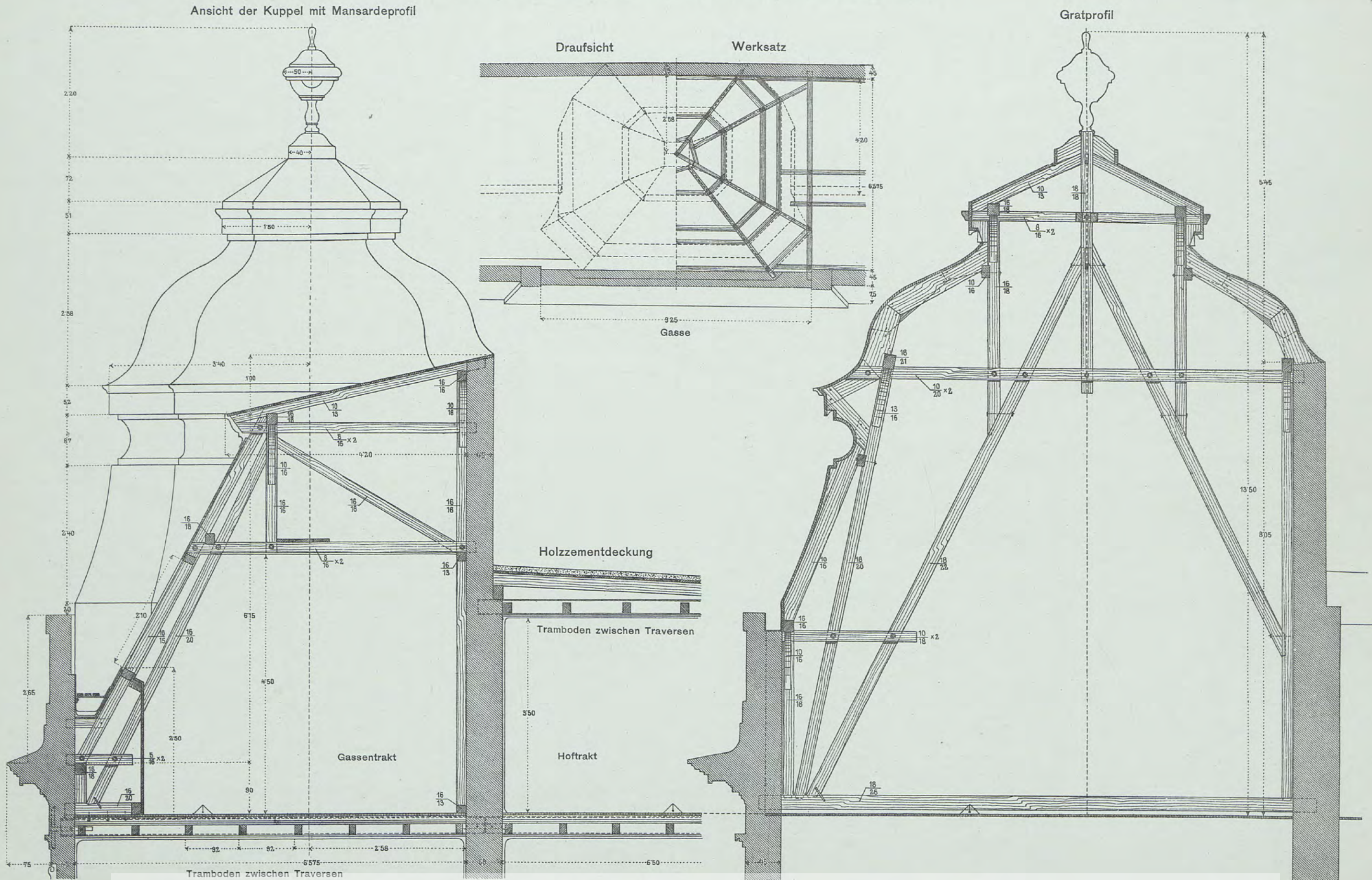

DER ZIMMERER-MEISTER, I. TEIL, Nr. 98
MITTELKUPPEL FÜR EIN WIENER WOHNHAUS

Professor und Stadtzimmerer-Meister A. BAUDOUIN, Wien

Gratprofil

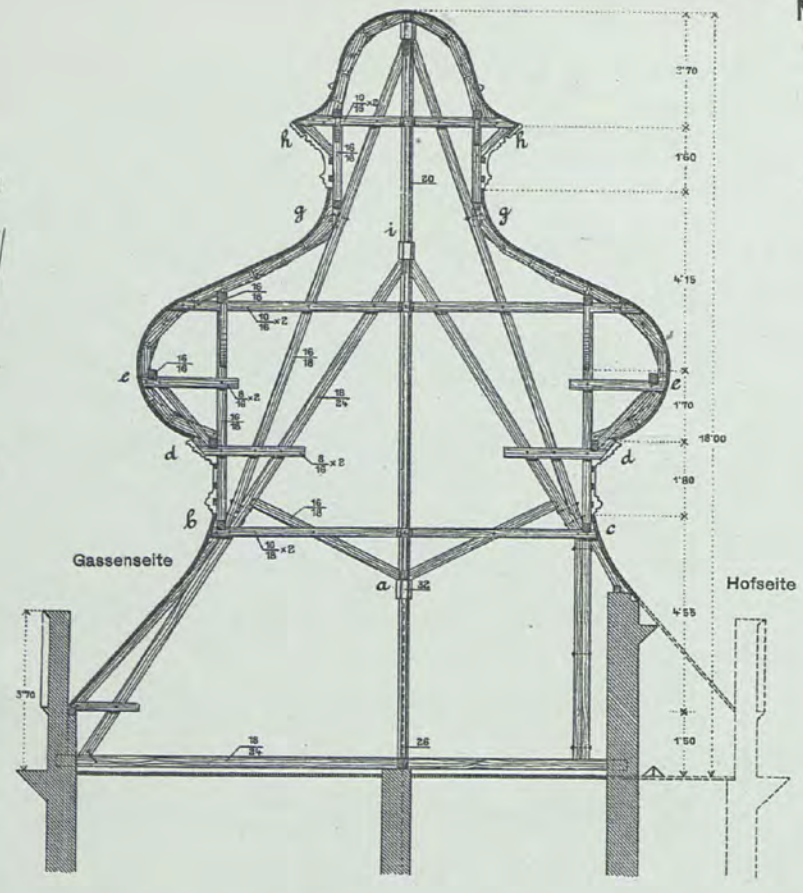

Detail

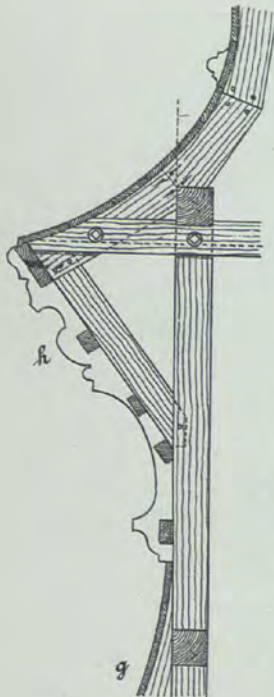

Detail

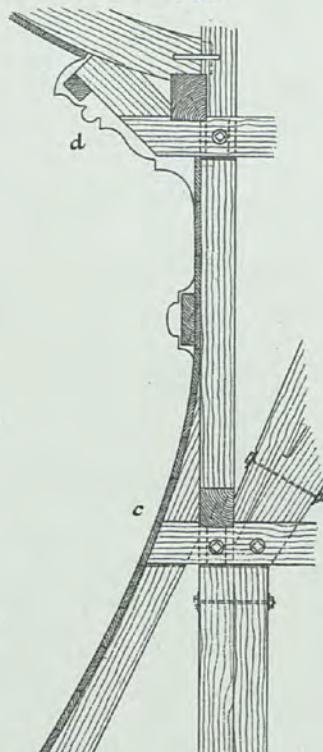

Normalprofil

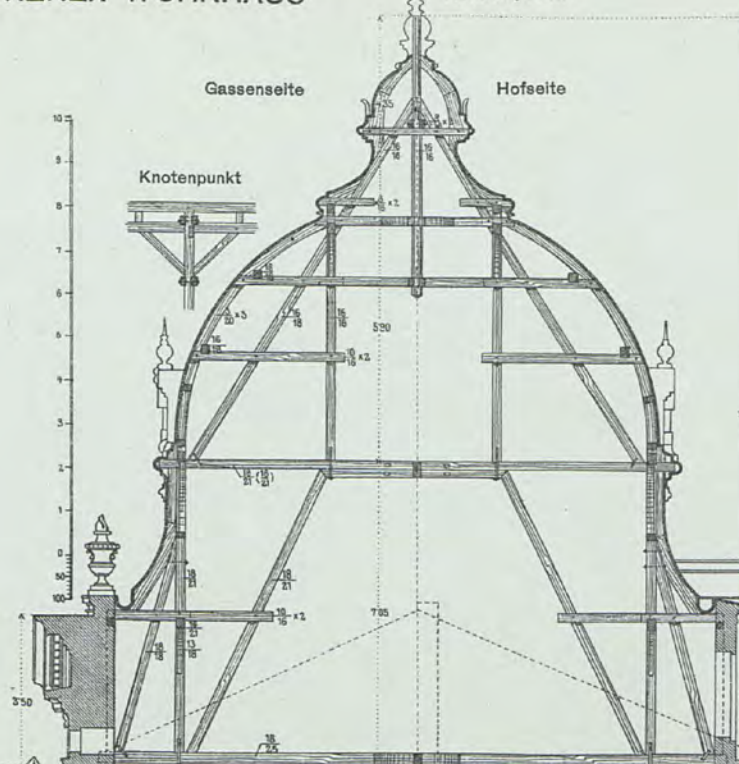

Grundriß

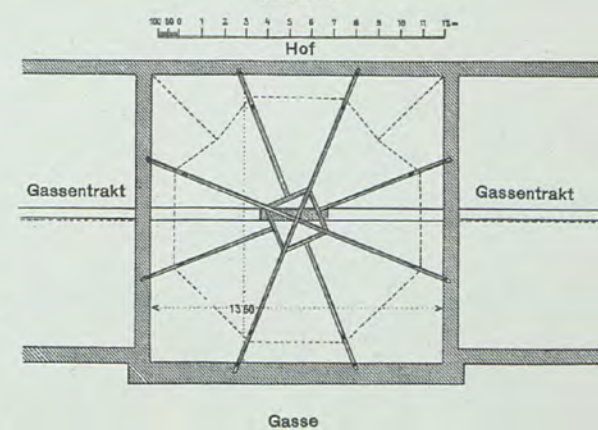

Dachdraufsicht

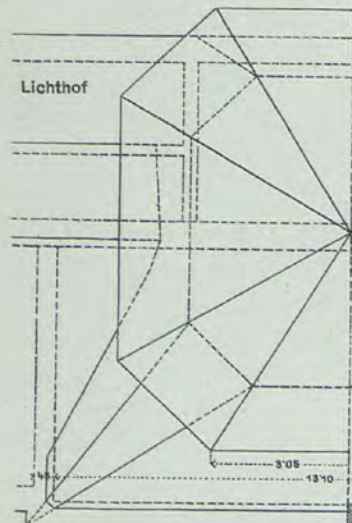

Bundtramlage

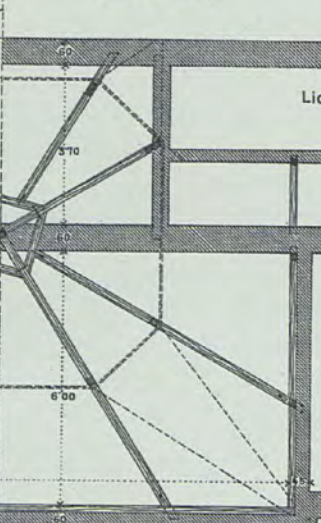

Horizontalschnitt 6.05 m über Wagriß

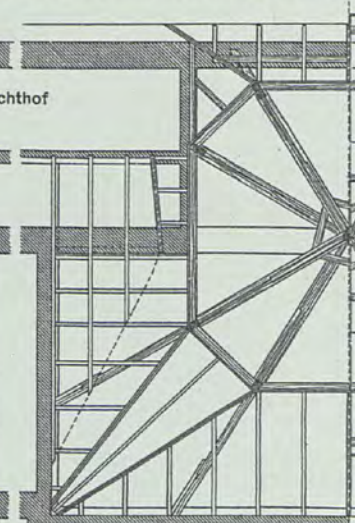

Werksatz mit Sparren



Details

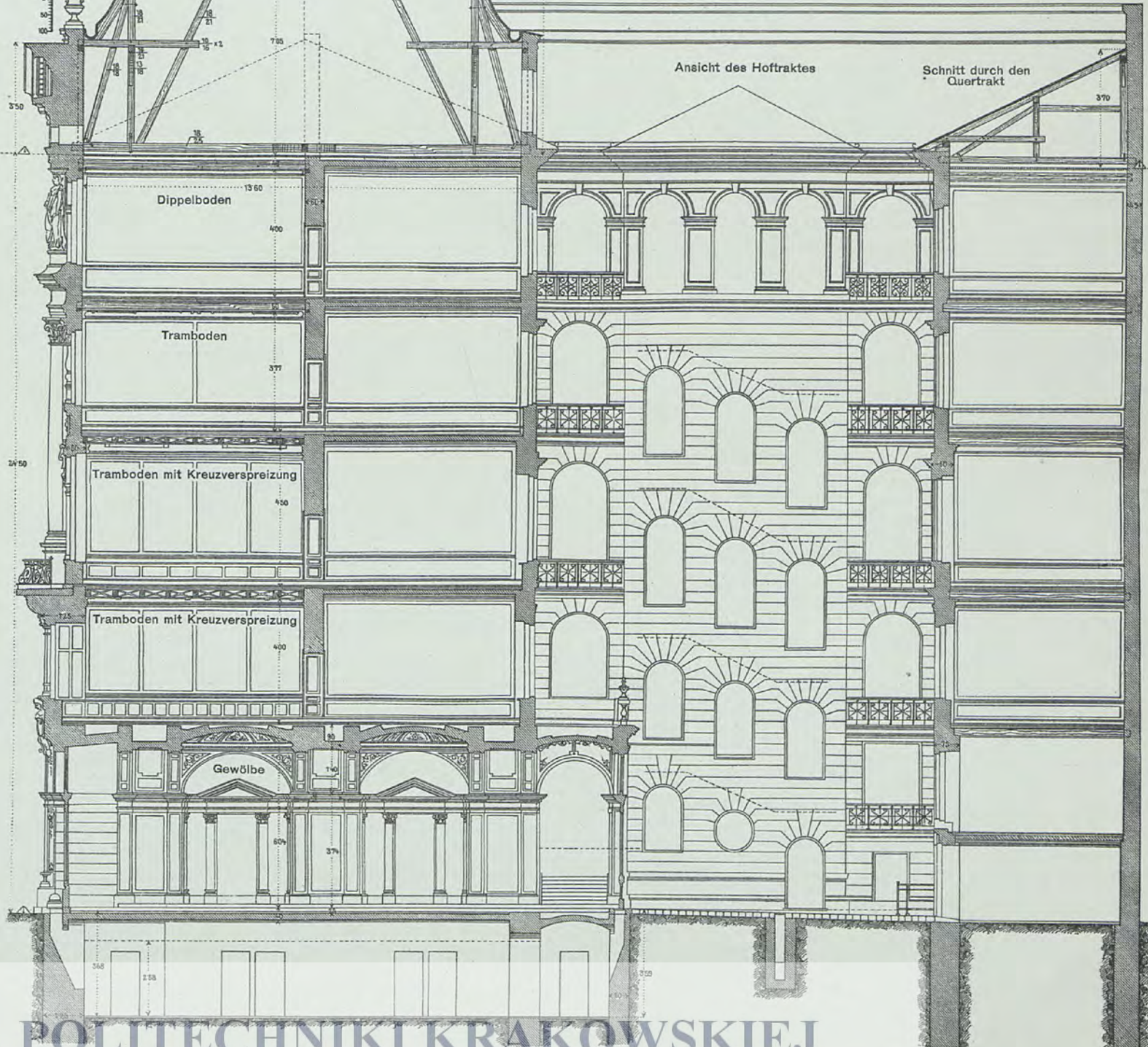
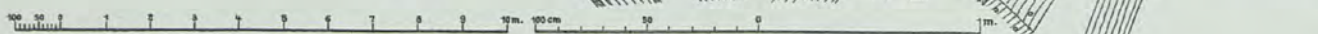
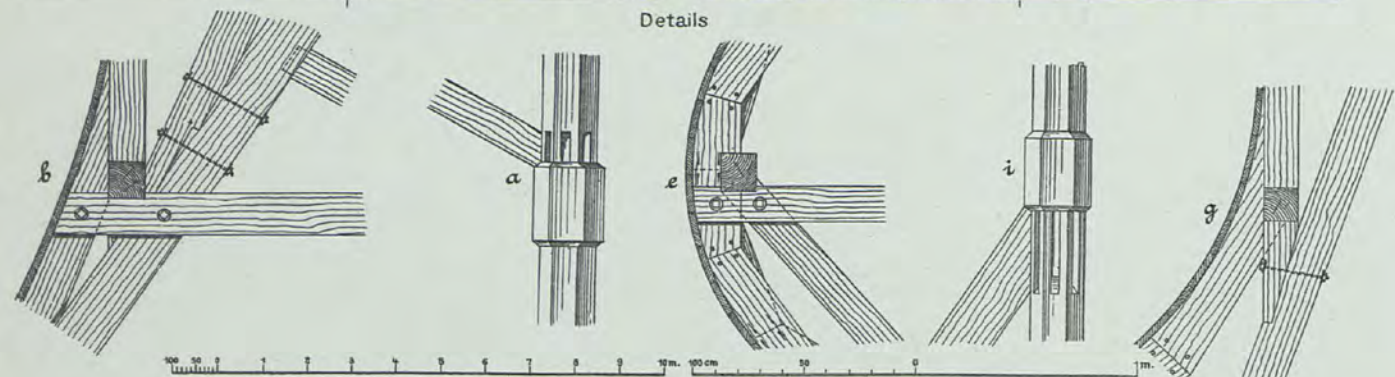

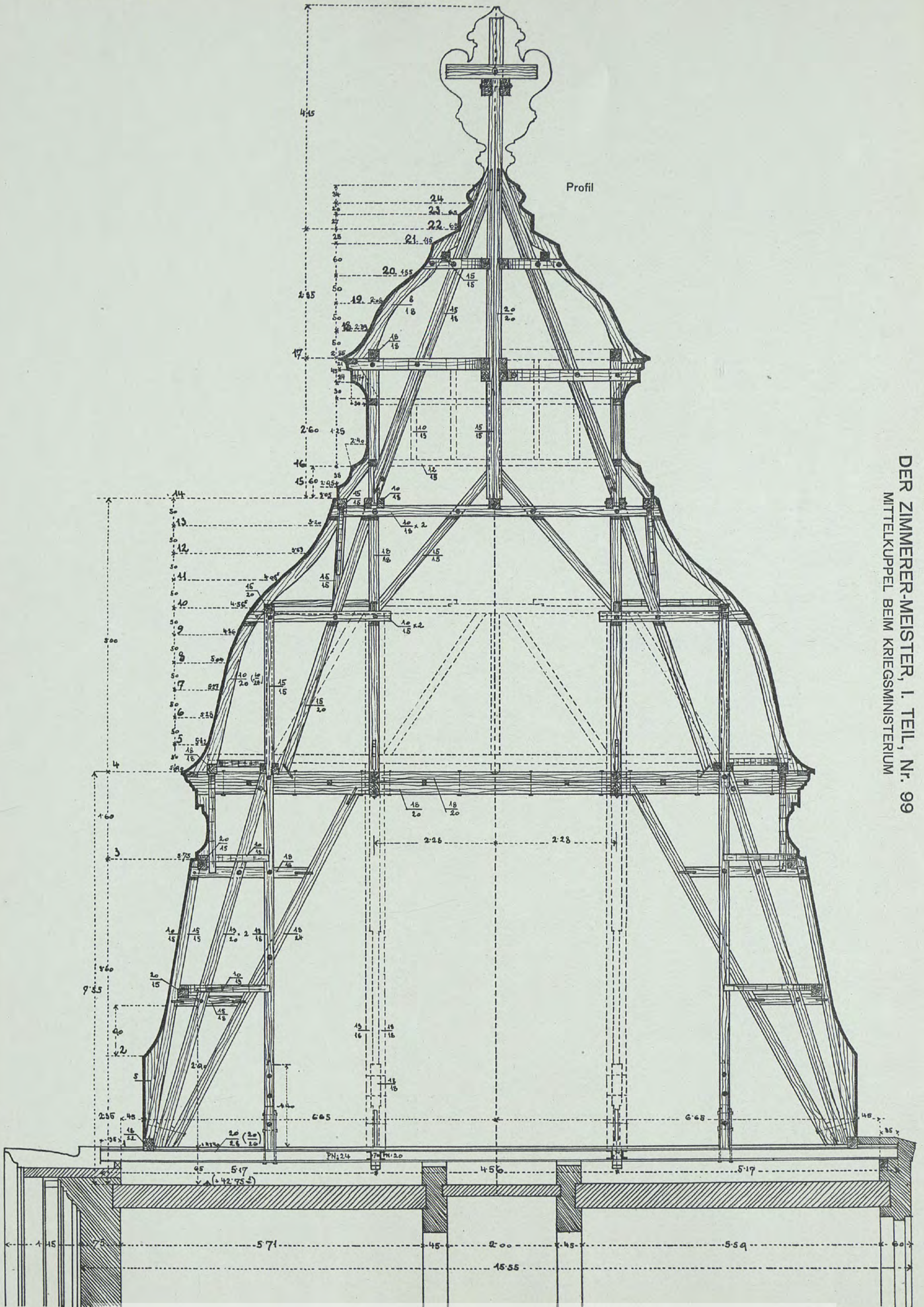

DER ZIMMERER-MEISTER, I. TEIL, Nr. 99
MITTELKUPPEL BEIM KRIEGSMINISTERIUM

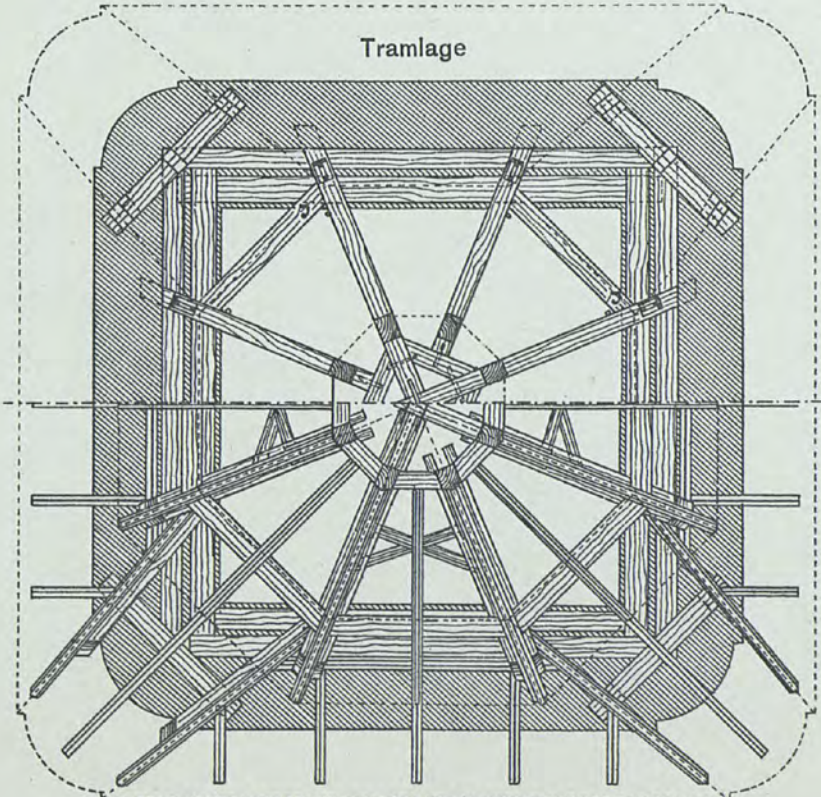
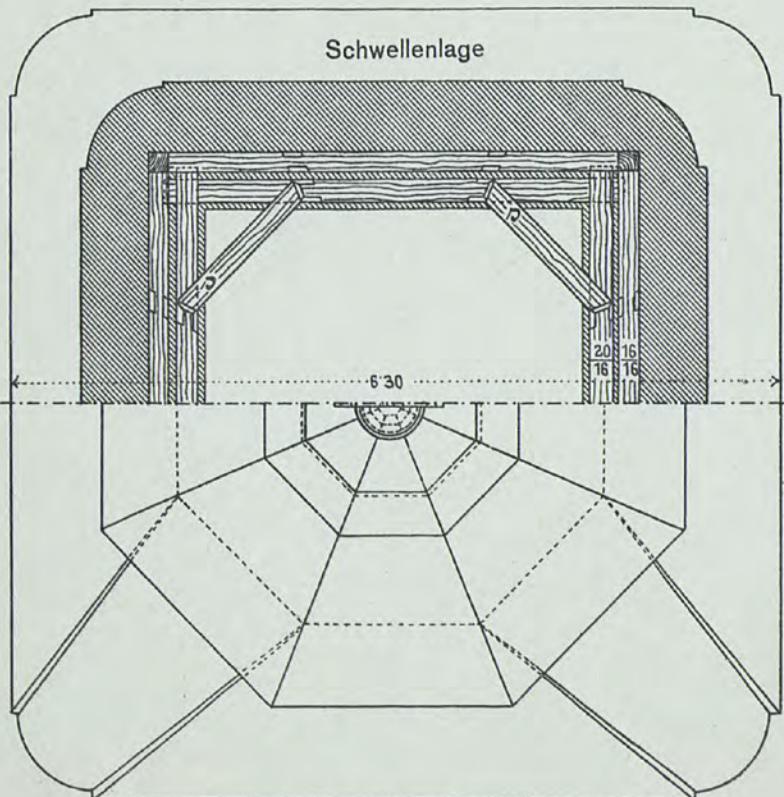
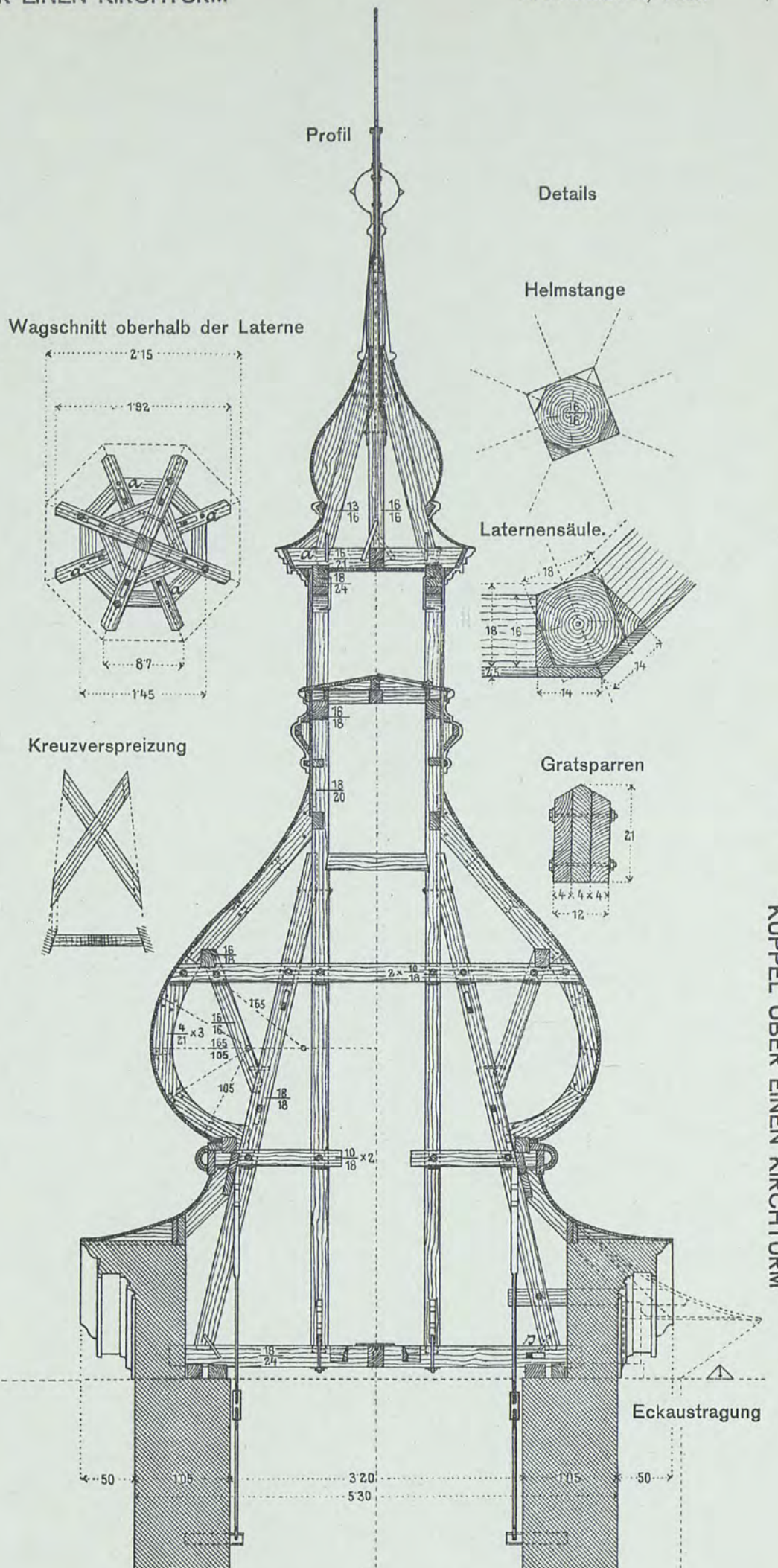
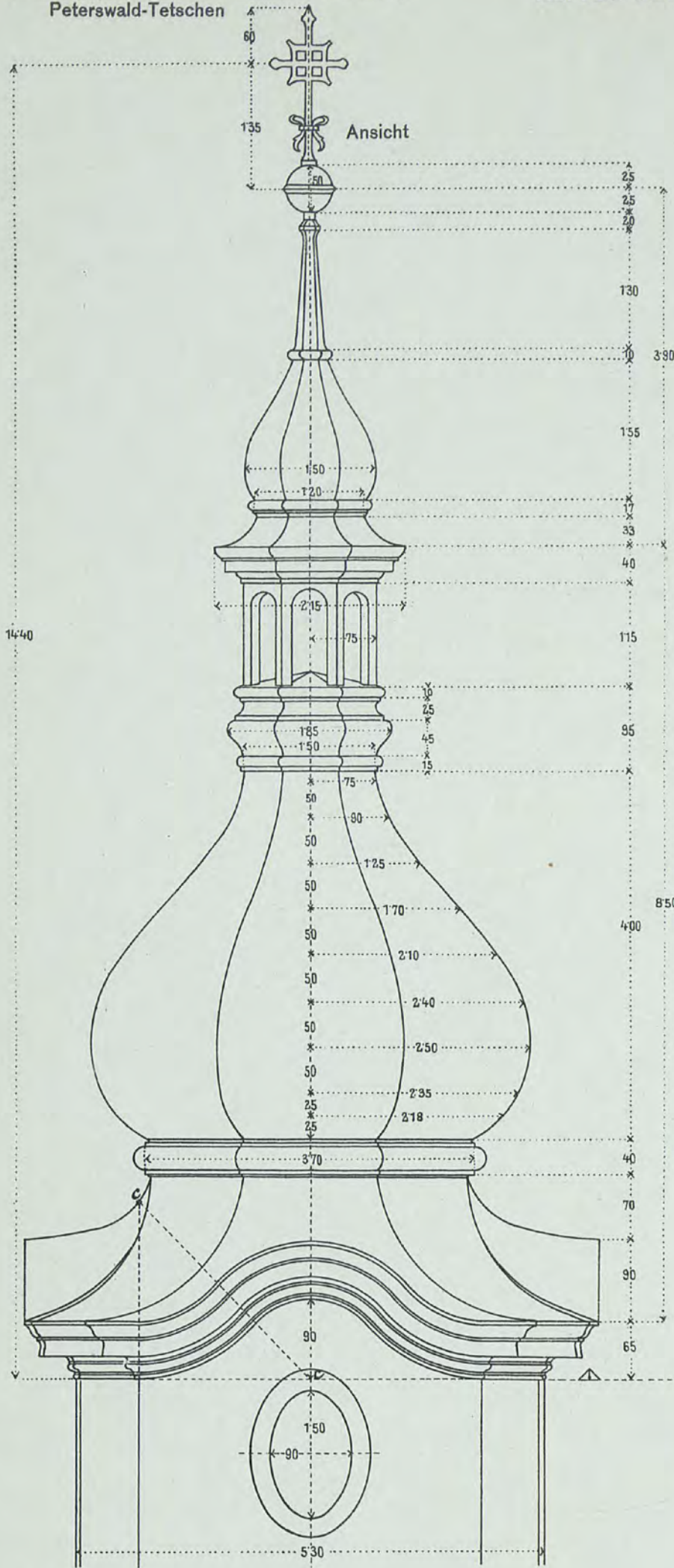

Adaptierung der Kirche in Modletin bei Chotěboř, Böhmen

Querschnitt

Ansicht

Abgewickelte Dachflächen

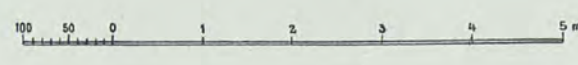
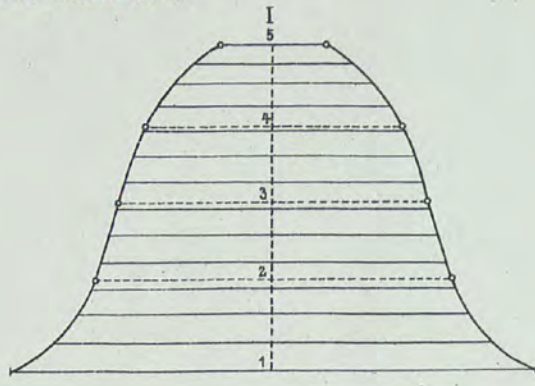
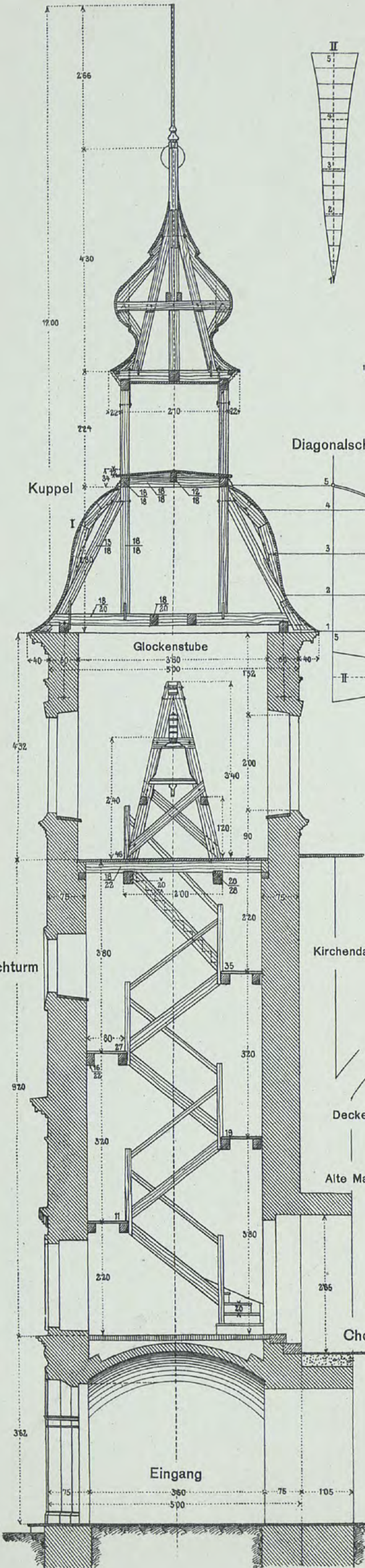

Diagonalschnitt

Grataustragung

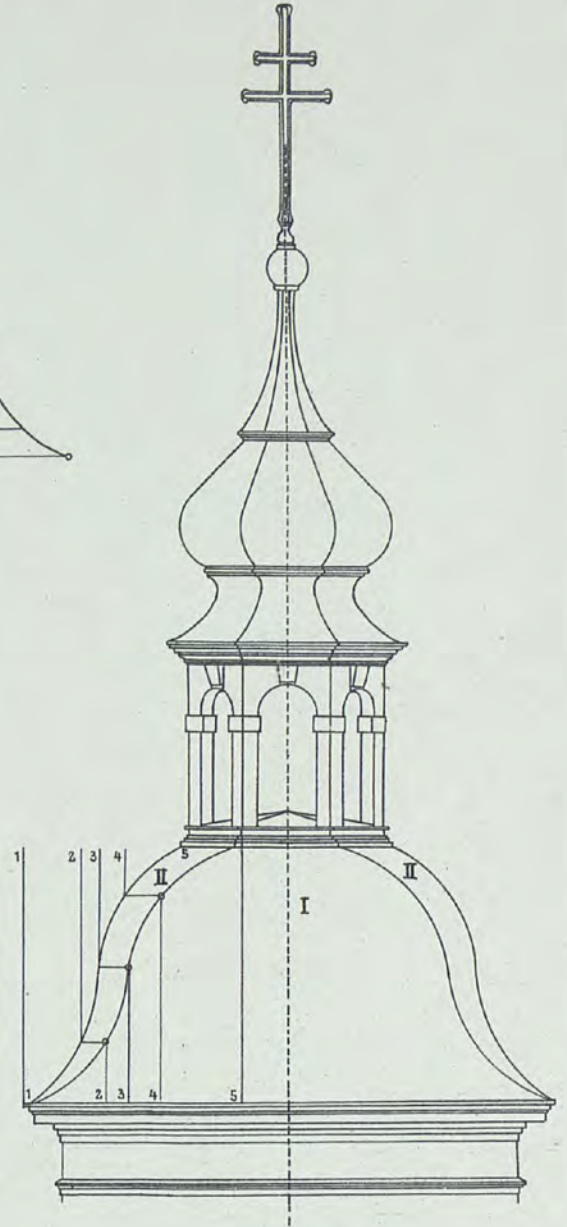
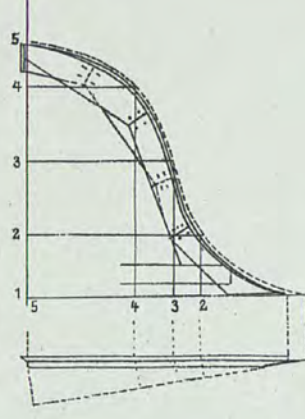
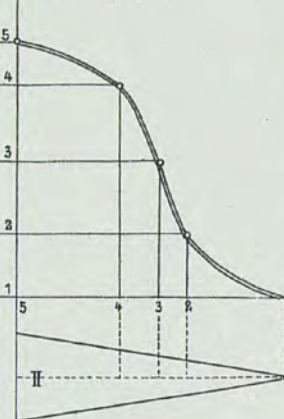

Werksatz der Kuppel

Ohne Sparren Mit Sparren

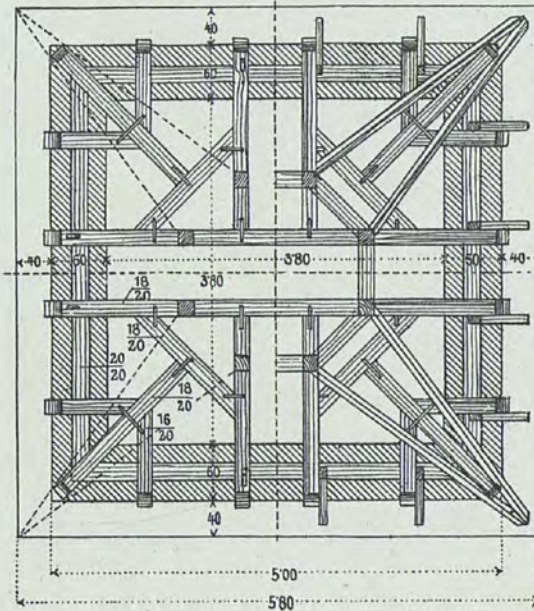

Draufsicht

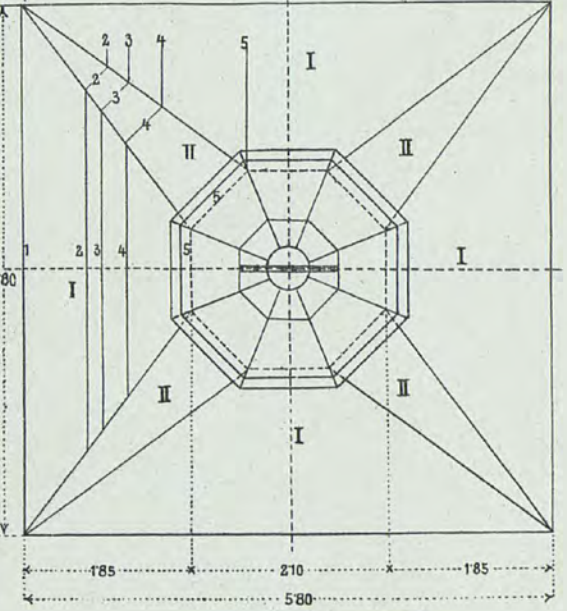

Grundriß der Glockenstube

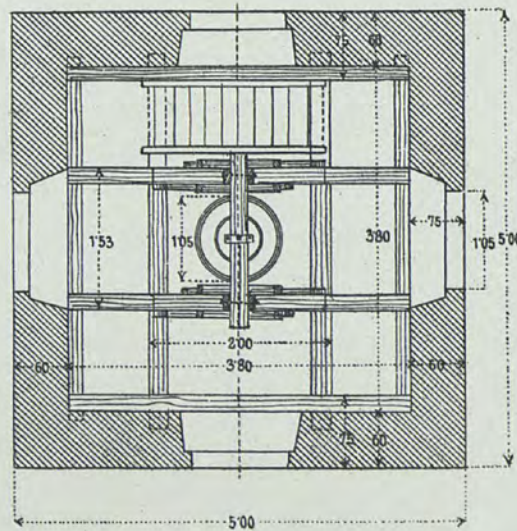

Grundriß

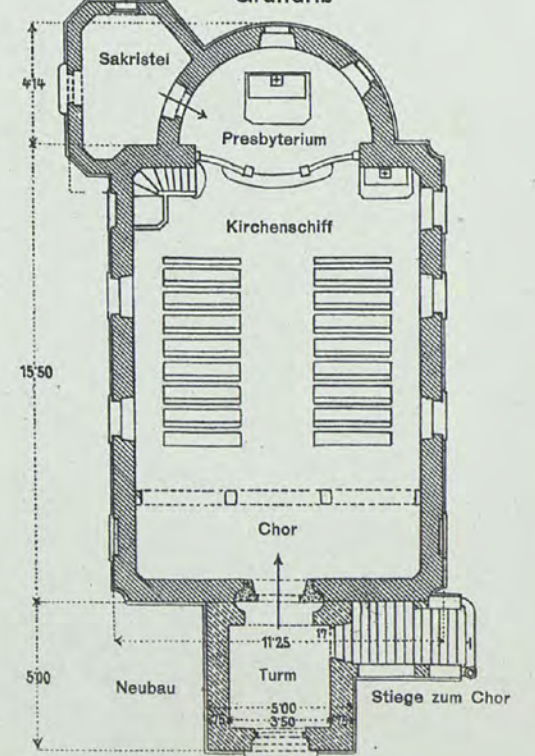

DER ZIMMERER-MEISTER, I. TEIL, Nr. 101
KUPPEL ÜBER EINEN QUADRATISCHEN KIRCHTURM

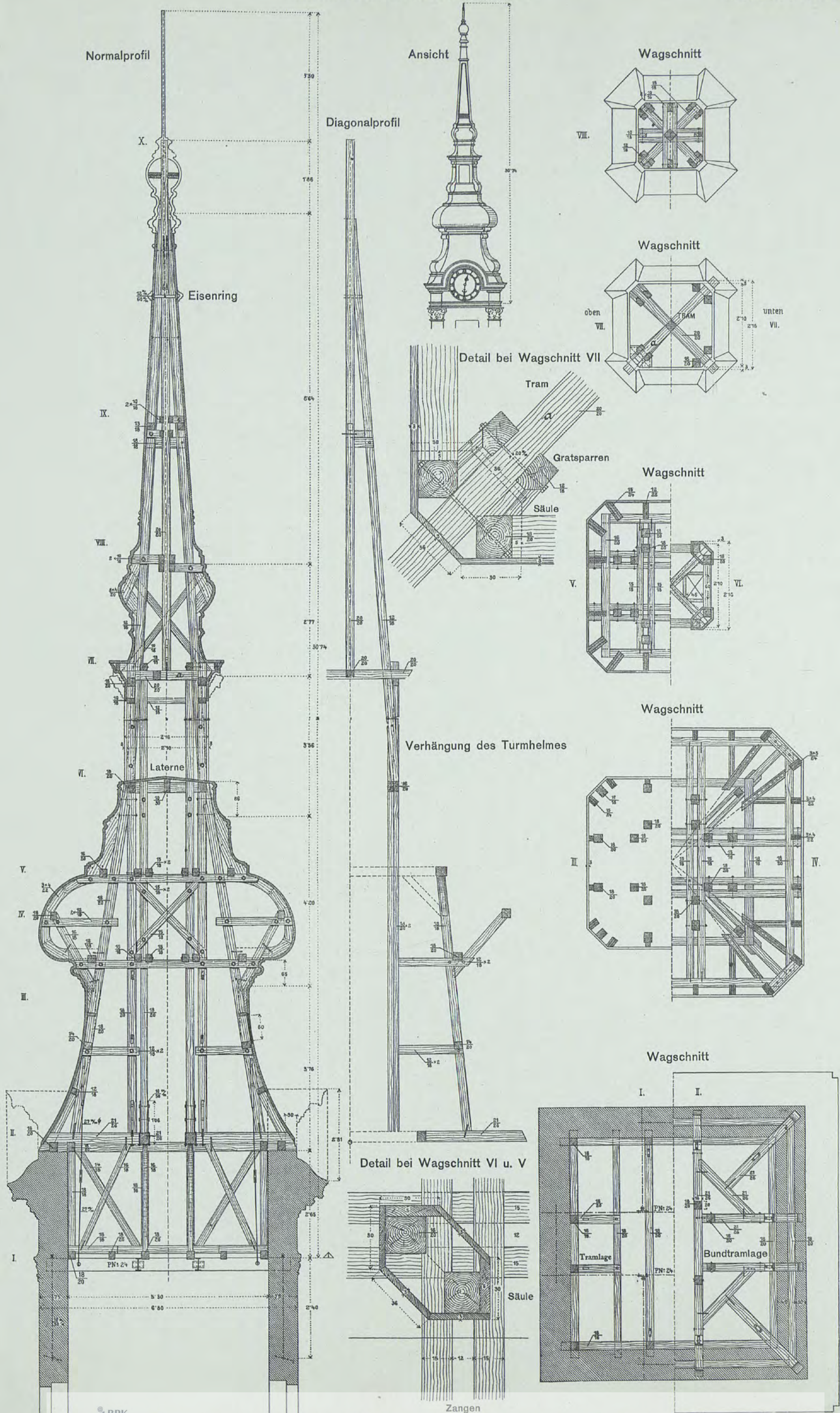

DER ZIMMERER-MEISTER, I. TEIL, Nr. 102
KUPPEL ÜBER EINEN KIRCHTURM