

NEUNZEHN TAFELN

ZU

L. HENZ

PRAKTISCHE ANLEITUNG ZUM ERDBAU

DRITTE AUFLAGE

UMGEARBEITET UND VERMEHRT

VON

W. STRECKERT

Inventar. sub Litt. D. I. 134^a

BERLIN

VERLAG VON ERNST & KORN

(GROPIUS'SCHE BUCH- UND KUNSTHANDLUNG)

1874.

XXX
973

NIVELLEMENTS - UND SITUATIONSPLAN Kilometer VI⁺⁵ bis VII⁺³.

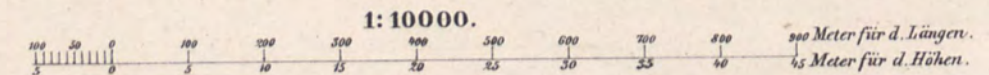
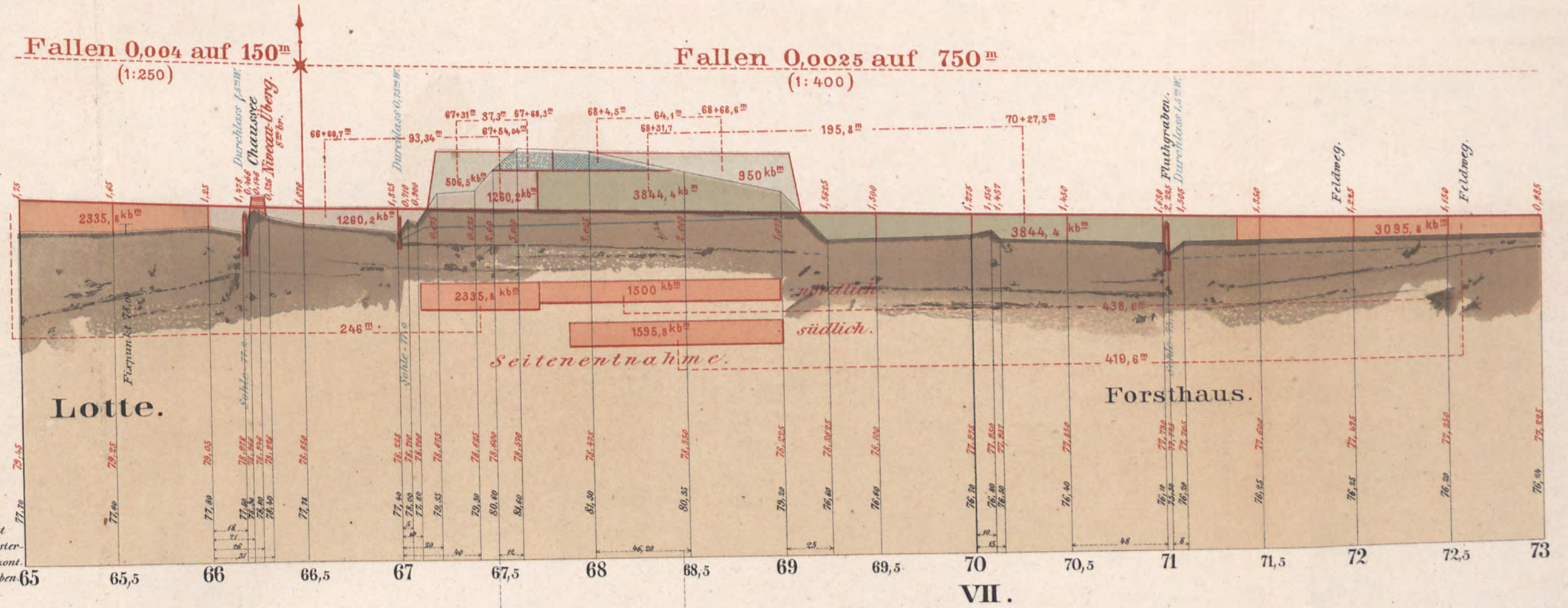
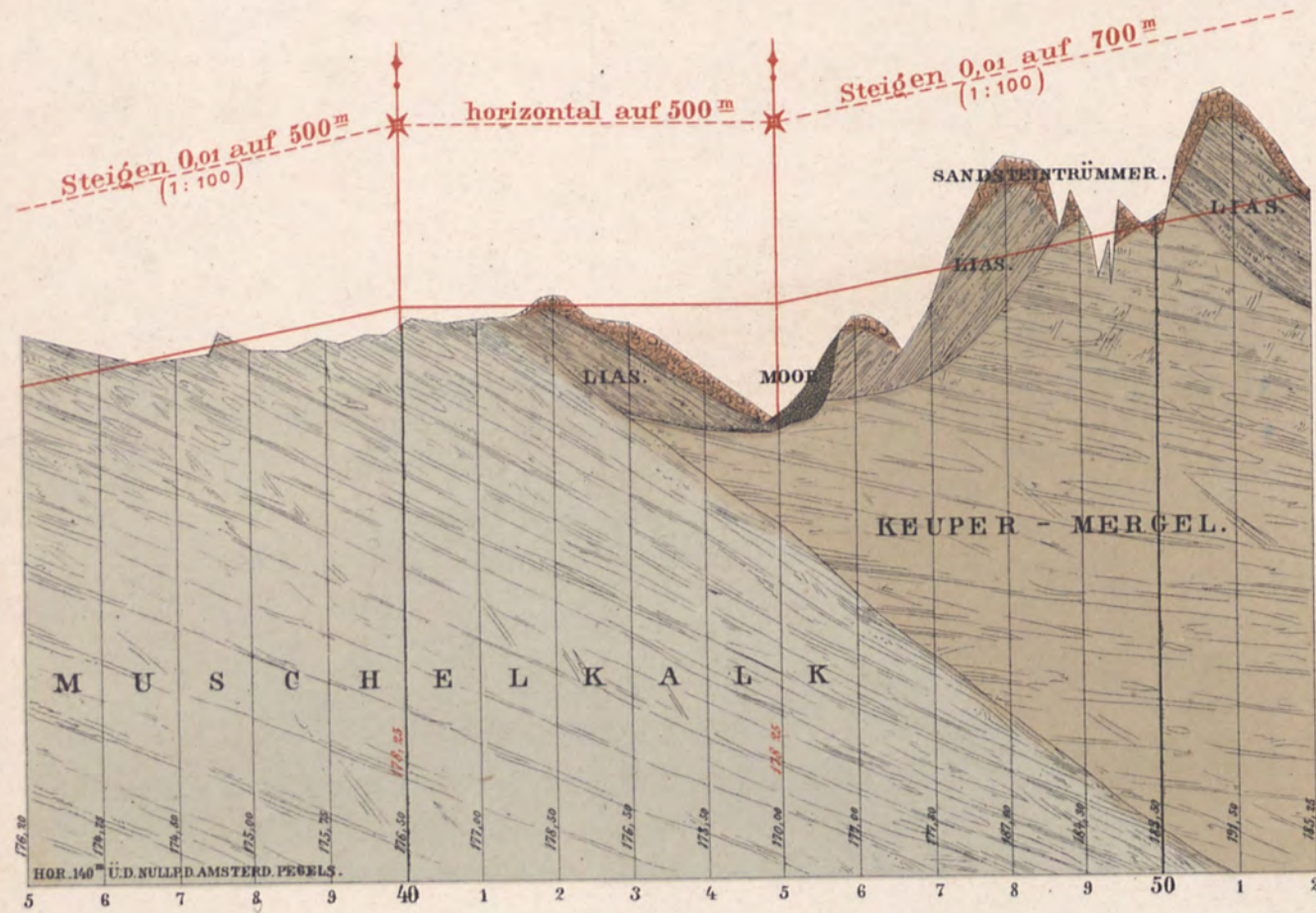

gerade Linie 346,20^m lang
Curve 453,8^m lang, Radius 1500^m
0,9 Mln.

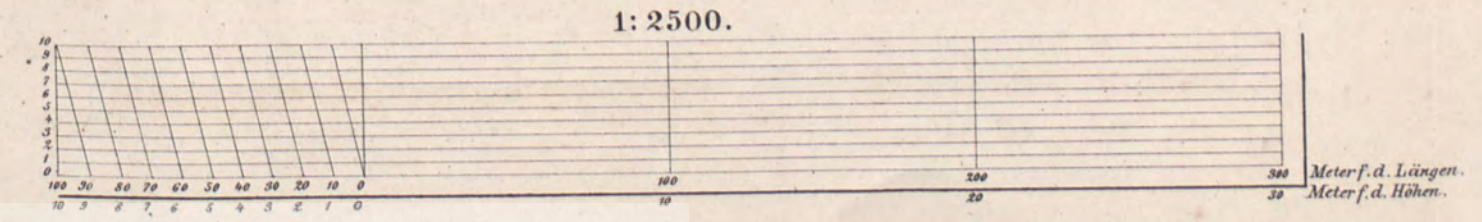
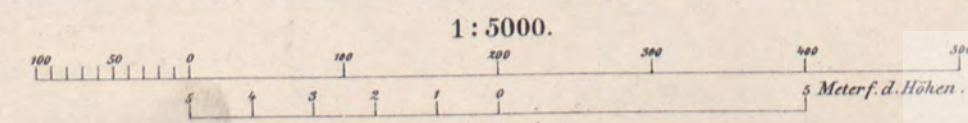
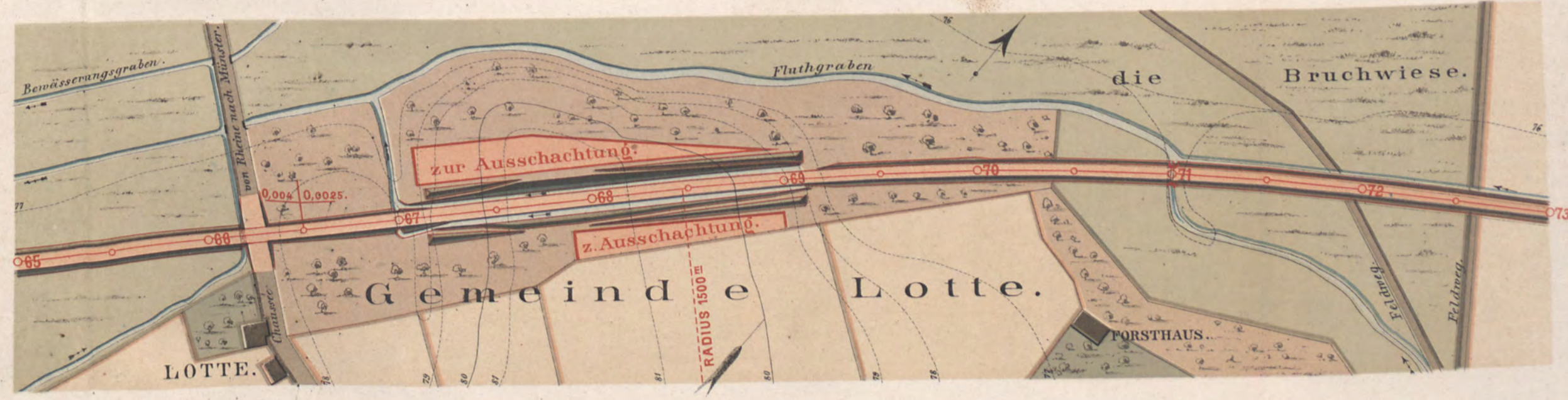
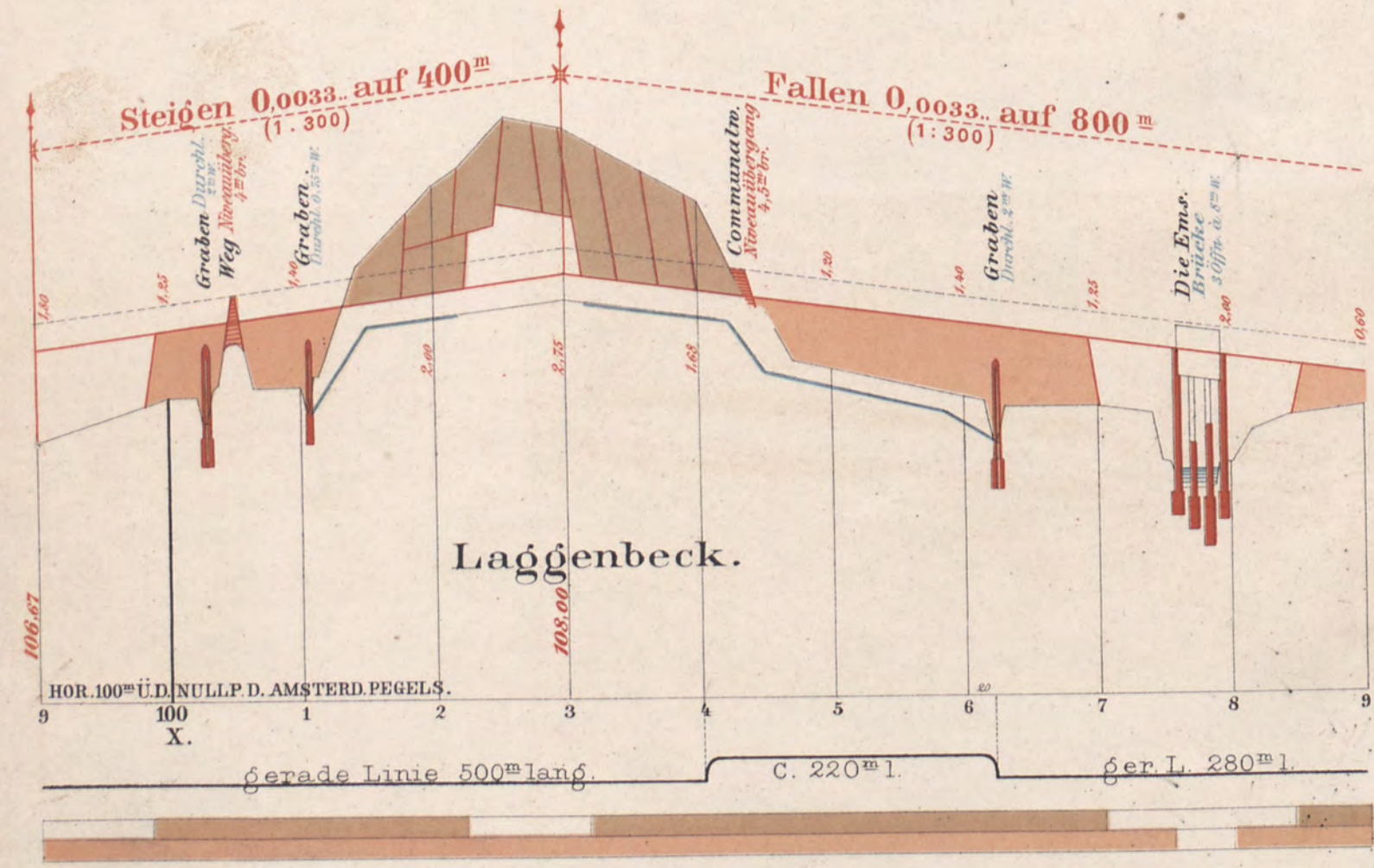

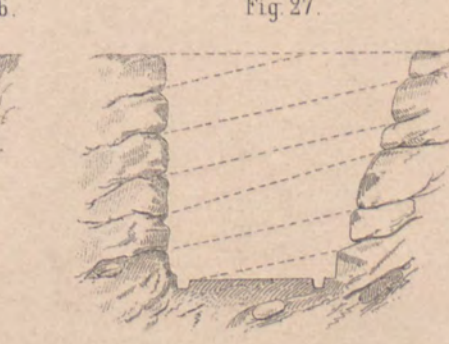
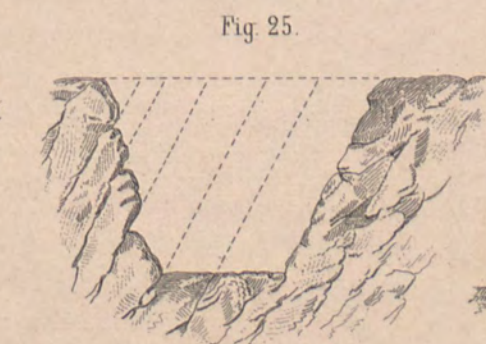
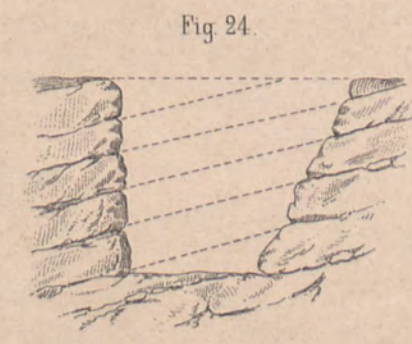
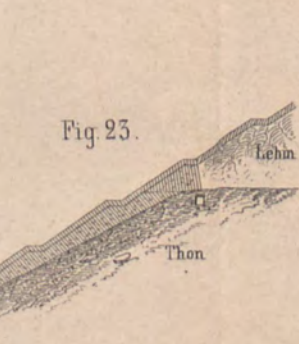
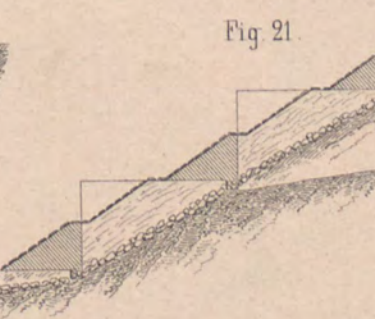
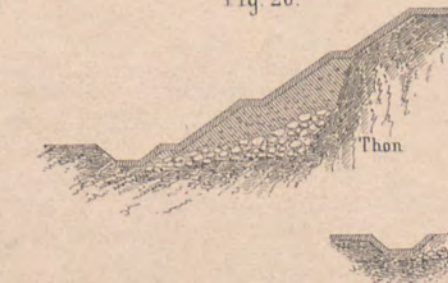
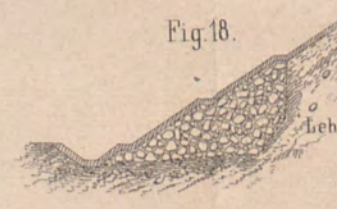
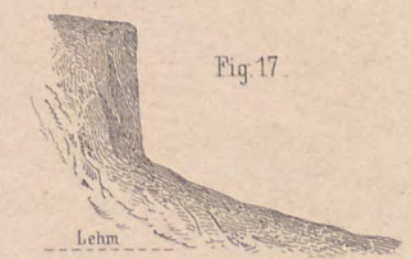
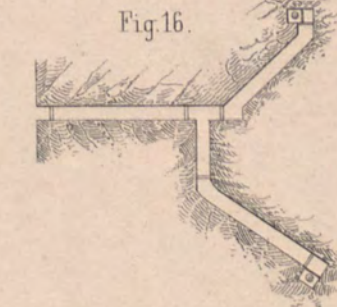
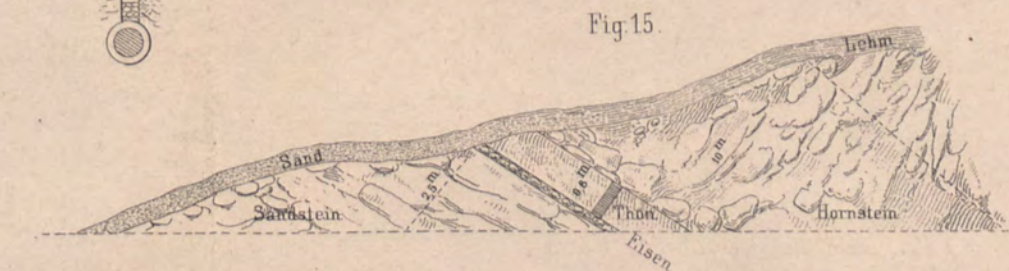
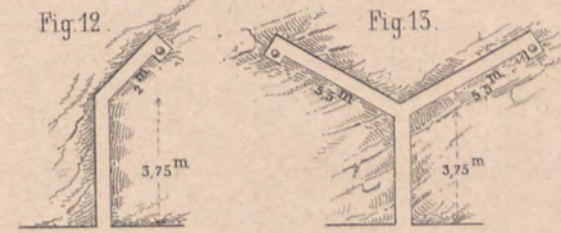
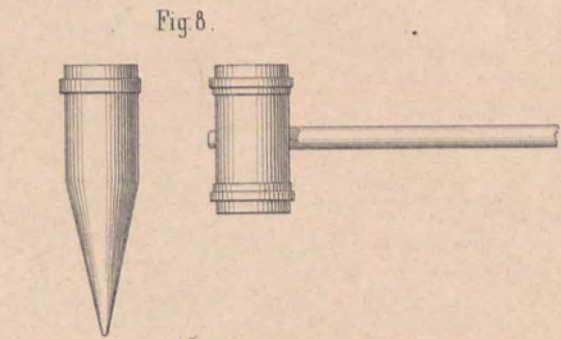
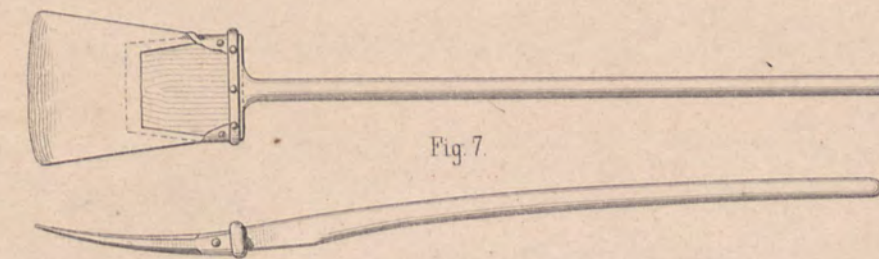
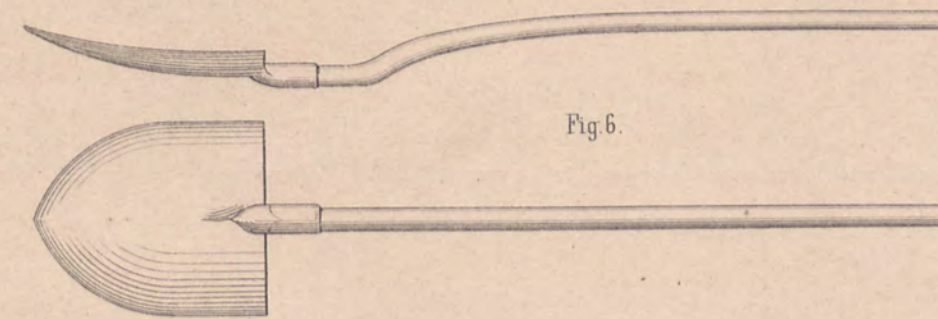
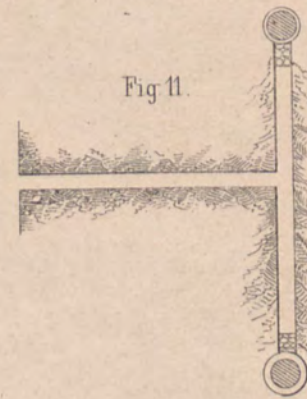
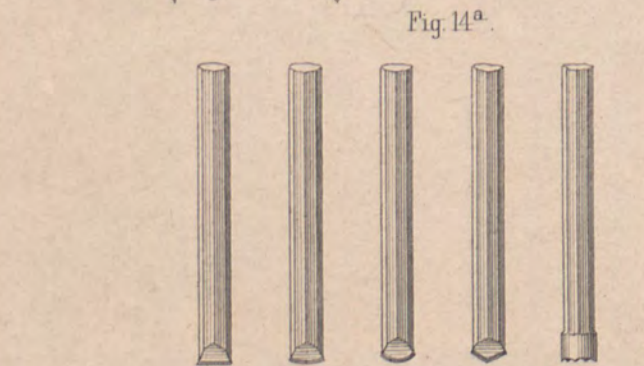
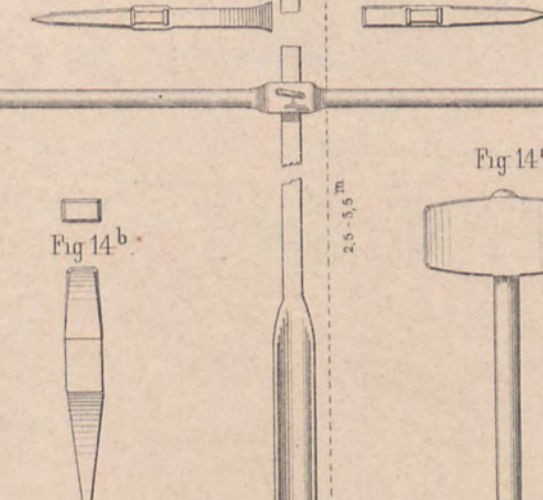
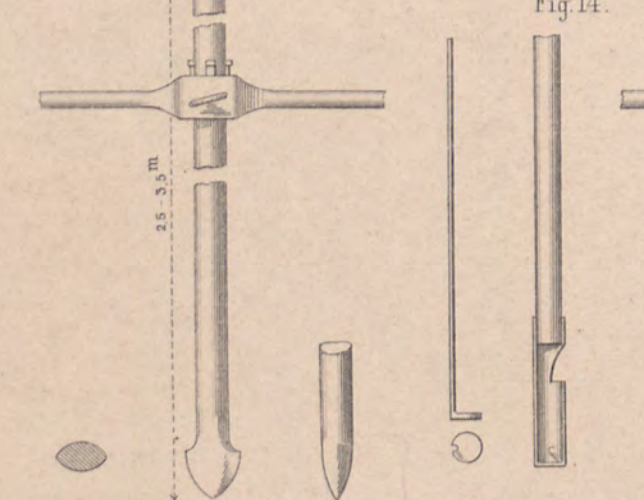
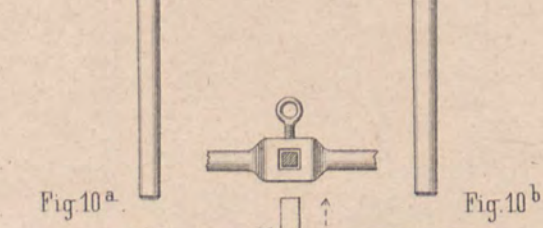
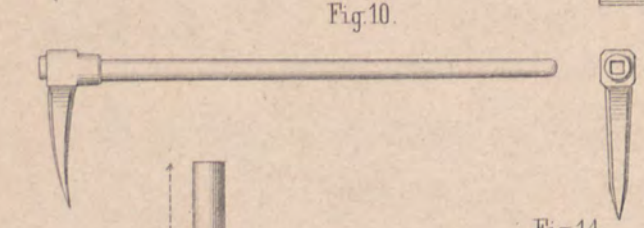
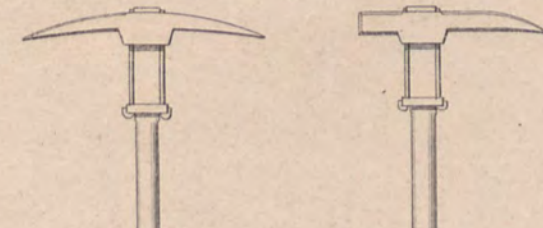
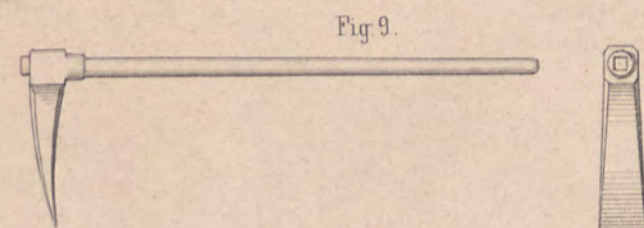
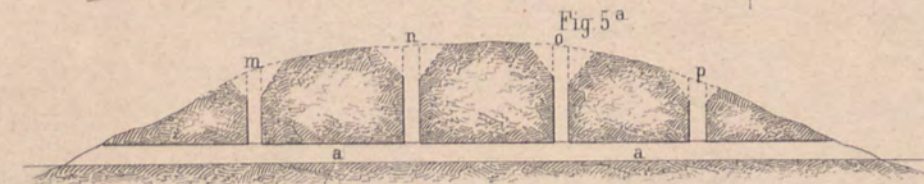
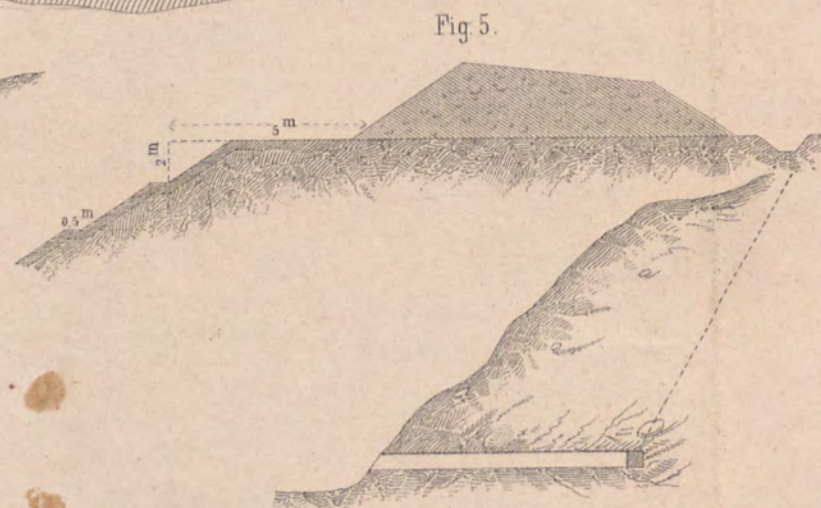
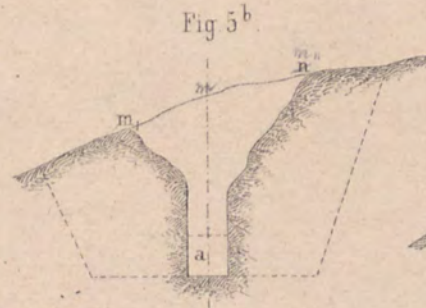
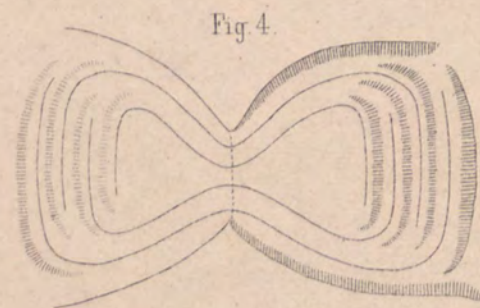
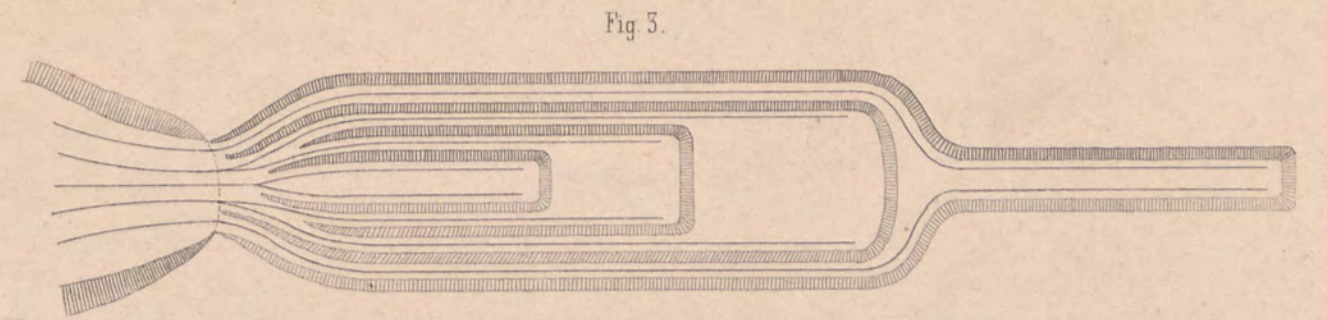
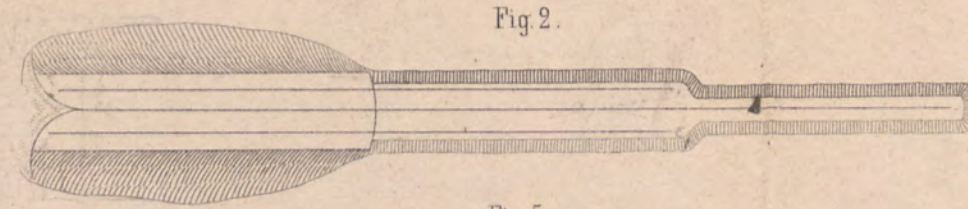
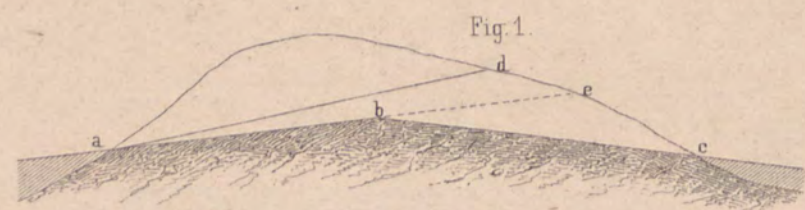

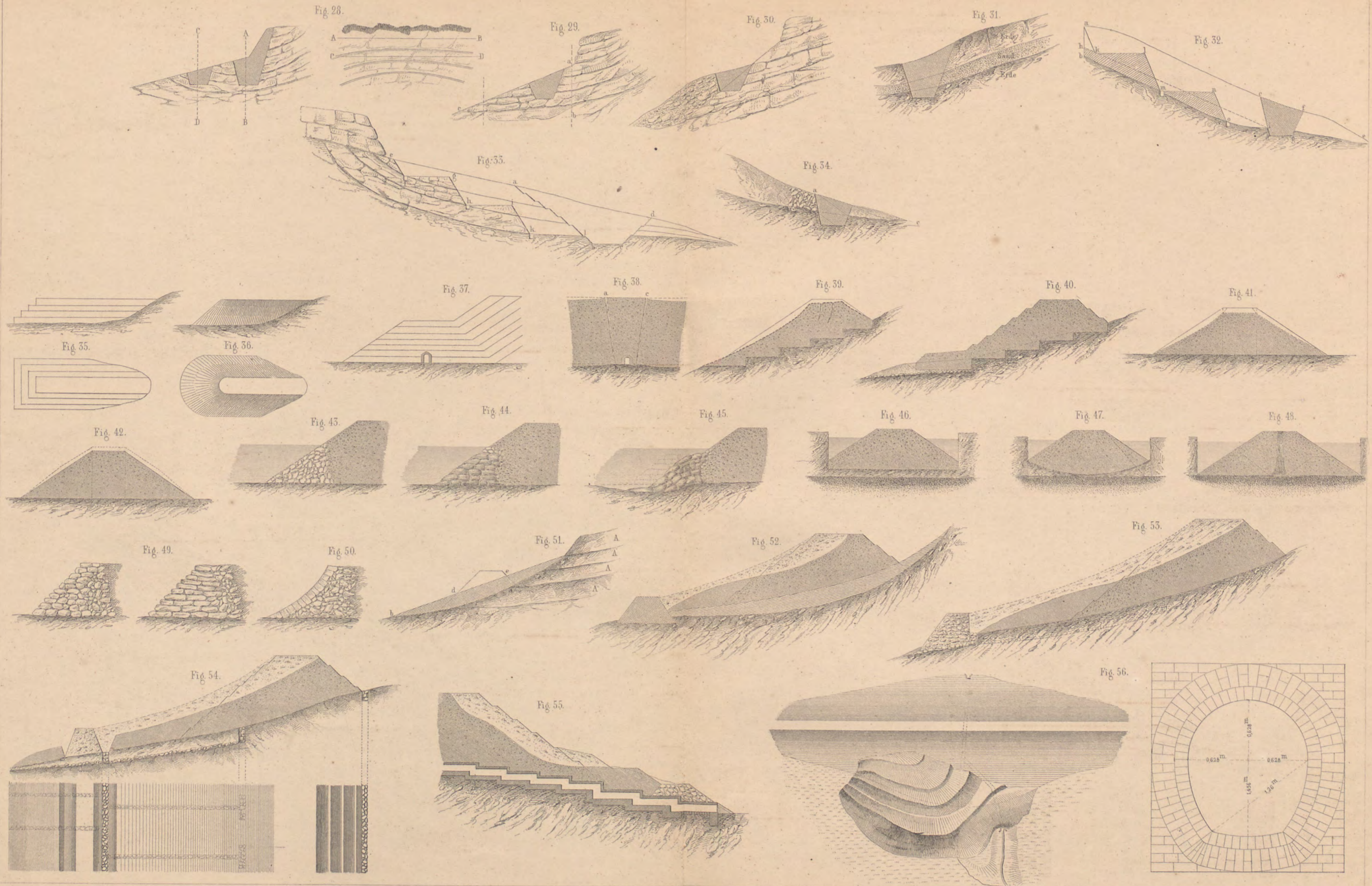

Verlag von Ernst & Korn in Berlin.

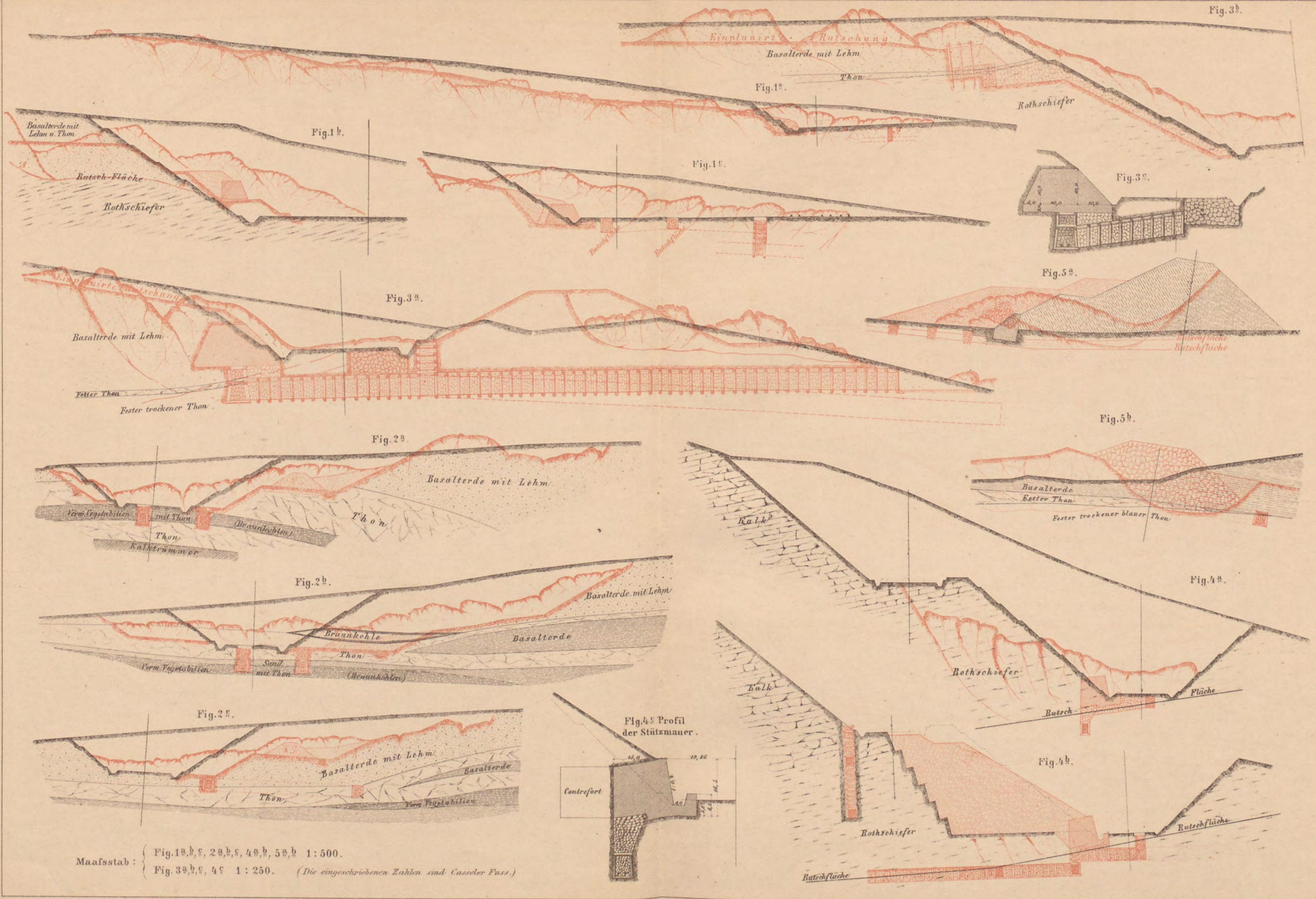

Maafsstab: { Fig. 1^a, b, c, 2^a, b, c, 4^a, b, 5^a, b 1:500.
 Fig. 3^a, b, c, 4^c 1:250. (Die eingeschriebenen Zahlen sind Casseler Fuss.)

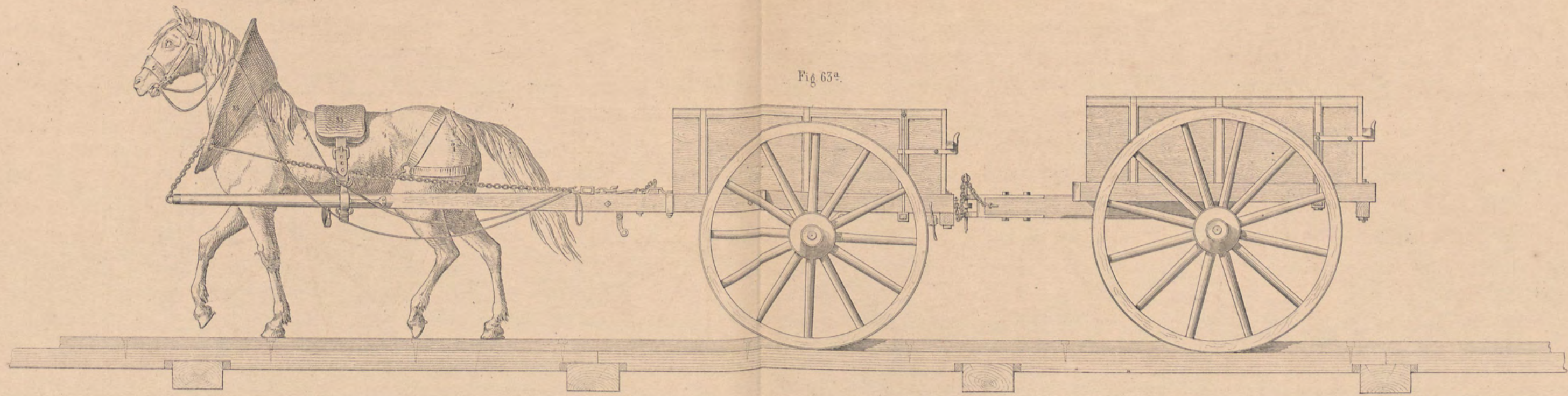

Fig 63a.

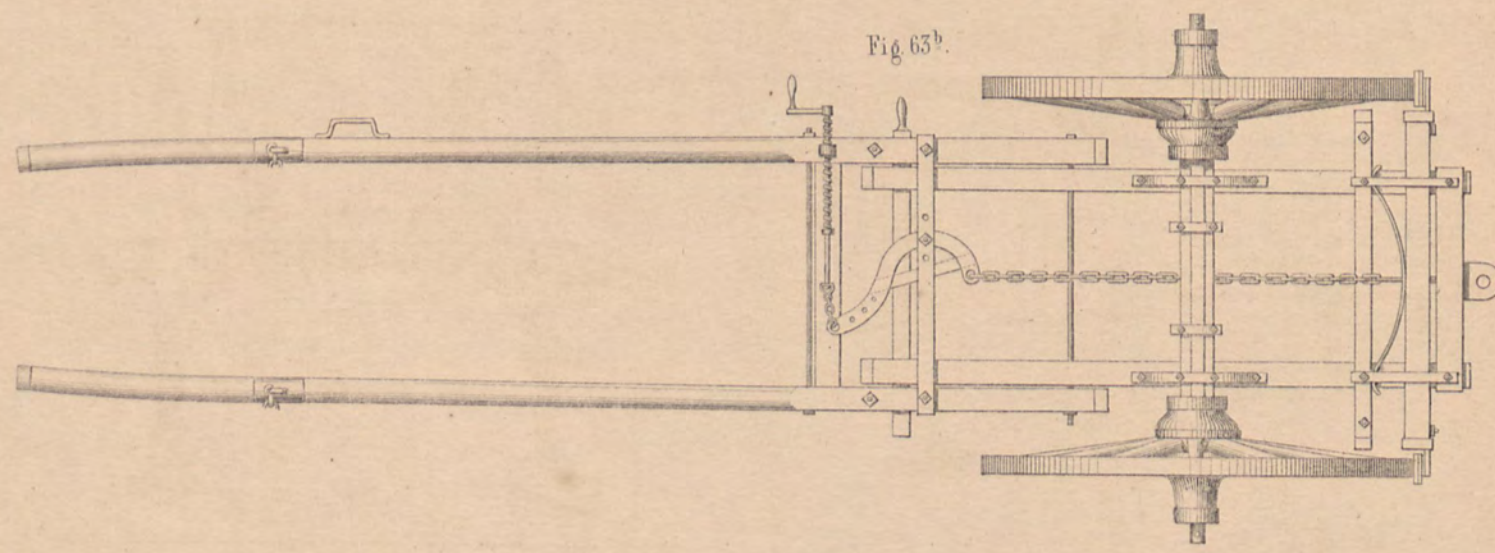

Fig 63b.

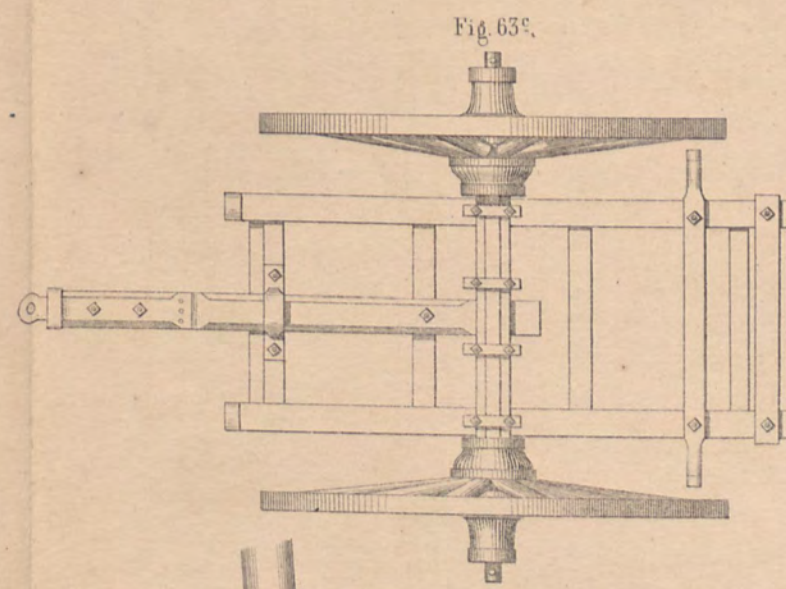

Fig 63c.

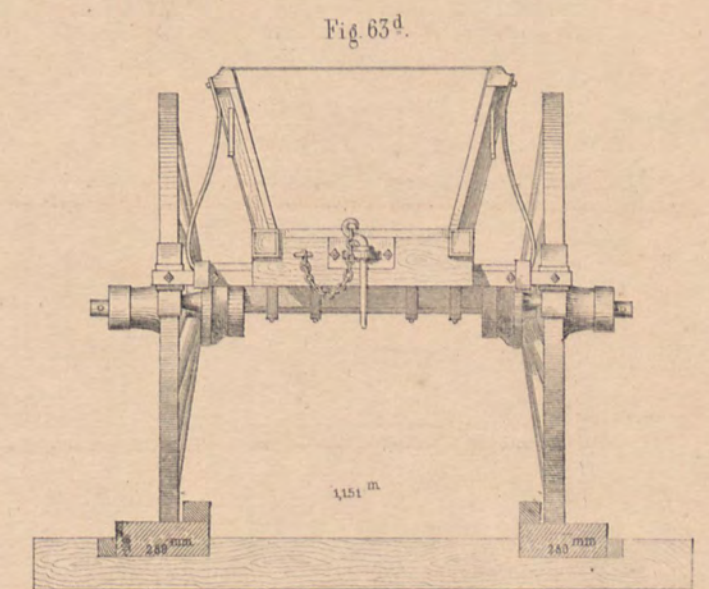

Fig 63d.

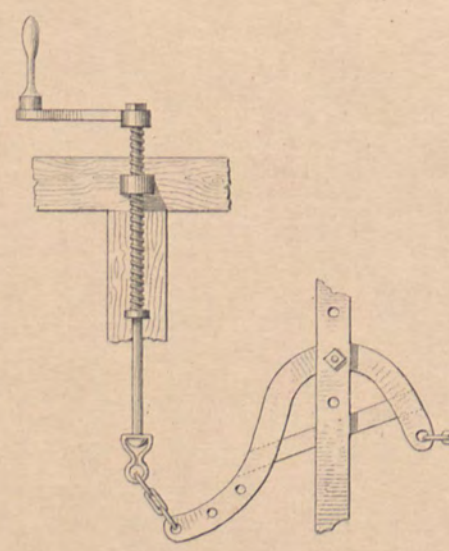

Fig 63e.

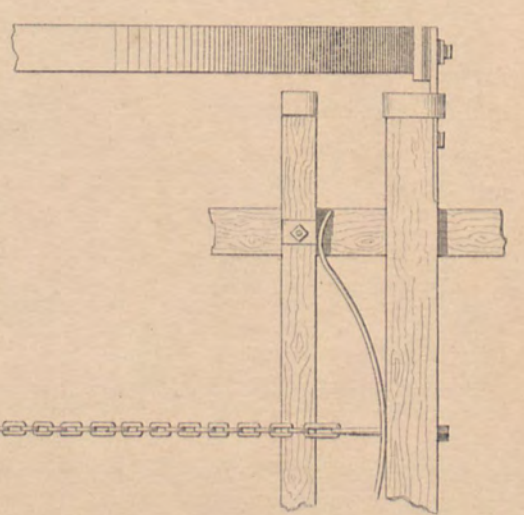

Fig 64.

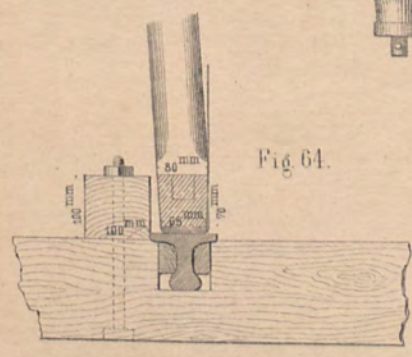

Fig 65.

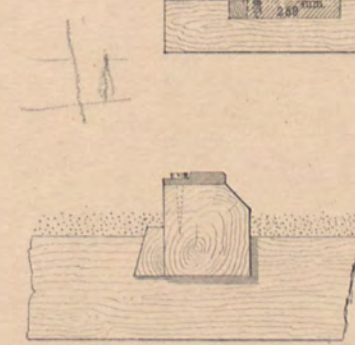
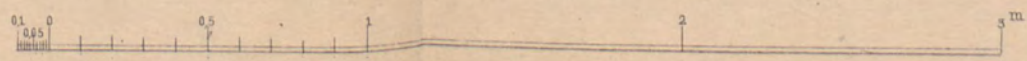
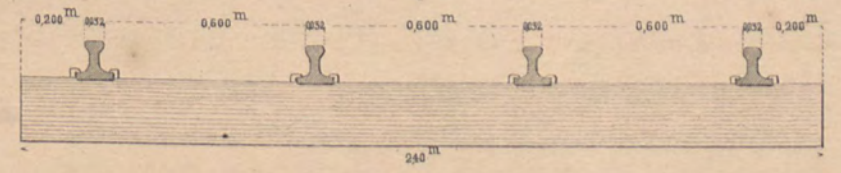

Fig 66.



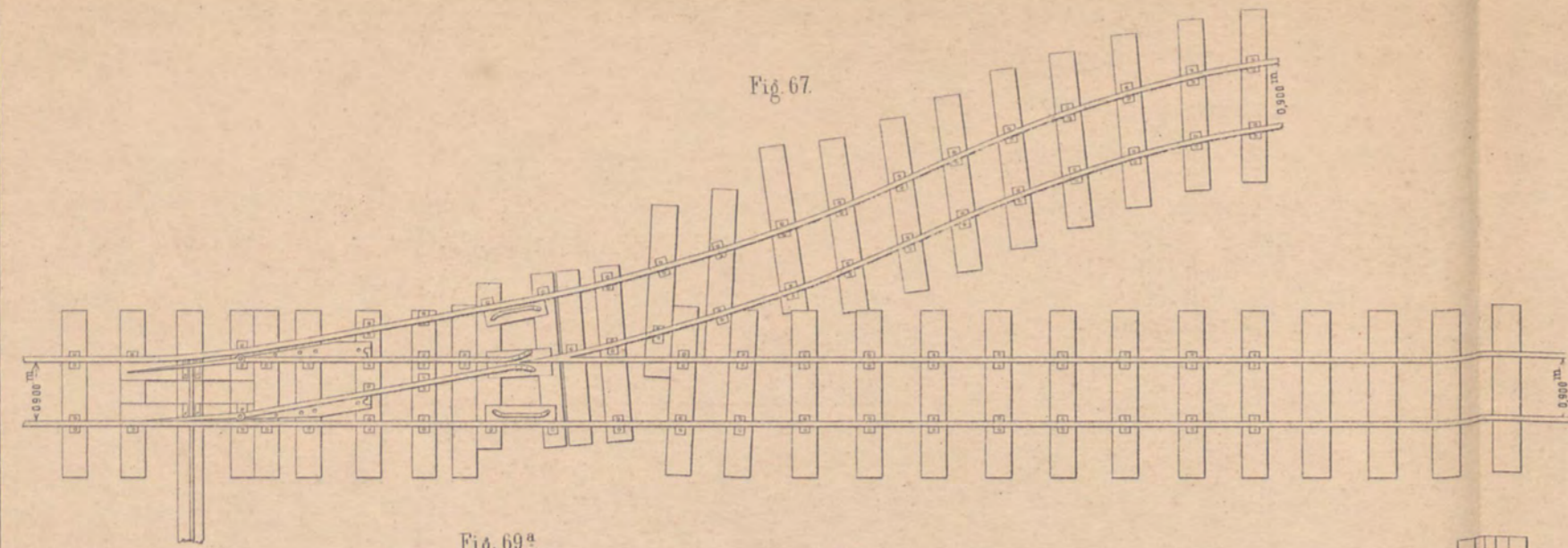

Fig. 67.

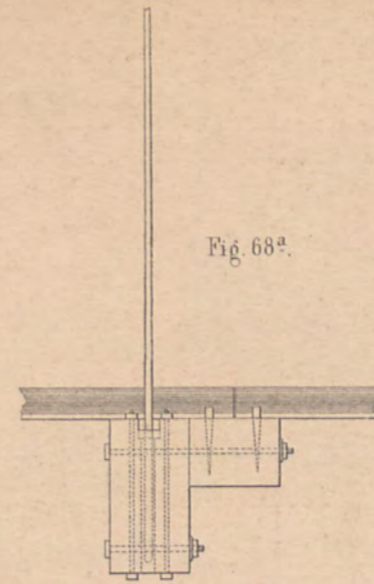

Fig. 68a.

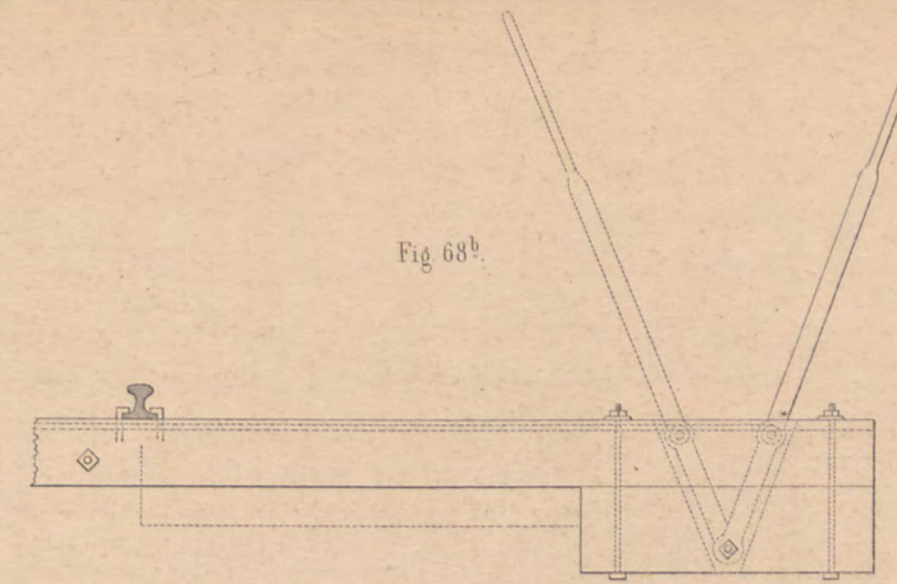

Fig. 68b.

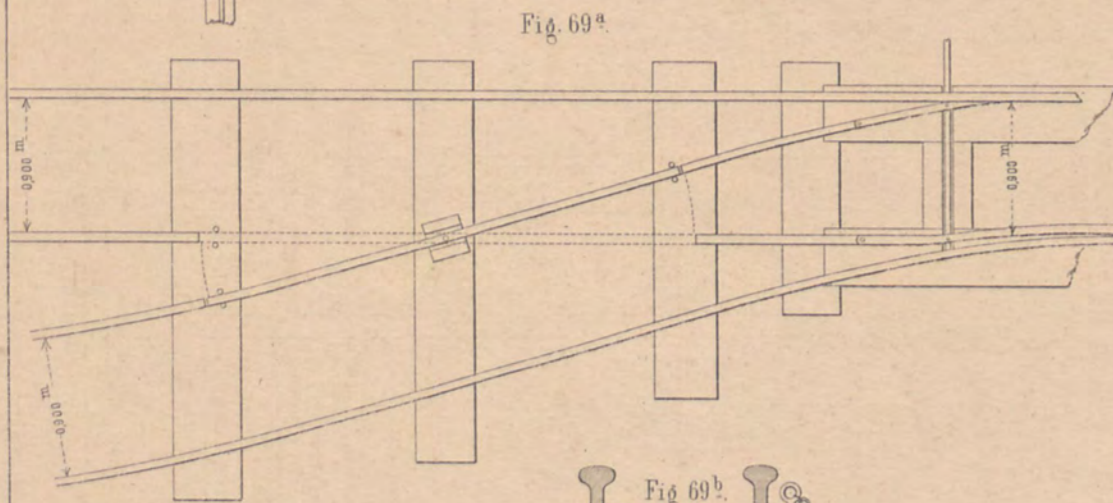

Fig. 69a.

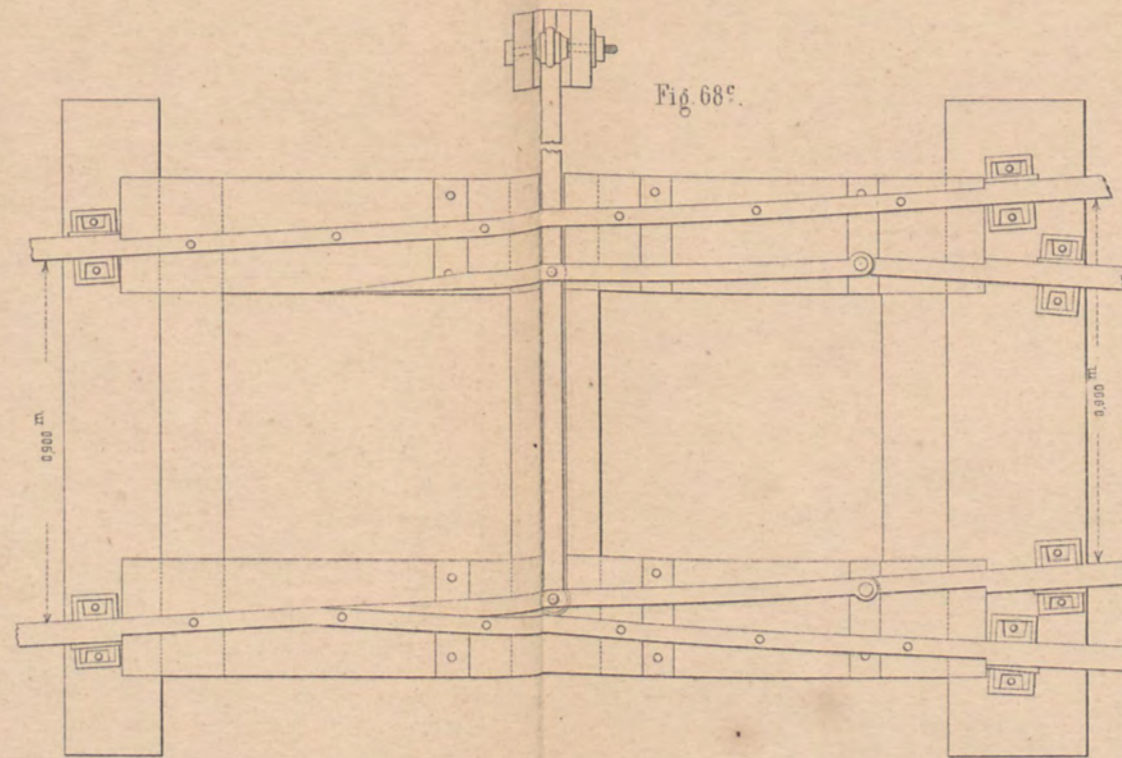

Fig. 68c.

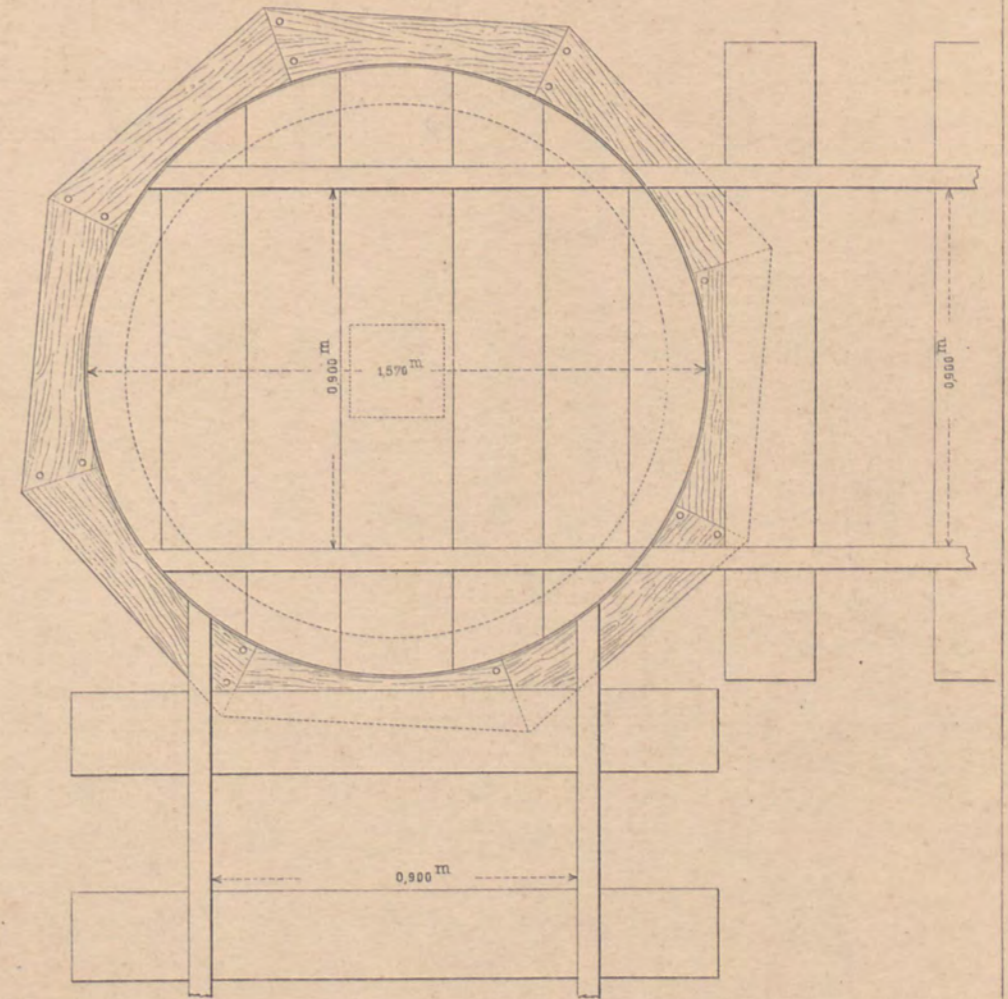

Fig. 70.

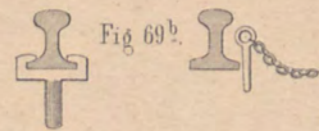

Fig. 69b.

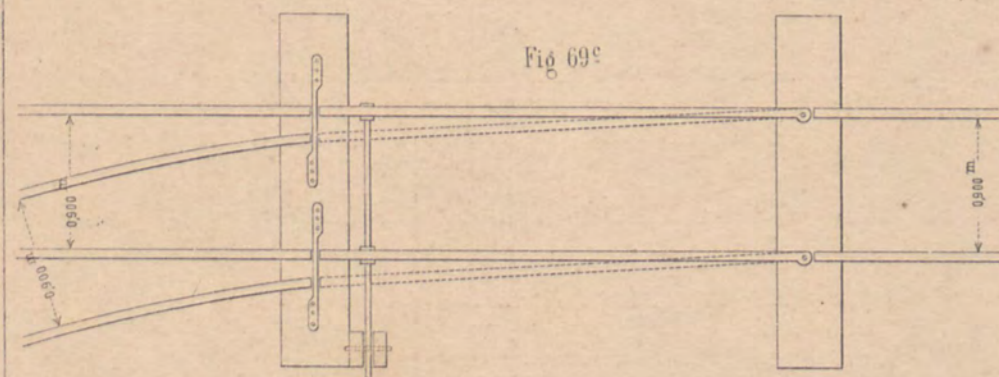

Fig. 69c.

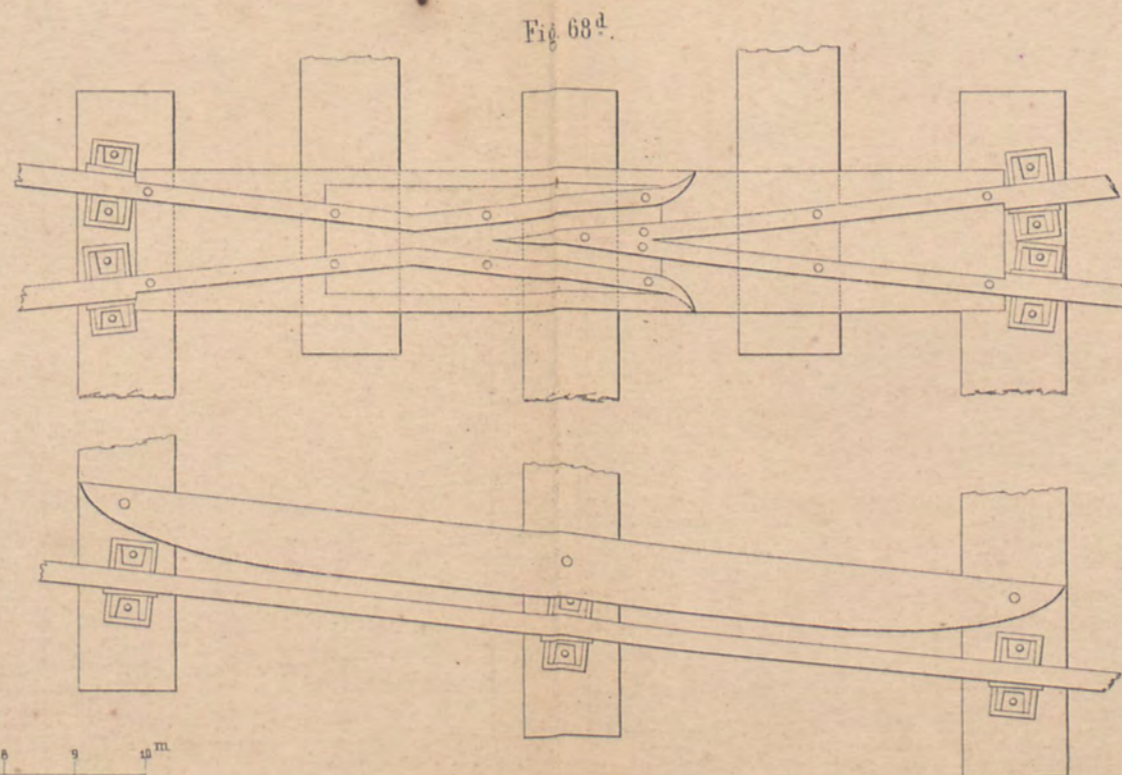

Fig. 68d.

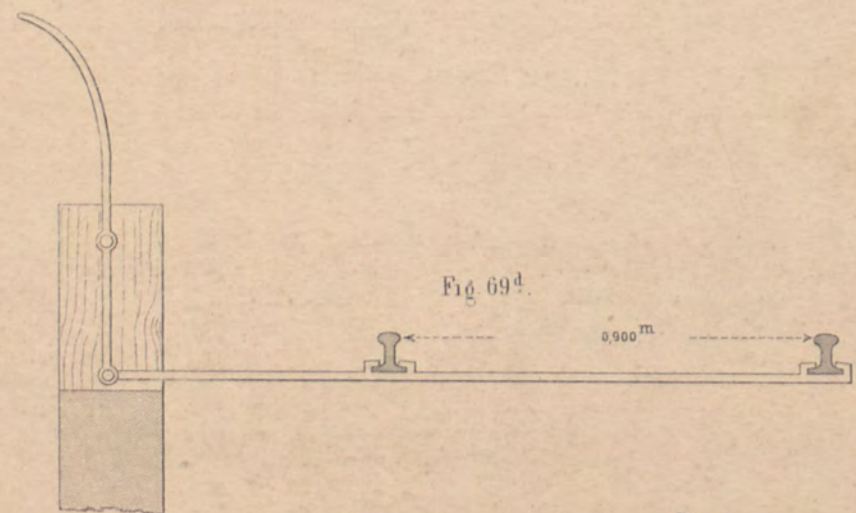
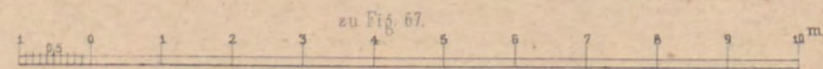
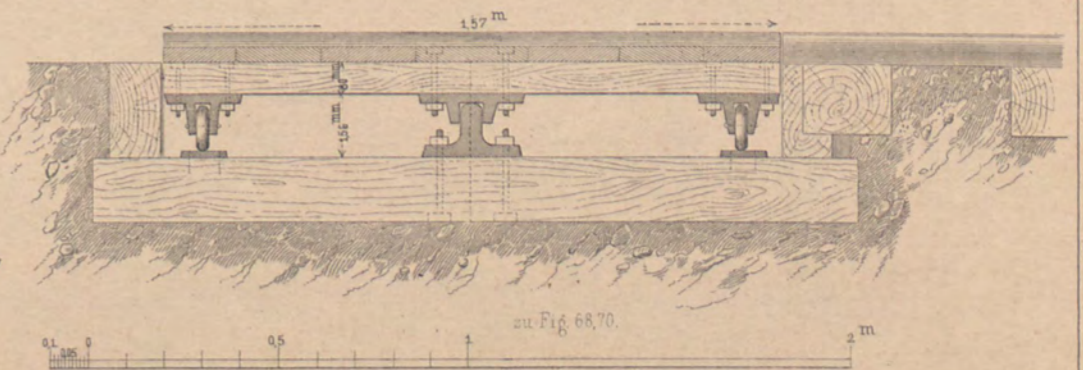

Fig. 69d.



zu Fig. 67.



zu Fig. 68, 70.

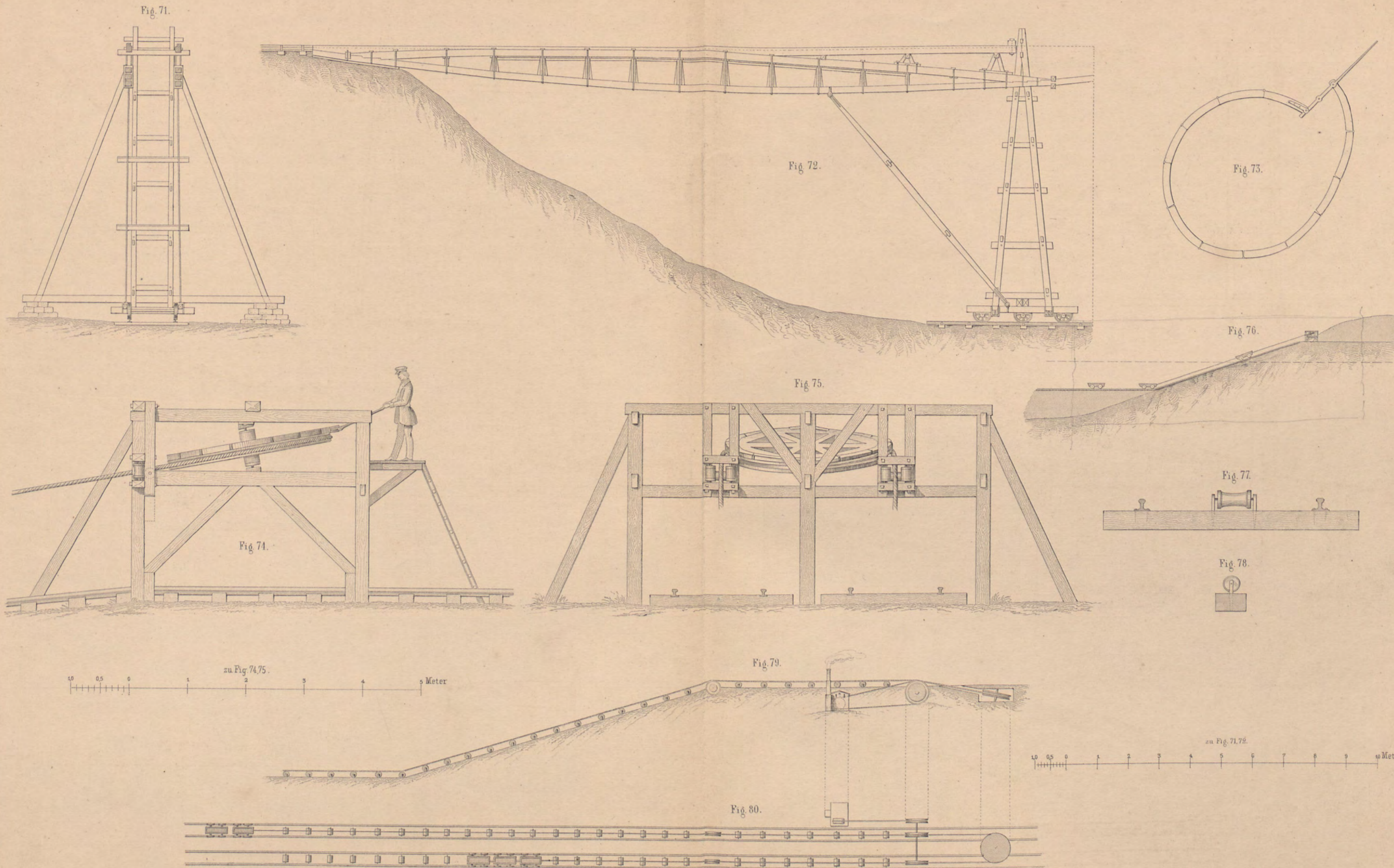

*Oben Anfang
halten sich
nicht genau
flauer*

zu Fig. 74, 75.
0 0.5 1 2 3 4 5 Meter

zu Fig. 71, 78.
0 0.5 1 2 3 4 5 6 7 8 9 10 Meter

Fig 81.

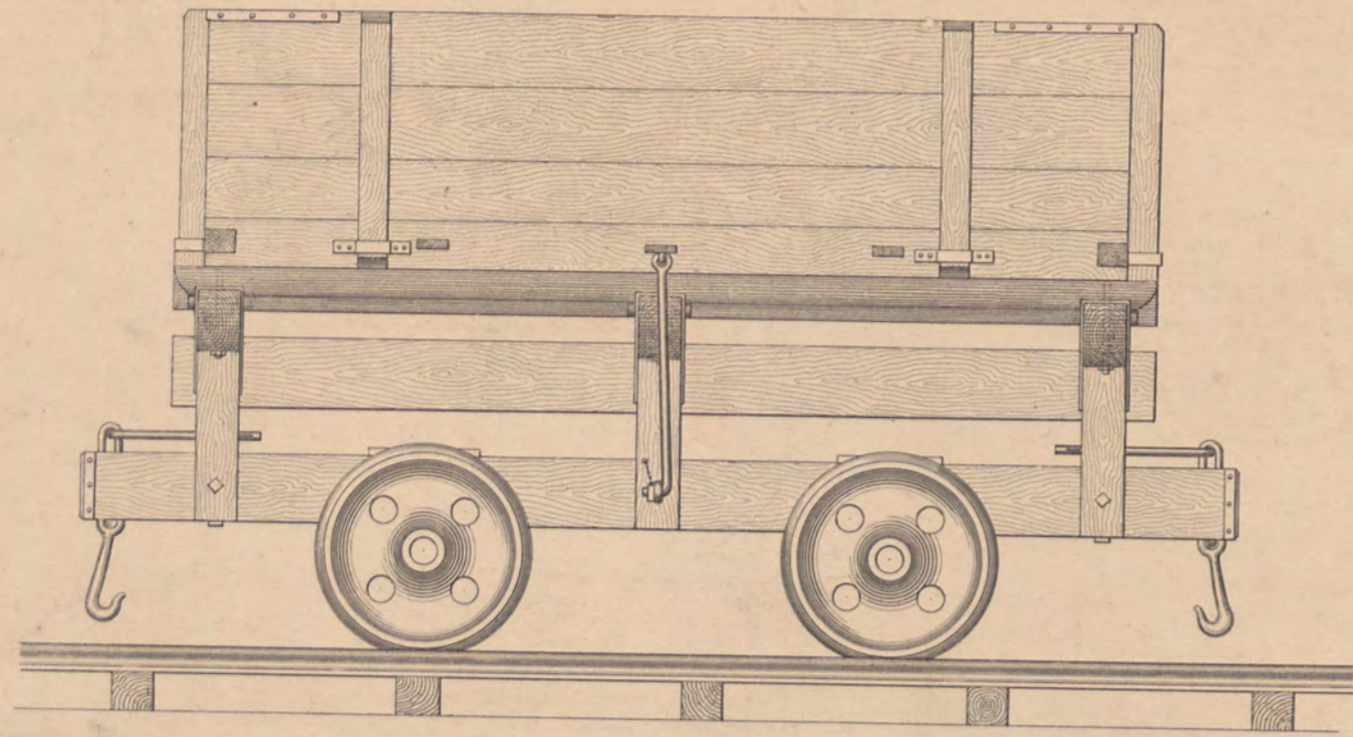
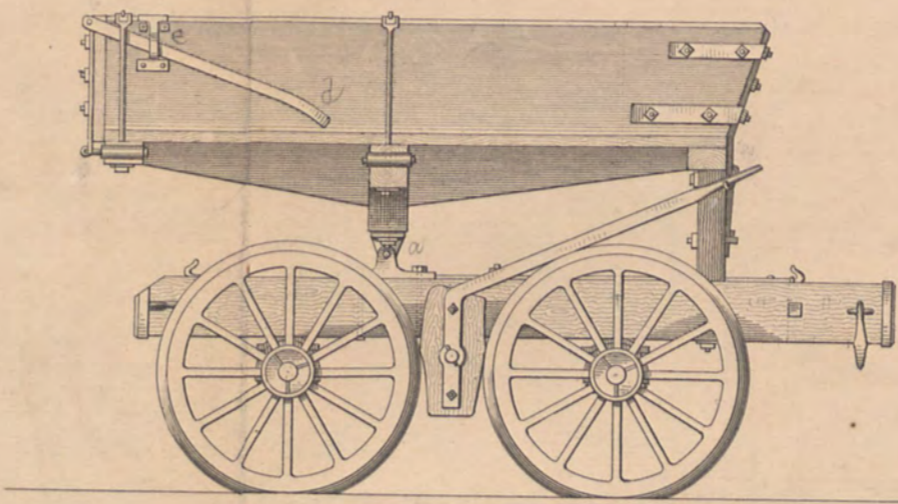

Fig 83.



Vorkipper von der Westphal Eisenbahn.

Fig 84.

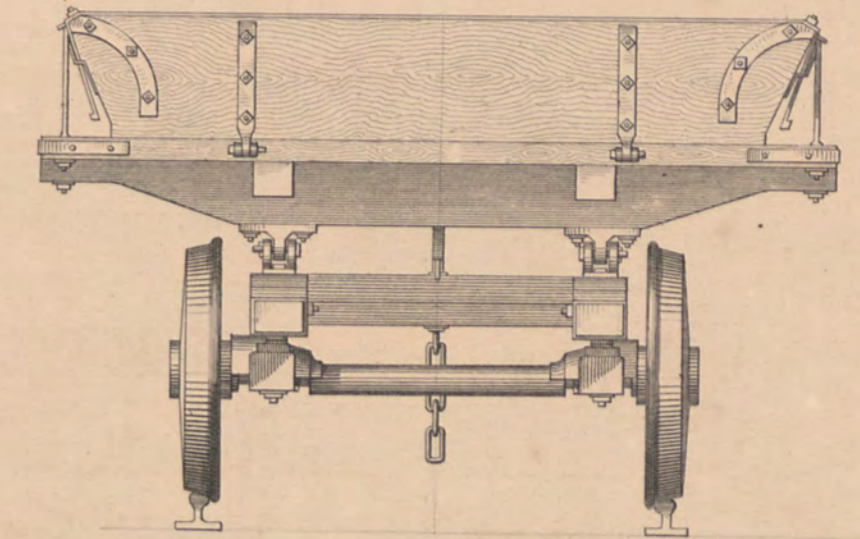
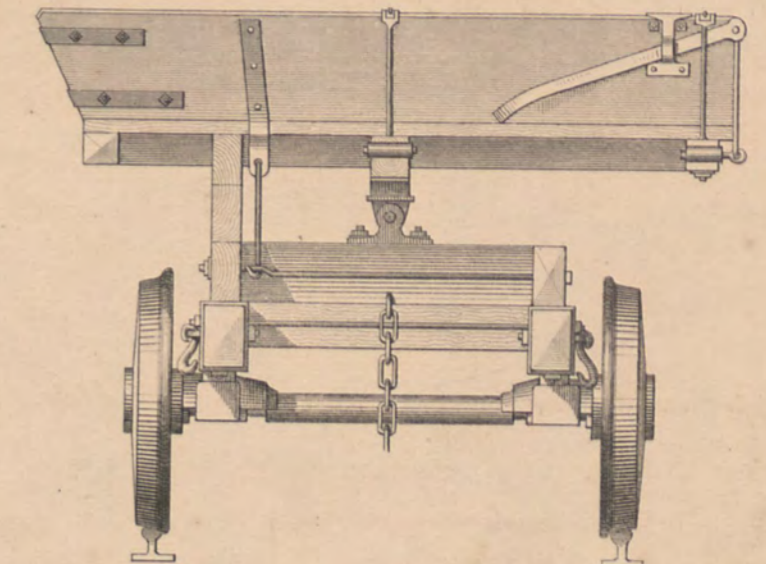
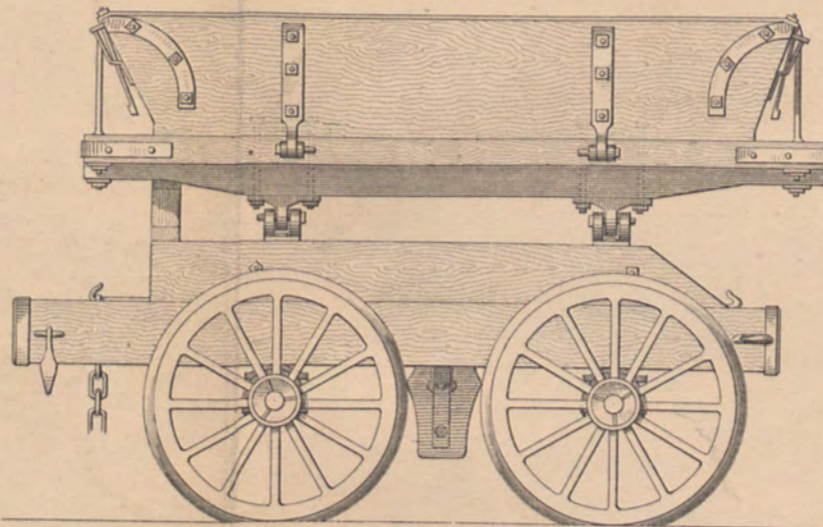

Fig 85.

Seitenkipper von Dortmund-Soest.

Fig 86.



Seiten-Kipper der Vorpommerschen Bahnen (Bau-Unt Steinfeld)

1,78 kb^m Inhalt

Fig 82.

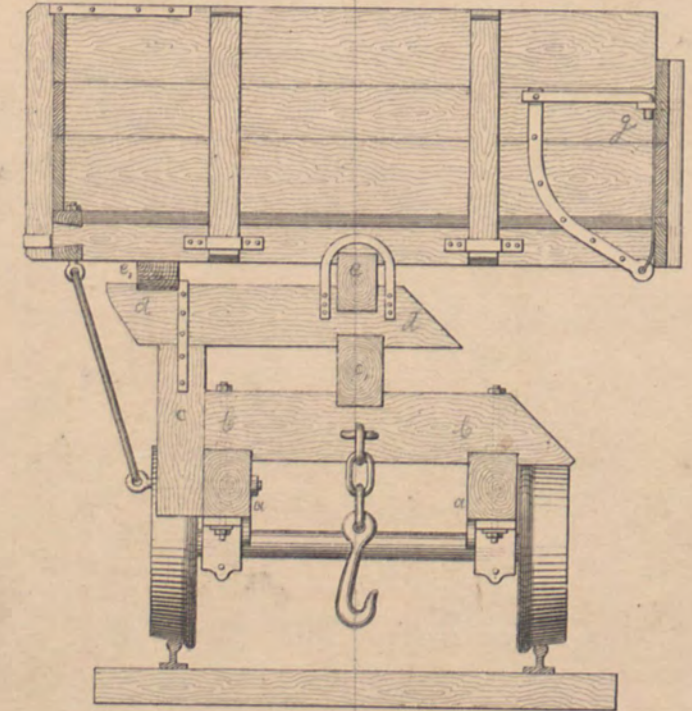

Seiten-Kipper der Nordhausen Erfurter Eisenbahn (Baumeister Meske)

1,5 kb^m Inhalt

Fig 88.

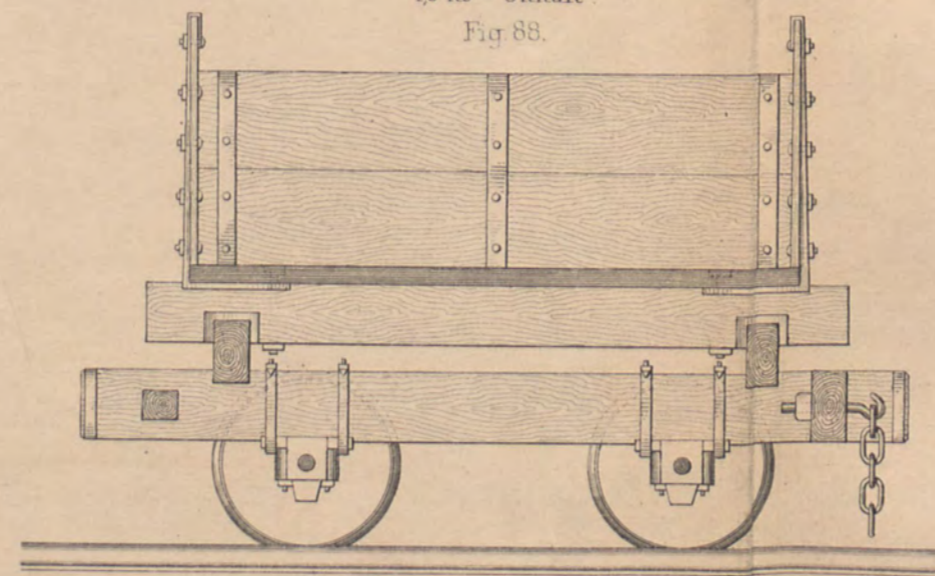
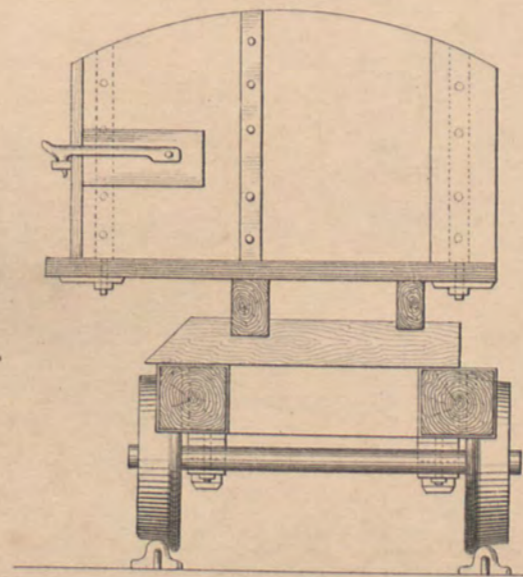
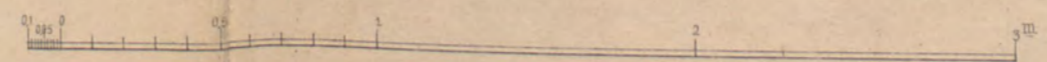
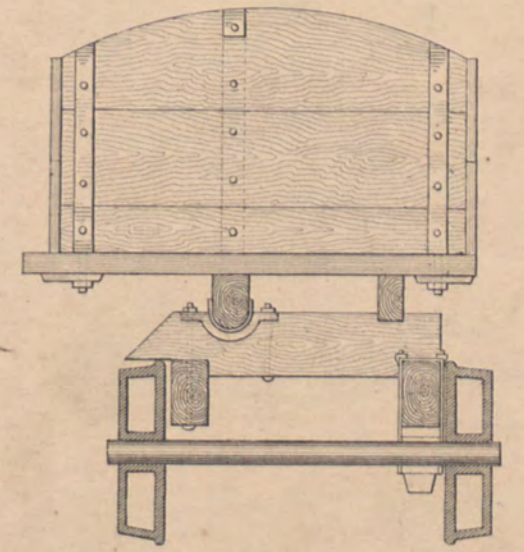

Fig 89^a



89^b



Verlag von Ernst & Korn in Berlin.

Kadedler gest.



Untergestell eines grossen Seiten-Kippers 4,45^{km} Inhalt (Baumeister Meske).

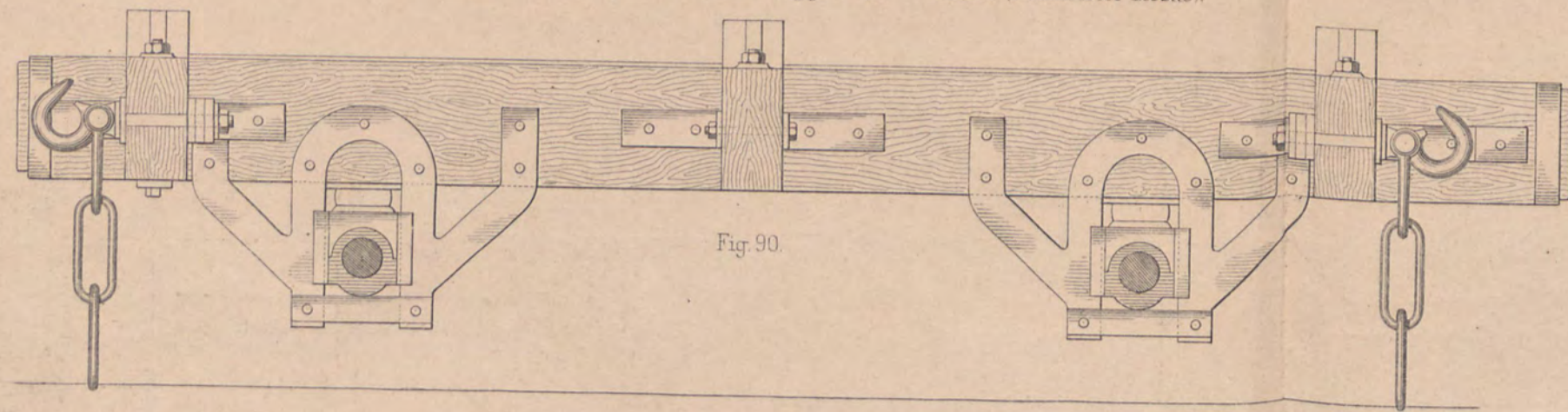

Fig. 90.

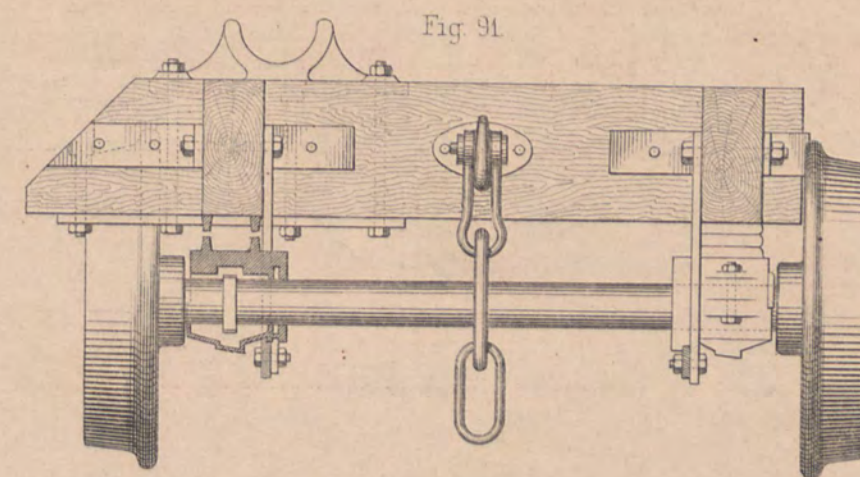
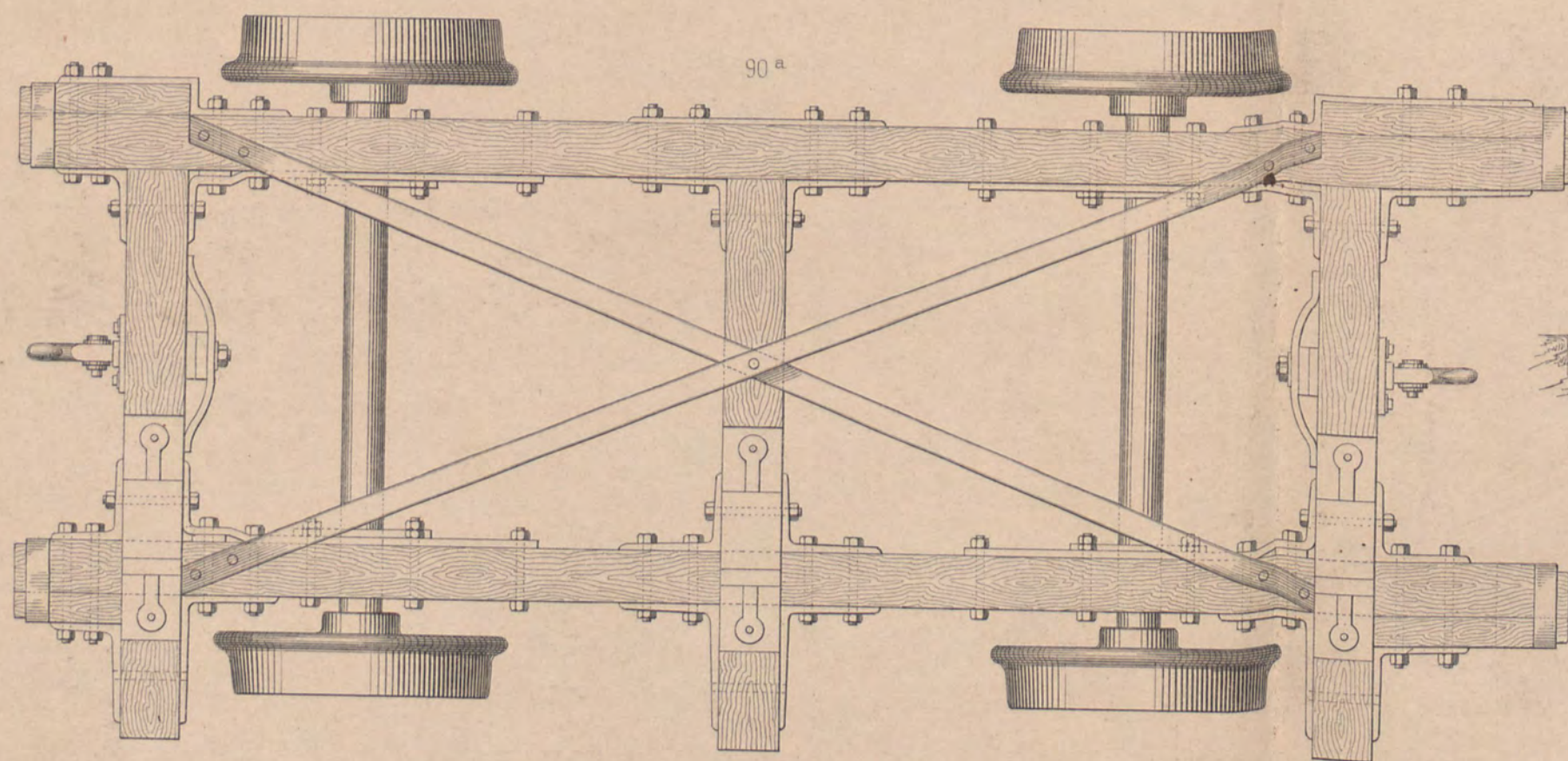

Fig. 91.



90^a

Fig. 93^a.

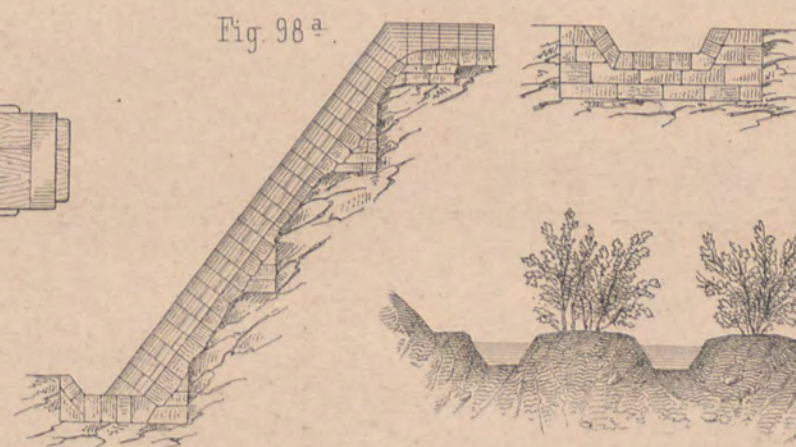

Fig. 98^a.

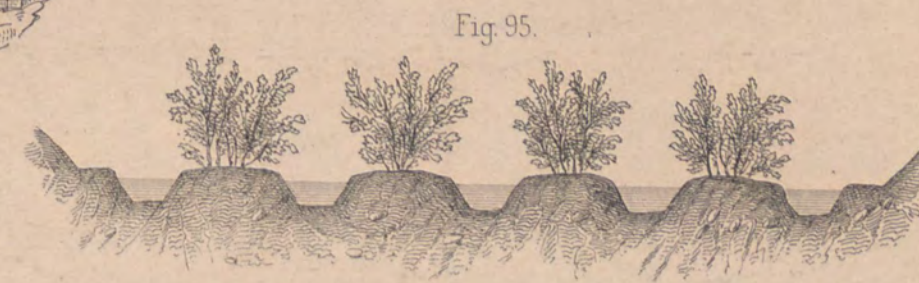

Fig. 95.

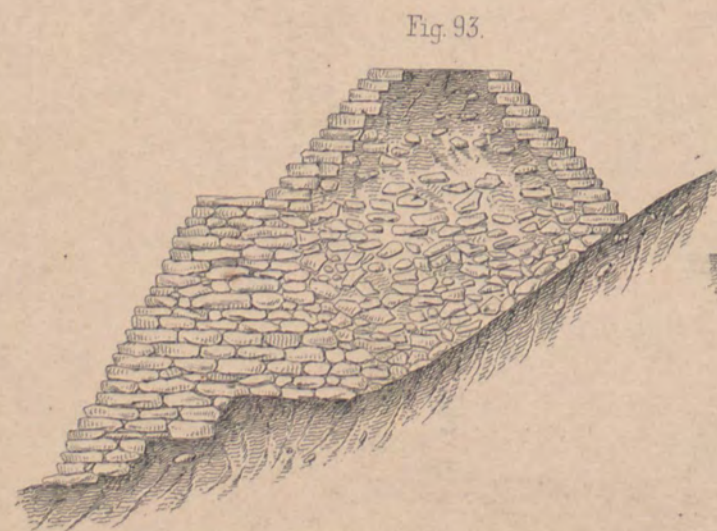

Fig. 93.

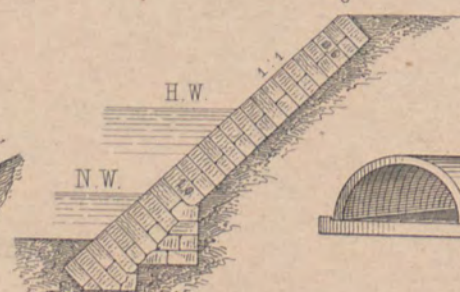

Fig. 96.

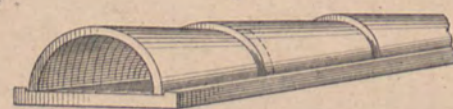

Fig. 94.



Fig. 92.

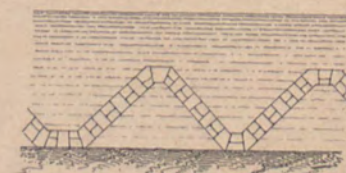

Fig. 92^a.

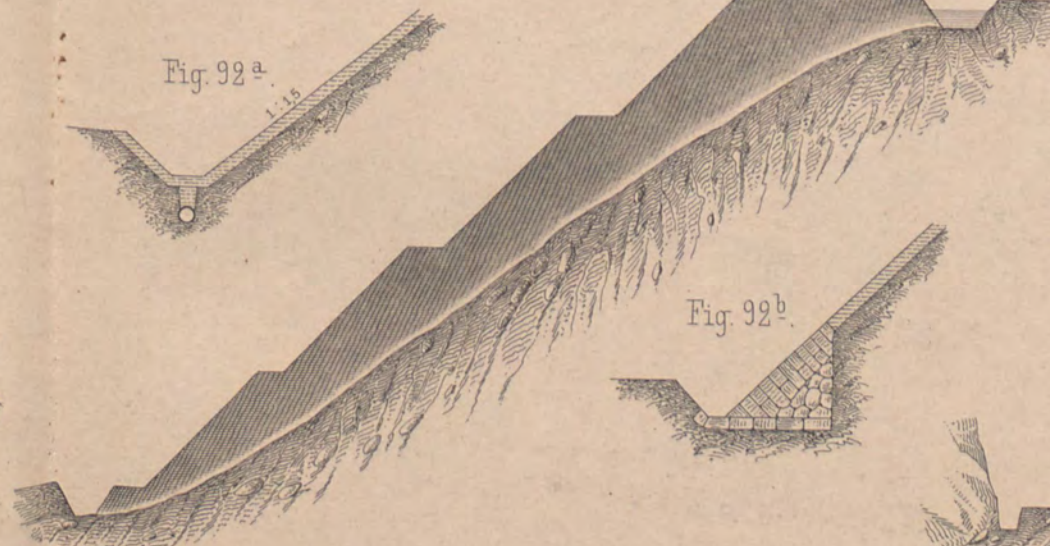

Fig. 97.

Fig. 92^b.



Fig. 98.

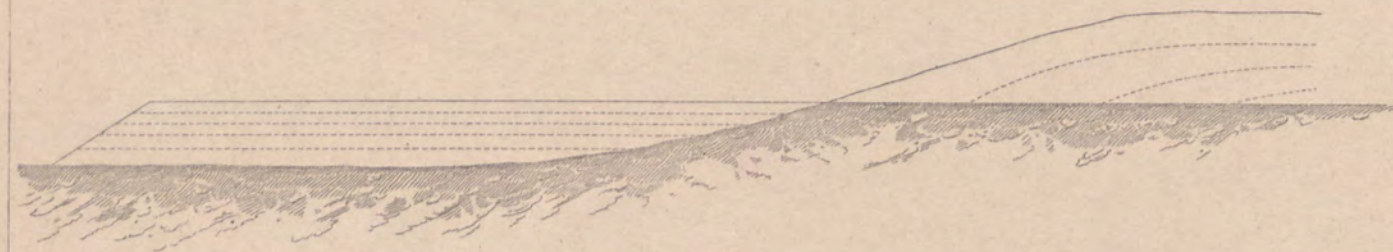

Fig. 99.

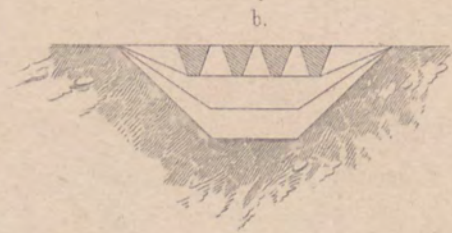
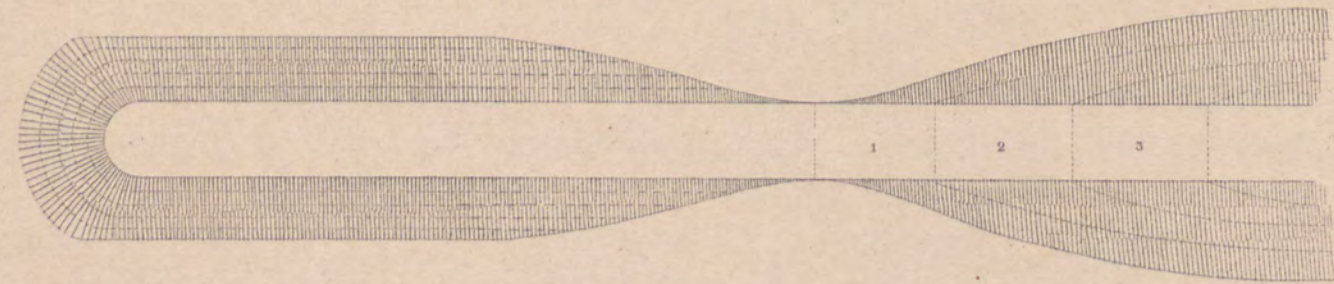

Fig. 100.

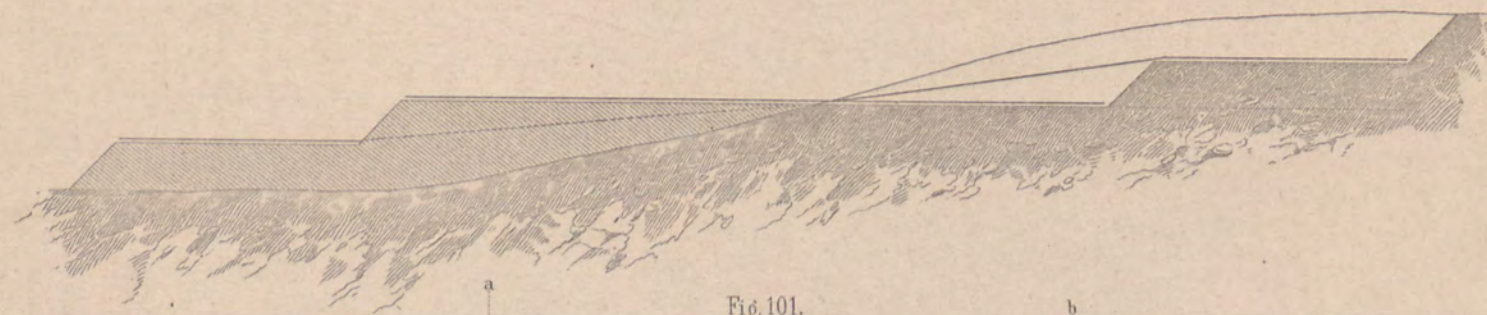
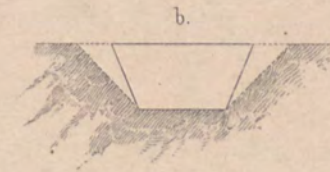
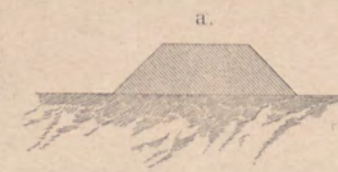
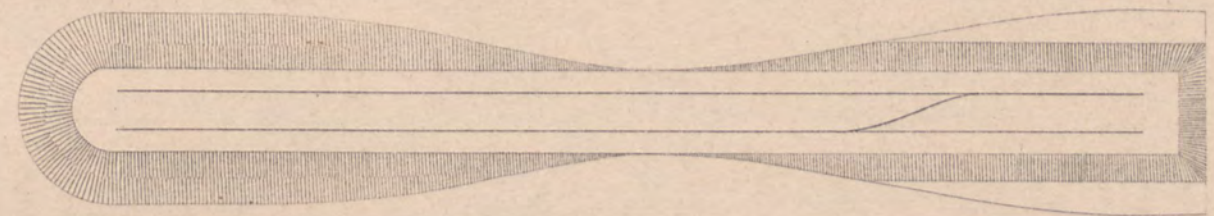

Fig. 101.

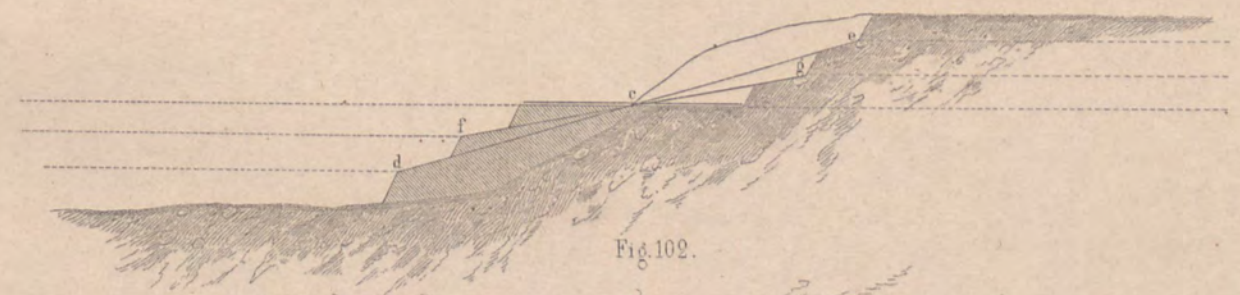
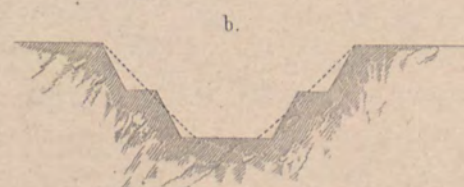
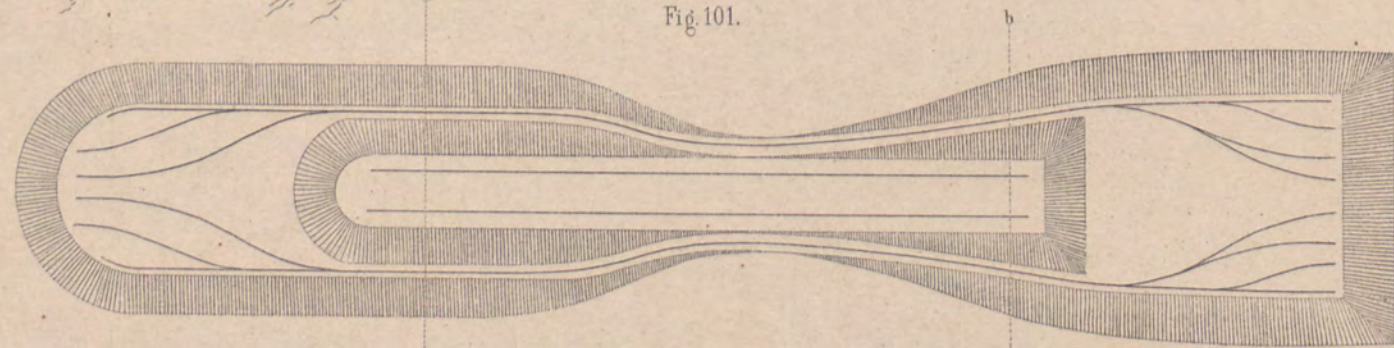
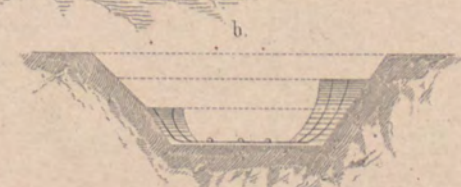
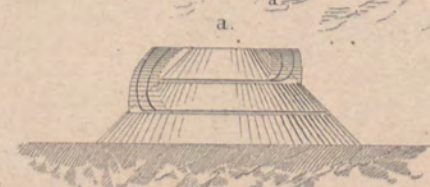
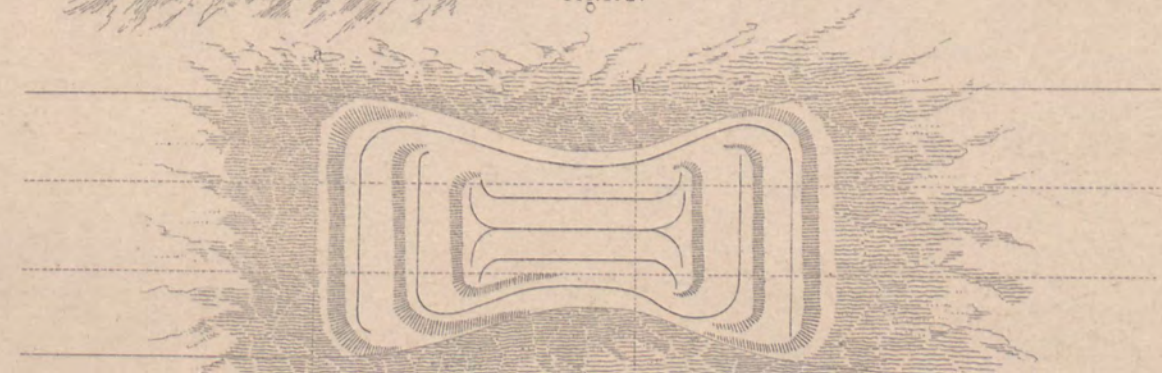

Fig. 102.



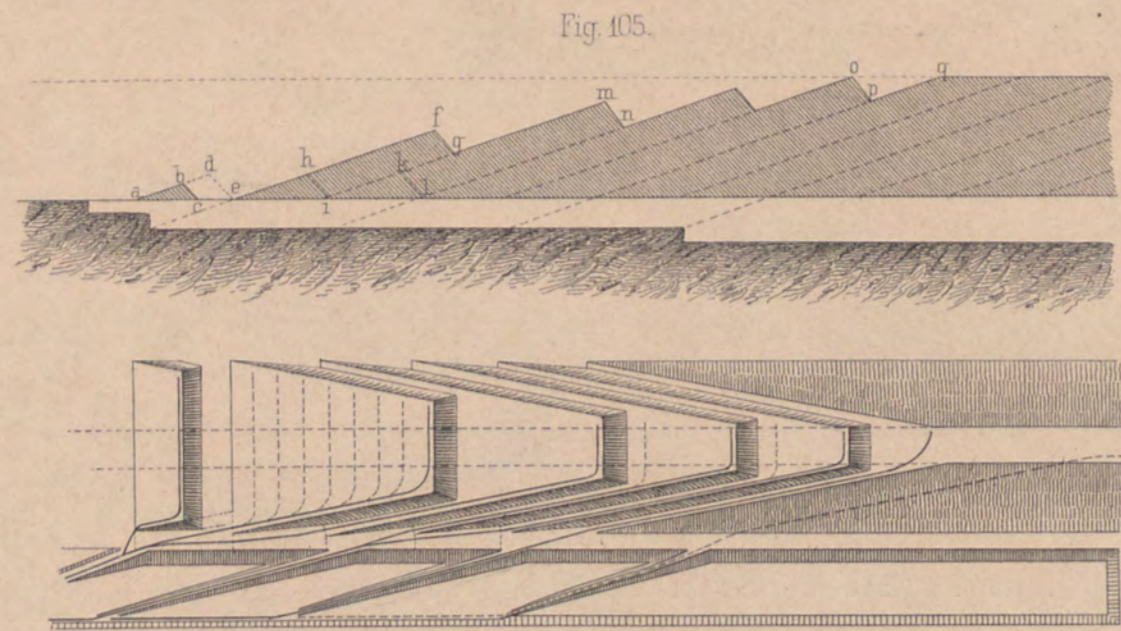

Fig. 105.

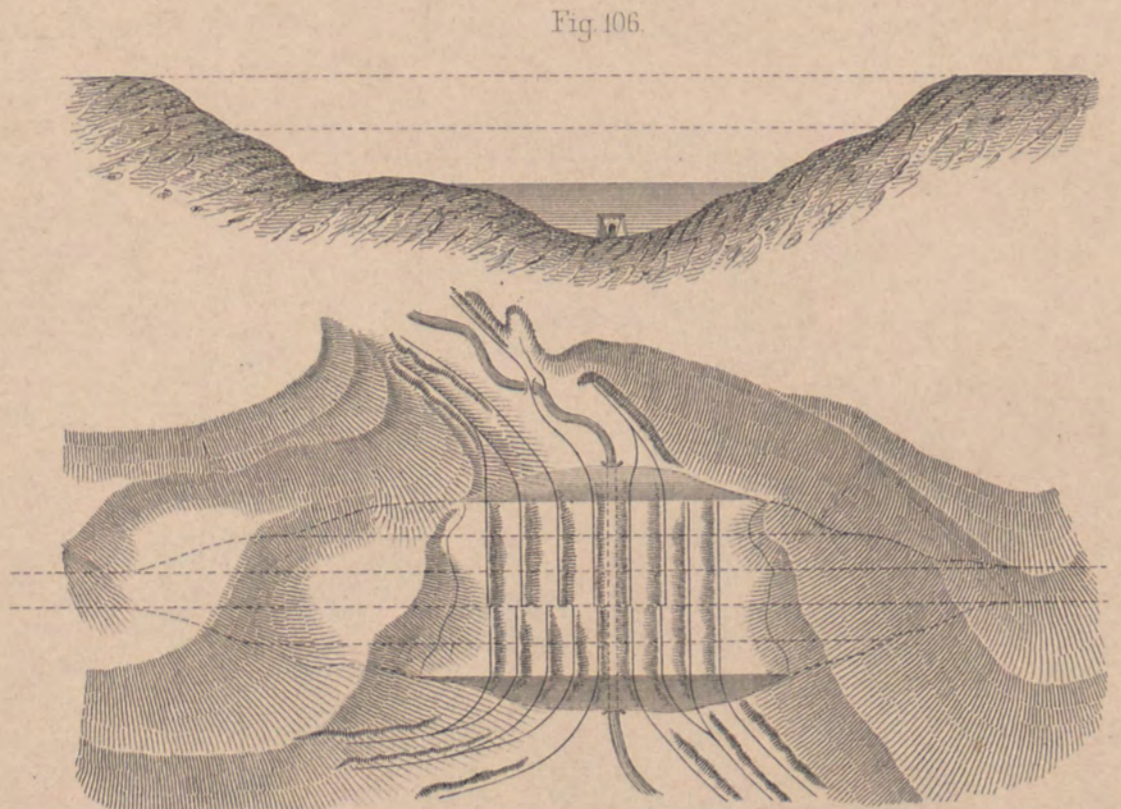

Fig. 106.

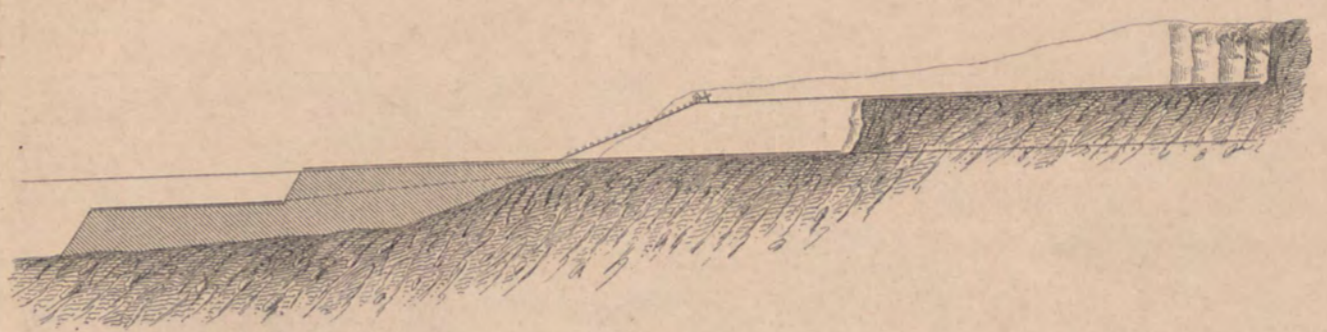
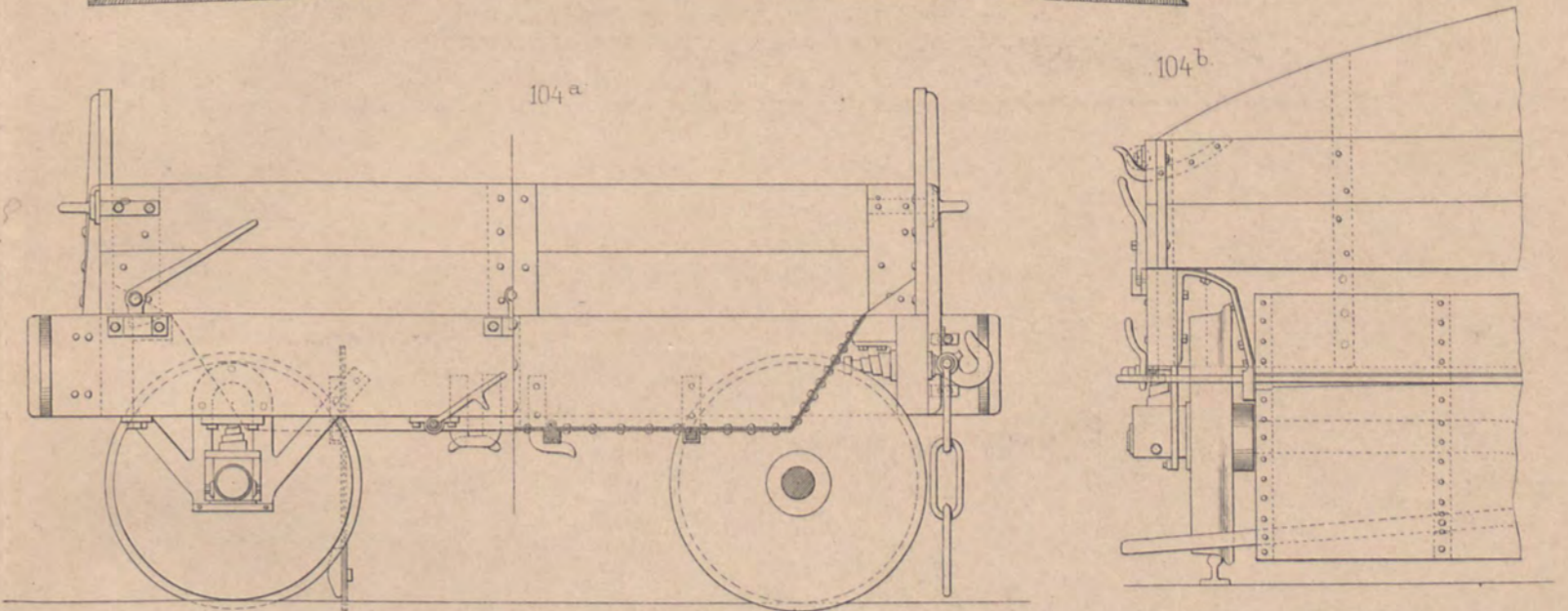
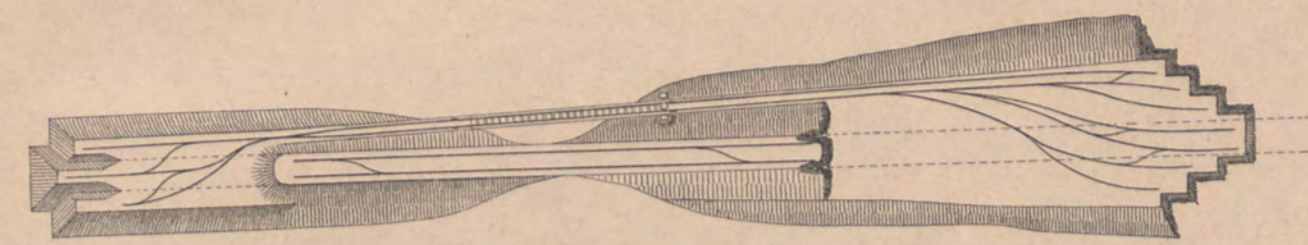

Fig. 103.



Boden-Kipper (Thomas in Dresden, beim Bau d. Nordh. Erf. Bahn mit d. Lokomotive fortbewegt)
(Inhalt 3 kb^m lose Masse)

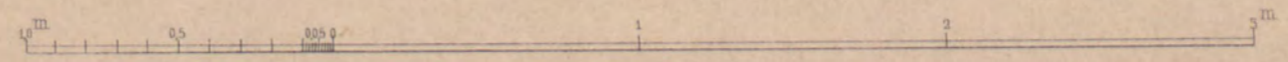
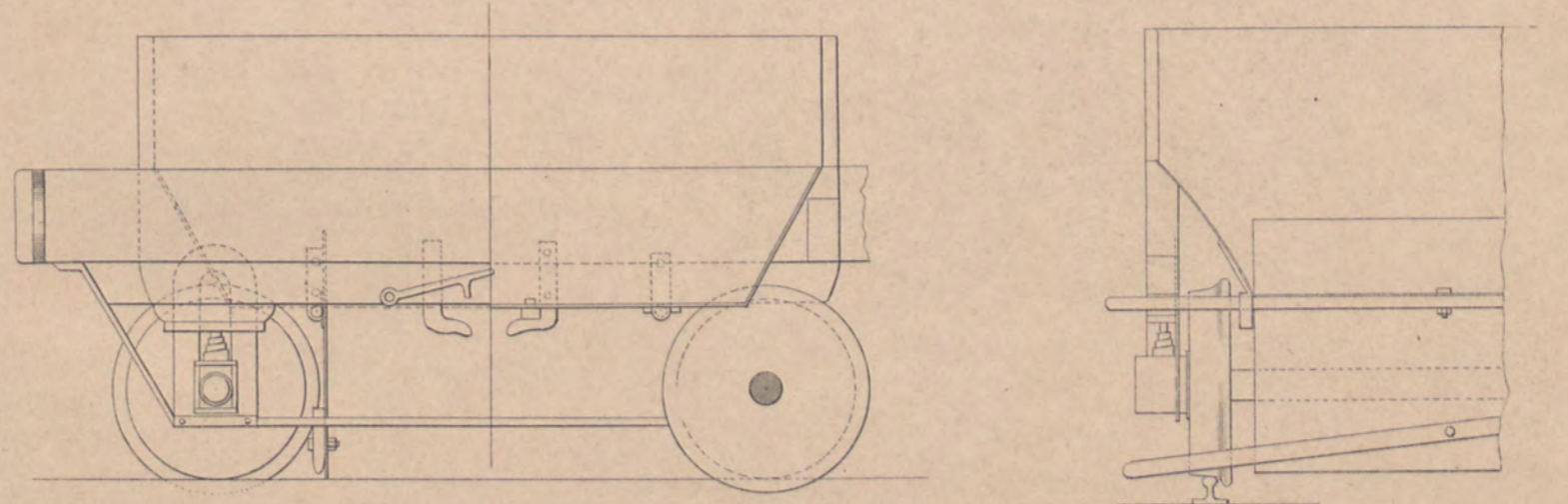
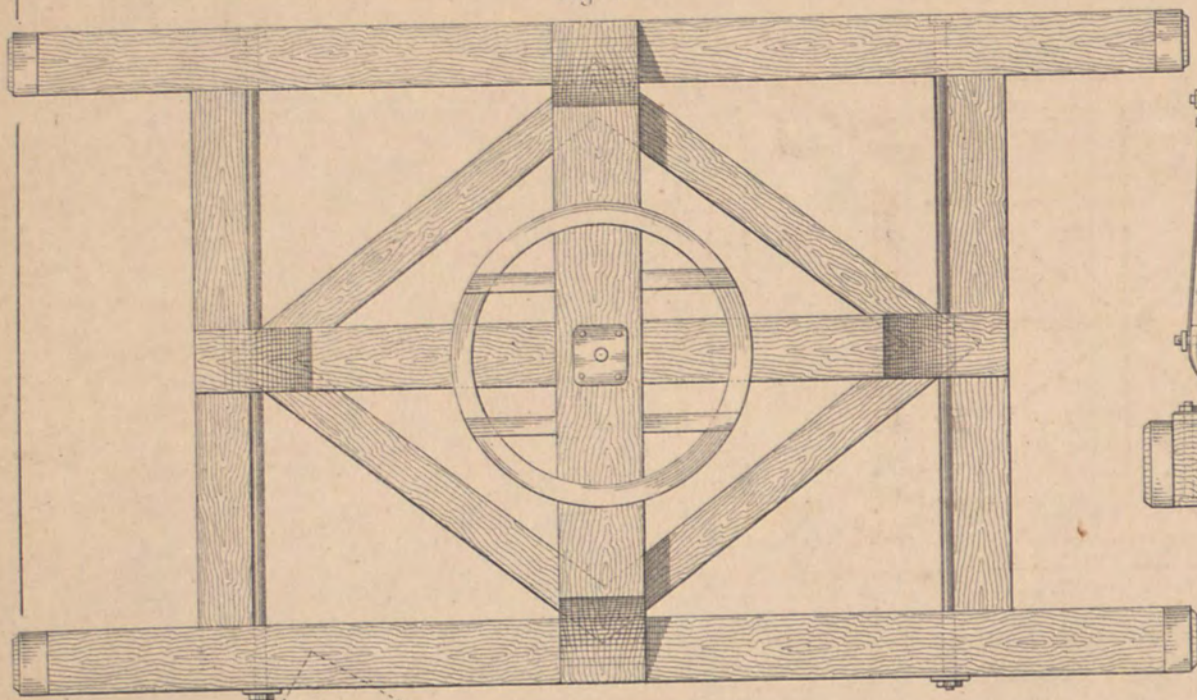
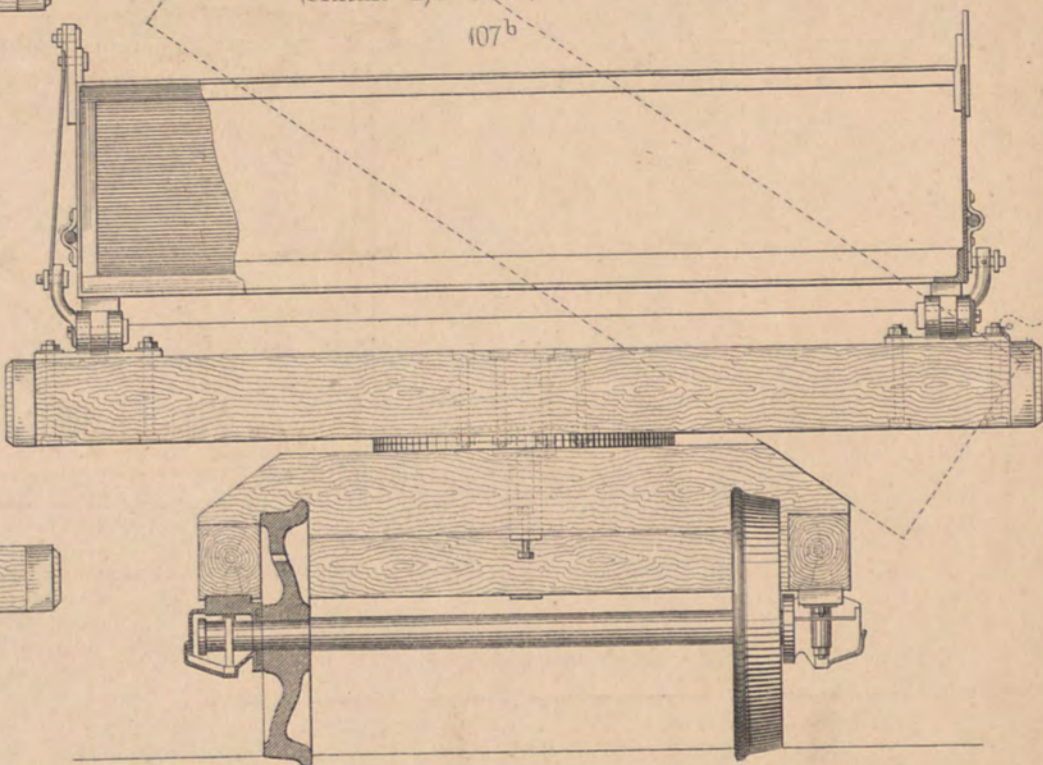

Fig. 107^a



Französischer Universal-Kippwagen auf Drehschemel mit eisernem Kasten.
(Inhalt 1,4 kb^m)

107^b



Maassstab 1/16 natürl. Grösse.

107^d

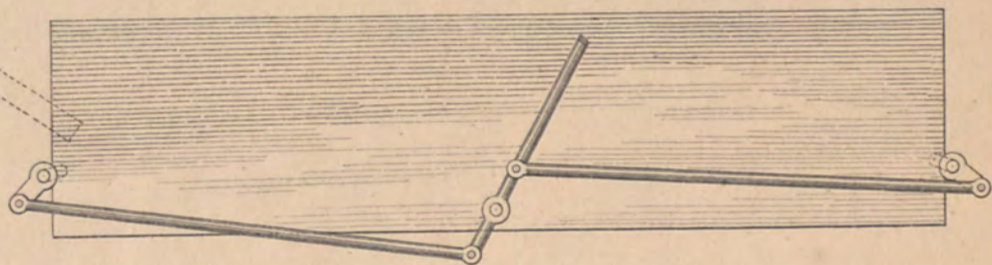

107^c

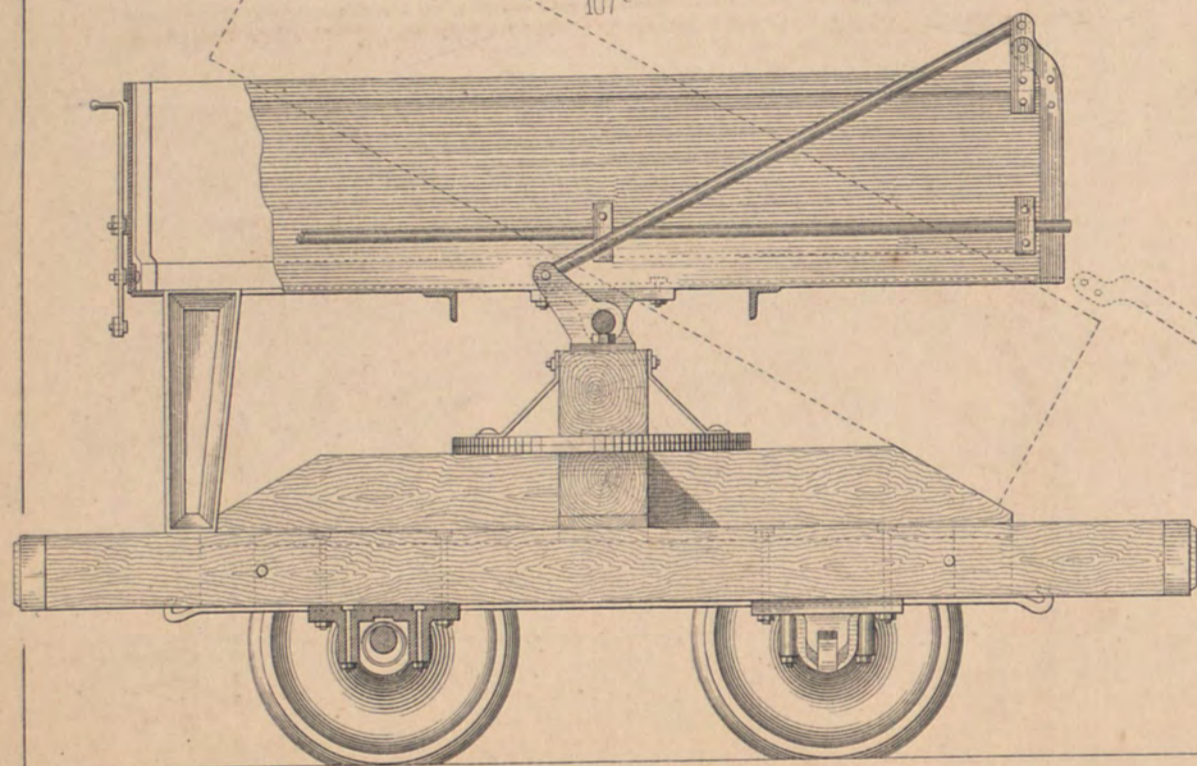

Inhalt des Kastens, massig gehäuft 2 kb^m feste Abtragsmasse.

Fig. 108^a

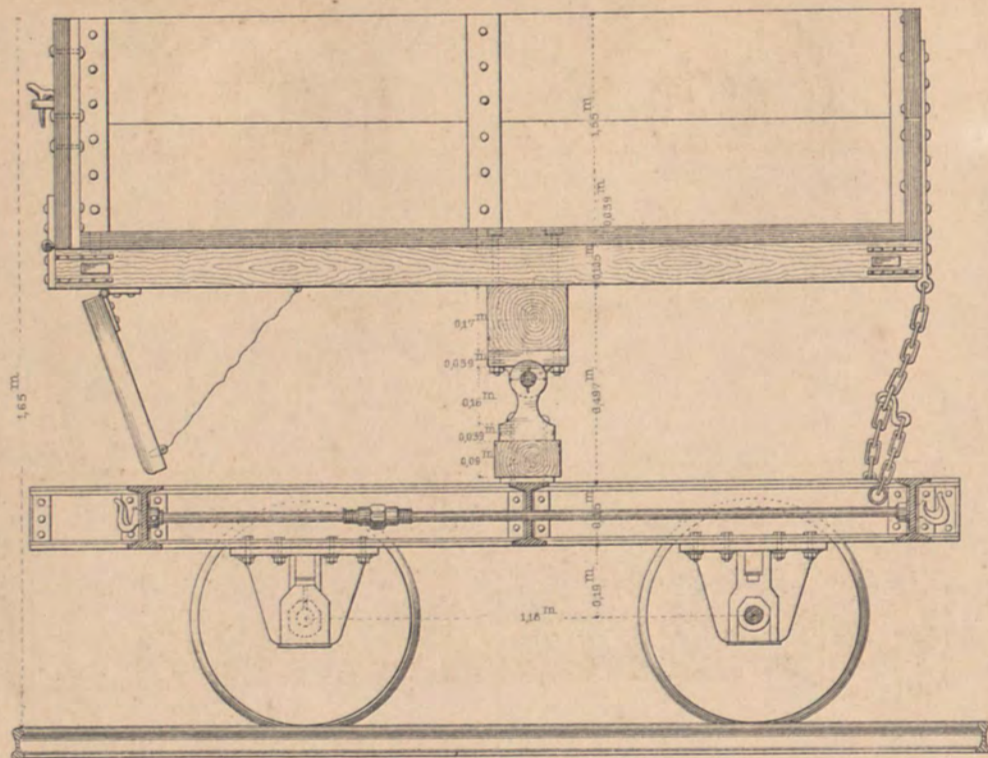

Kippwagen mit eisernem Untergestell (von Plessner)

108^b

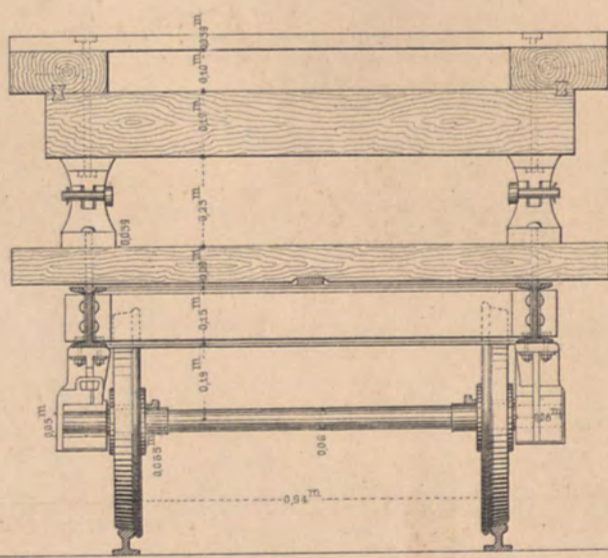

108^c

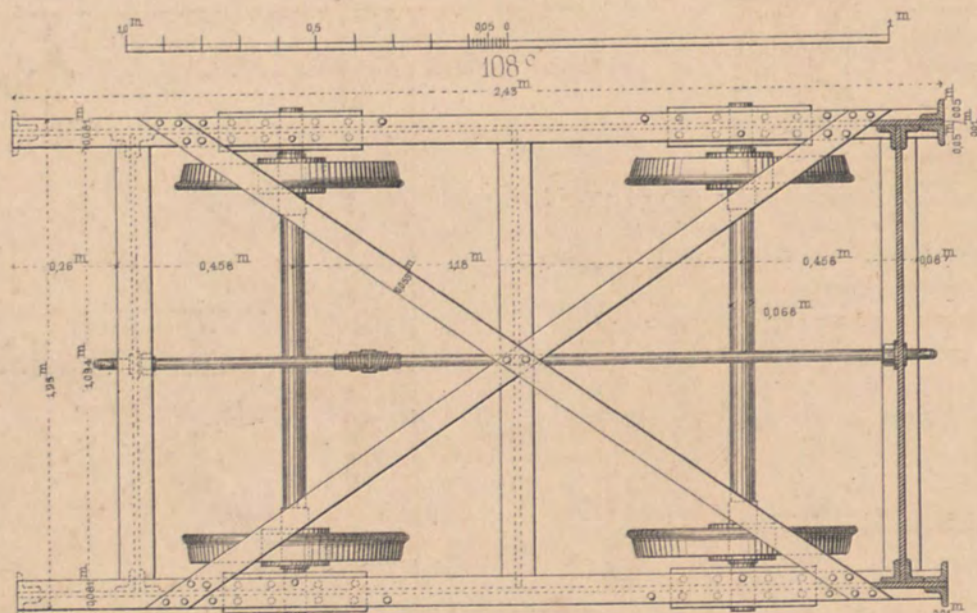

Kipp-Waggon (Patent Wens).

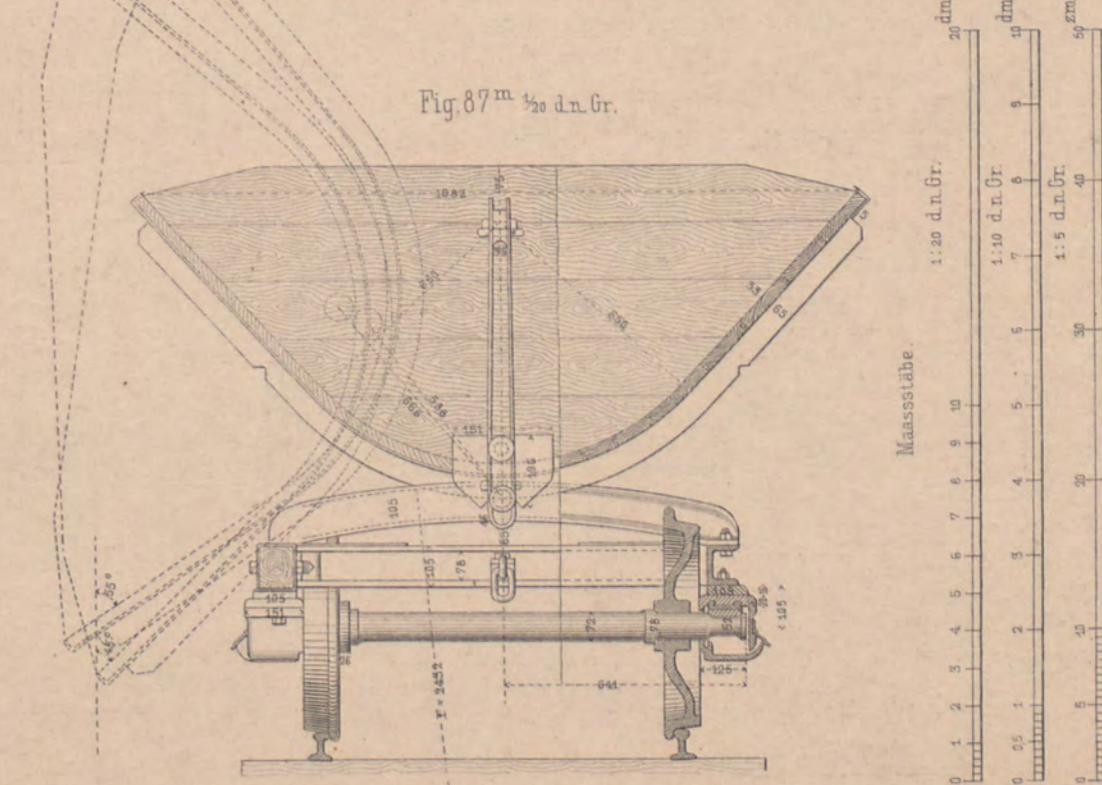
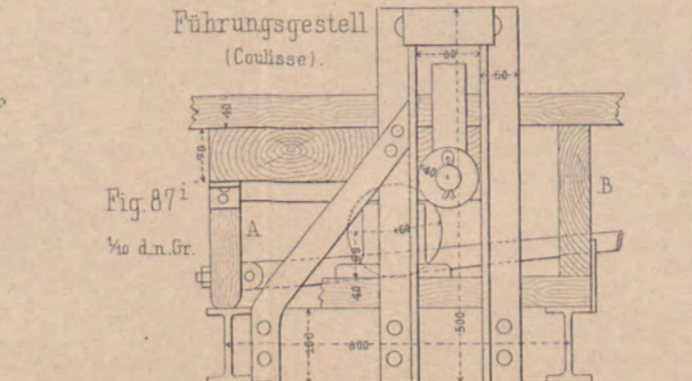
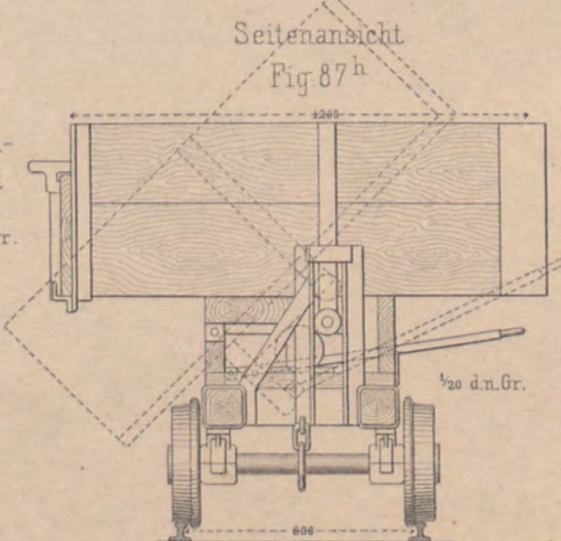
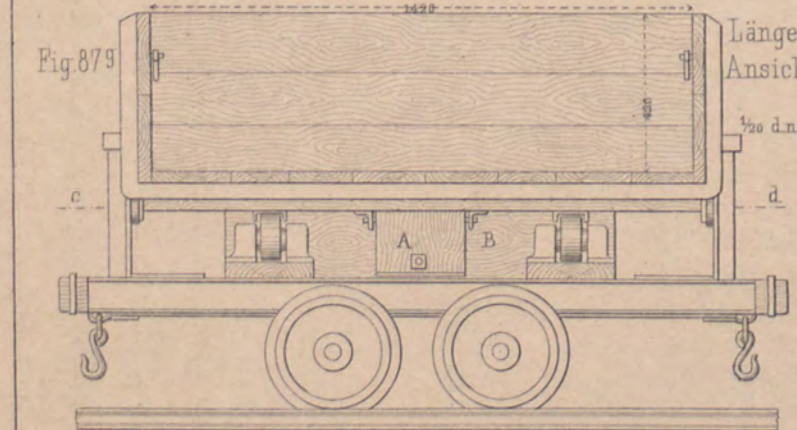
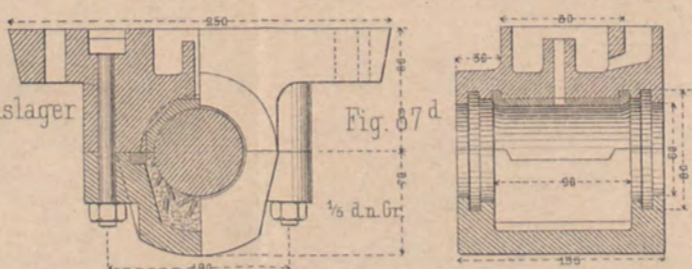
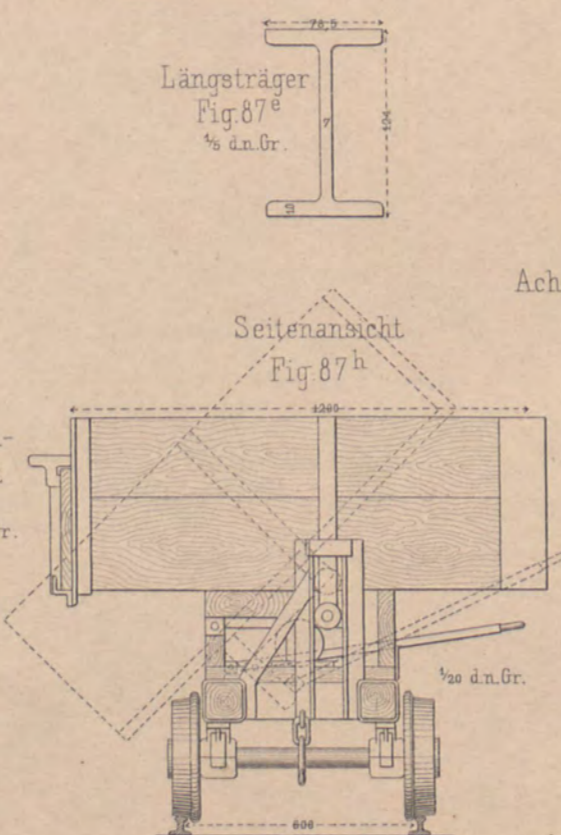
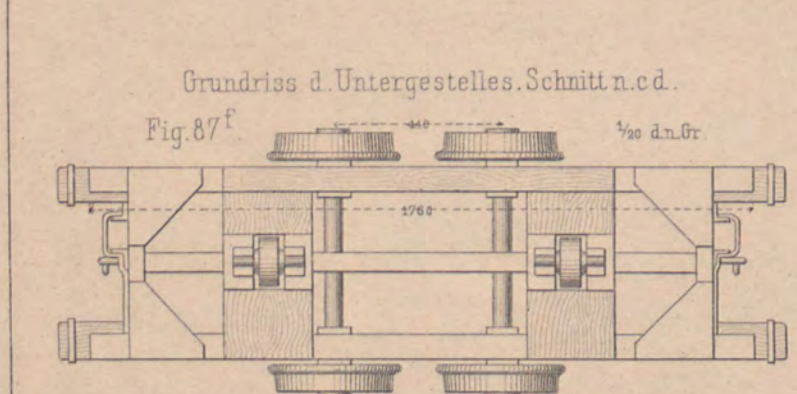
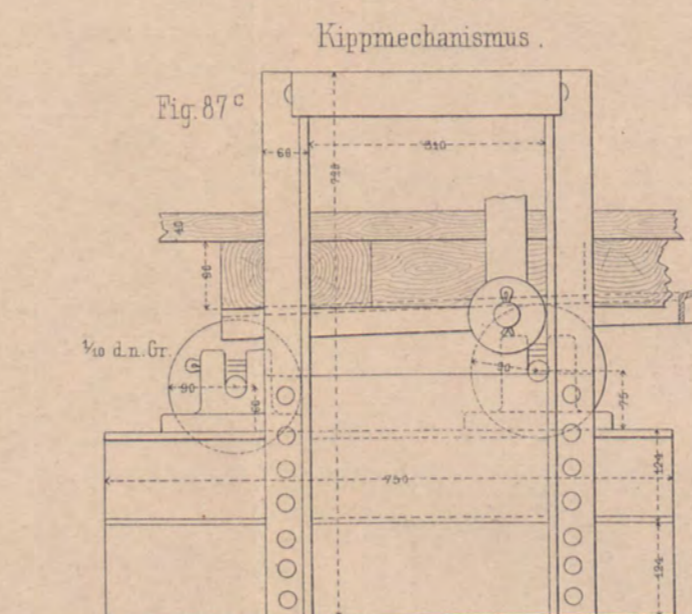
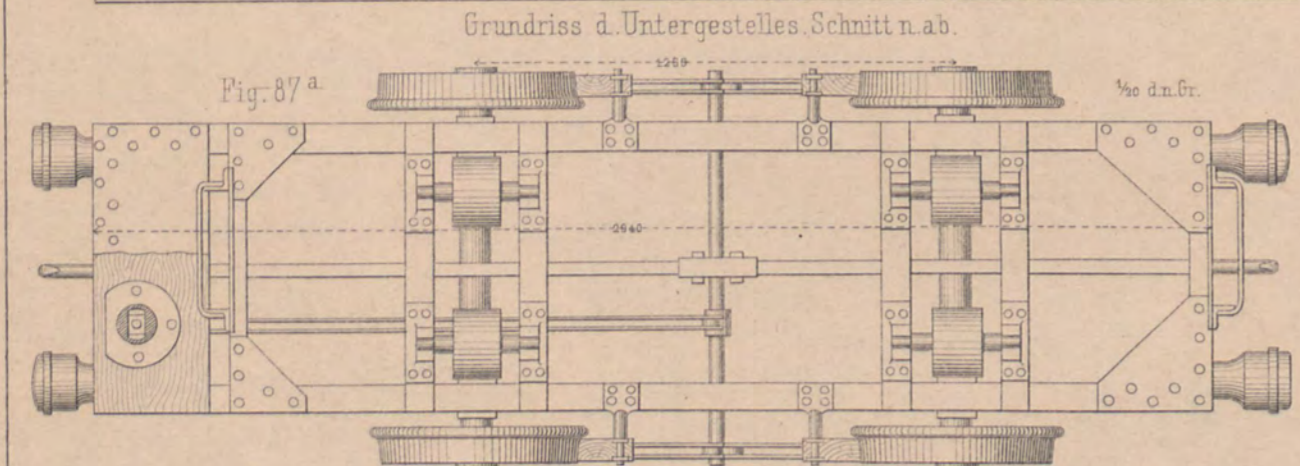
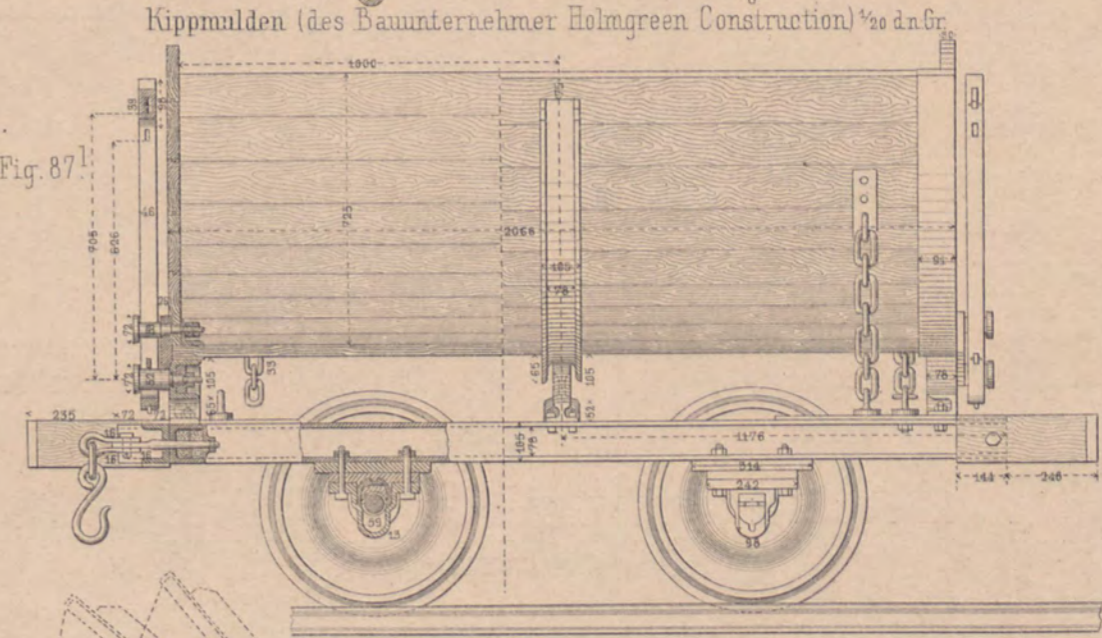
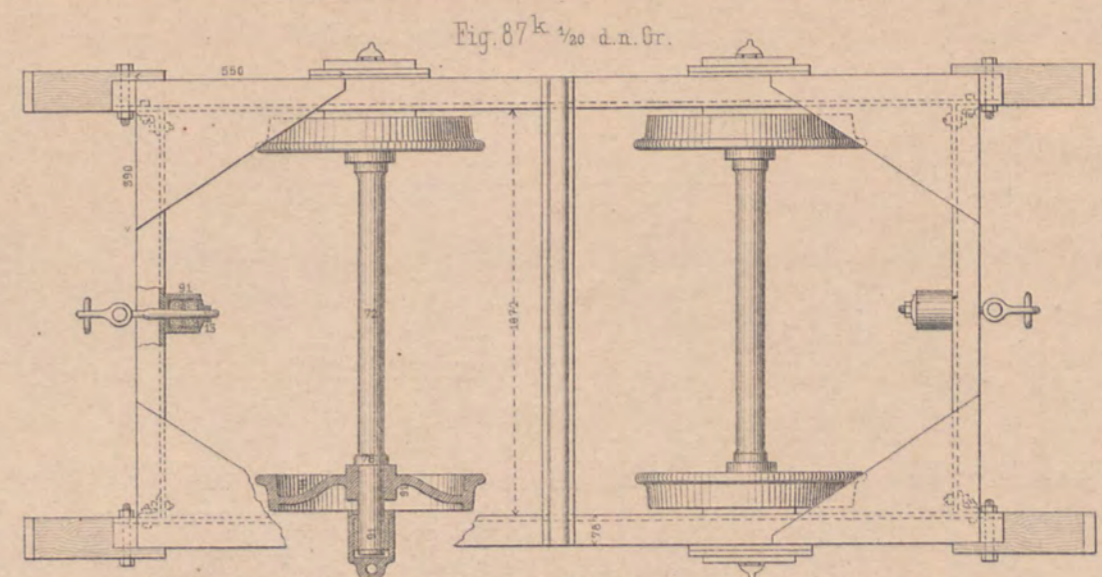
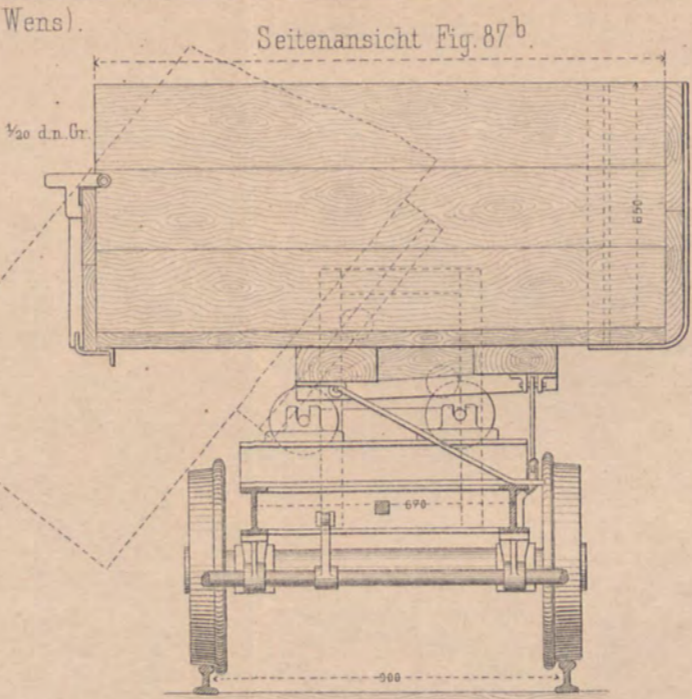
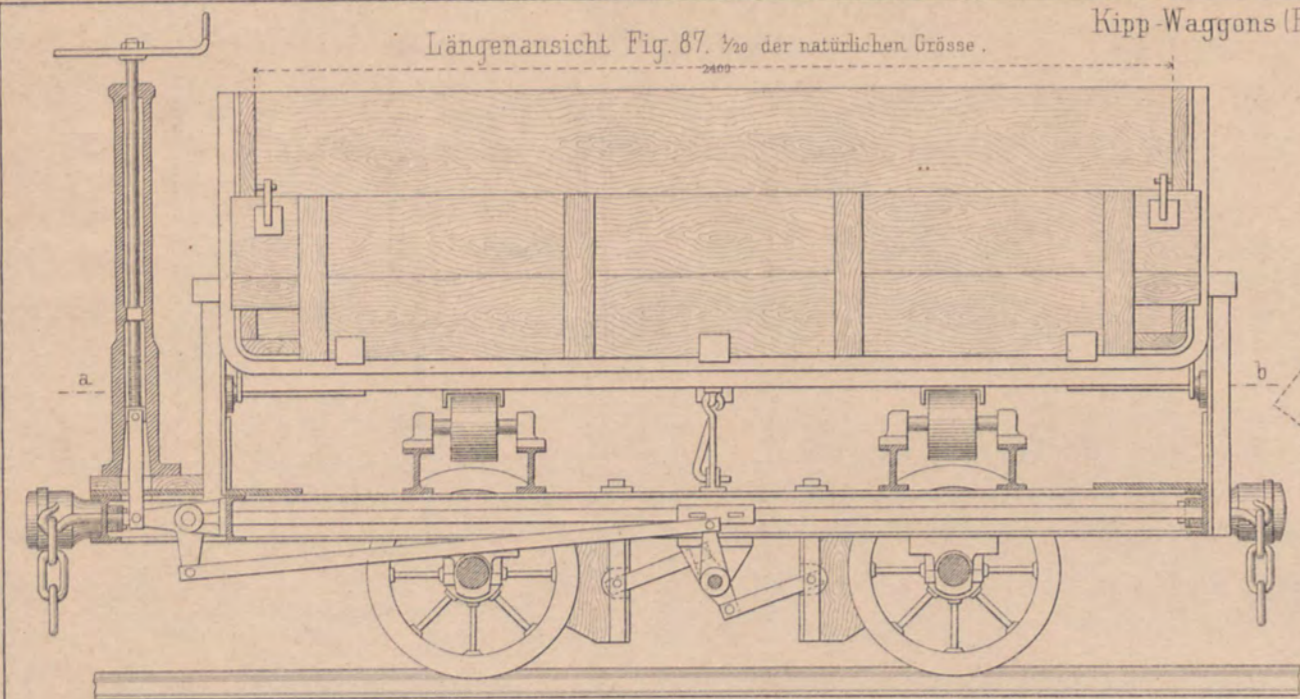

Fig. 109.

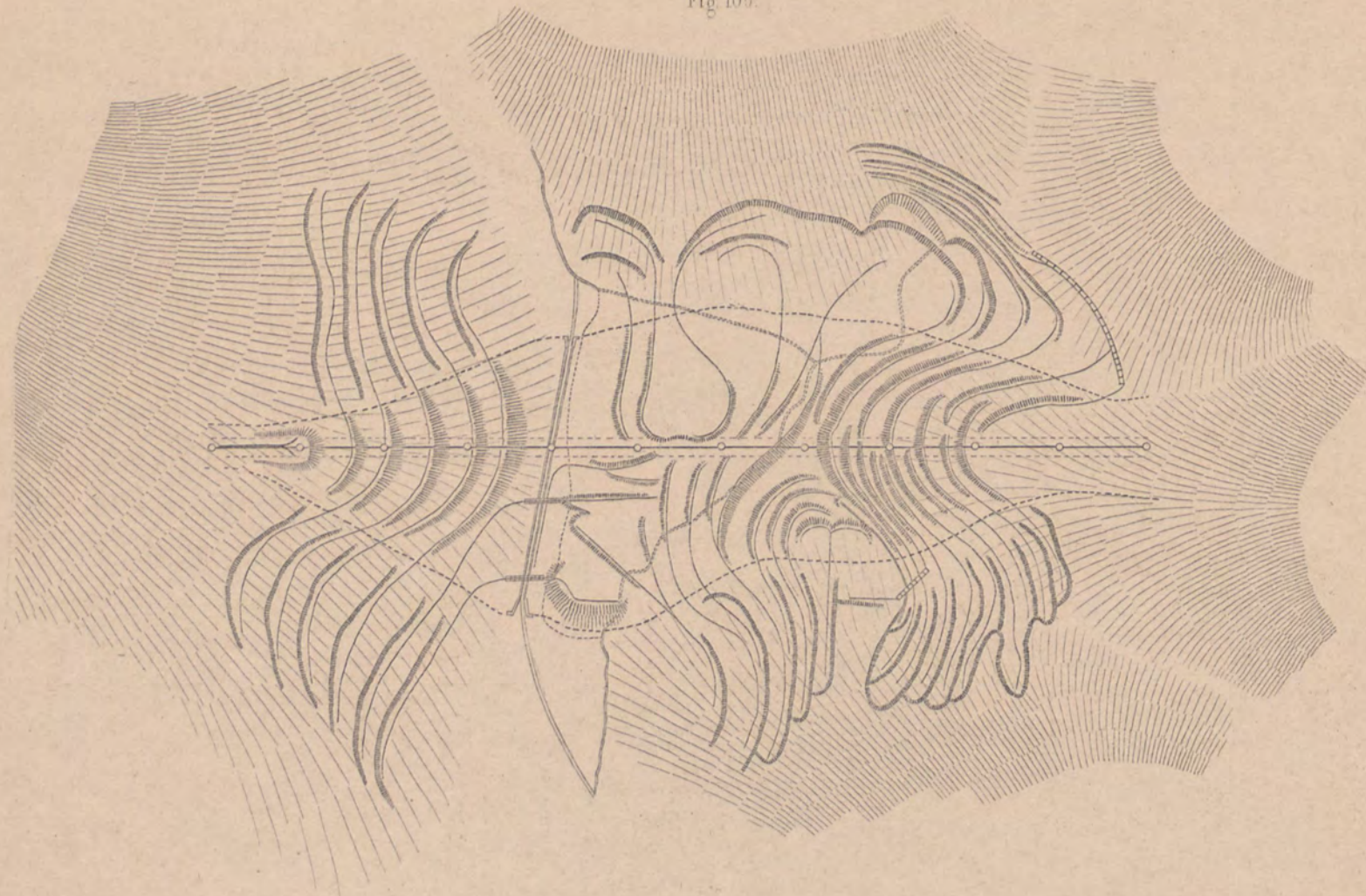

Fig. 110.

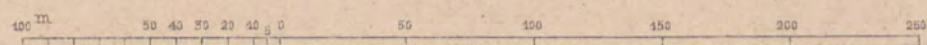
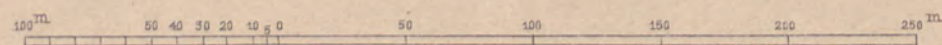
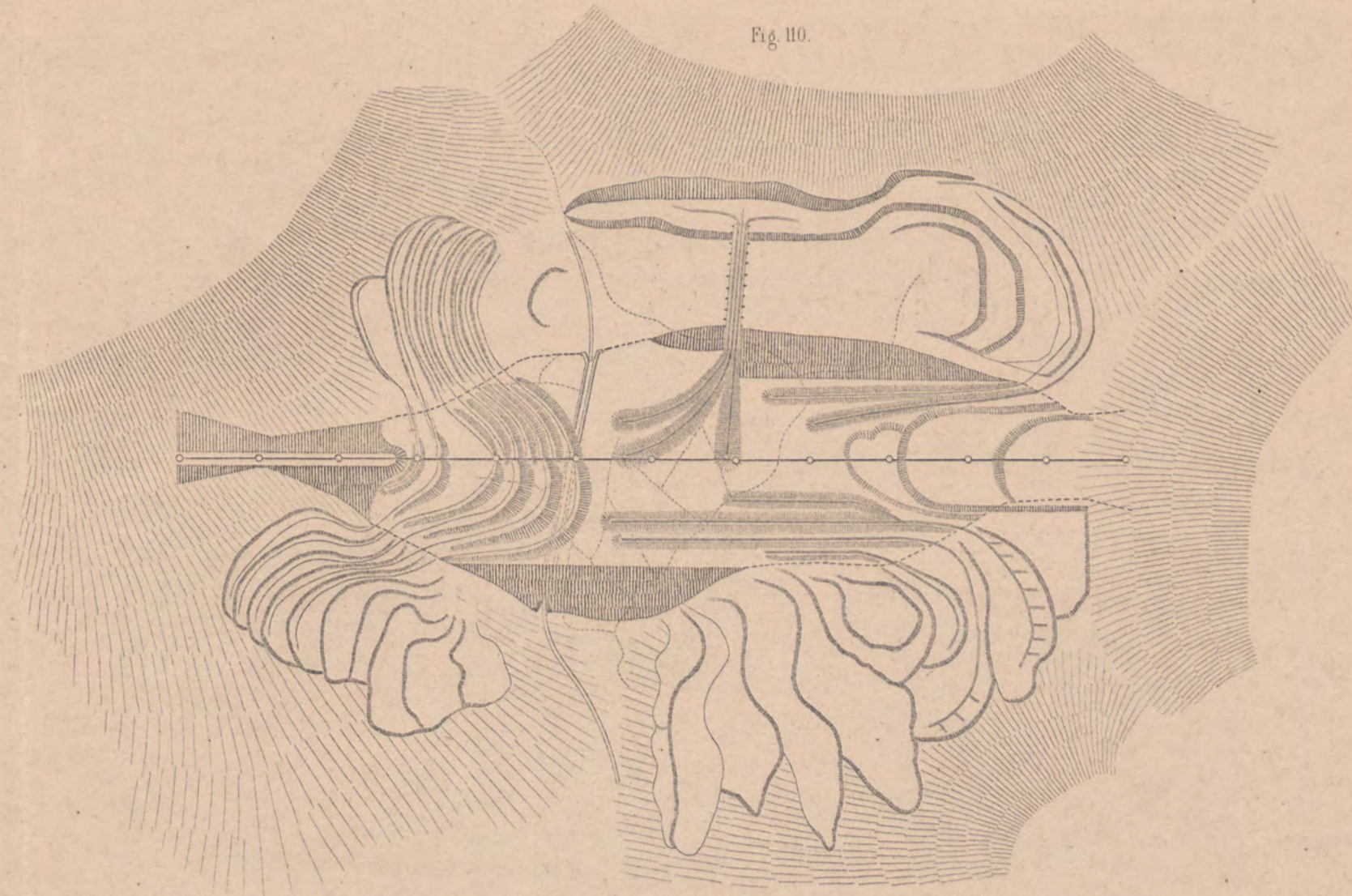

Fig. 111.

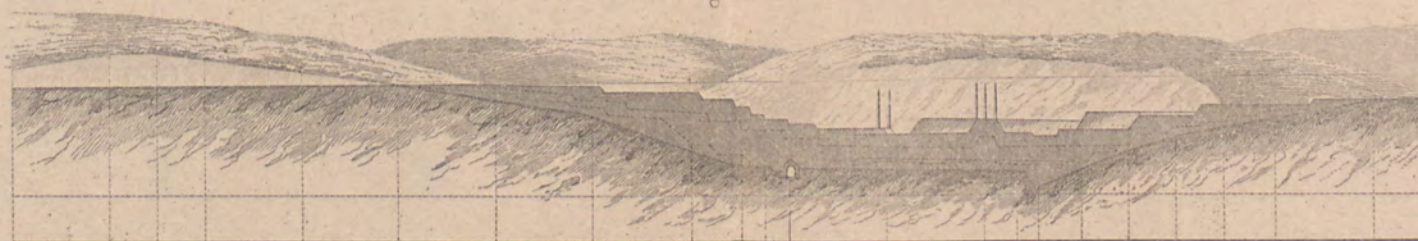

Fig. 112.

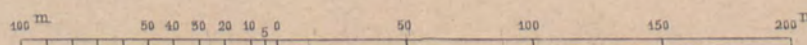
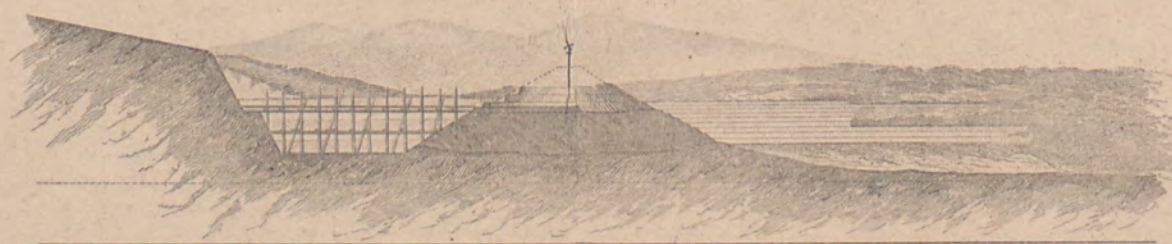

Fig. 113.

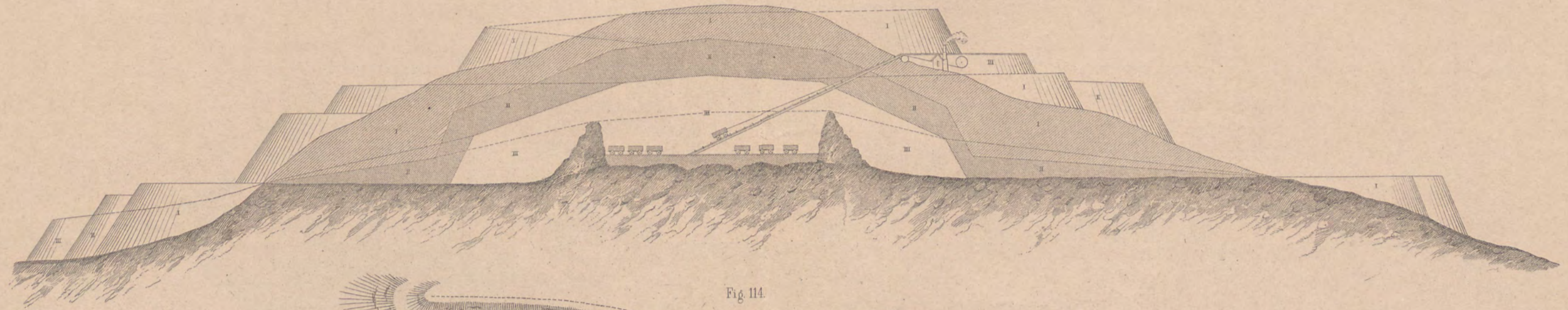

Fig. 114.

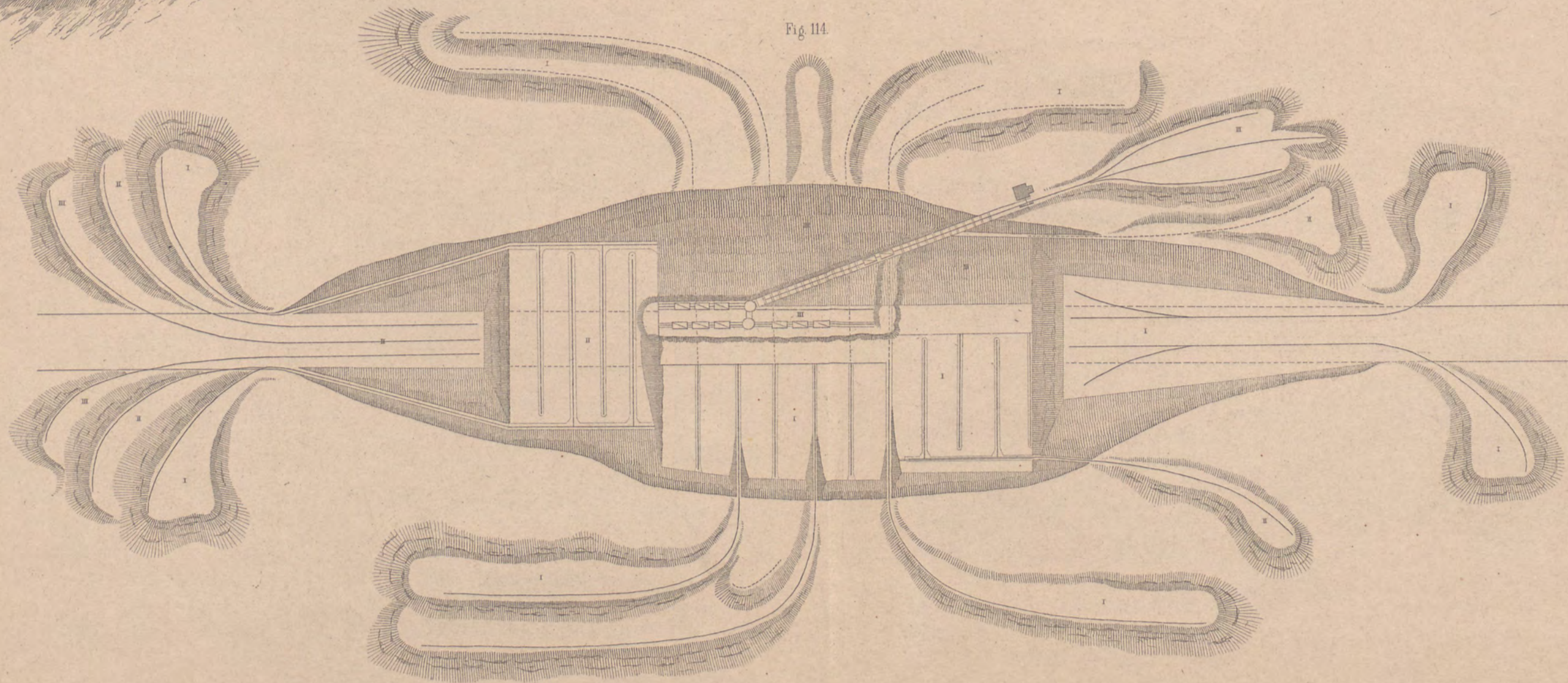

Fig. 115.

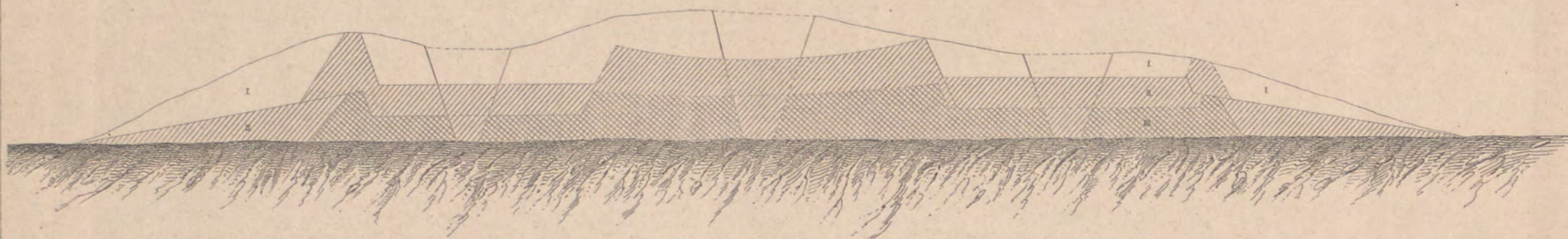

Fig. 116.

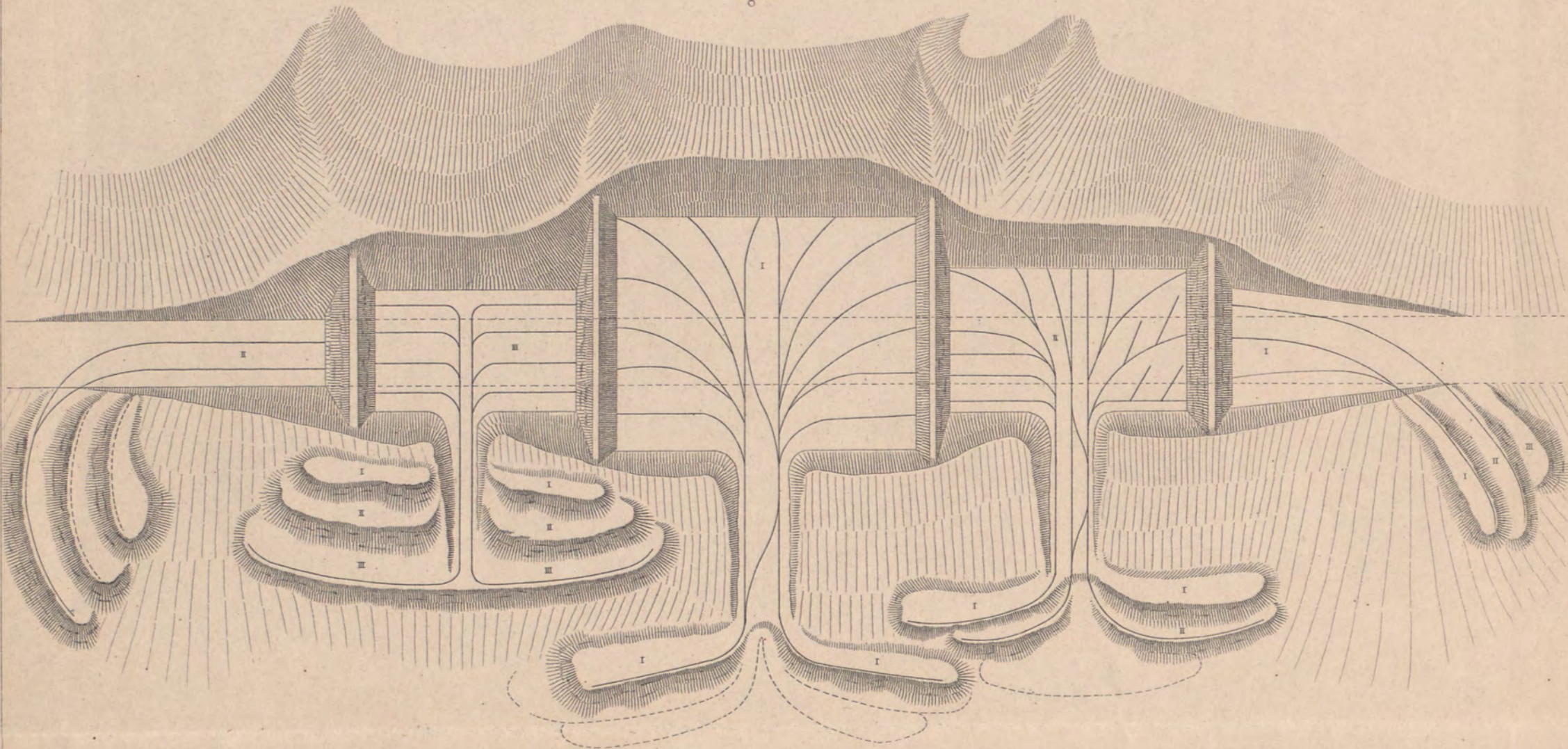

Fig. 117.

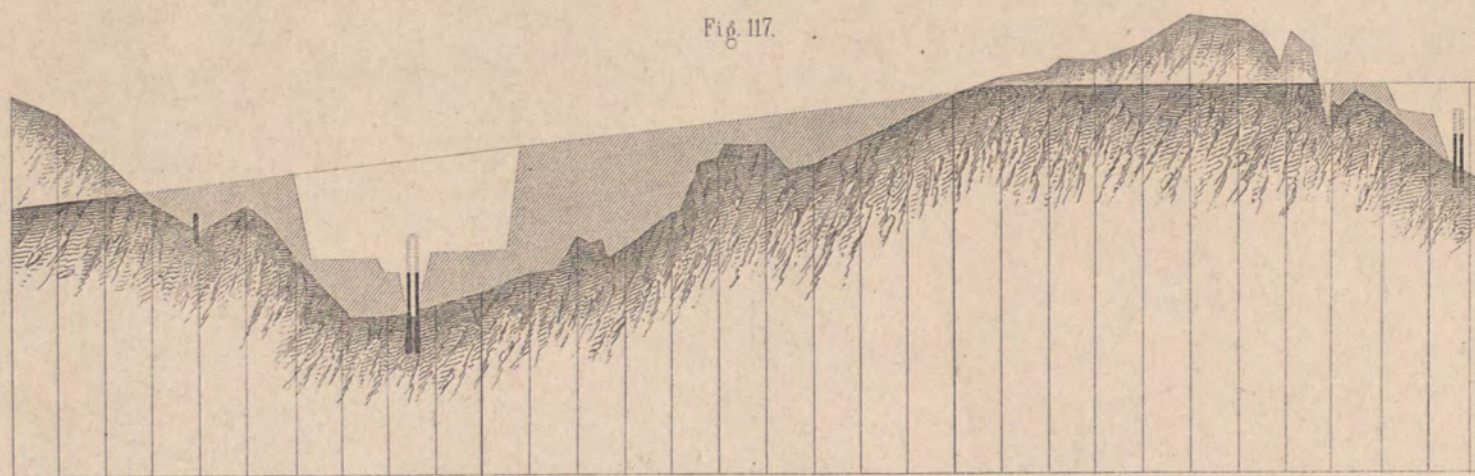

Fig. 118.

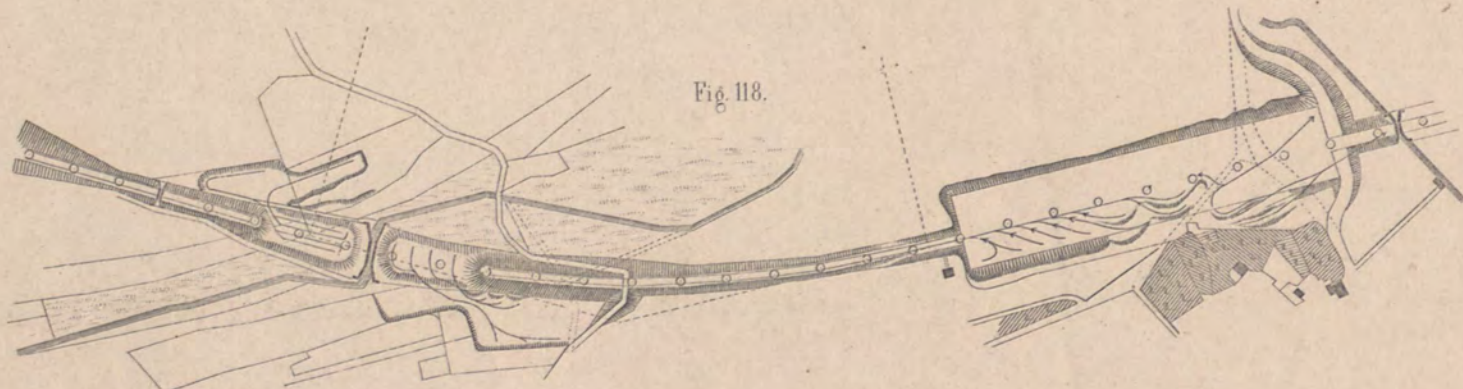

Fig. 119.

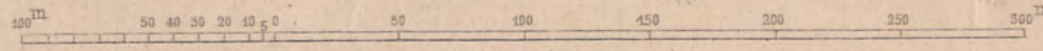
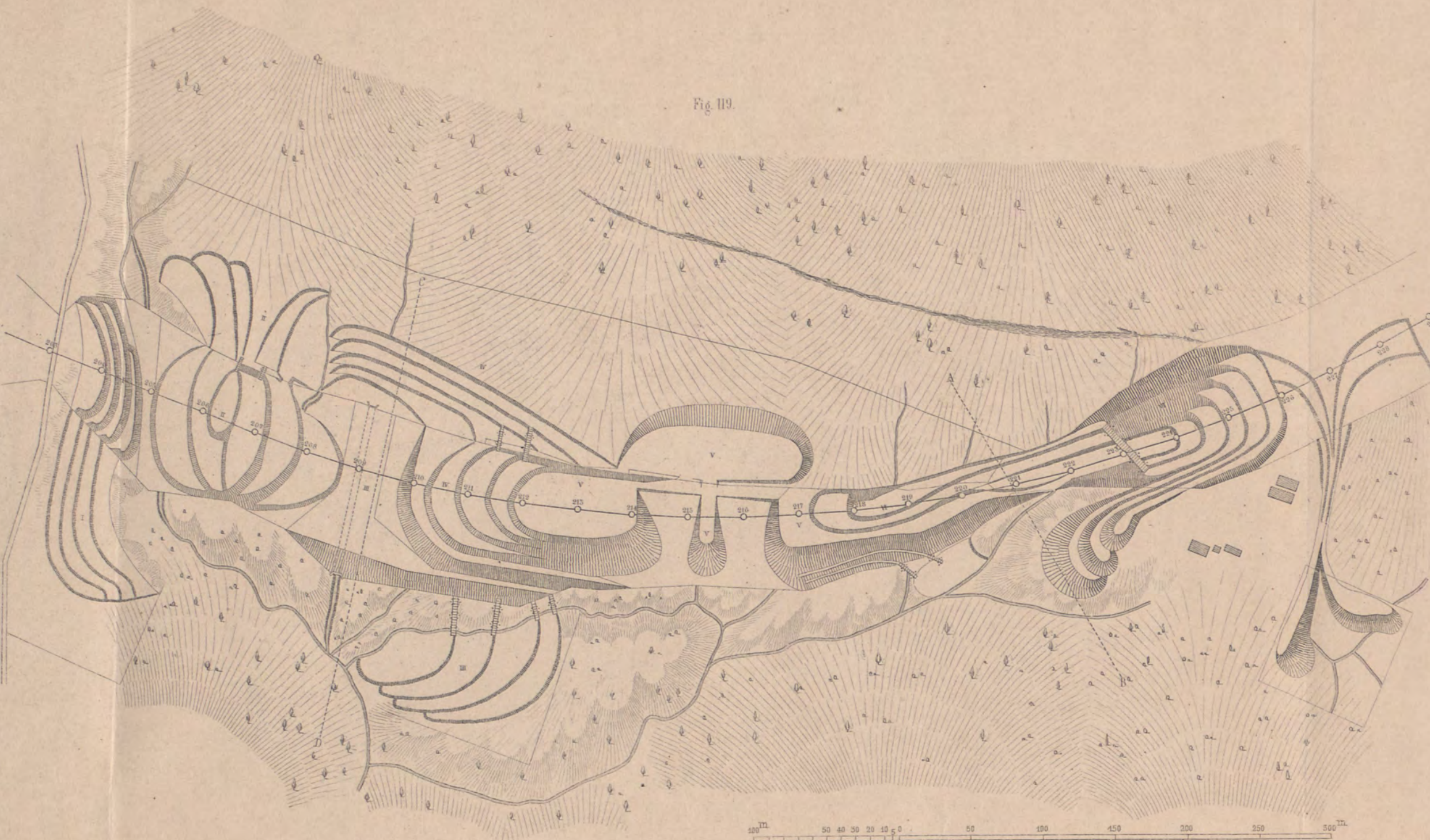

Fig. 120.

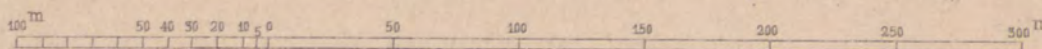
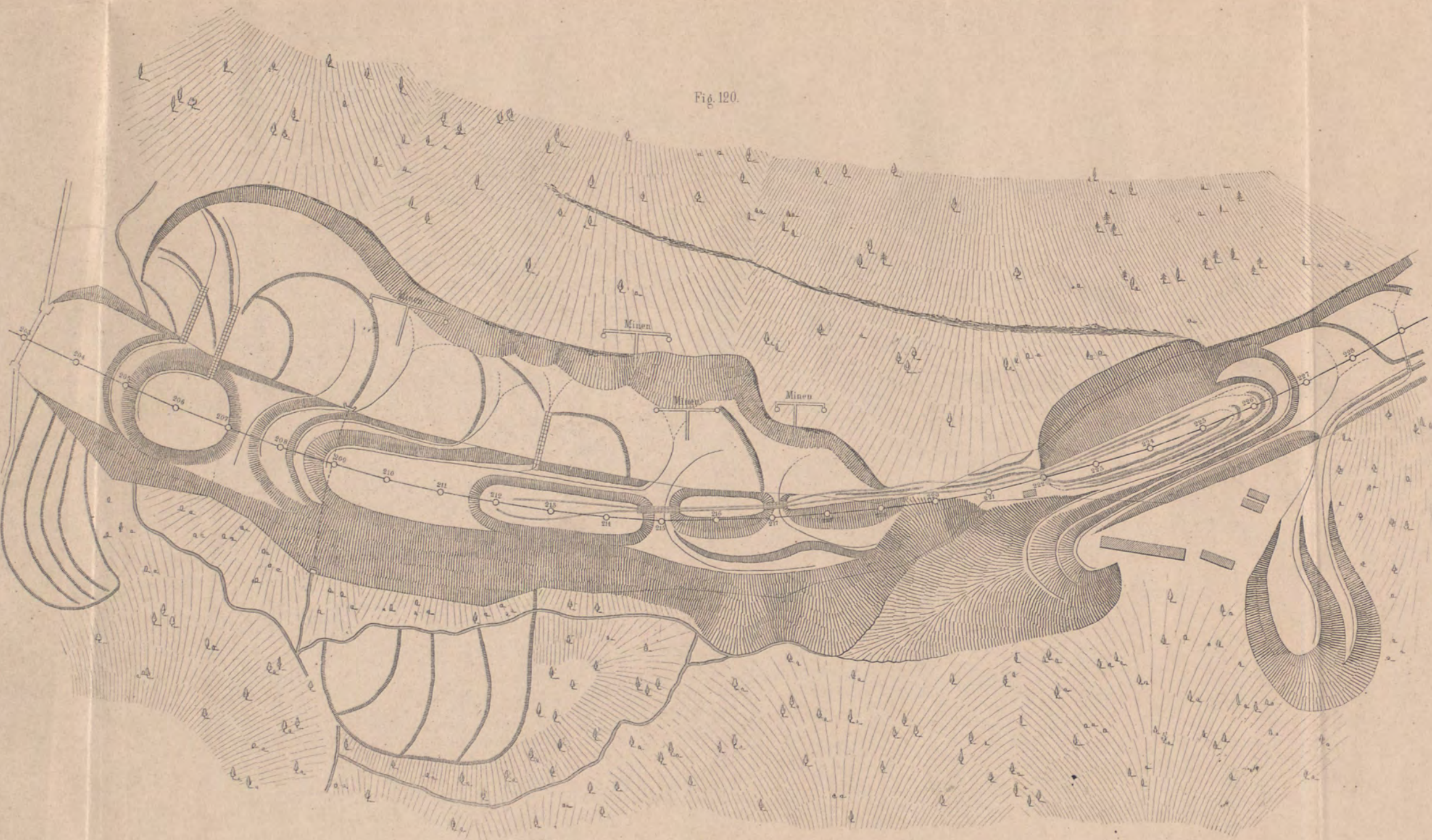

Fig. 121. Längen-Profil.

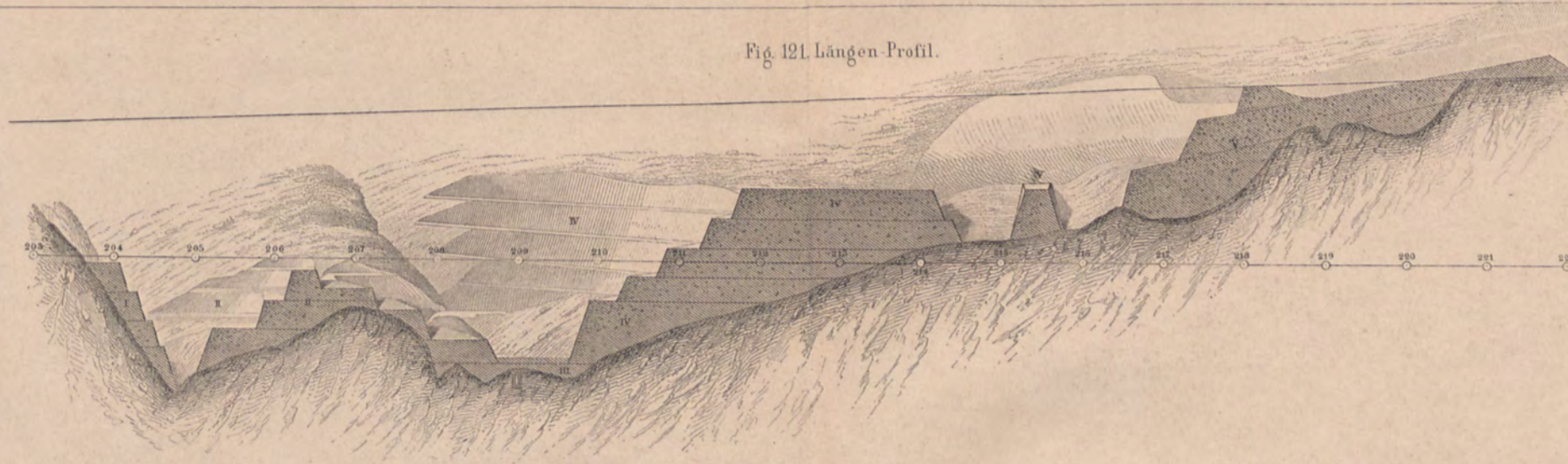

Fig. 122. Quer-Profil AB.

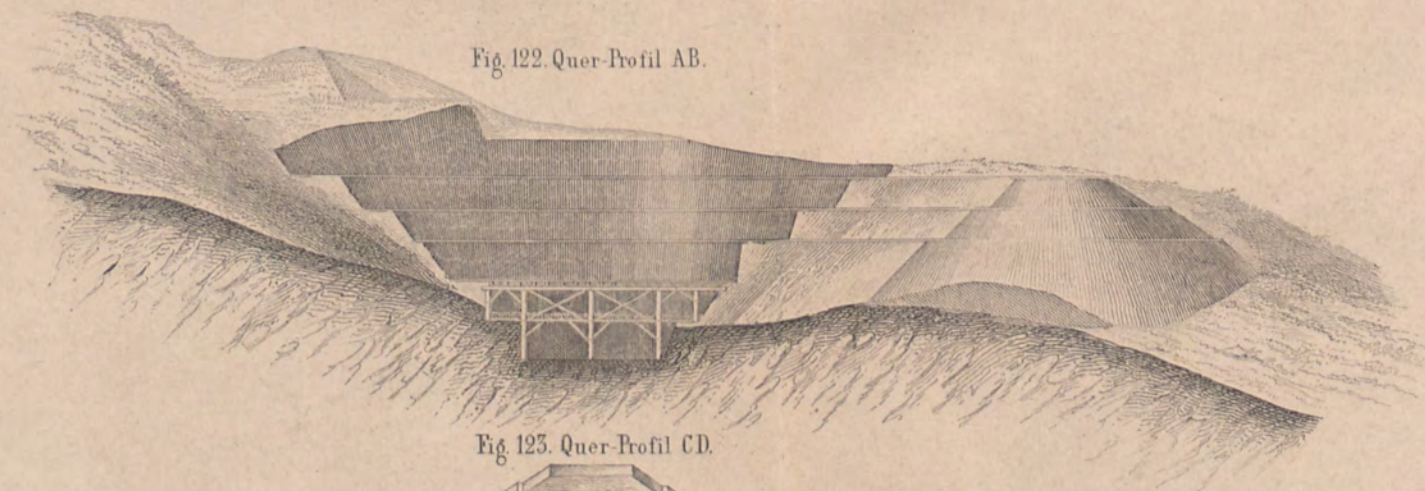

Fig. 123. Quer-Profil CD.

