

*Kat. Bud. Dr. Pol.*



**NOUVEAU PORTEFEUILLE**  
DE  
**L'INGÉNIEUR DES CHEMINS DE FER**

**PAR MM. AUGUSTE PERDONNET**

ANCIEN ÉLÈVE DE L'ÉCOLE POLYTECHNIQUE  
PROFESSEUR A L'ÉCOLE CENTRALE DES ARTS ET MANUFACTURES, ANCIEN INGÉNIEUR EN CHEF DE PLUSIEURS CHEMINS DE FER  
MEMBRE DU COMITÉ DE DIRECTION DES CHEMINS DE FER DE L'EST

**ET CAMILLE POLONCEAU**

ANCIEN DIRECTEUR DES CHEMINS DE FER D'ALSACE  
INGÉNIEUR EN CHEF, RÉGISSEUR DU MATÉRIEL ET DE LA TRACTION AU CHEMIN DE FER D'ORLÉANS

**PLANCHES.**



*Invent. sub Litt. D. I. N. 153.*

PARIS

LIBRAIRIE SCIENTIFIQUE-INDUSTRIELLE ET AGRICOLE DE LACROIX-COMON

15, QUAI MALAQUAIS

Paris, Impr. Paul Dupont



**BIBLIOTEKA CYFROWA POLITECHNIKI KRAKOWSKIEJ**

xx  
369

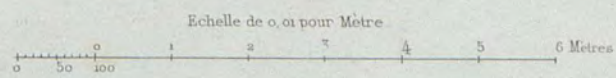
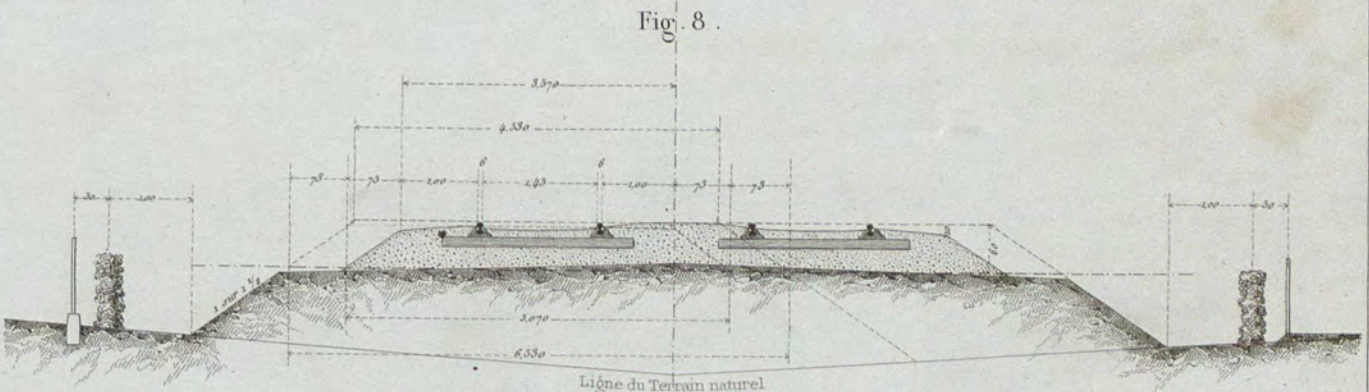
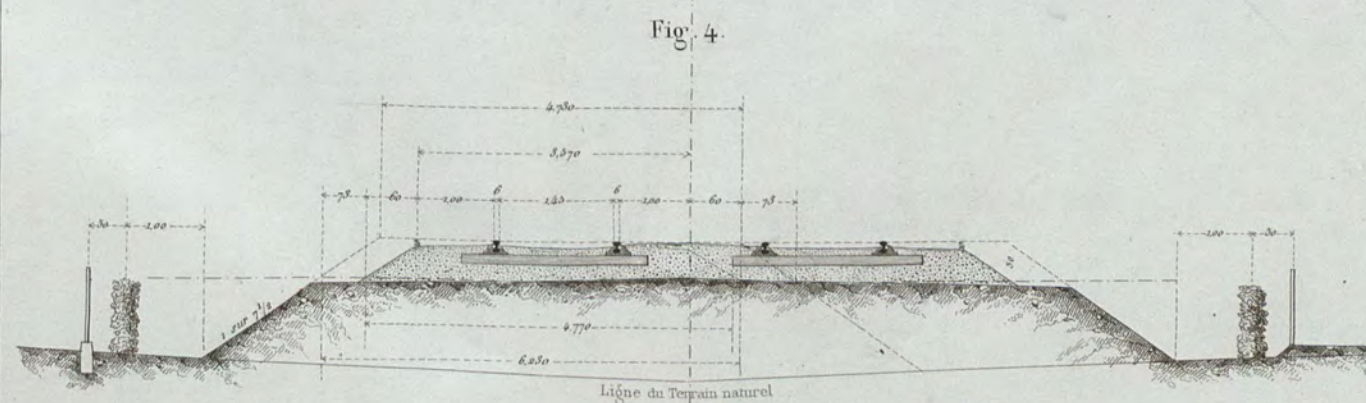
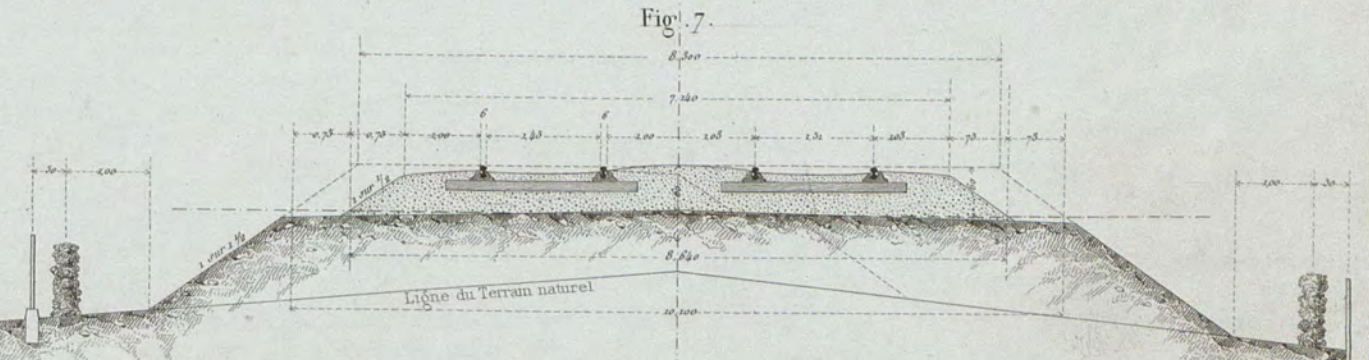
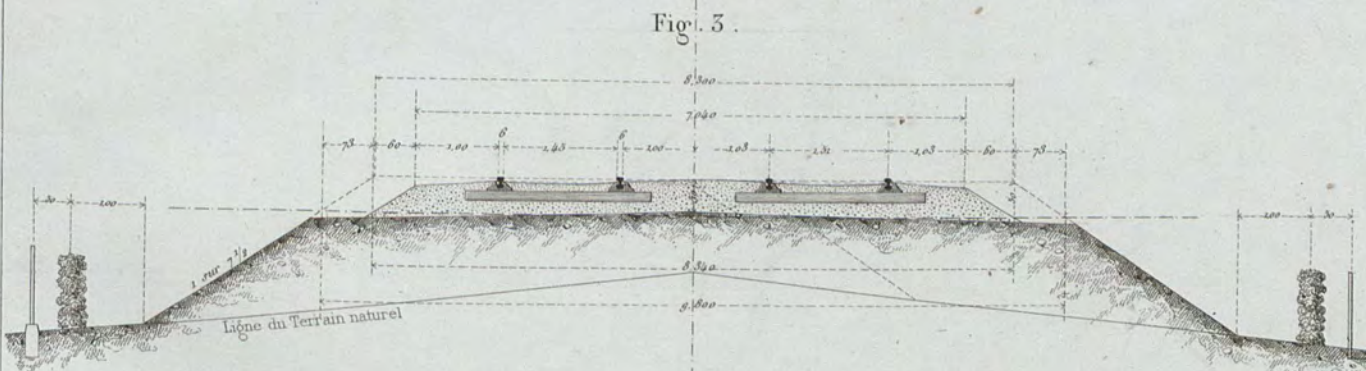
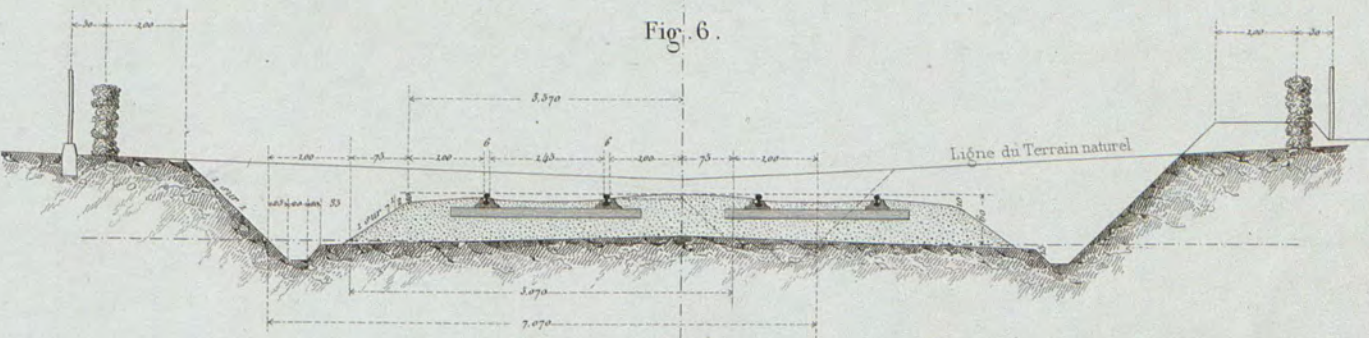
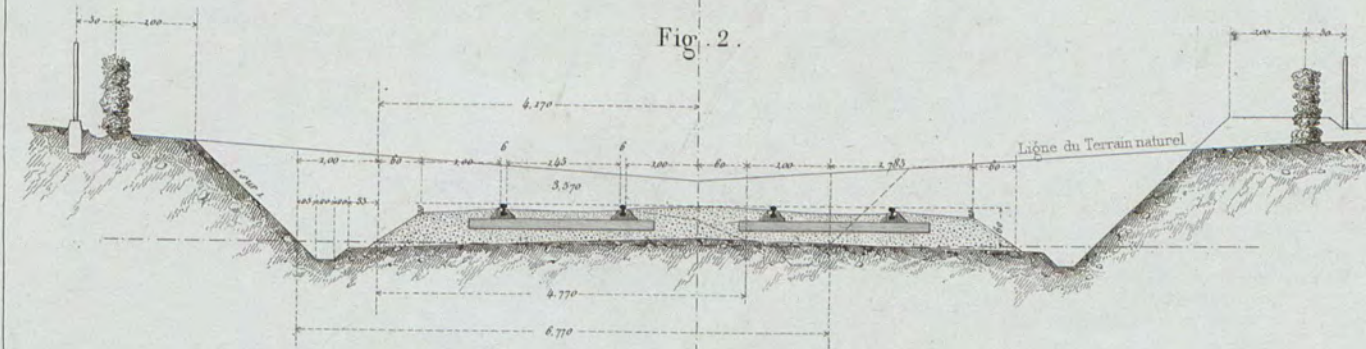
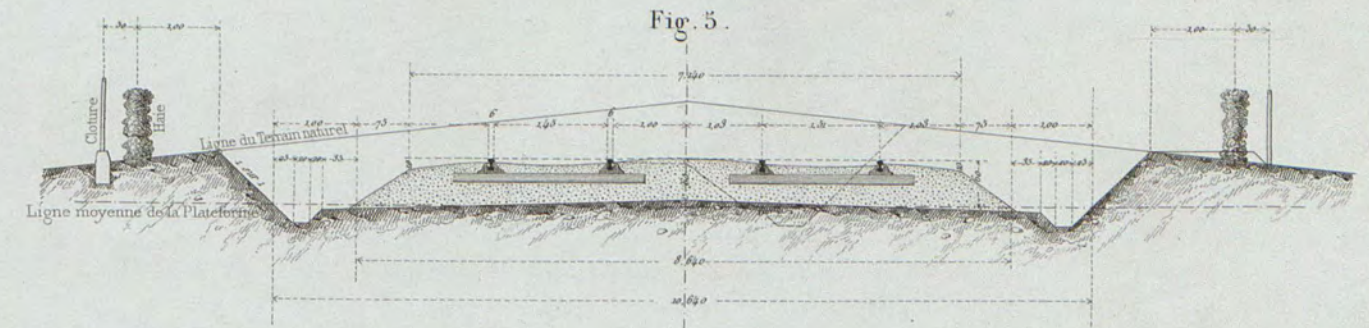
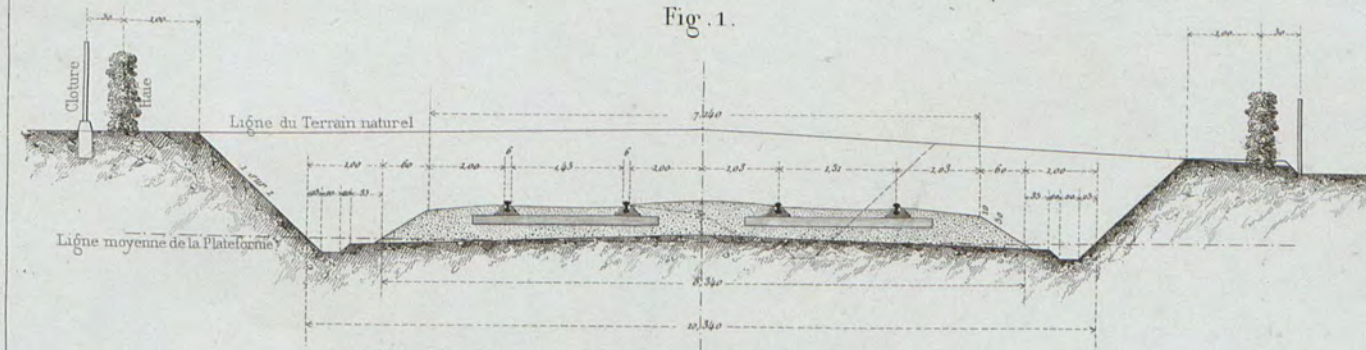

A. Jacquin direx.

Imp. F. Chardon aux Sa. et Manuella Press.

L. Guquet del. et Sc.



Fig. 1. Tranchée du Dockemberg — Elevation.

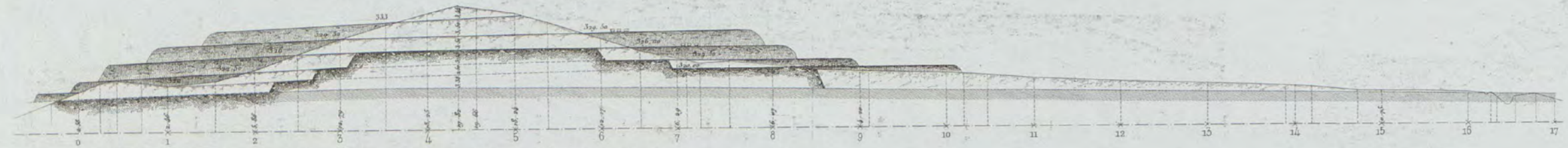

Fig. 3. Coupe géologique de la tranchée du Dockemberg

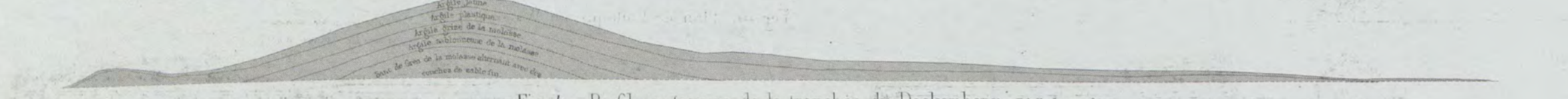

Fig. 4. Profils en travers de la tranchée du Dockemberg. Echelle de 0.0008.

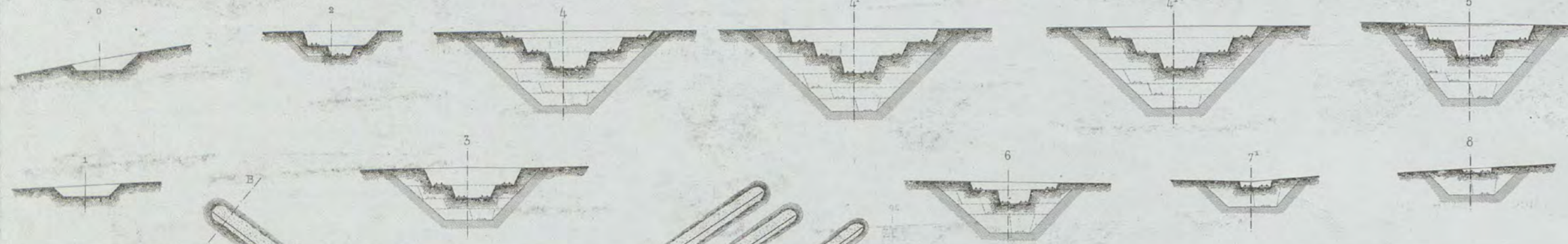

Fig. 2. Plan de la tranchée du Dockemberg.

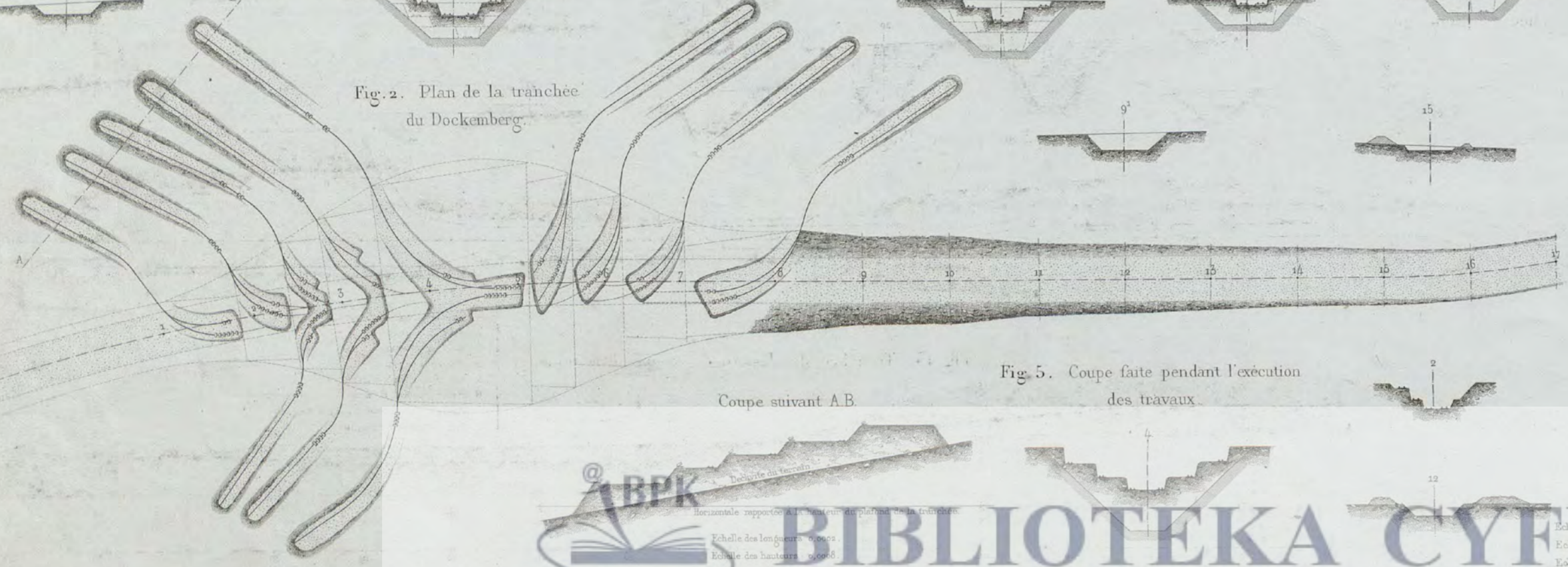

Fig. 5. Coupe faite pendant l'exécution des travaux. Coupe suivant A.B.



Fig. 6. Tranchée de Montaigu — Coupe géologique.

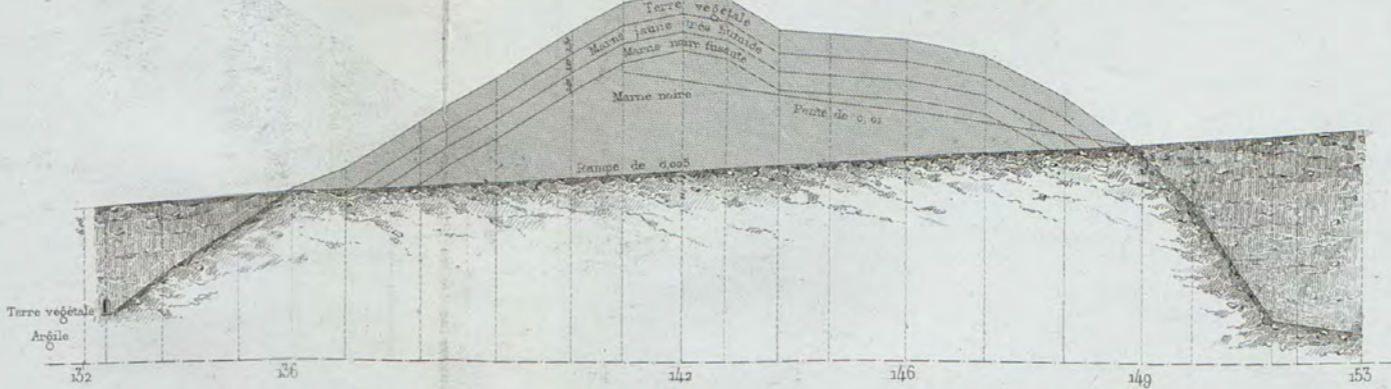

Fig. 7. Plan de la tranchée de Montaigu.

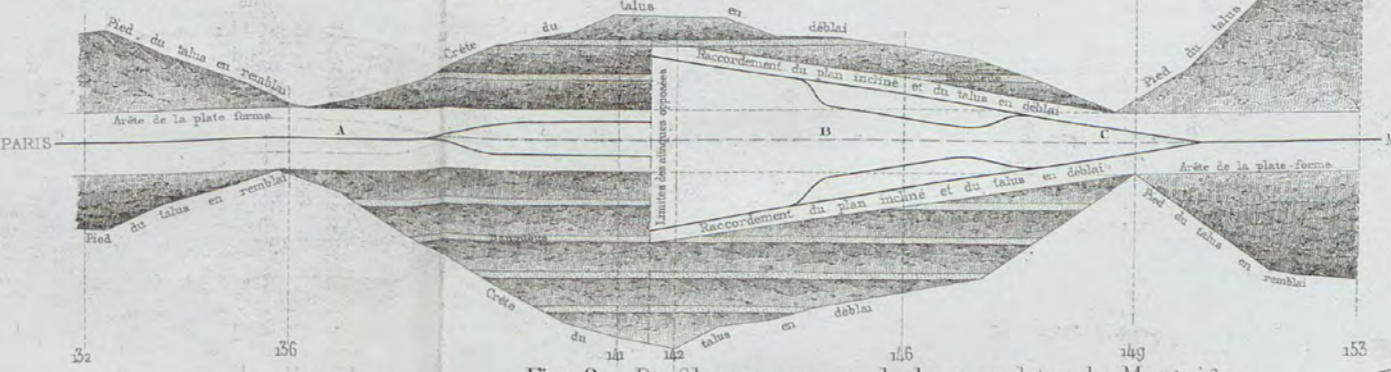

Fig. 8. Profils en travers de la tranchée de Montaigu.

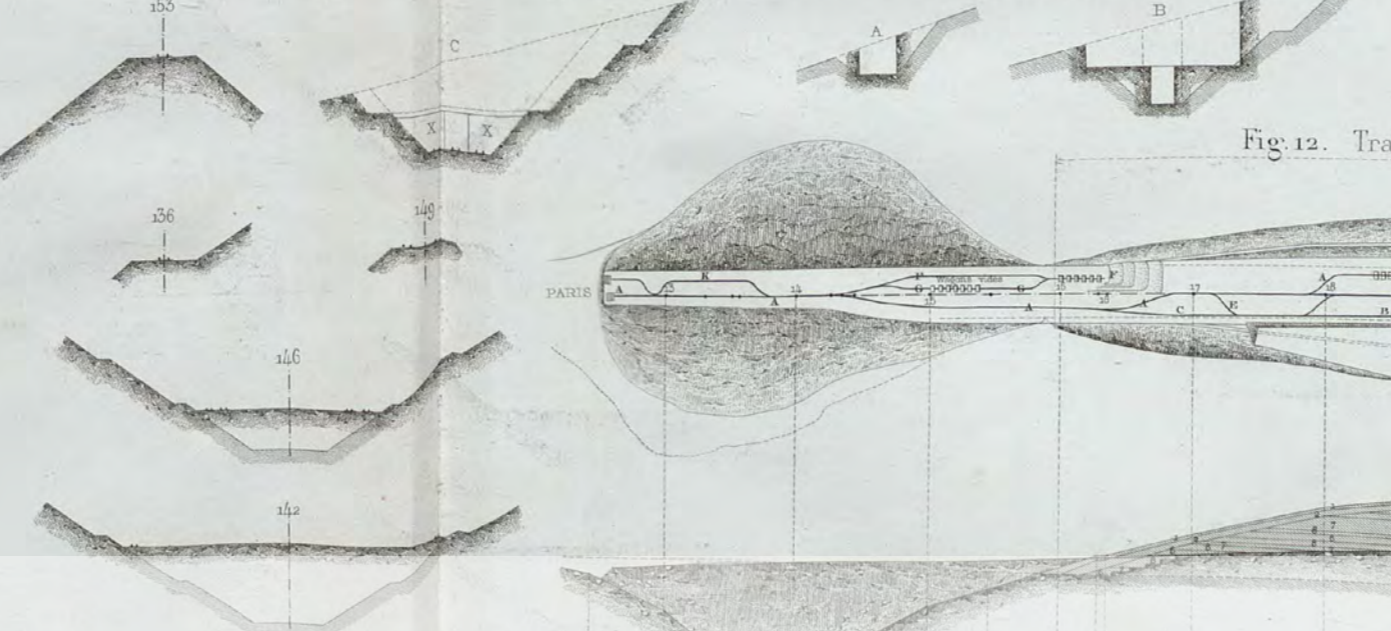

Fig. 9. Tranchée de Jessains. Elevation de l'attaque au Wagonnet.

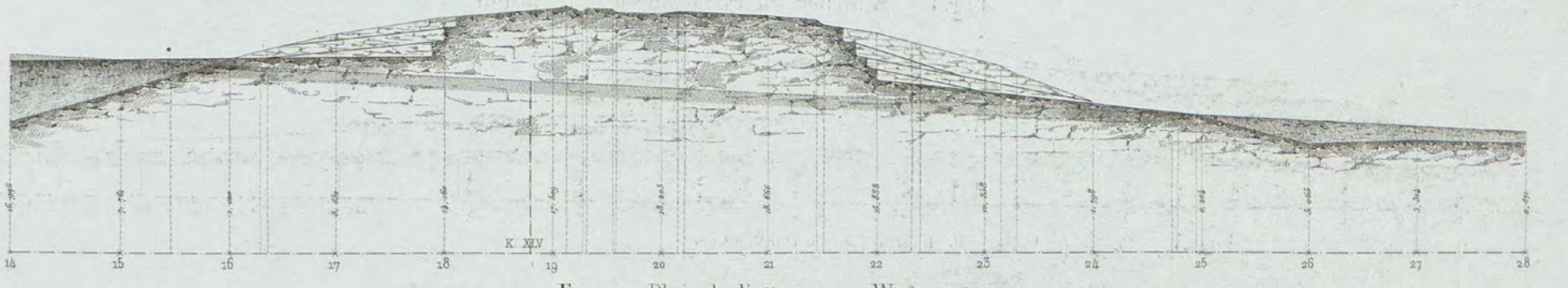

Fig. 10. Plan de l'attaque au Wagonnet

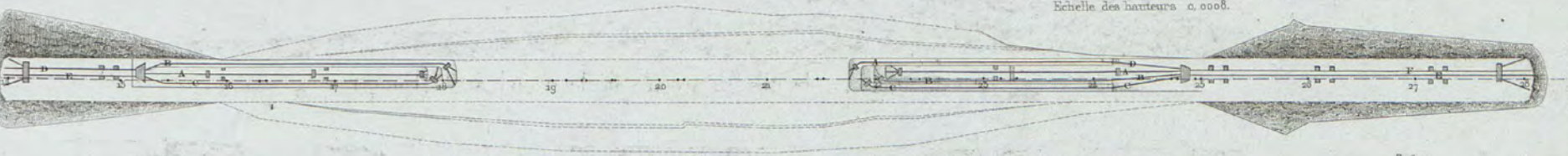

Fig. 11. Profil en travers de la tranchée de Jessains. Echelle de 0.0008.

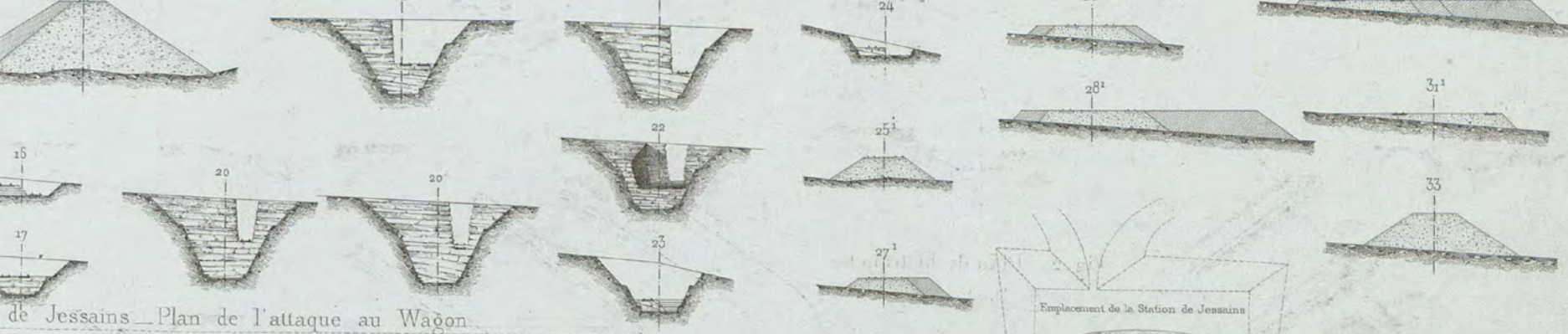

Fig. 12. Tranchée de Jessains — Plan de l'attaque au Wagon.

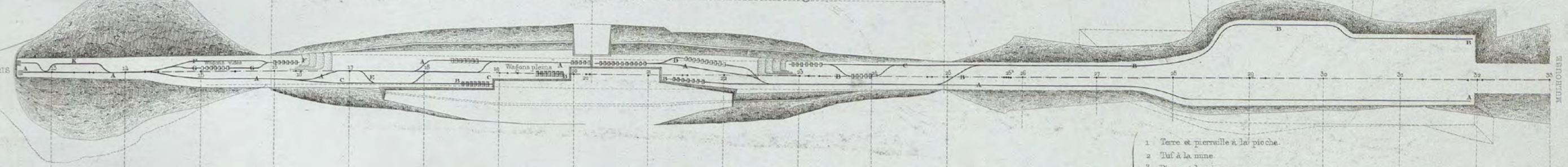
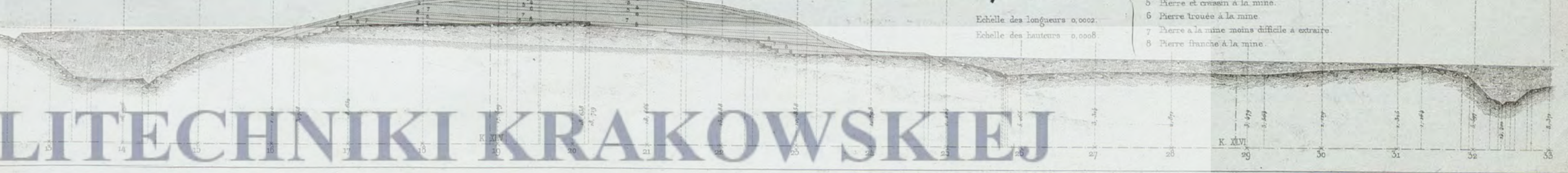

Fig. 13. Tranchée de Jessains — coupe géologique.



BIBLIOTEKA CYFROWA POLITECHNIKI KRAKOWSKIEJ

Fig. 3. Profils en travers Echelle de 0<sup>m</sup> sur.

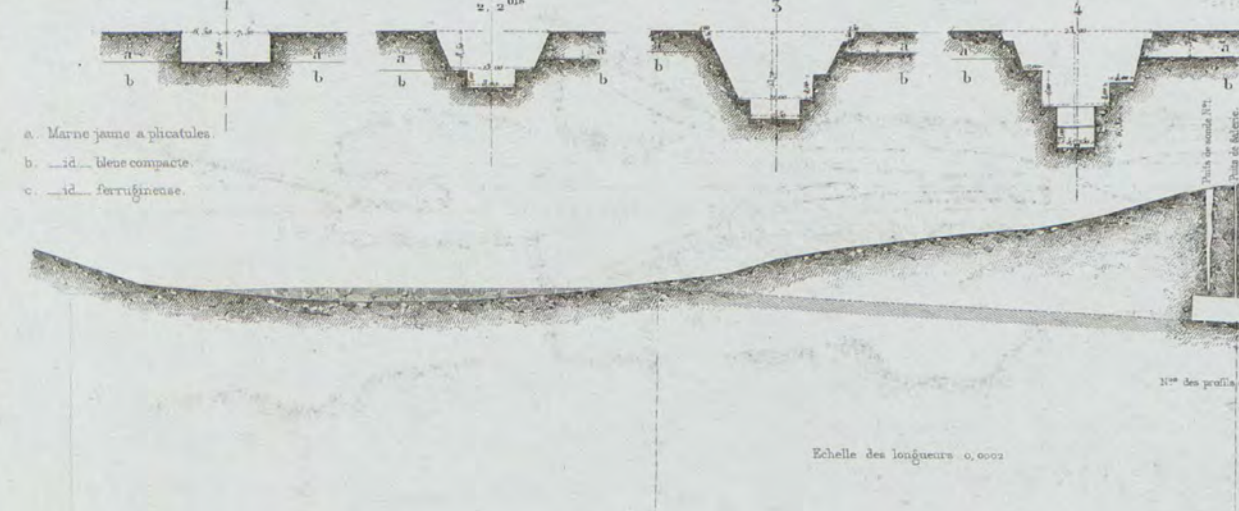

Fig. 1. Tranchée de Charmoille.

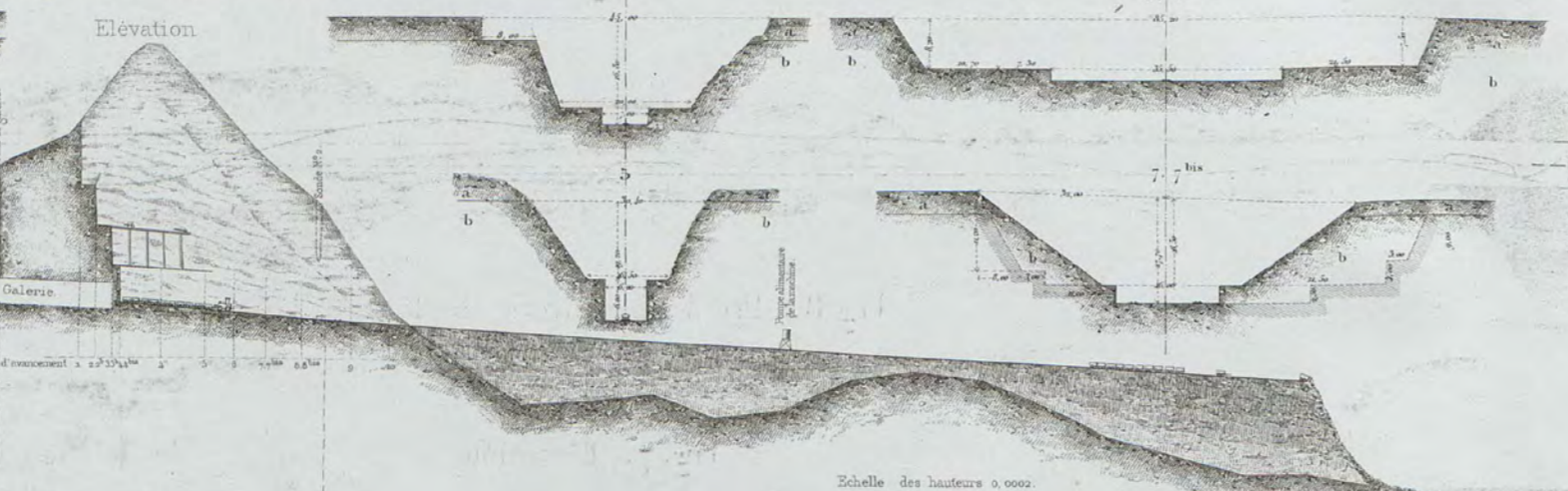

Fig. 5. Profils en travers Echelle de 0<sup>m</sup> sur.

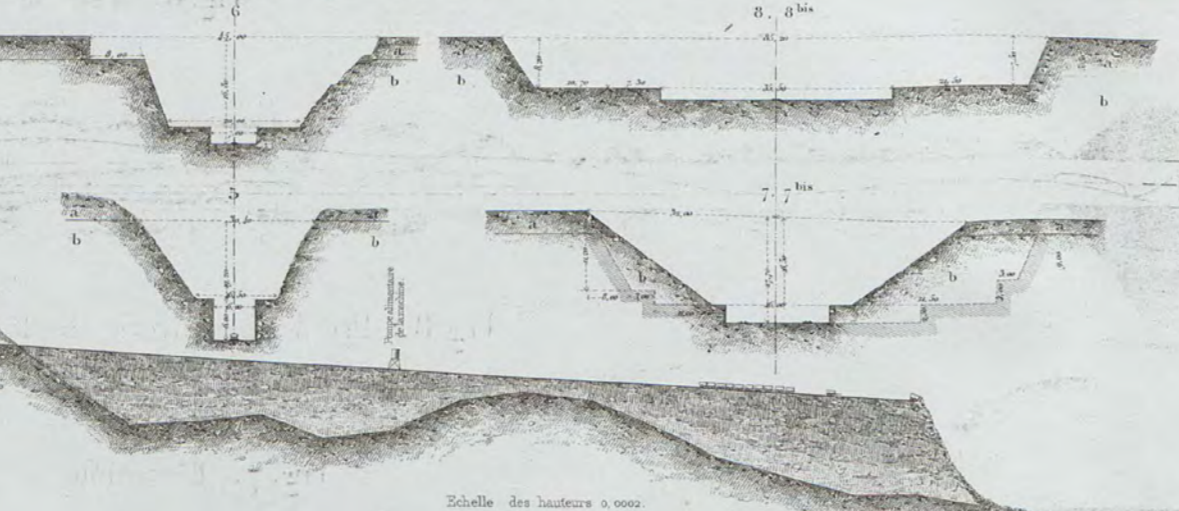

Fig. 6. Plan de la tranchée de Chalmaison.

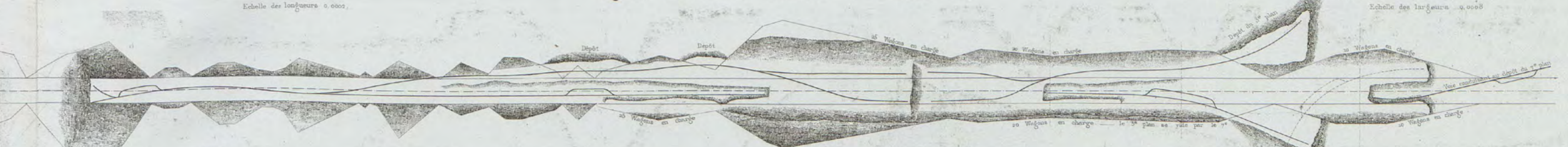

Fig. 8. Profils en travers de la tranchée de Chalmaison.



Fig. 7. Elevation de la tranchée de Chalmaison.

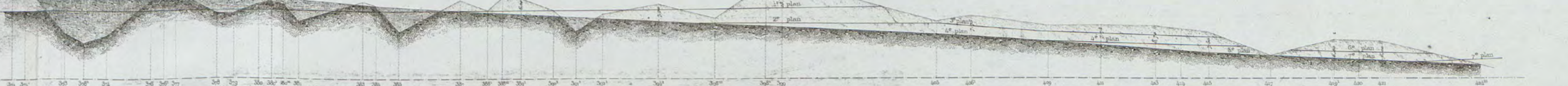

Fig. 2. Plan de la tranchée de Charmoille.

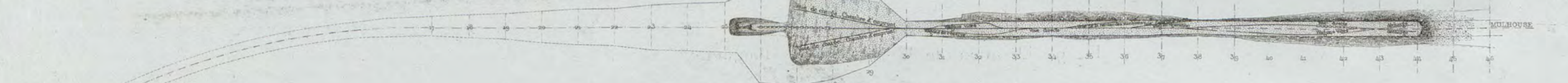

Fig. 9. Elevation de la tranchée de Danjoutin.

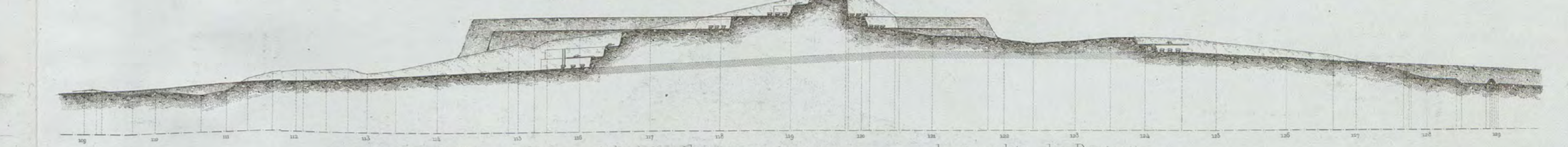

Fig. 4. Elevation de la tranchée de Venduvre.

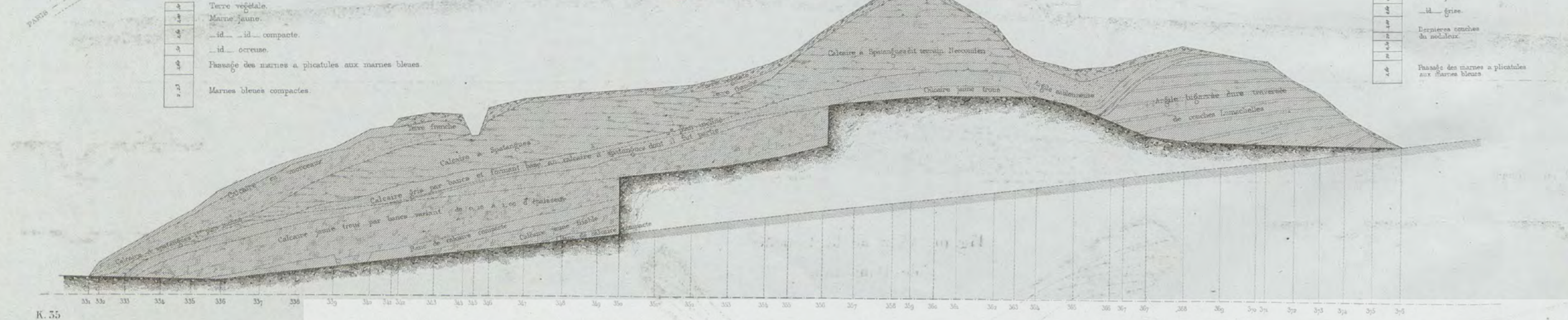

Fig. 11. Coupe géologique de la tranchée de Danjoutin.

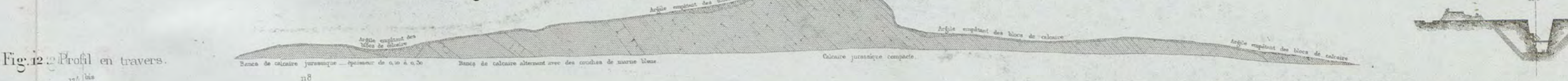

Fig. 12. Profil en travers.



Fig. 10. Plan de la tranchée de Danjoutin.

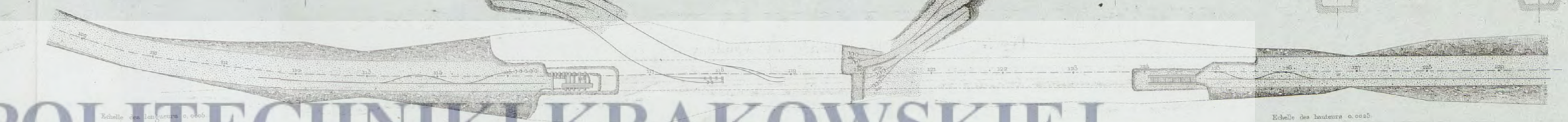
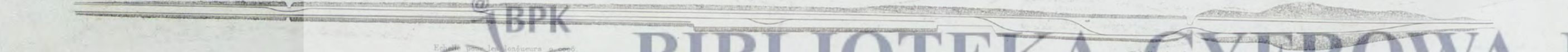
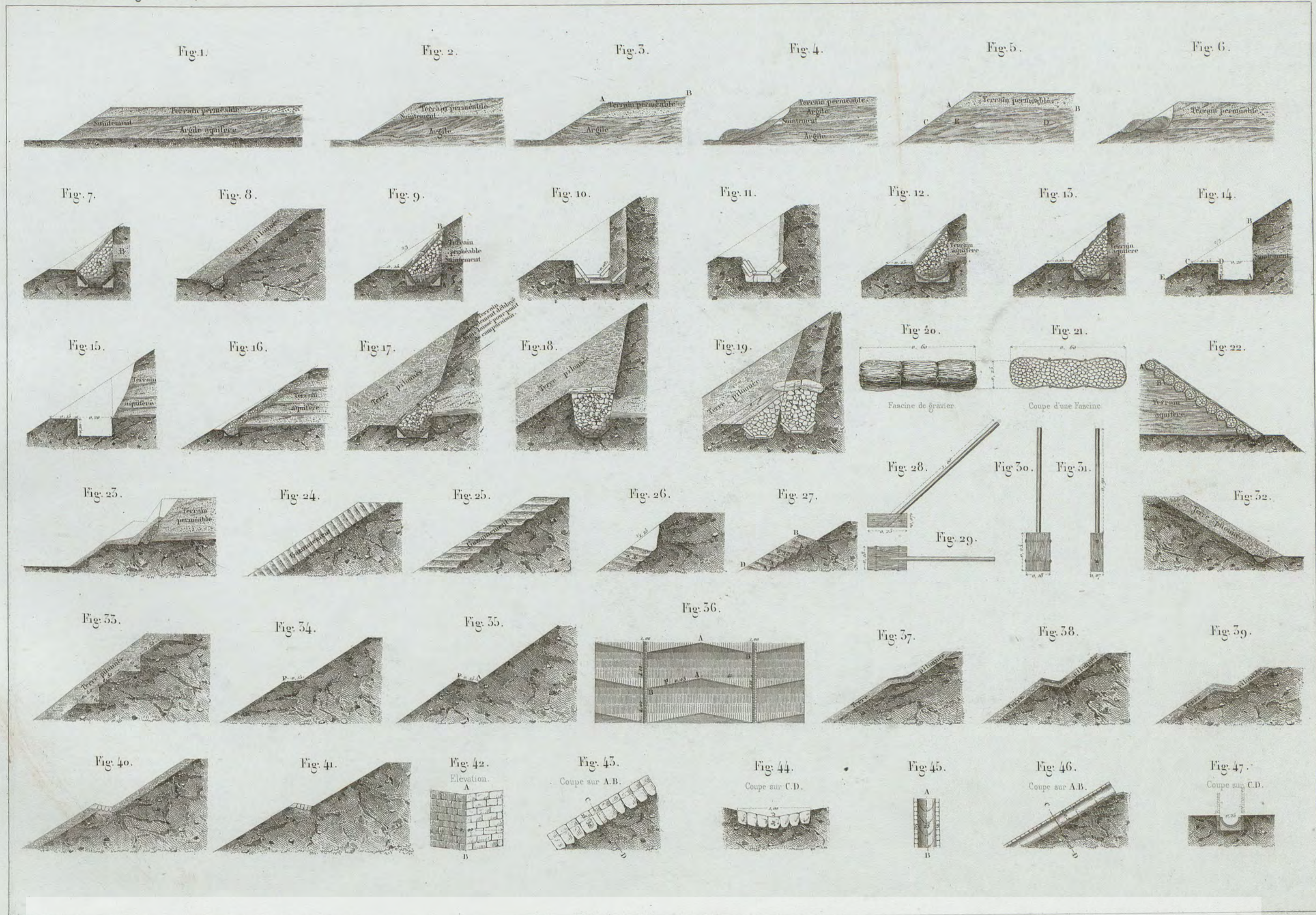

Fig. 12. Profils en travers.



Fig. 5. Plan de la tranchée de Venduvre.





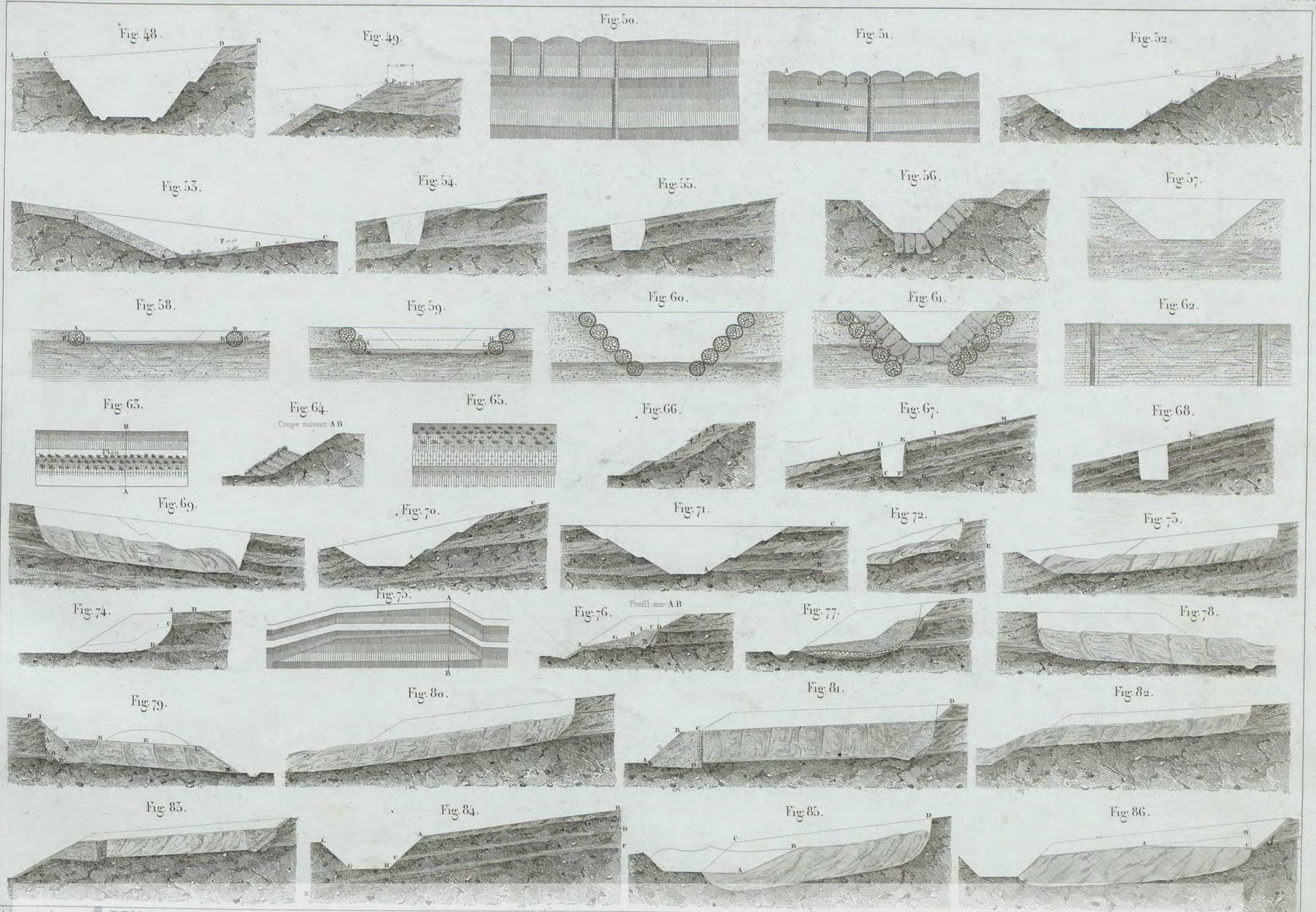

A. Jacquin del.



L. Caignant del. et sc.

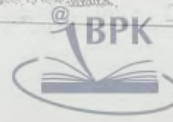
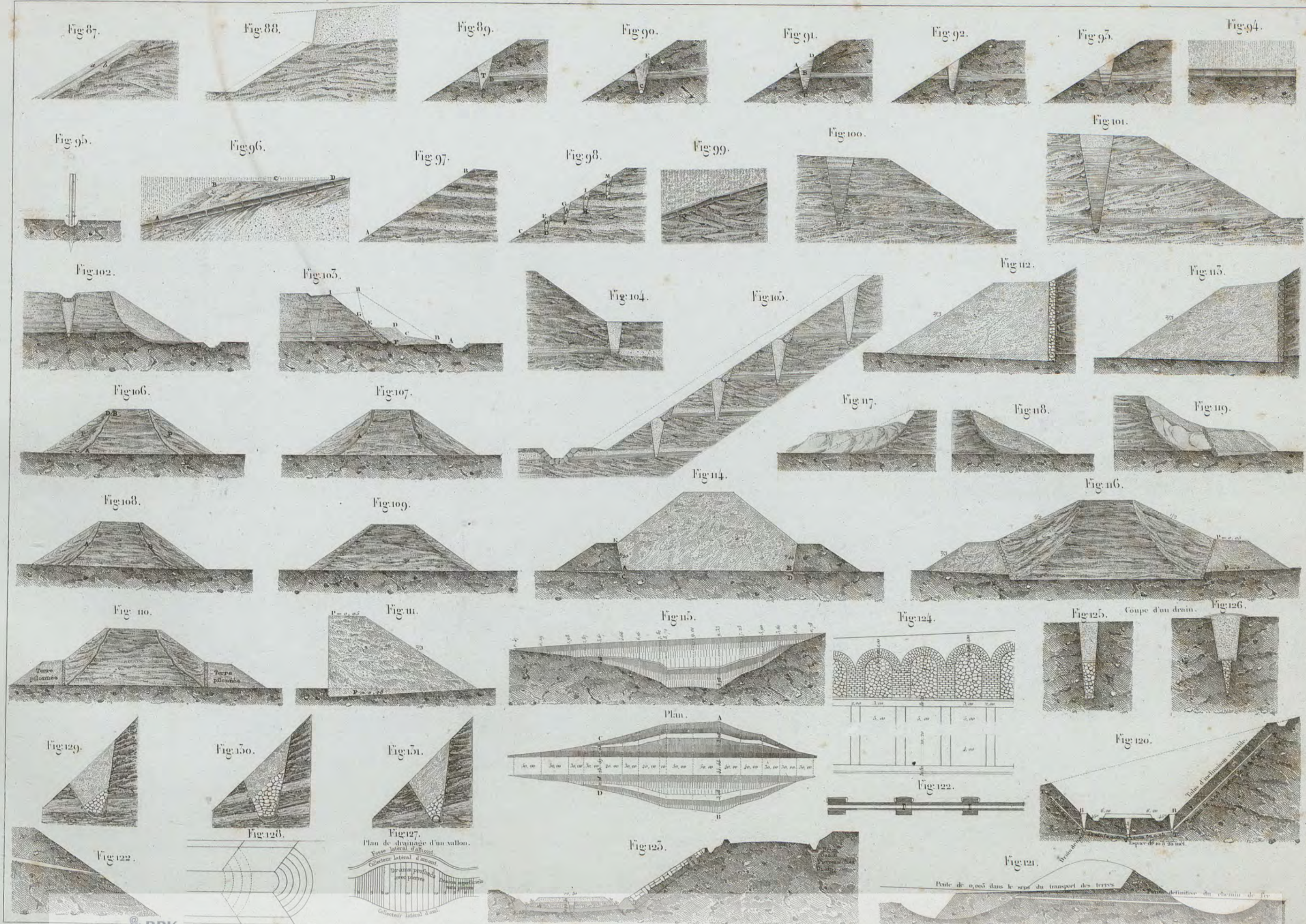

Fig. 1.



Fig. 7.

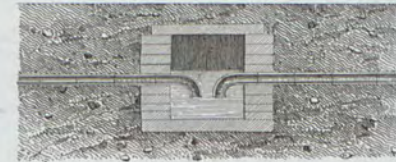

Fig. 14. Coupe C.D.

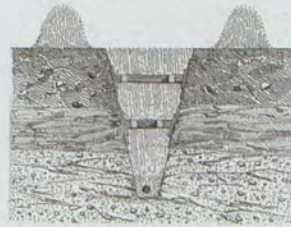

Fig. 15. Coupe A.B.

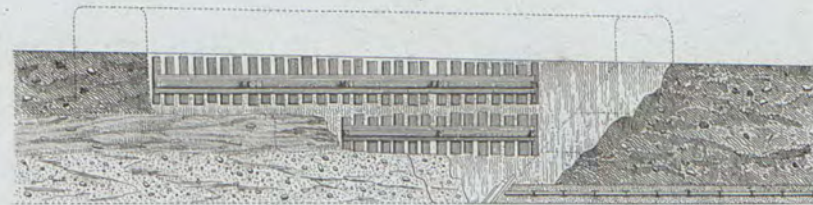

Fig. 5.



Fig. 2.



Fig. 3.

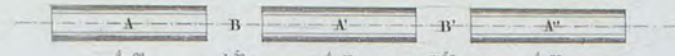

Fig. 9. Profil A.B. (Petit-croix).



Fig. 12. Plan (Petit-croix).

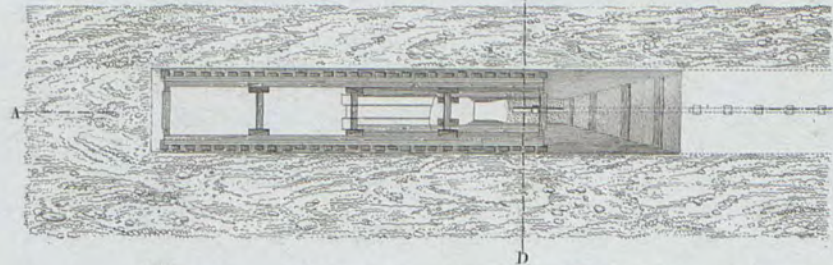

Fig. 11. Profil en long de la tranchée de Petit-Croix.

Fig. 8.

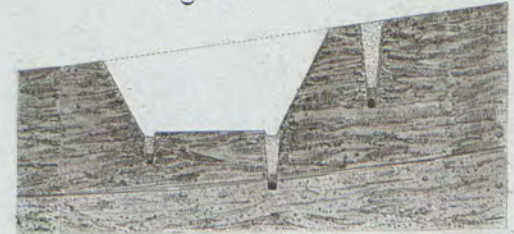

Fig. 4.

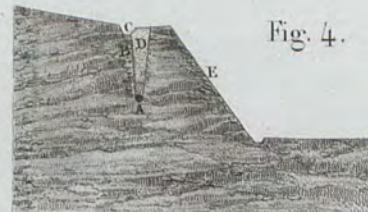

Fig. 15.



Fig. 10. Petit-croix.



Fig. 16.



Fig. 6.

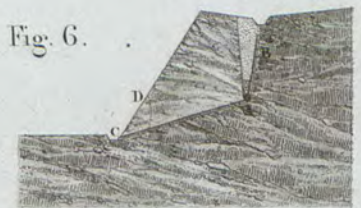

Fig. 18. Dockenberg.



Fig. 25. Dockenberg.



Fig. 22. Dockenberg.



Fig. 17.



Fig. 19. Dockenberg.

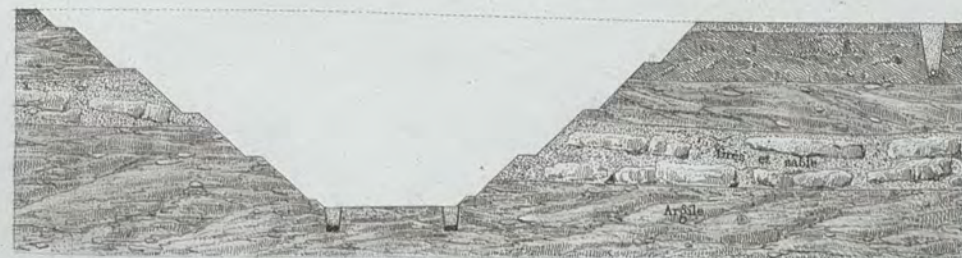

Fig. 20. Dockenberg.



Fig. 21. Dockenberg.

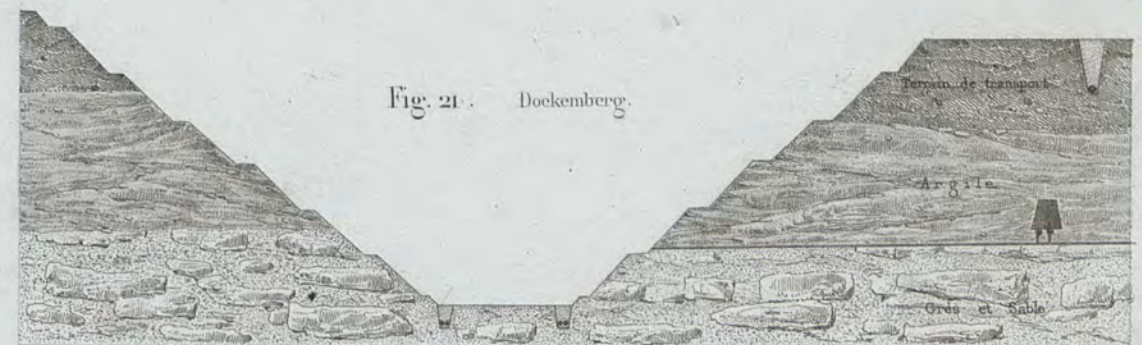
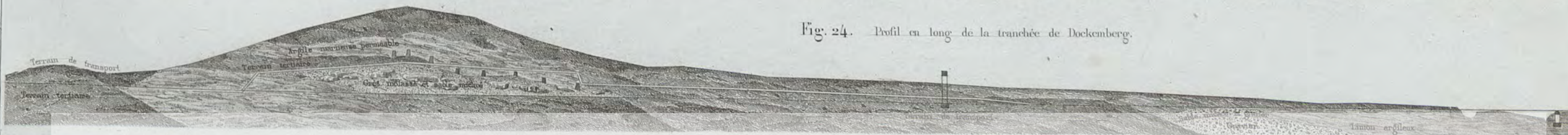
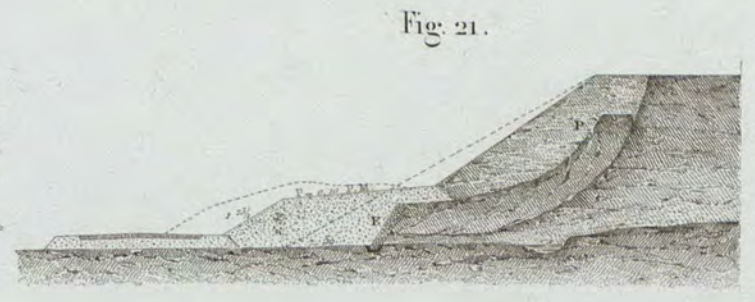
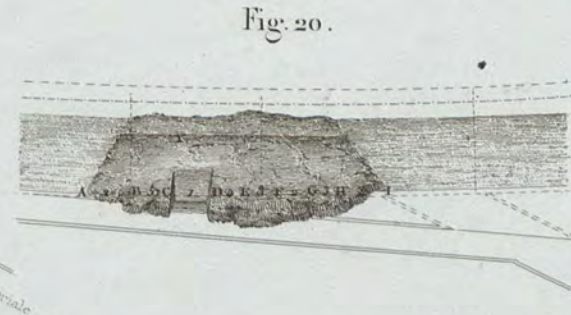
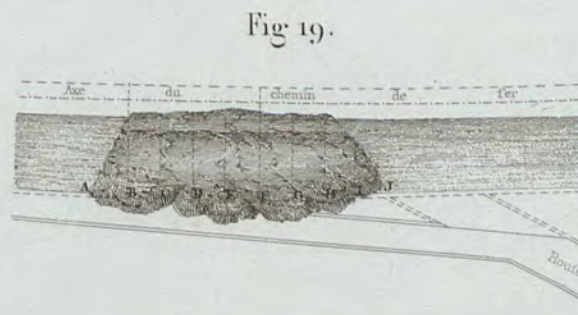
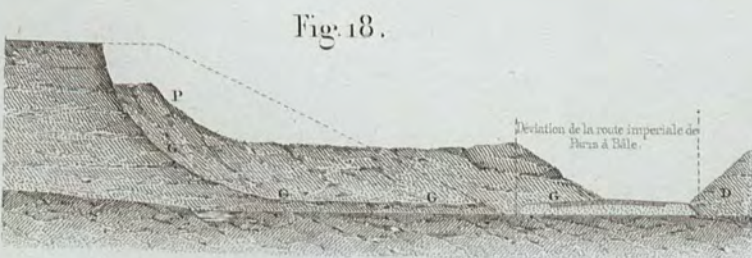
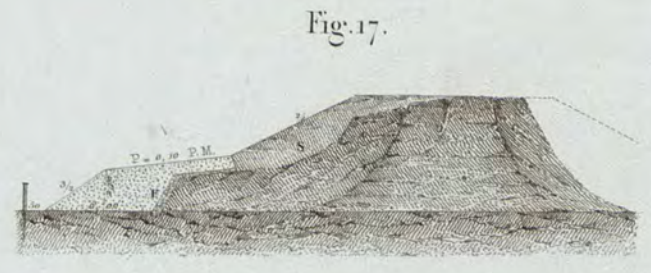
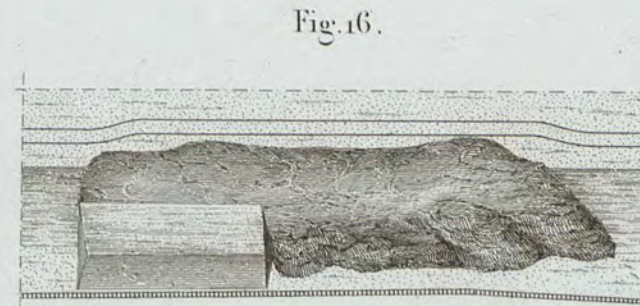
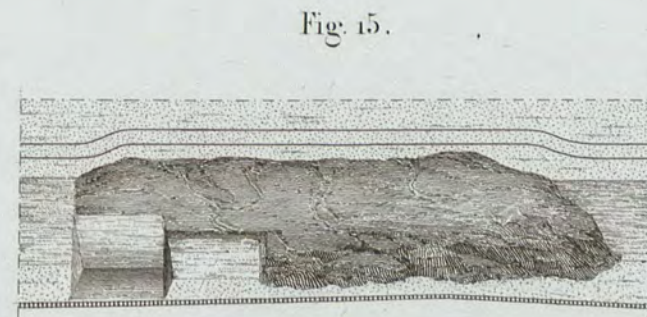
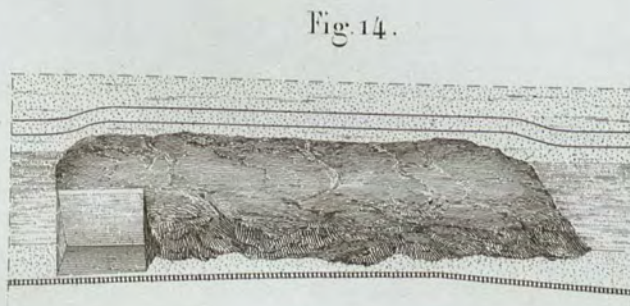
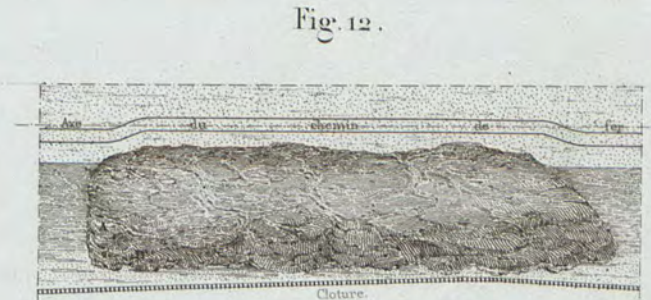
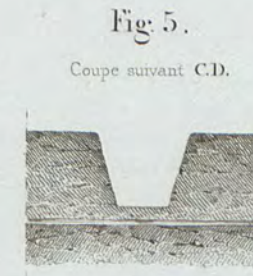
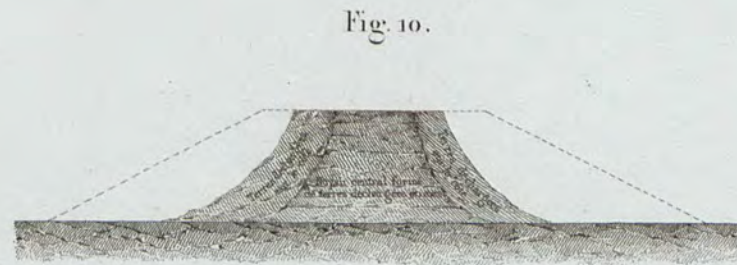
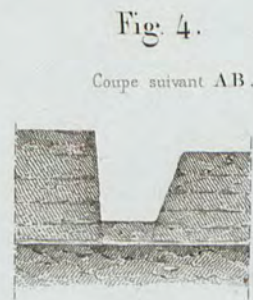
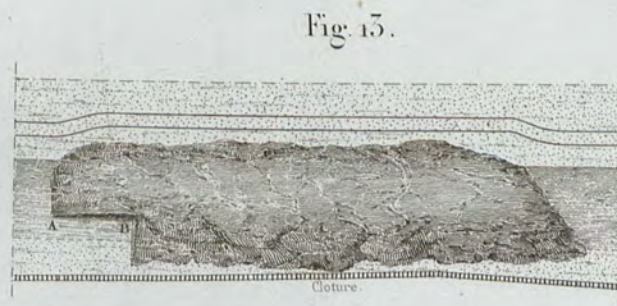
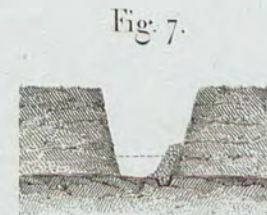
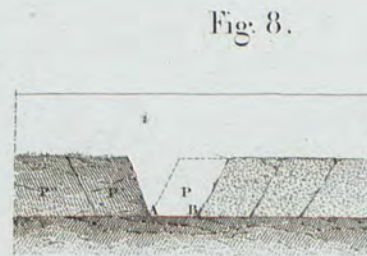
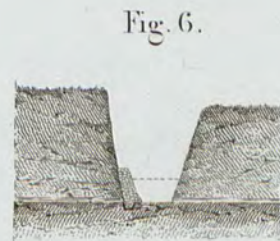
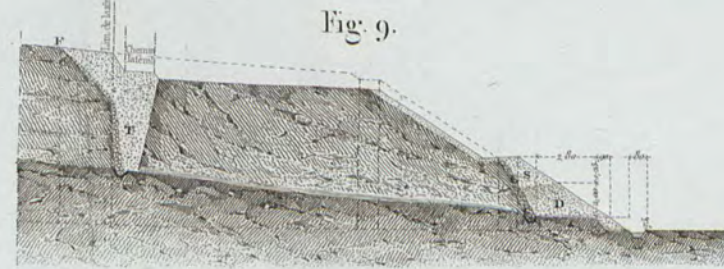
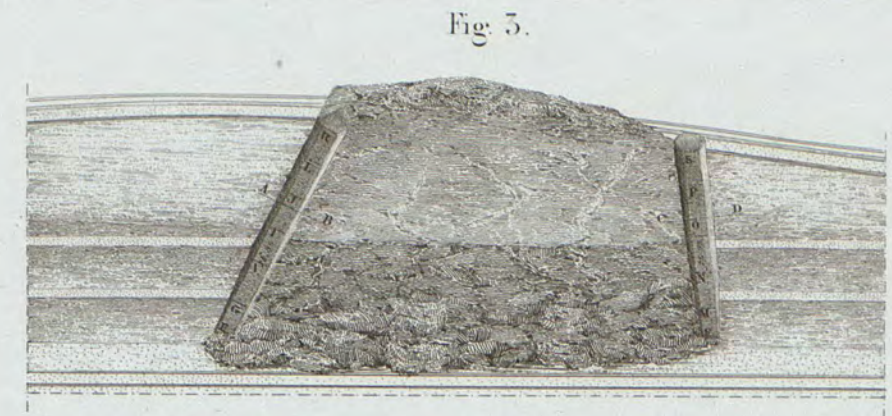
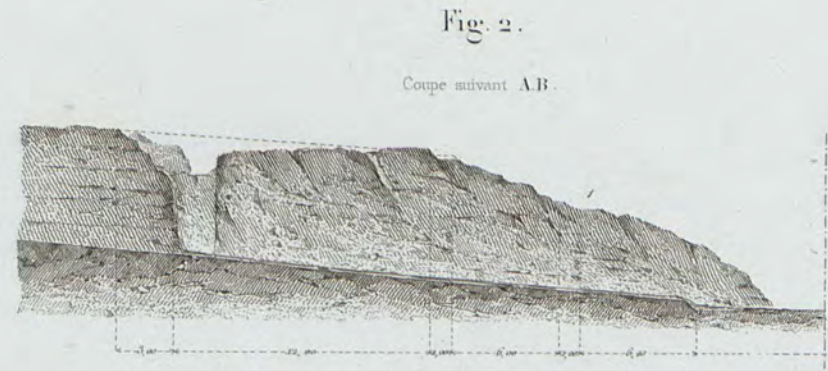
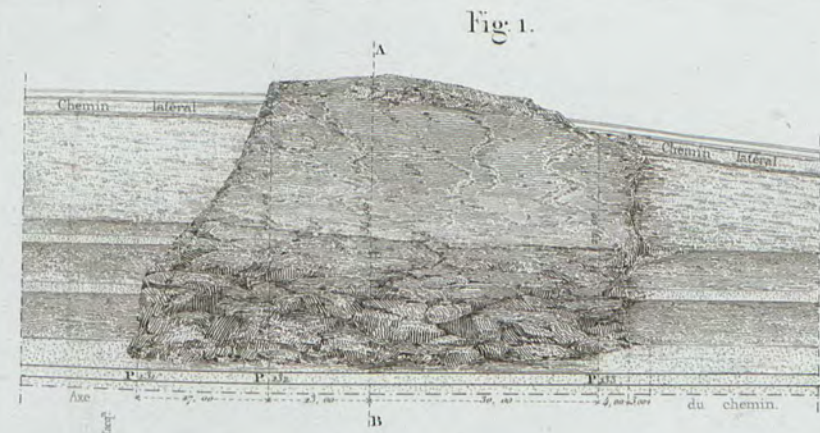
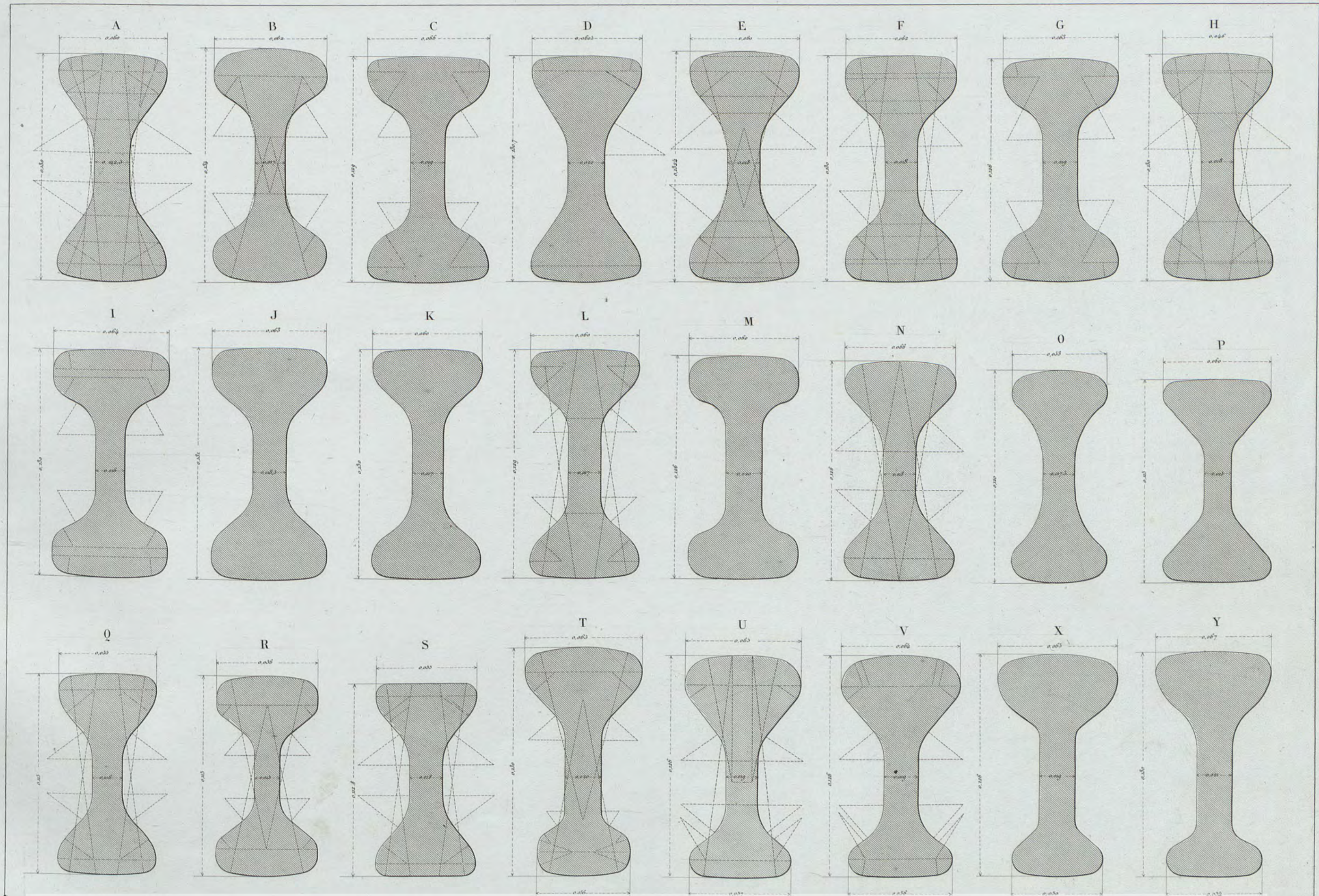

Fig. 24. Profil en long de la tranchée de Dockenberg.









Echelle de 0.50 pour 1 Metre

A. Jacquin dir.

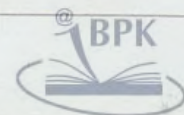

L. Guénet del. et sc.

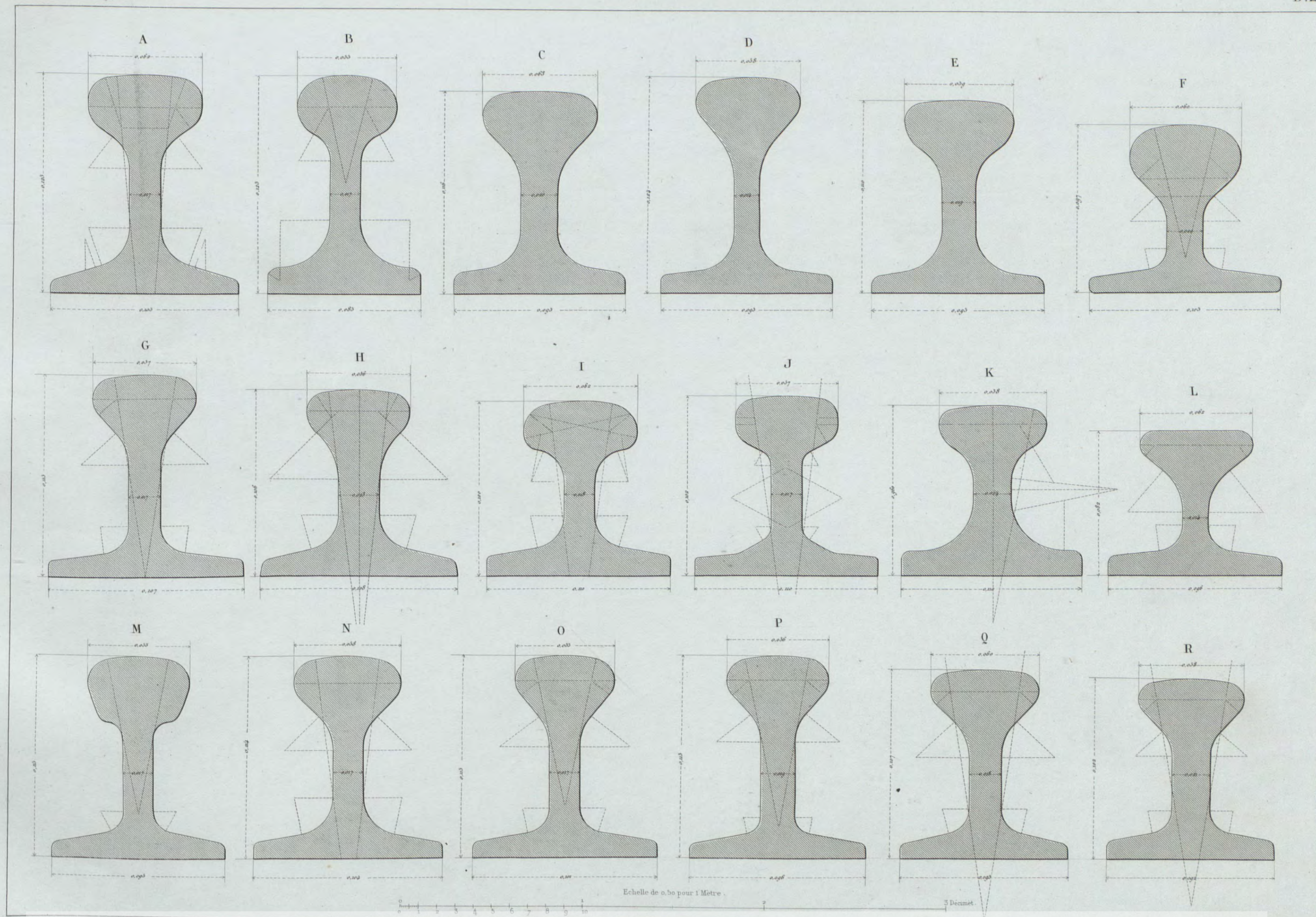

A. Jacquin del.

L. Guénet del. et Sc.



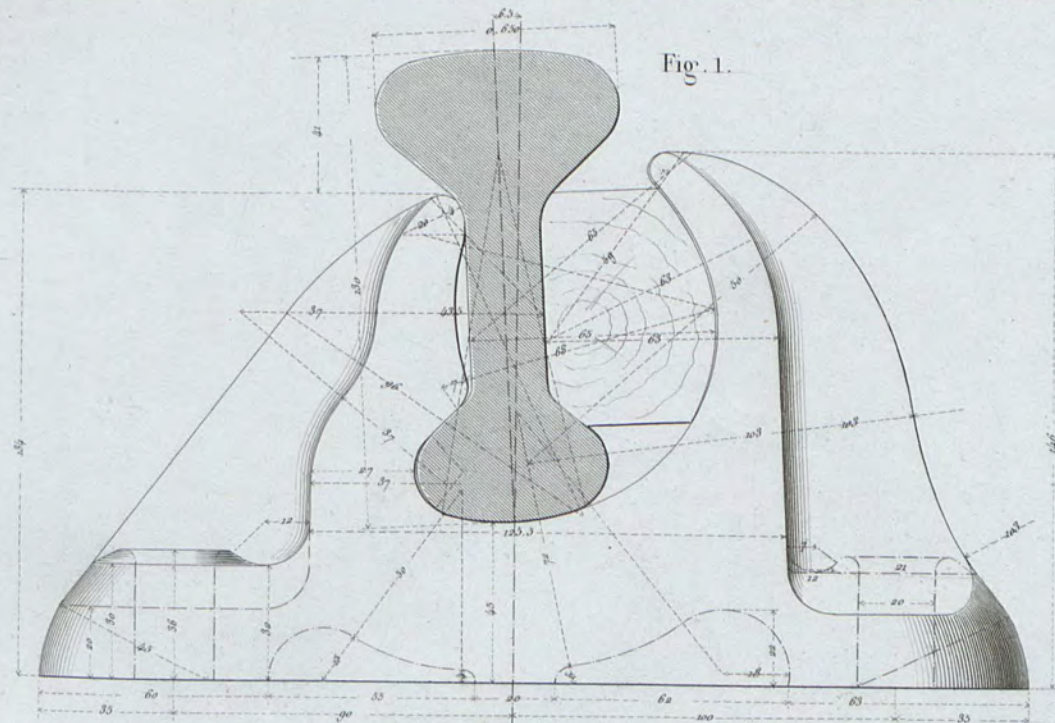

Fig. 1.

Fig. 1.<sup>1</sup>

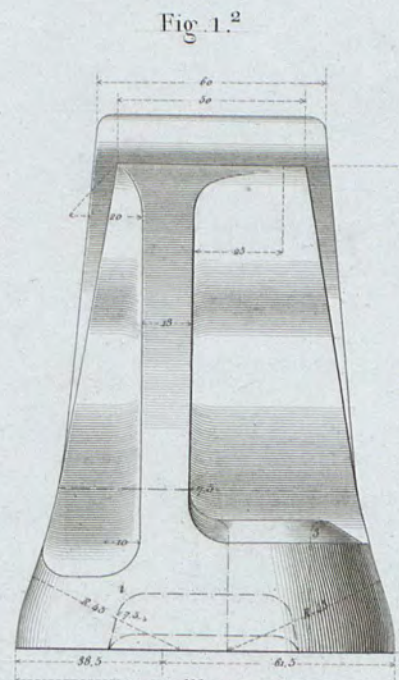

Fig. 1.<sup>2</sup>

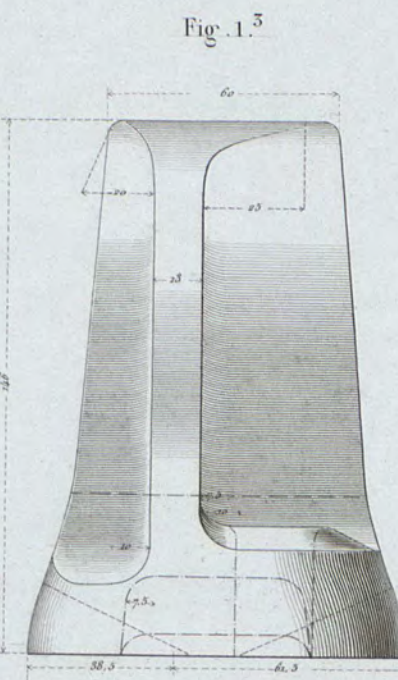

Fig. 1.<sup>3</sup>

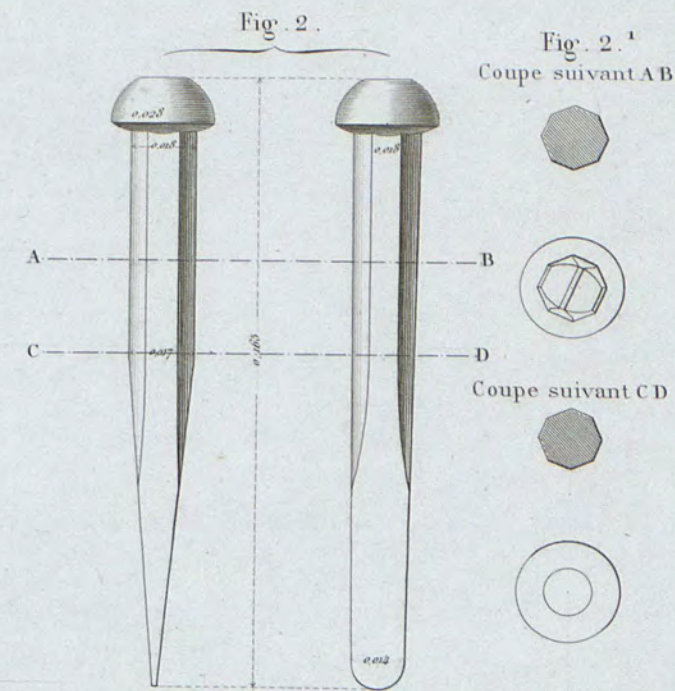
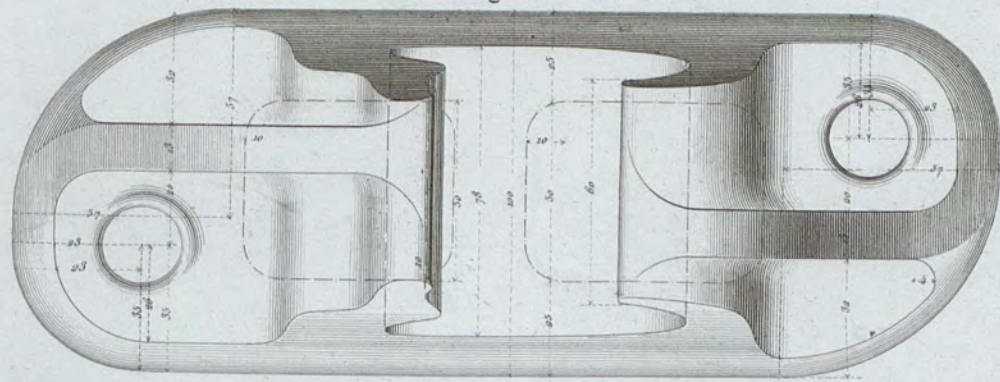

Fig. 2.

Fig. 2.<sup>1</sup>  
Coupe suivant AB

Coupe suivant CD

Fig. 3.<sup>1</sup>



Coupe suivant AB

Fig. 5.

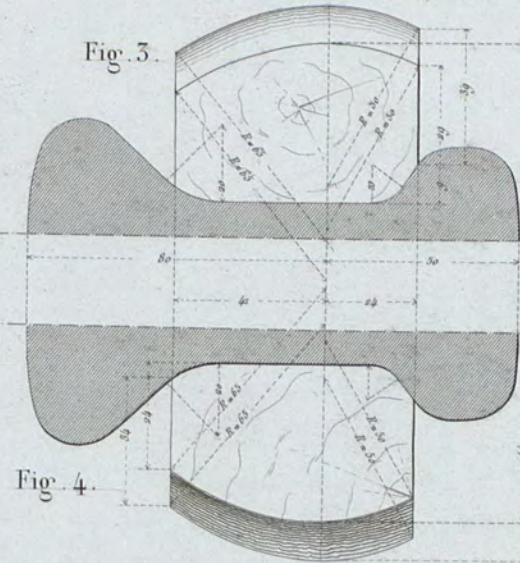

Fig. 3.

Fig. 4.

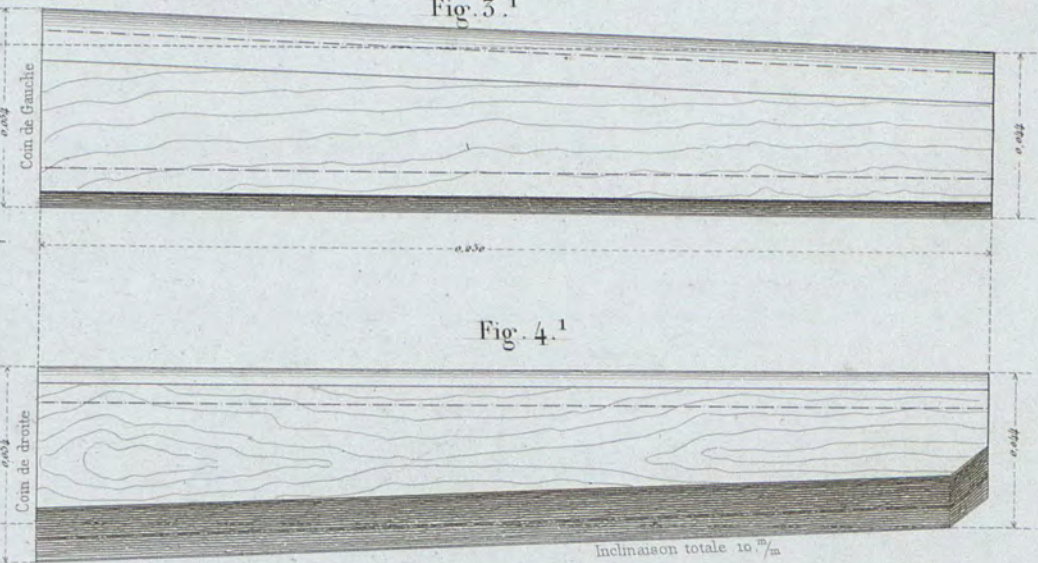

Fig. 4.<sup>1</sup>

Inclinaison totale 10<sup>m</sup>/m

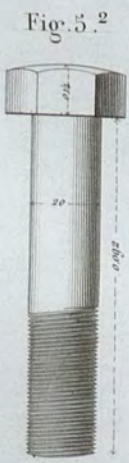

Fig. 5.<sup>2</sup>



Fig. 5.<sup>3</sup>

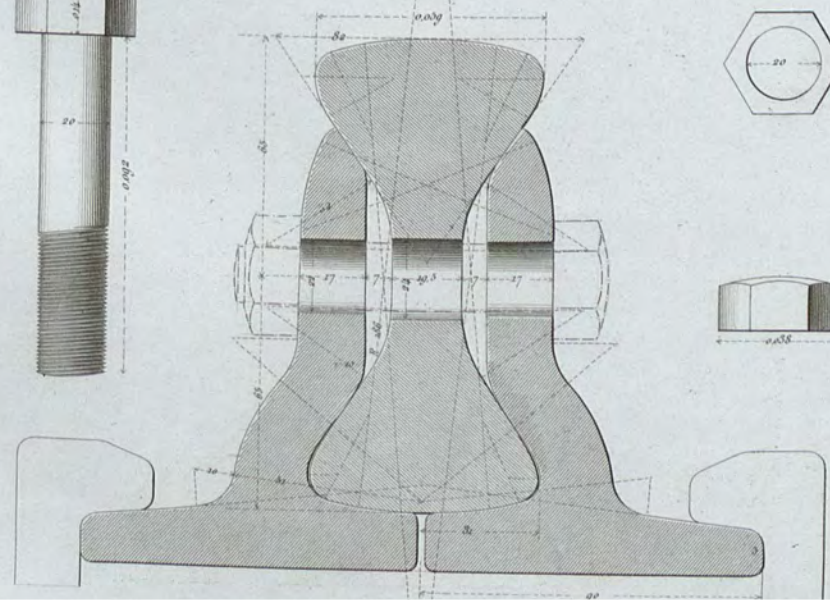
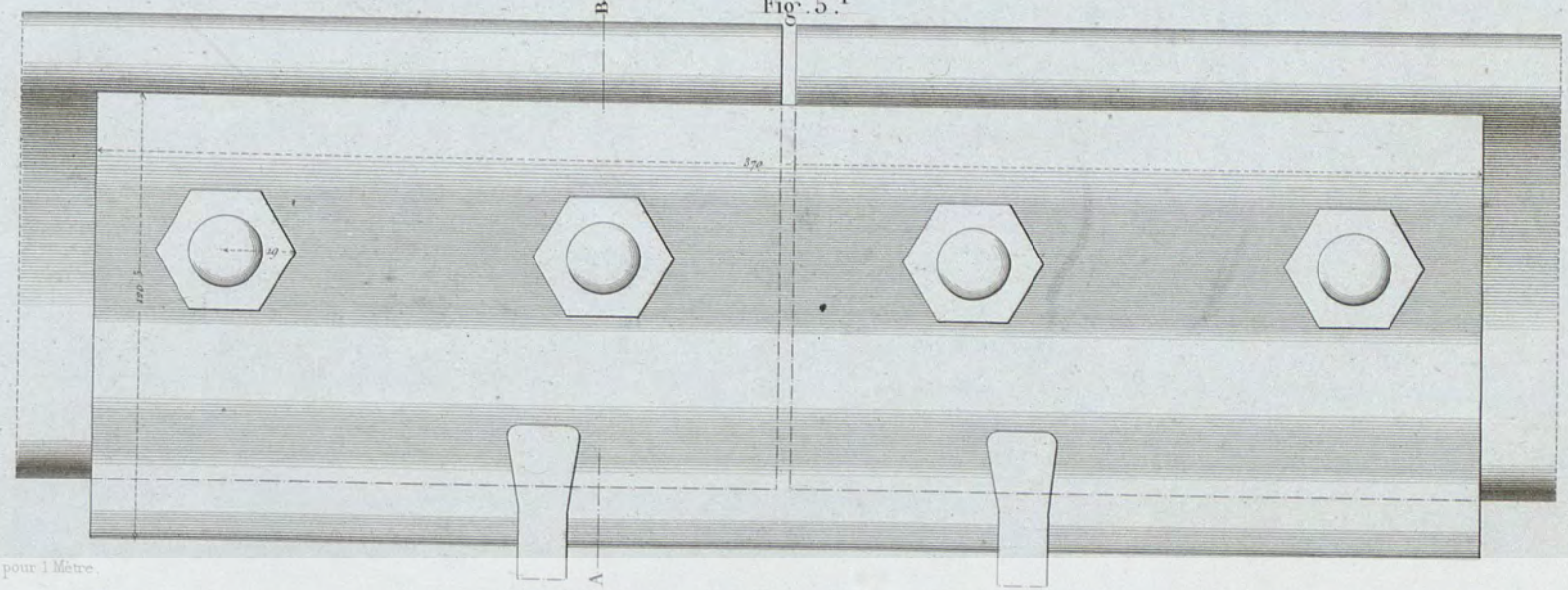

Fig. 5.<sup>1</sup>



Echelle 0.50 pour 1 Mètre.

A. Jacquin. dir.

Exp. F. Chardon. ind. et Manuf. Paris.

L. Gunguet del. et Sc.



Fig. 1.

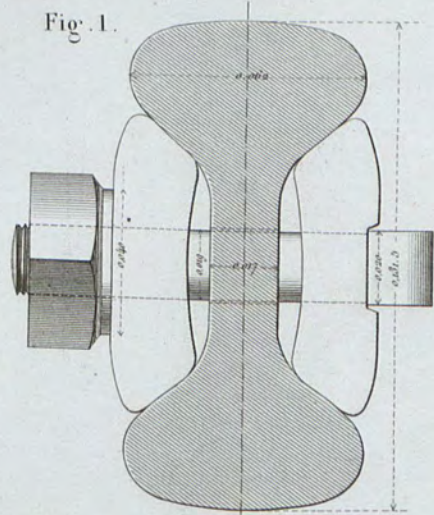

Fig. 1.<sup>1</sup>

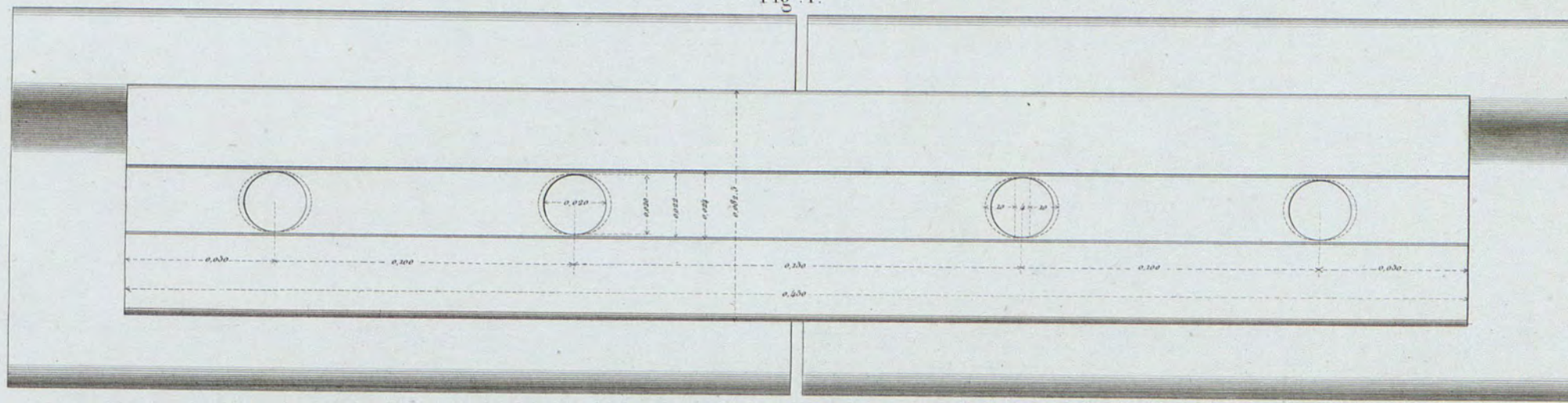

Fig. 1.<sup>3</sup>

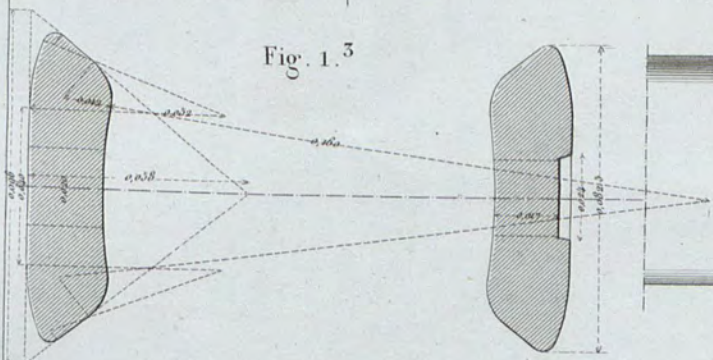

Fig. 1.<sup>2</sup>

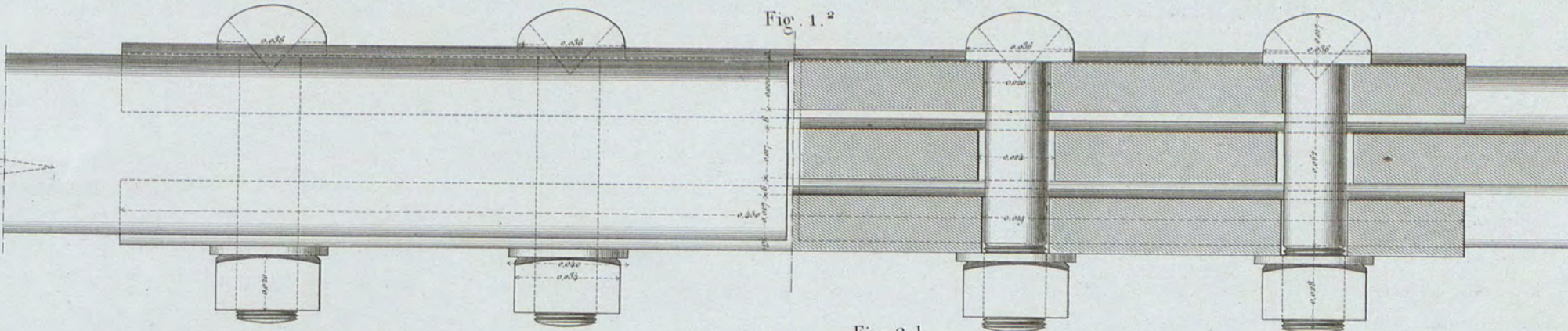

Fig. 2.

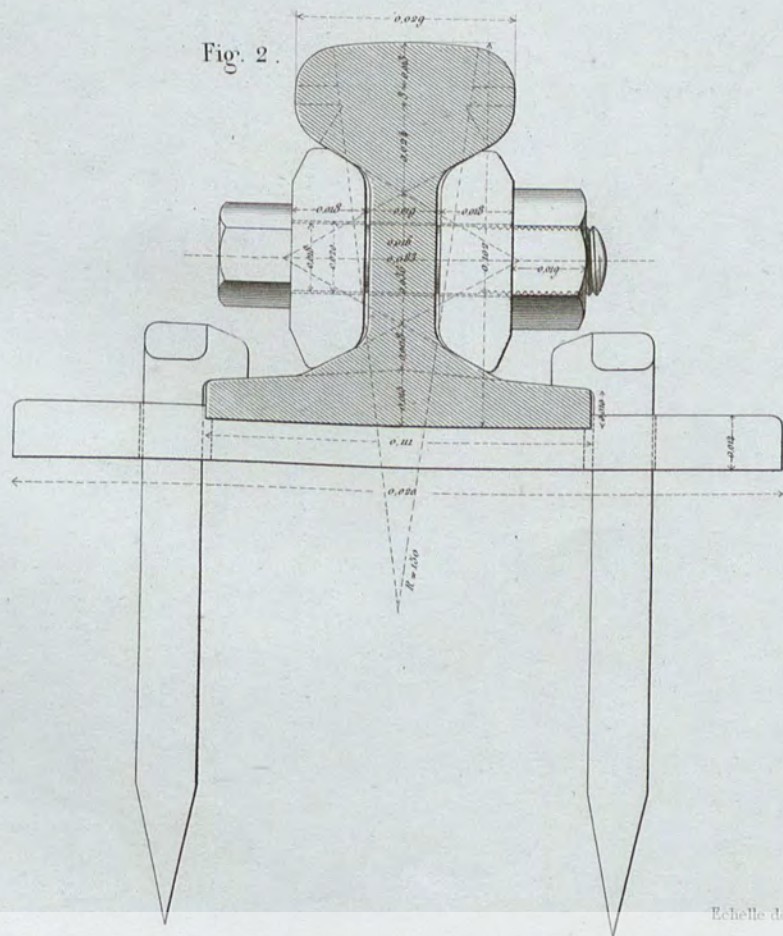

Fig. 2.<sup>1</sup>

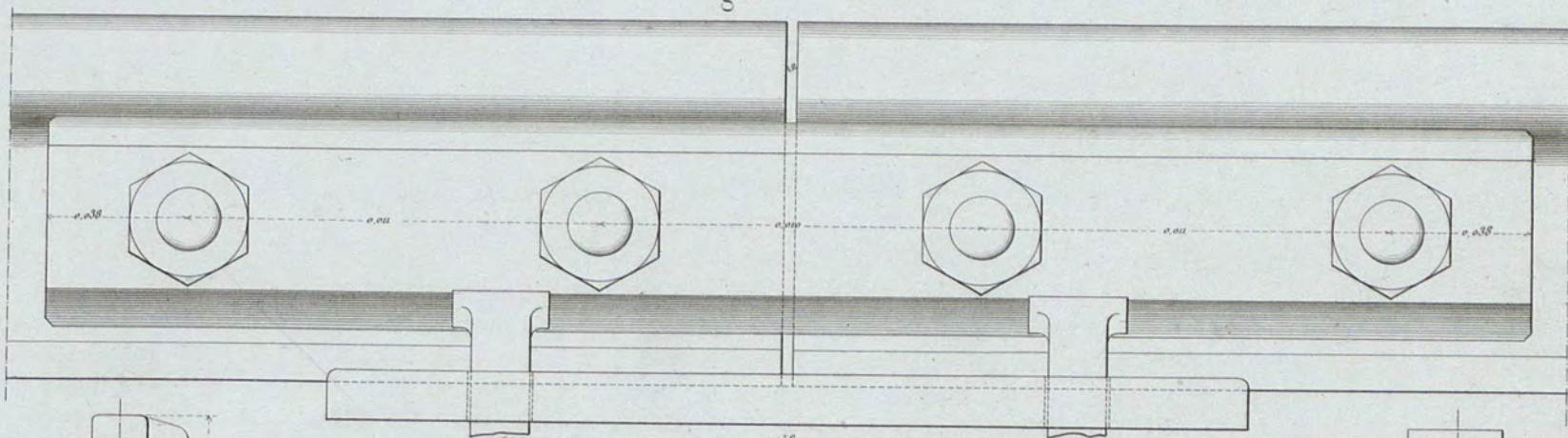

Fig. 2.<sup>3</sup>

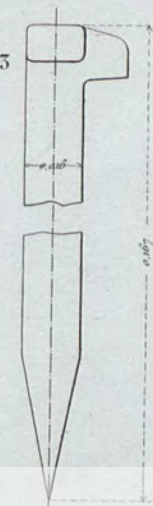

Fig. 2.<sup>2</sup>

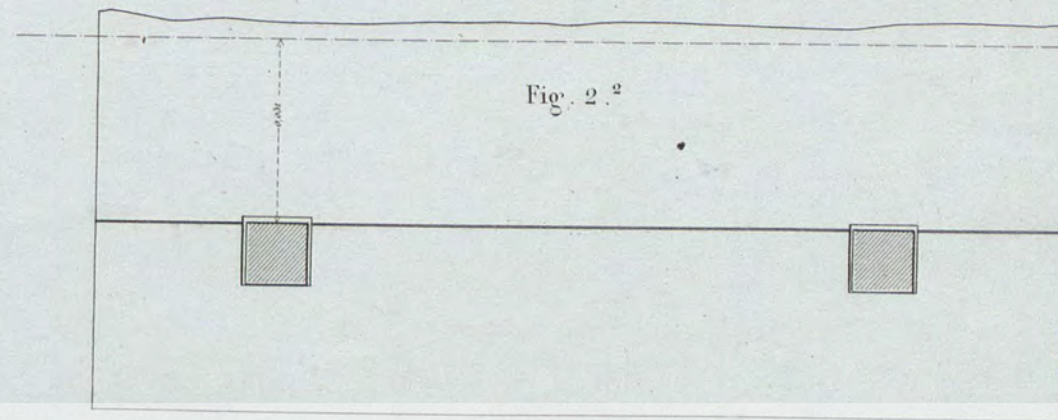
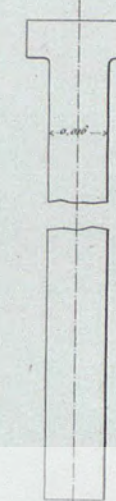

Fig. 2.<sup>4</sup>



Echelle de 0.50 pour 1 Mètre

A. Jacquin. dir.



Système Barberot

Fig. 1.

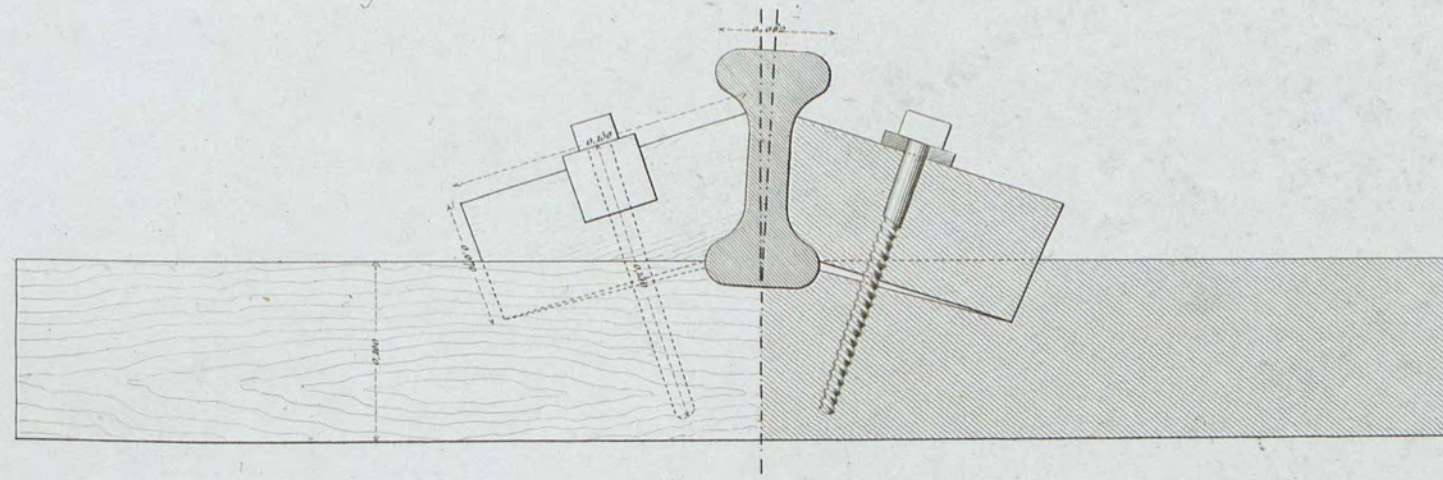

Fig. 1.<sup>1</sup>

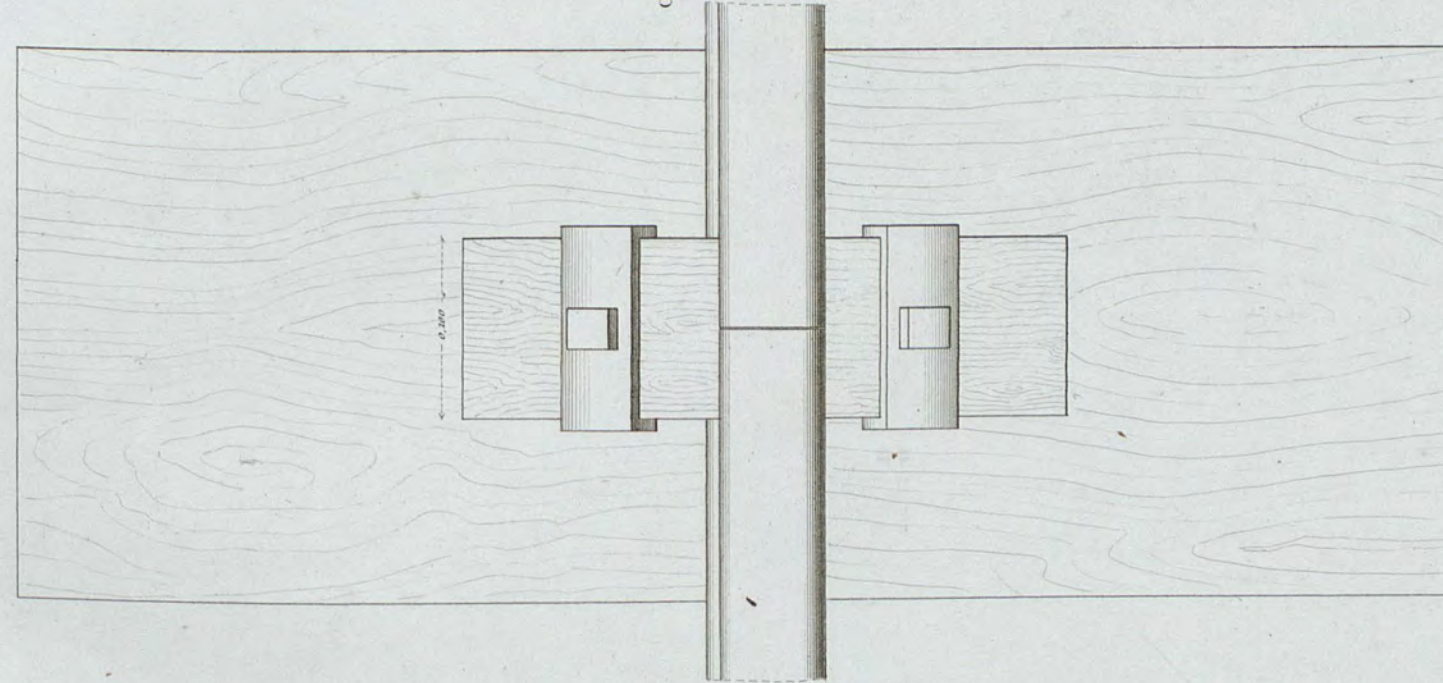
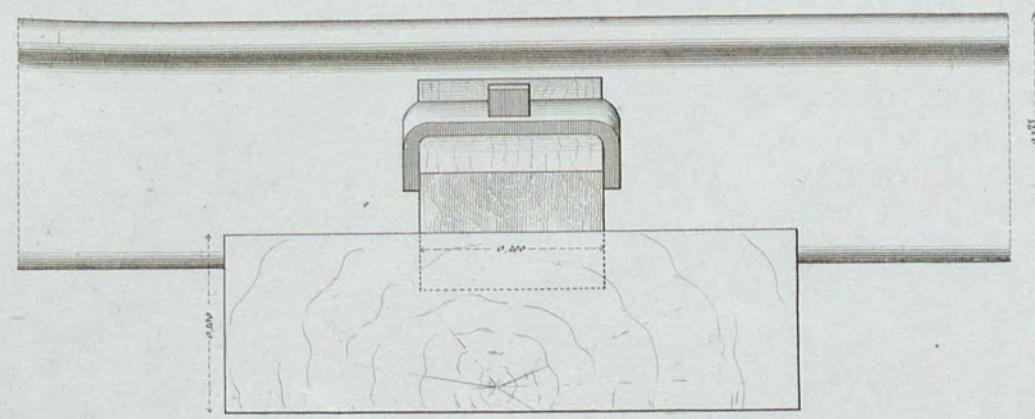

Fig. 1.<sup>2</sup>



Echelle de 0.25 pour 1 Met

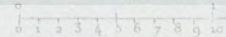

Fig. 2.

Système Pouillet

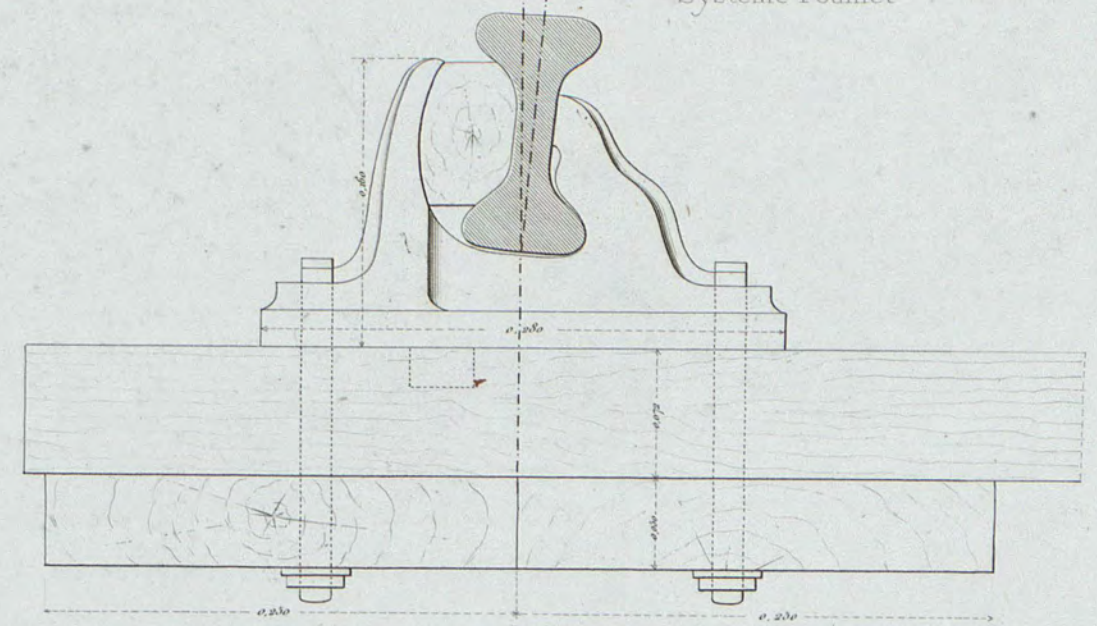
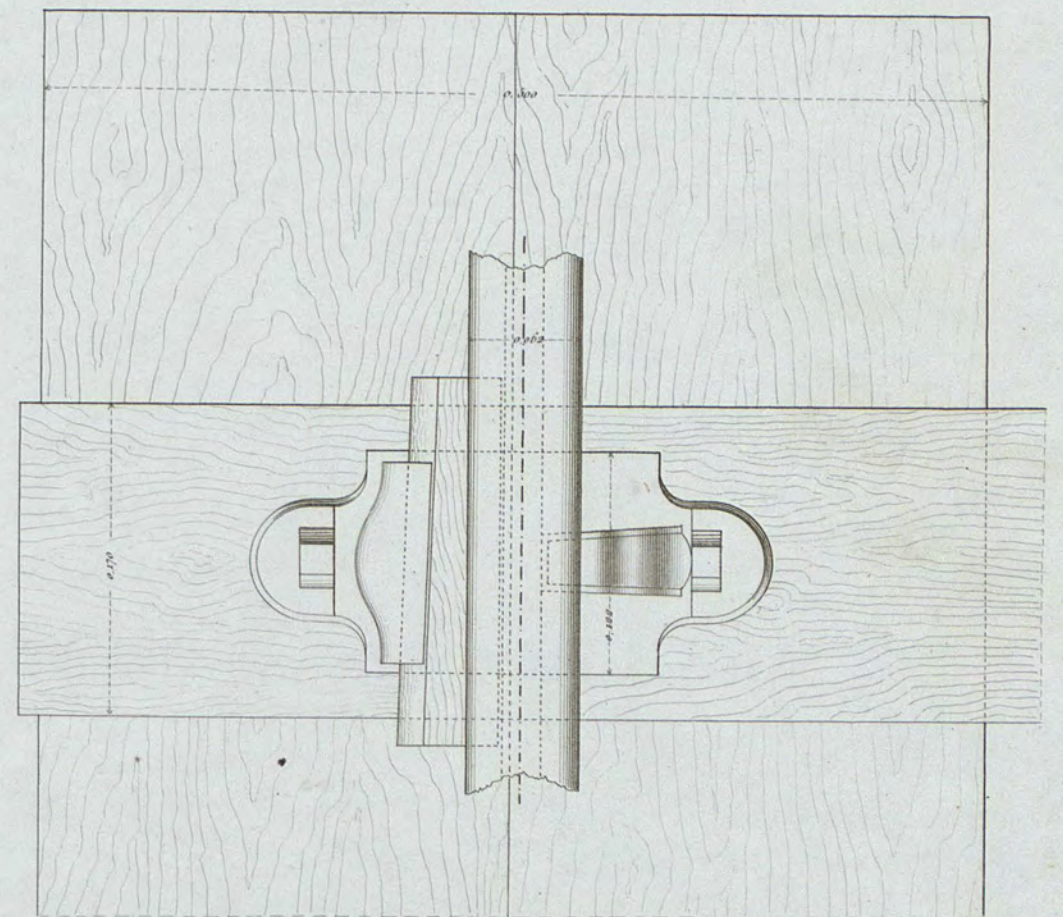
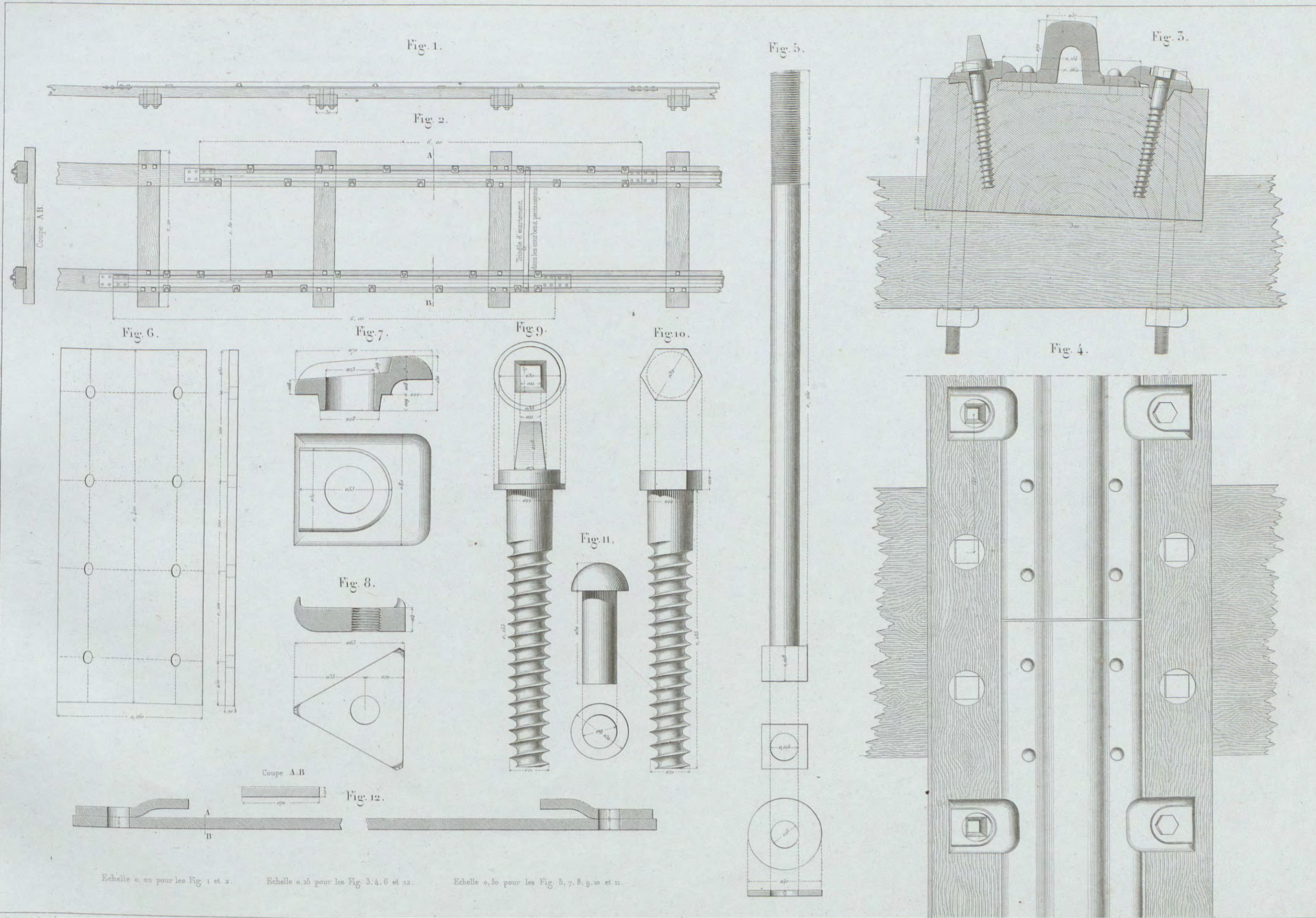

Fig. 2.<sup>1</sup>





Echelle 0,02 pour les Fig. 1 et 2.

Echelle 0,25 pour les Fig. 3, 4, 6 et 12.

Echelle 0,50 pour les Fig. 5, 7, 8, 9, 10 et 11.

A. Jacquin dess.

Exp. F. Chardon aux. de l'Etat, Paris.

L. Guignot del. et sc.



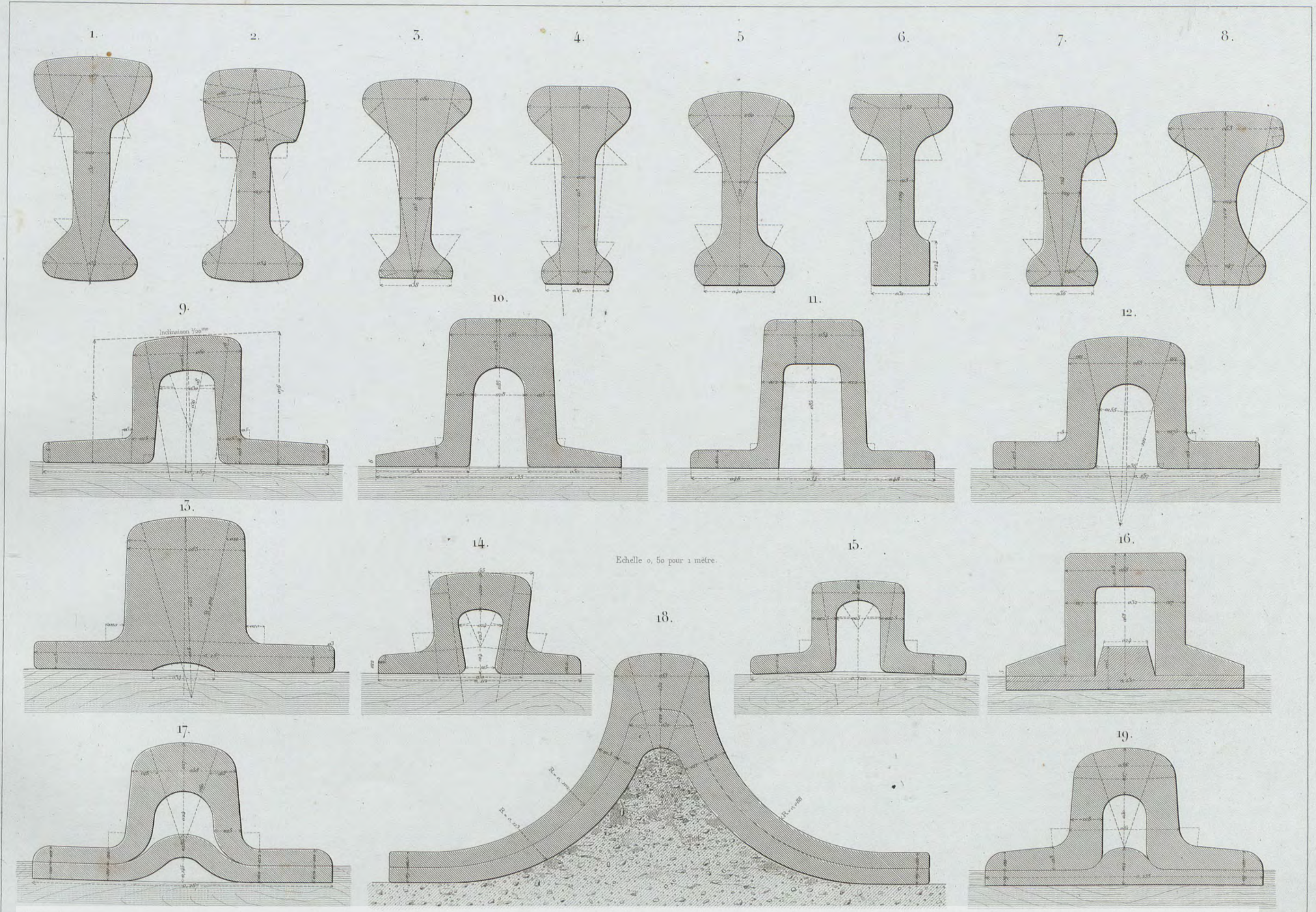

A. Jarczyk dir.

Dep. F. Chabot, inv. No. 1. Représent. Divers.

L. Guignot del. et sc.





Fig. 1.

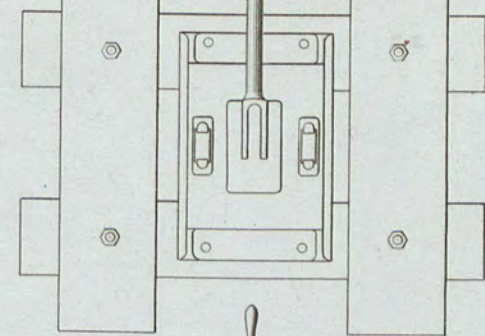
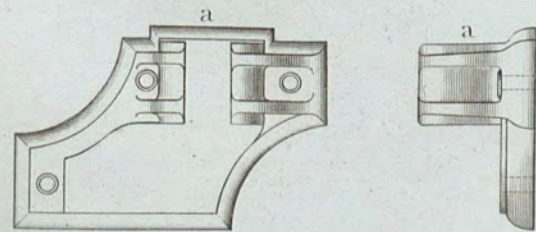
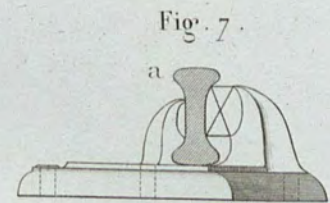
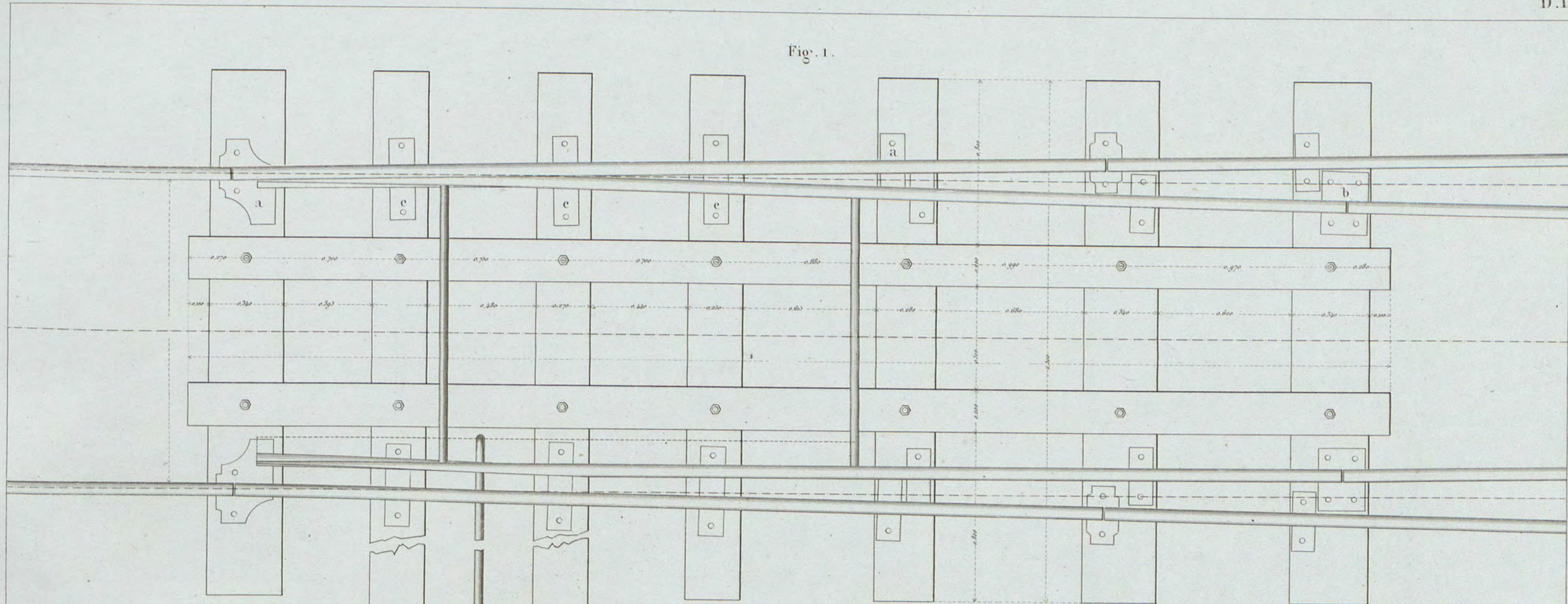

Fig. 3.

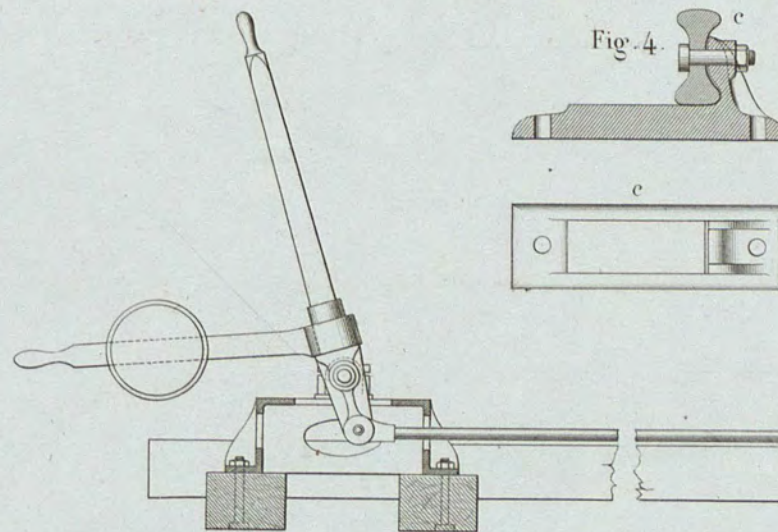

Fig. 4.

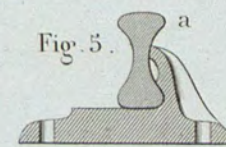

Fig. 5.

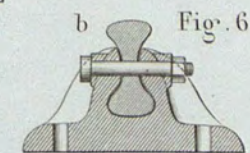
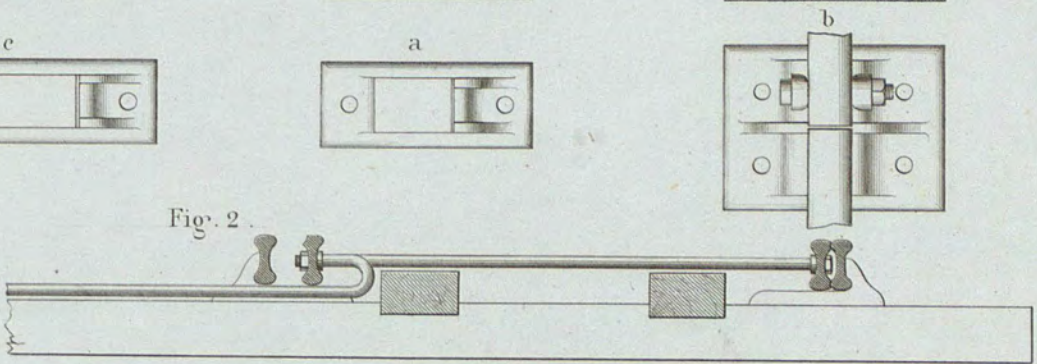

Fig. 6.

Fig. 2.



Echelle de 0.05 pour 1 Metre pour les Fig. 1, 2 et 3.

Echelle de 0.10 pour 1 Metre pour les Fig. 4, 5 et 6.

A. Jacquin dir.

L. Guignot del. et Sc.



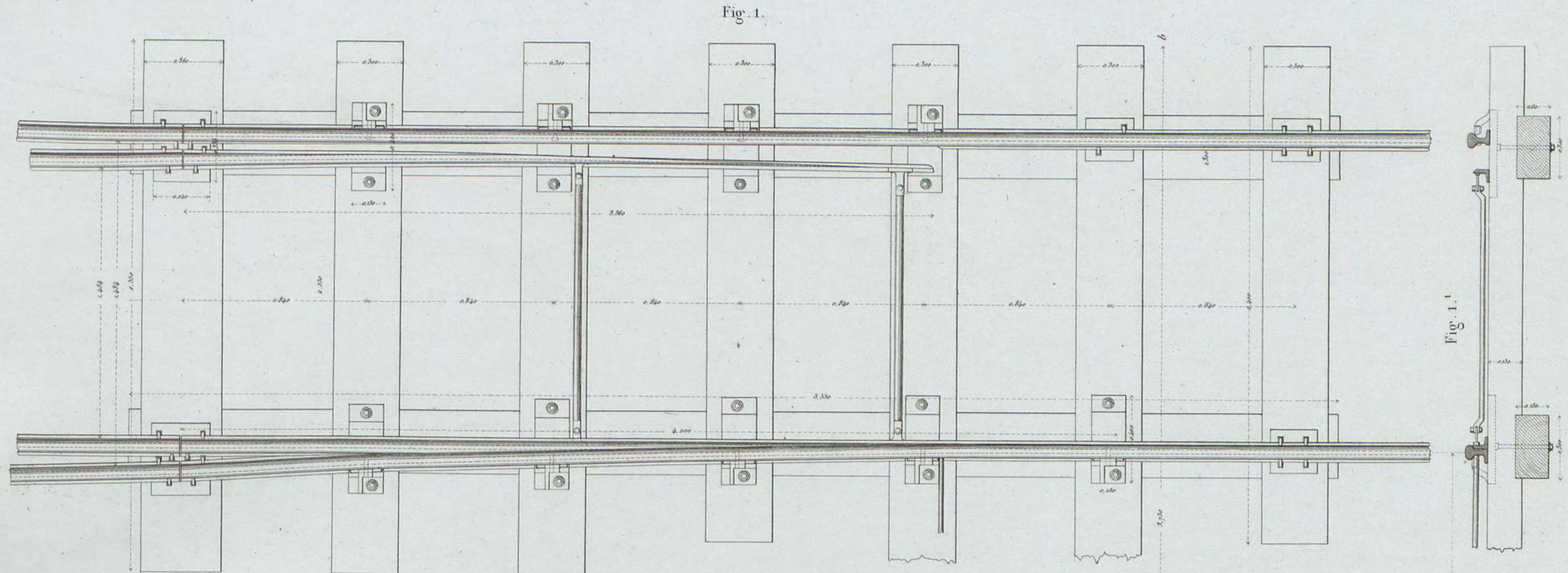

Fig. 1.

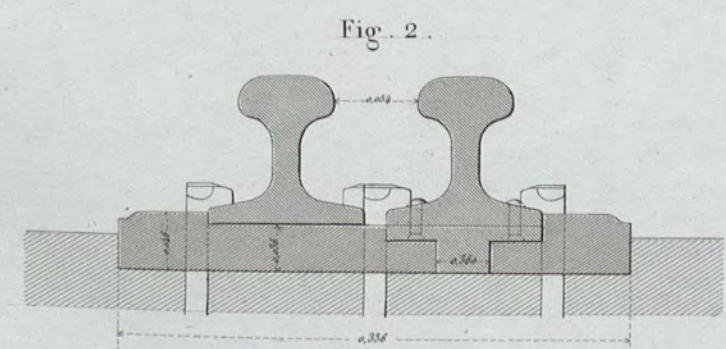
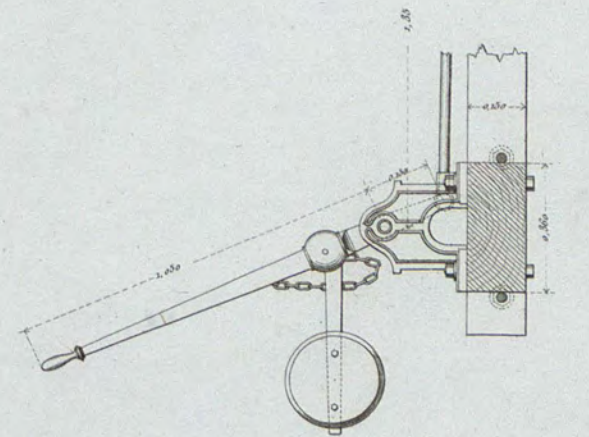
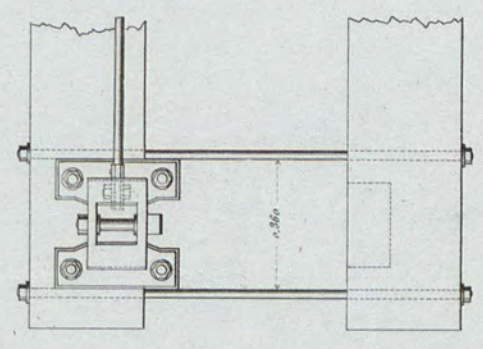
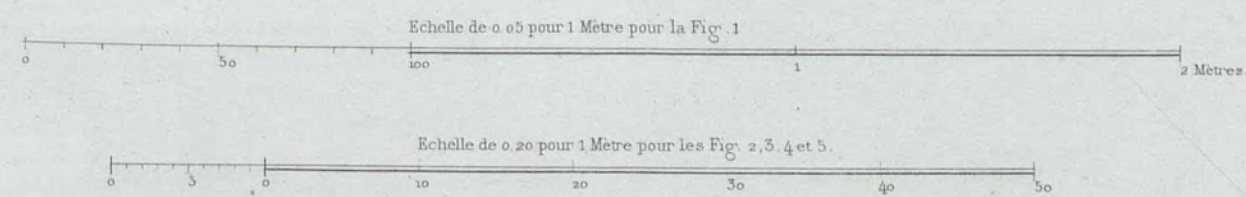

Fig. 2.

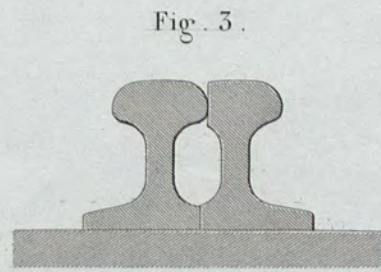

Fig. 3.

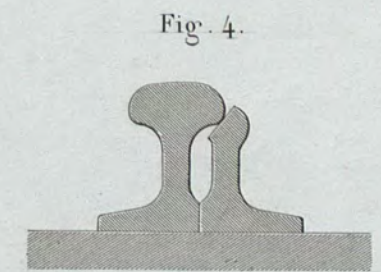

Fig. 4.

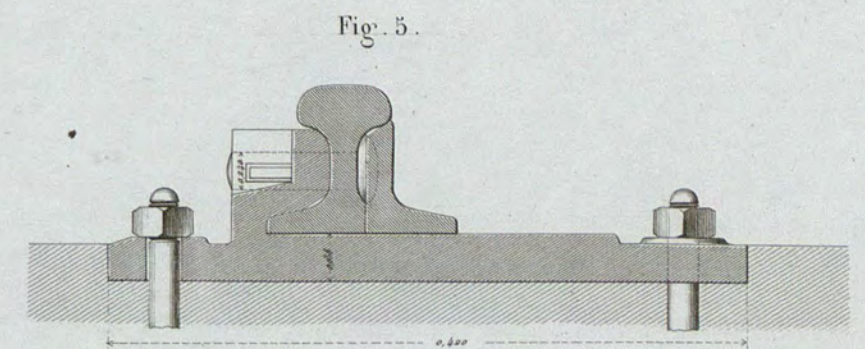

Fig. 5.

A. Jacquin, dir.

Imp. P. Bache et Co. r. Hauteville Paris

L. Guignot del. et Sc.



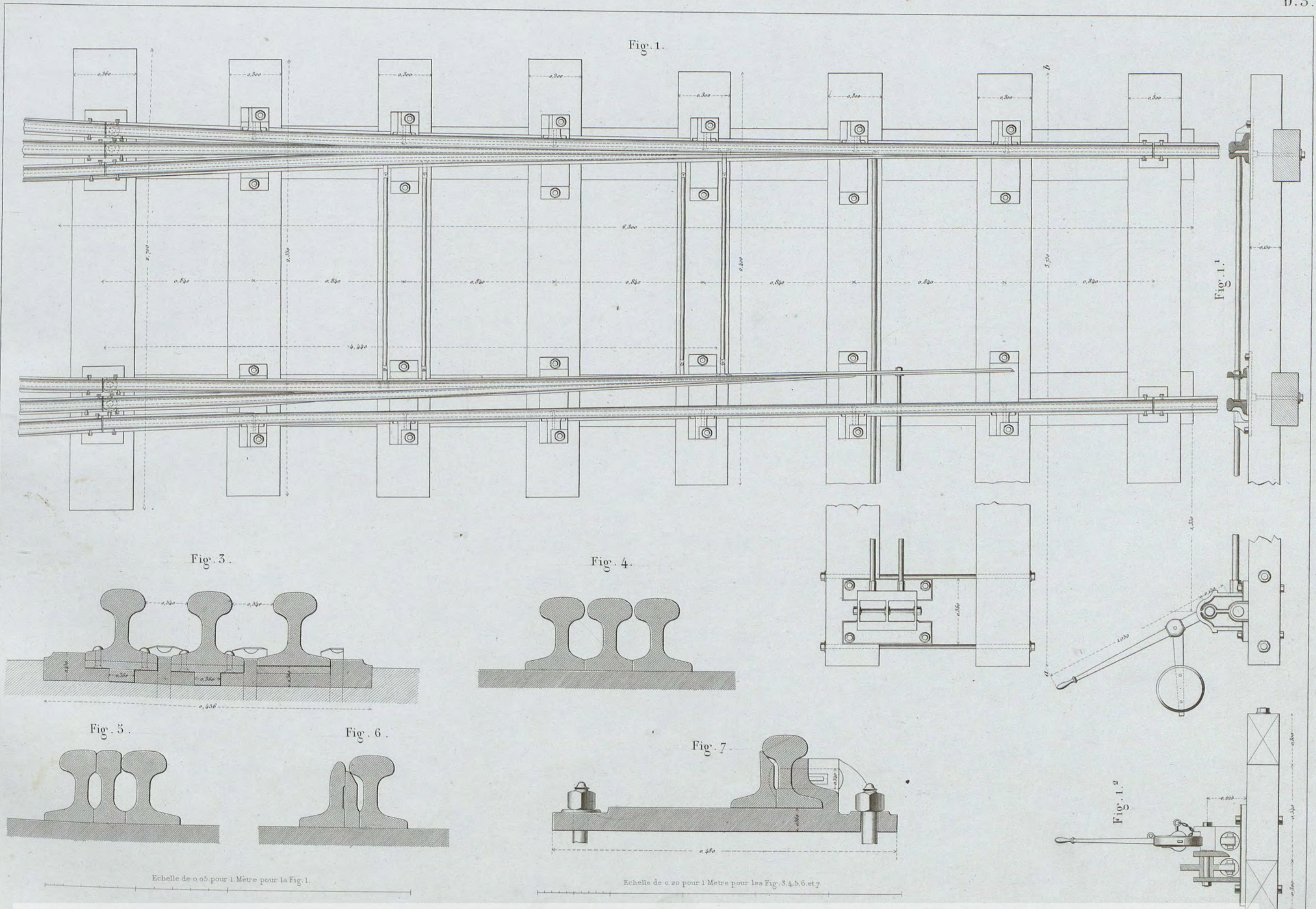

A. Jacquin dir.

Imp. F. Bardon aîné, 54, rue de Valenciennes, Paris

L. Guignet del et Sc.



Fig. 1.

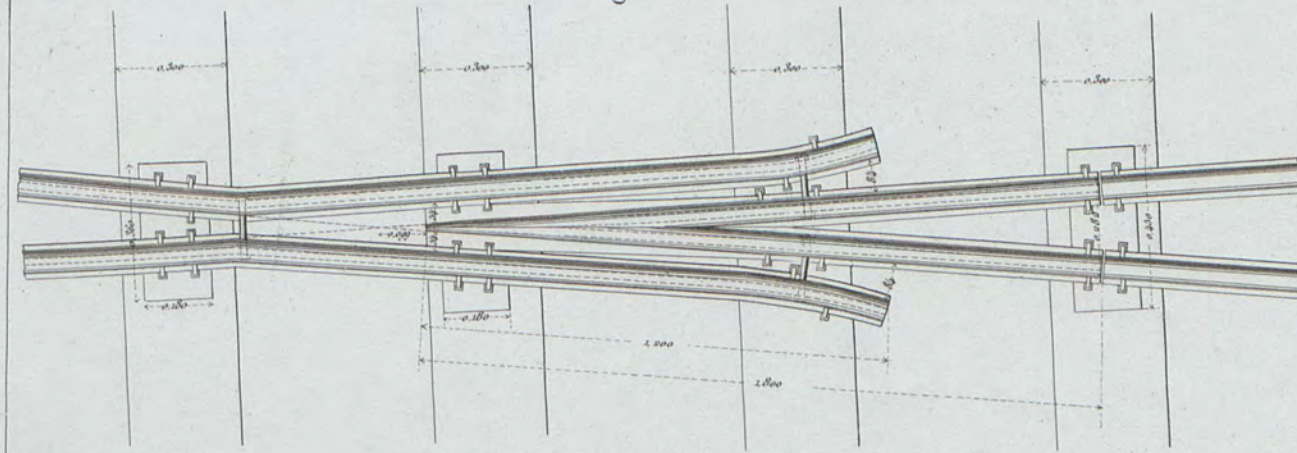

Fig. 2.

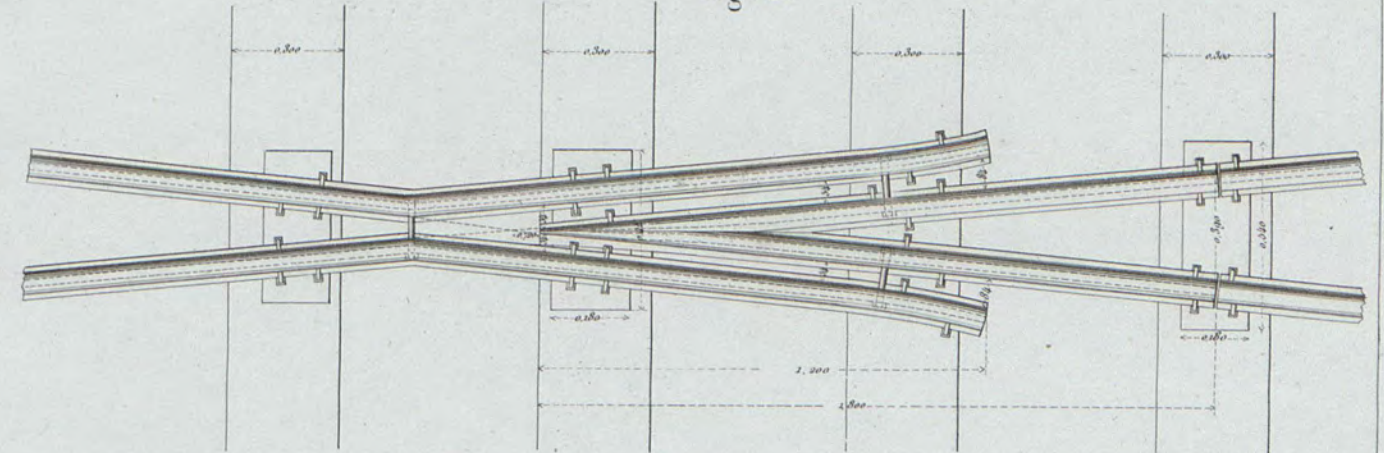

Fig. 3.

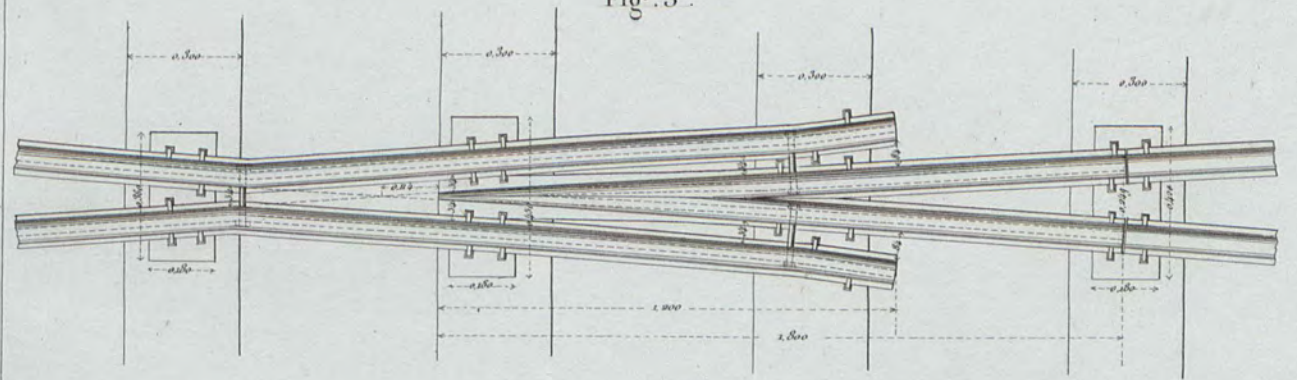

Fig. 4.

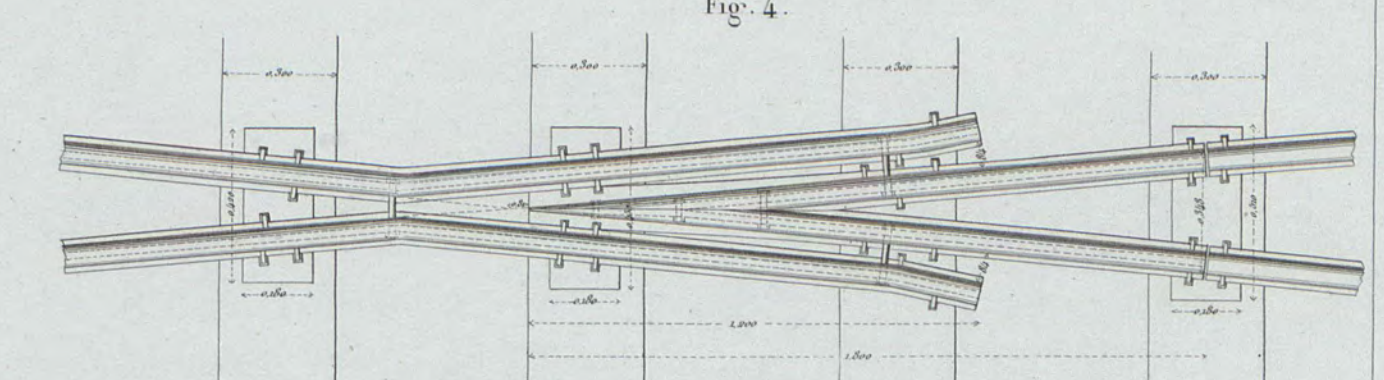

Fig. 5.

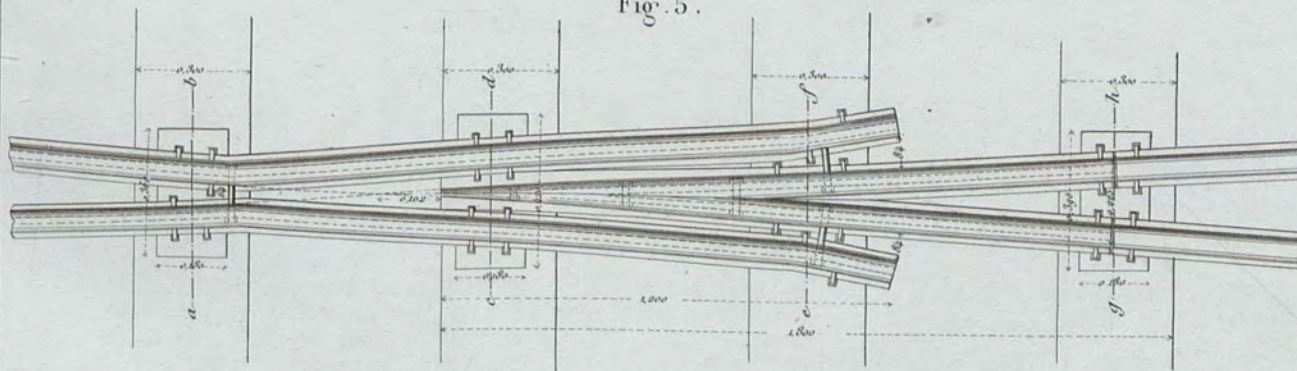

Fig. 6.

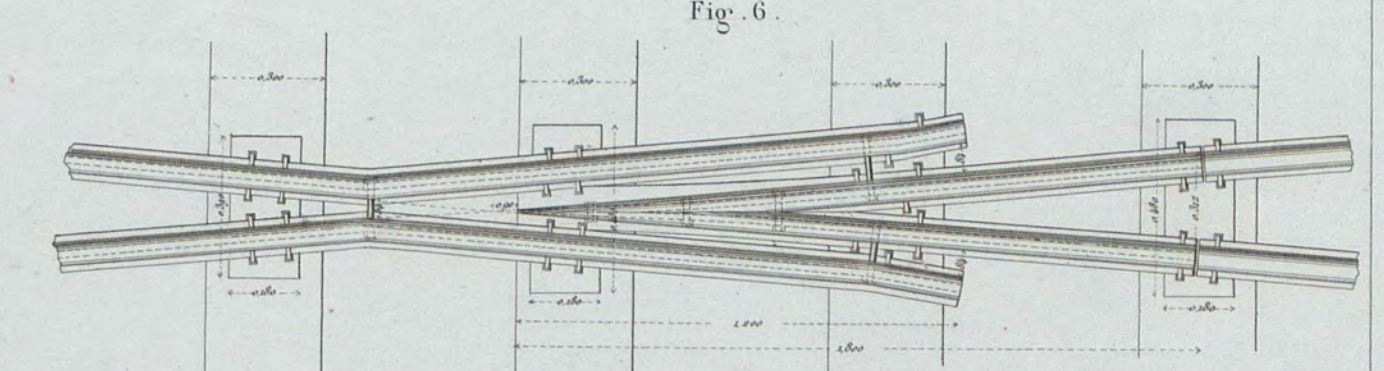

Fig. 7.

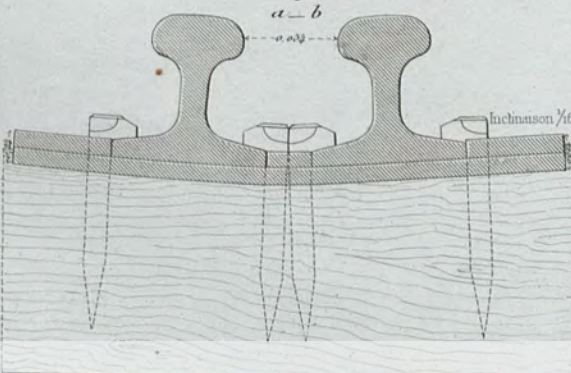

Fig. 8.

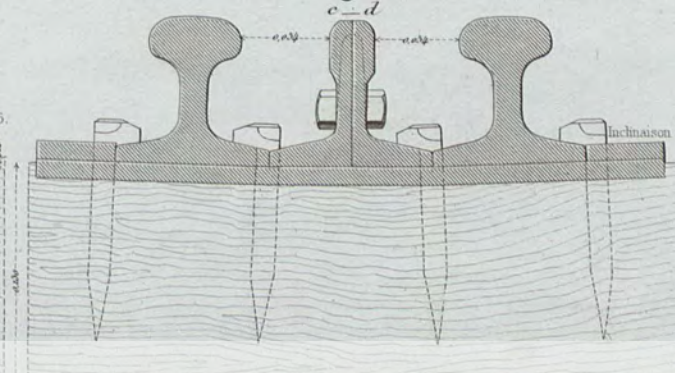

Fig. 9.

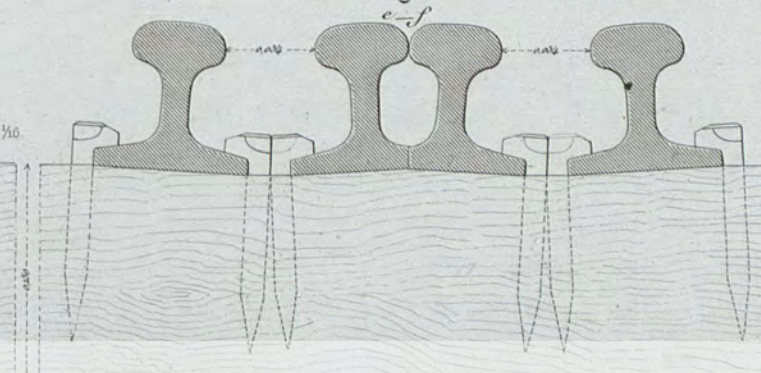
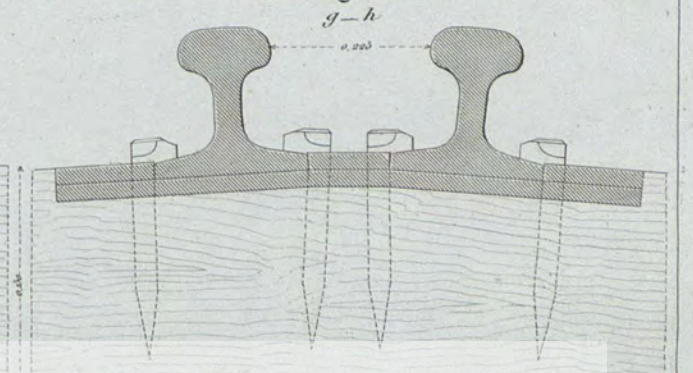

Fig. 10.



Echelle de 0.05 pour 1 Mètre pour les Fig. 1, 2, 3, 4, 5 et 6.

Echelle de 0.30 pour 1 Mètre pour les Fig. 7, 8, 9 et 10.

A. Jacquin, dir.



L. Guignet, del. et Sc.

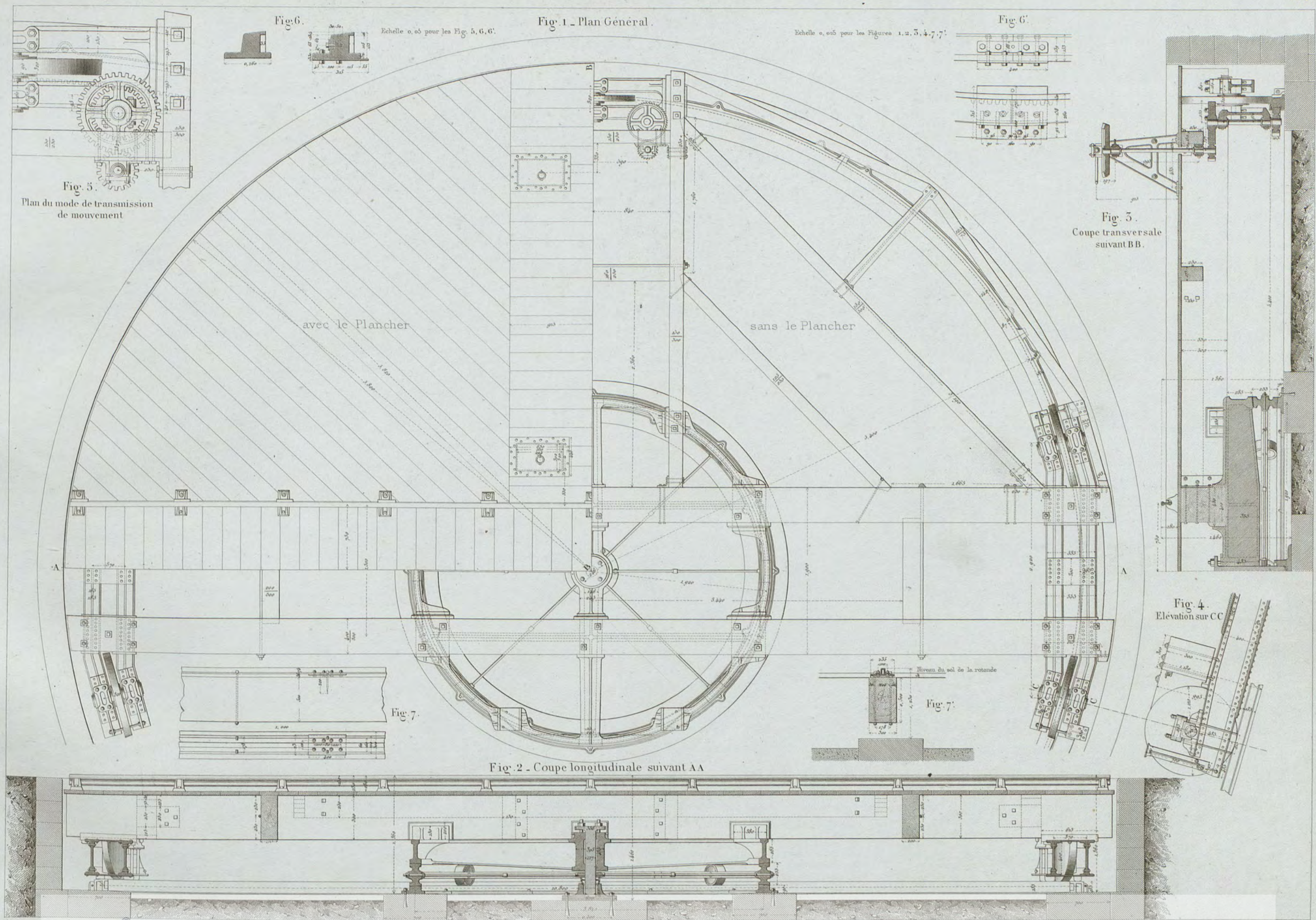

A. Jacquin, direct.

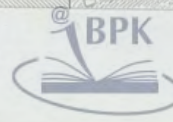

BIBLIOTEKA CYFROWA POLITECHNIKI KRAKOWSKIEJ

L. Guignot del. et Sc.

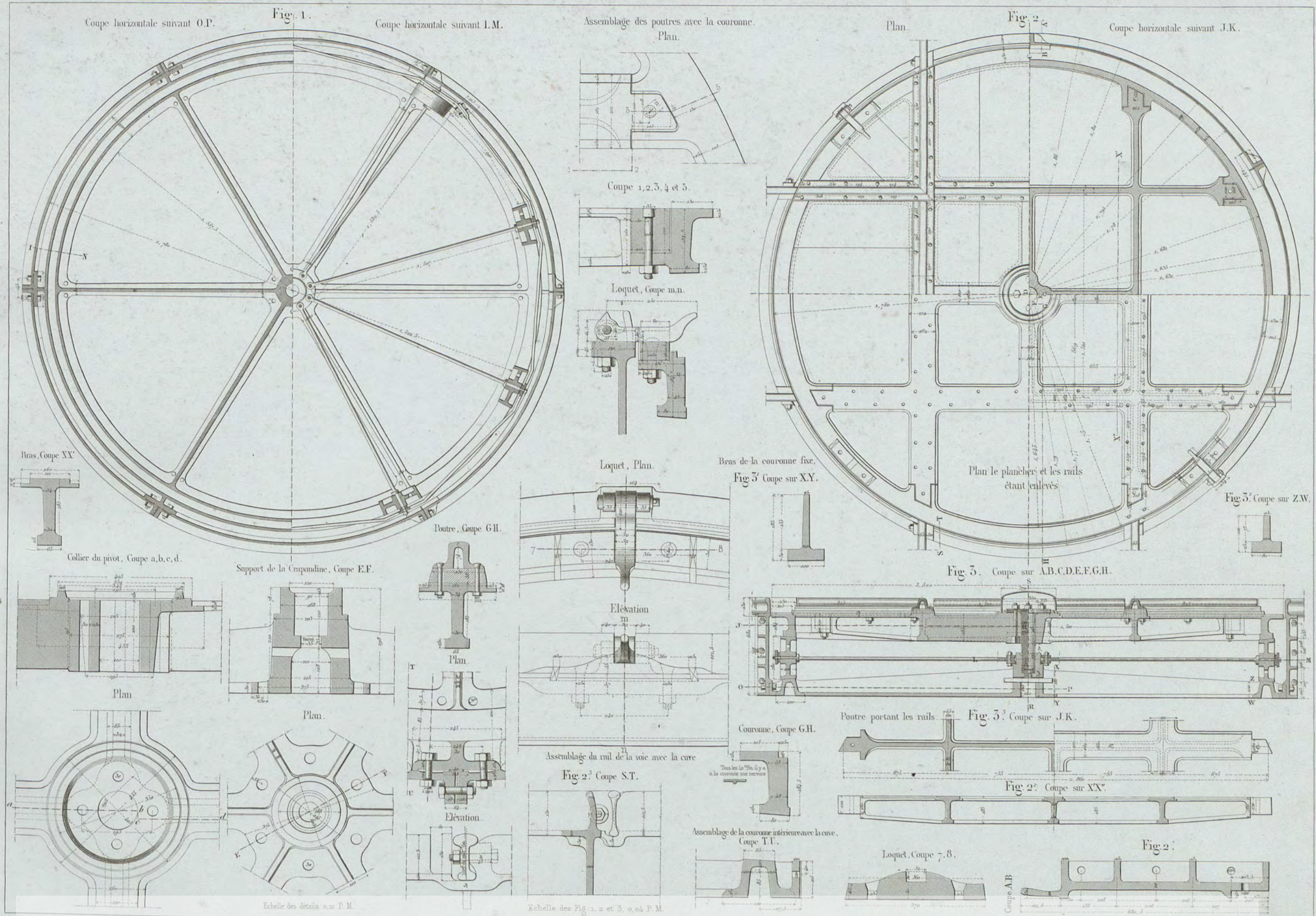

A. Jacquin direct.

Imp. P. Chardon aîné, 36, r. Montmartre, Paris.

L. Guignot del et sc.

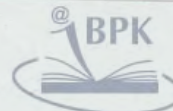
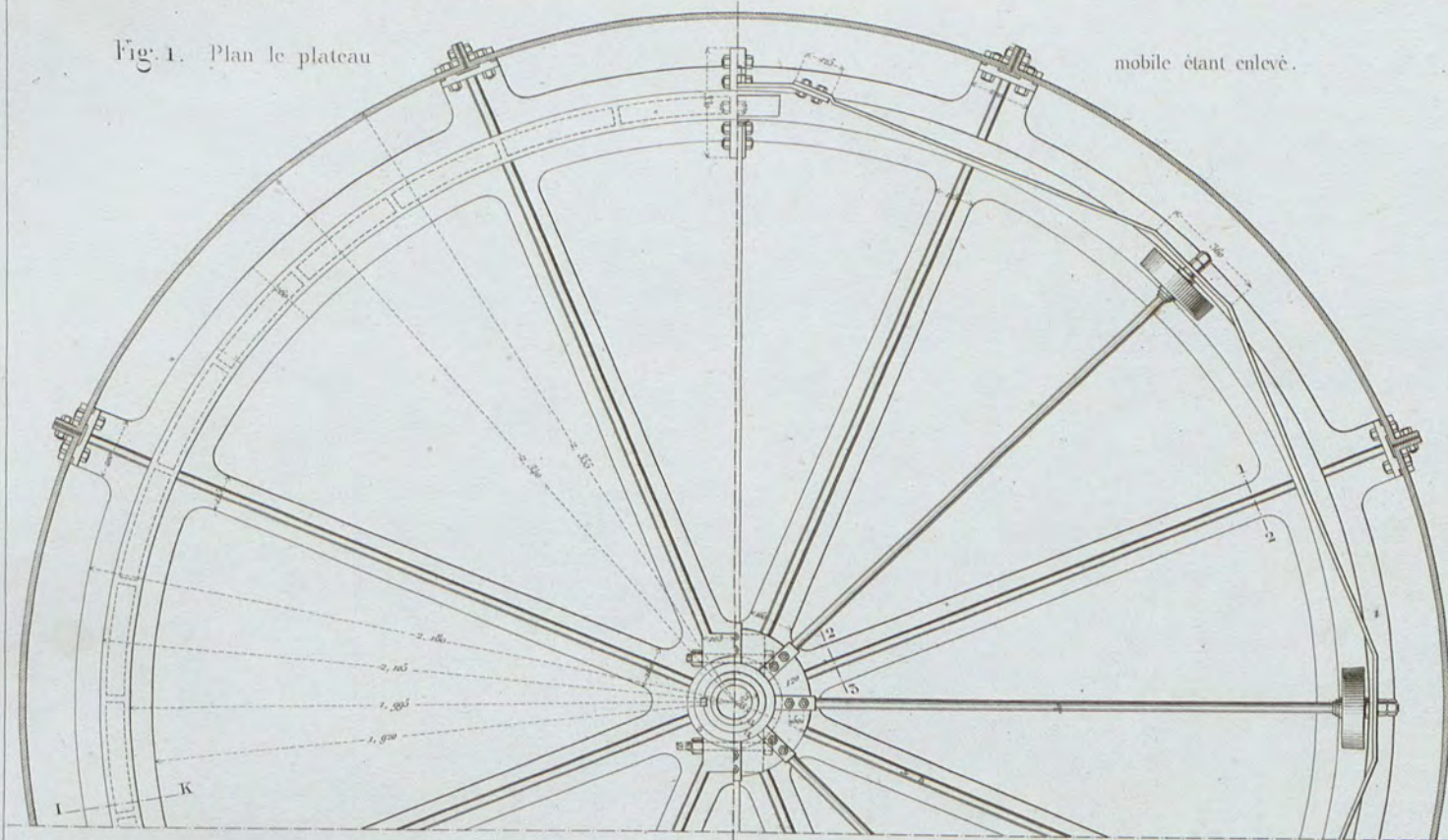

Fig. 1. Plan le plateau



Plan, la plaque étant au complet.

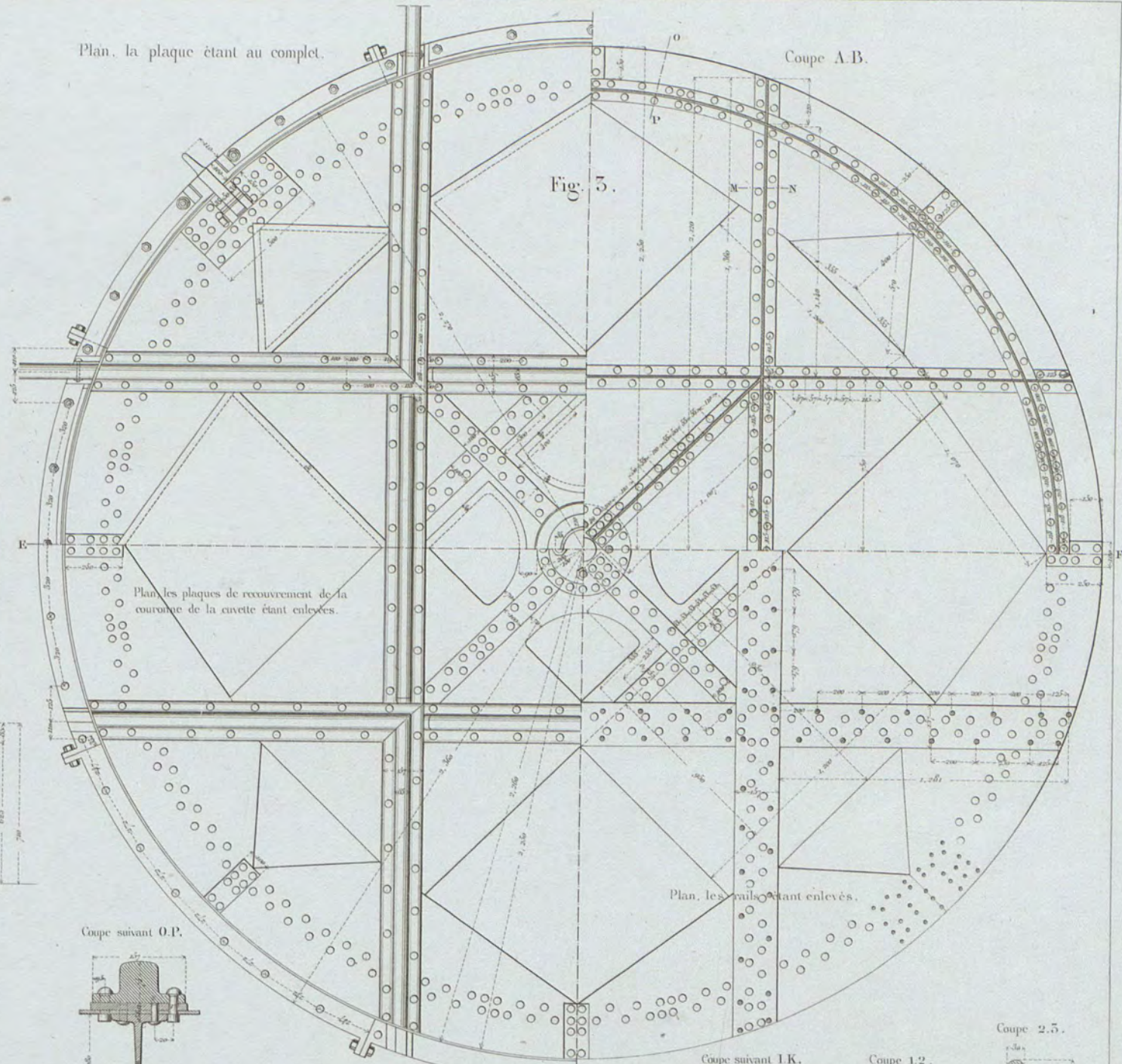
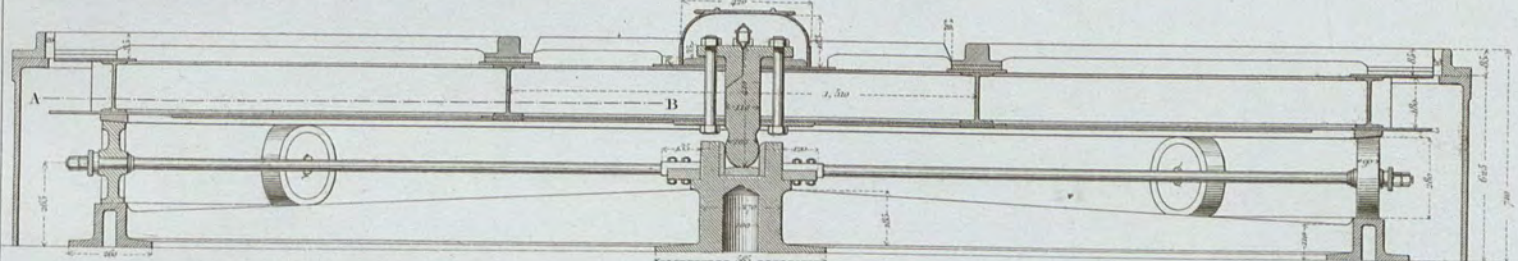

Fig. 2. Coupe verticale suivant E.F.



Coupe suivant S.T.

Elevation.

Coupe suivant M.N.

Coupe suivant O.P.

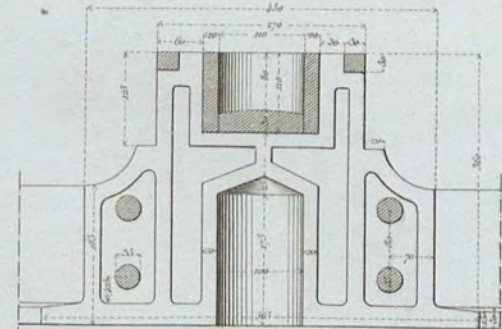

Assemblage de la cavette avec la couronne de roulement.

Coupe suivant X.Y.

X Vue de face.

Détail de l'assemblage de la couronne de roulement.

Coupe suivant I.K.

Coupe 1.2.

Coupe 2.5.

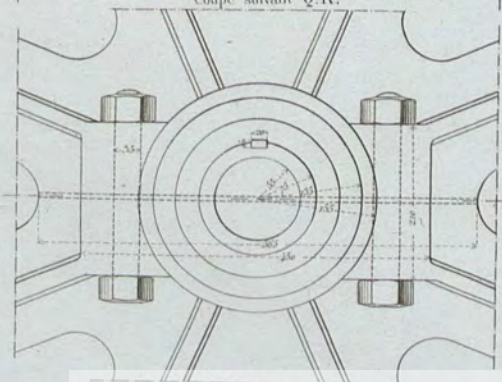

Plan.

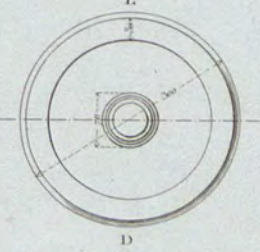
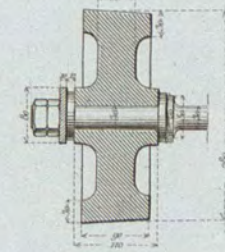
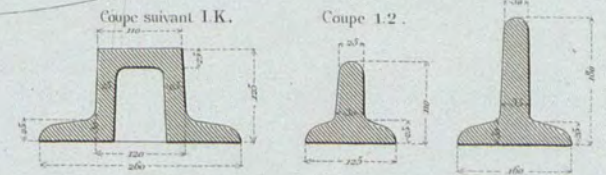
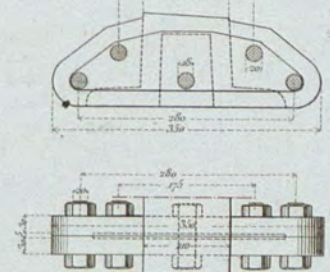
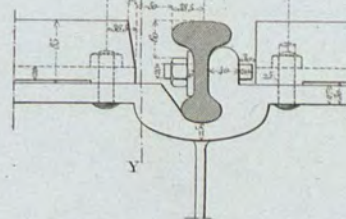

Echelle des fig. 1, 2, 3, 0,04 pour mètr.

Echelle des détails 0,10 p. m.

A. Jacquin direx.

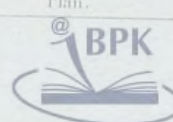

L. Guignot del. et sc.

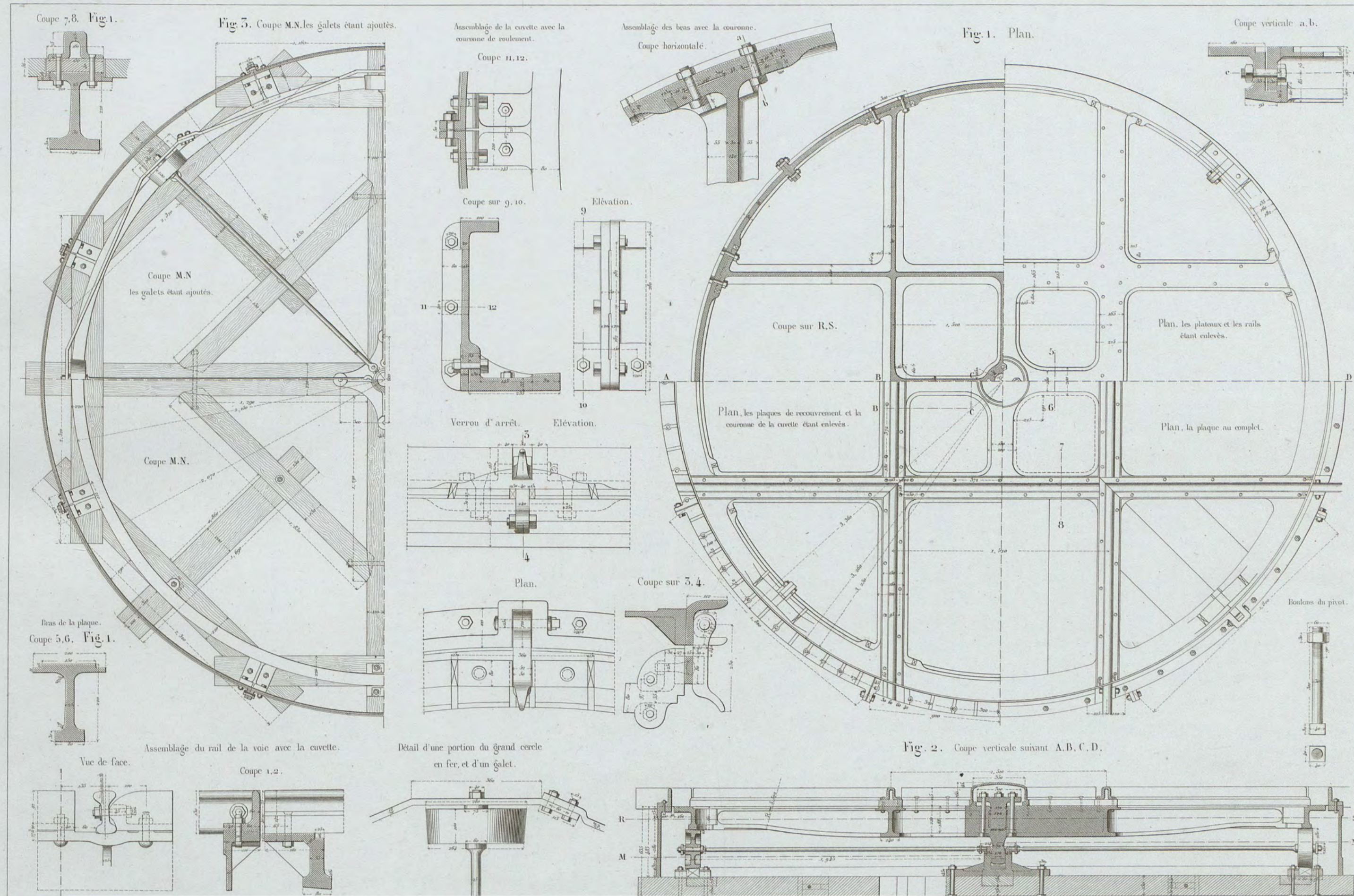

Echelle des Fig 1, 2, 3, 0, 04 pour mètr.

Echelle des détails 0,10 pour mètr.

A. Jacquin direx

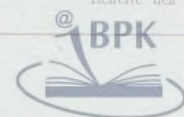

L. Cugnet del. et sc.



Fig. 6. Détail du pivot.

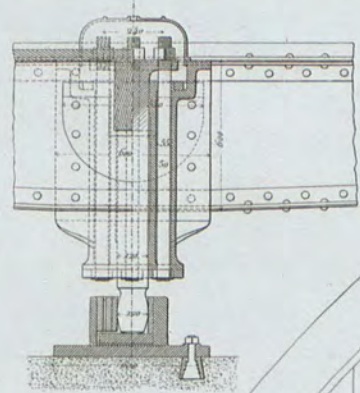

Fig. 7. Plan de la Grapaudine

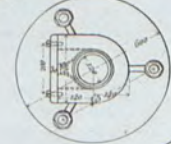

Fig. 1.

Plan.

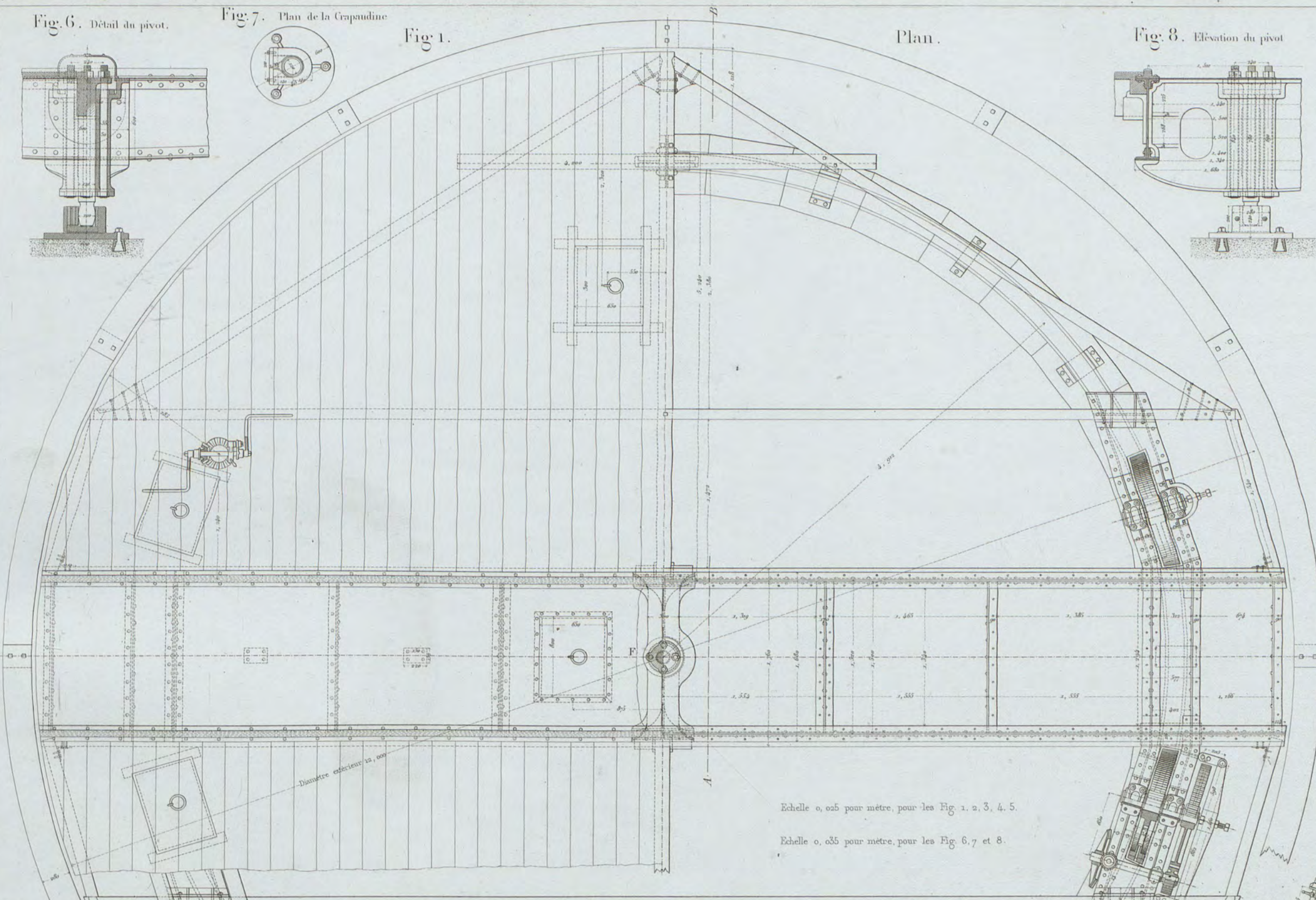

Fig. 8. Elevation du pivot

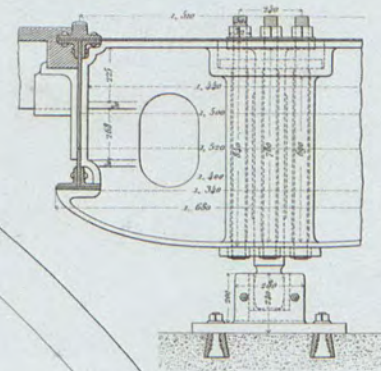
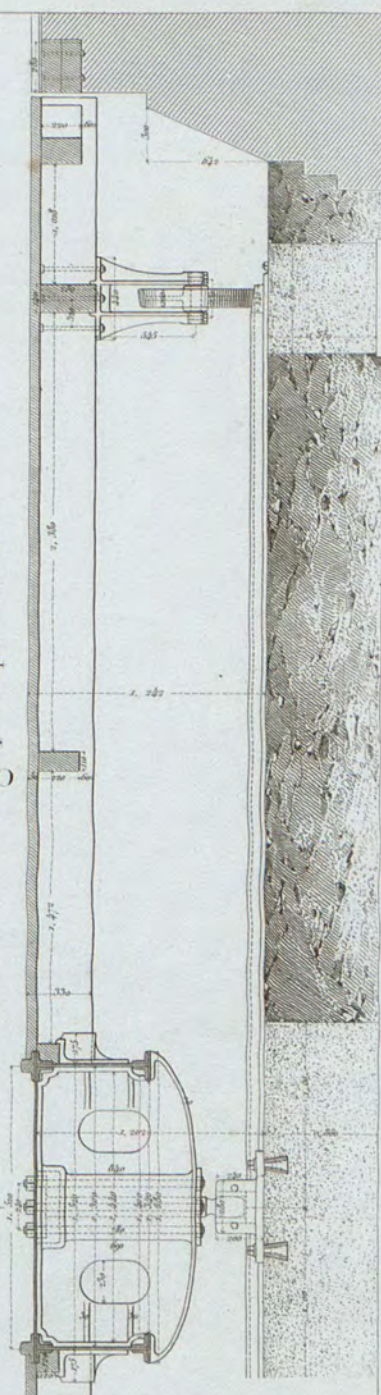

Fig. 4. Coupe suivant A.B.



Echelle 0,025 pour metre, pour les Fig. 1, 2, 3, 4, 5.

Echelle 0,035 pour metre, pour les Fig. 6, 7 et 8.

Fig. 2. Elevation.

Fig. 3. Coupe suivant E.G

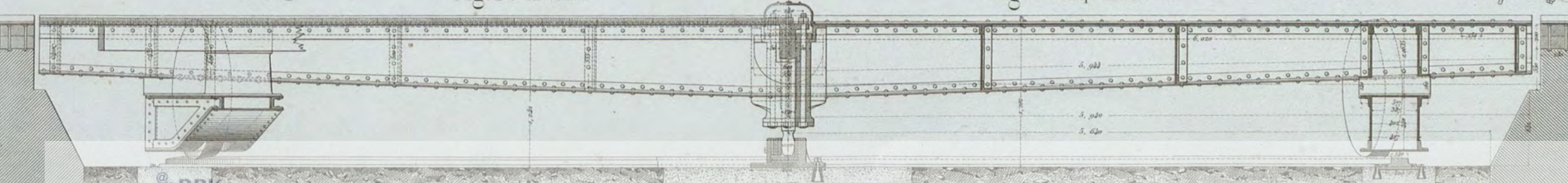
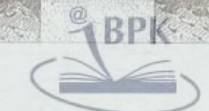
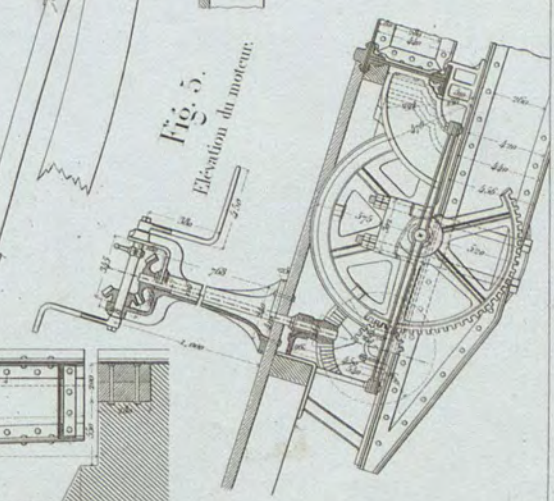
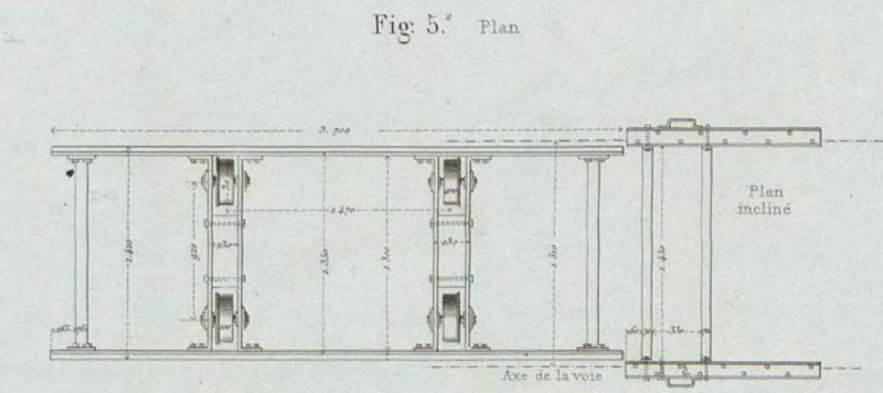
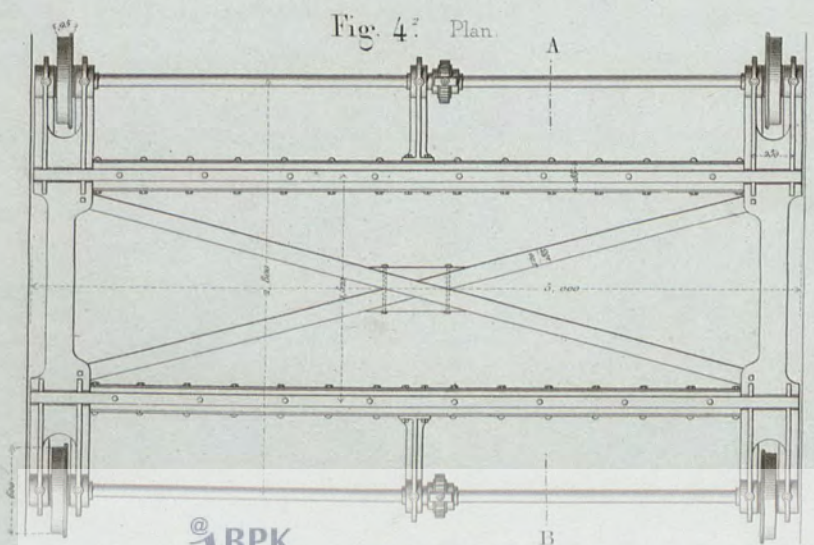
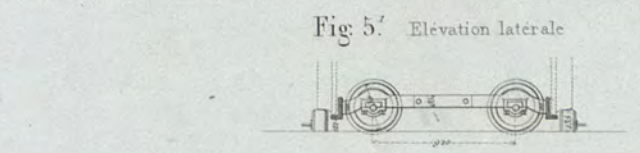
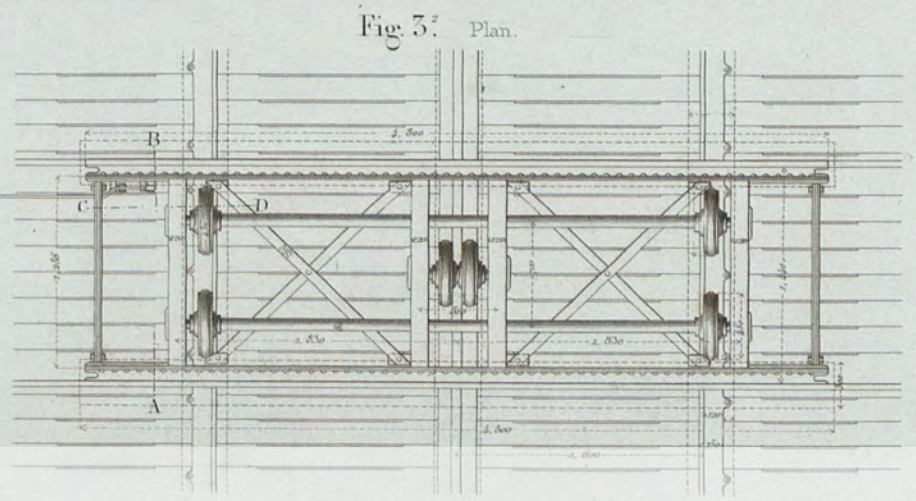
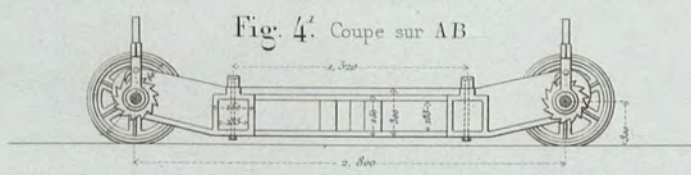
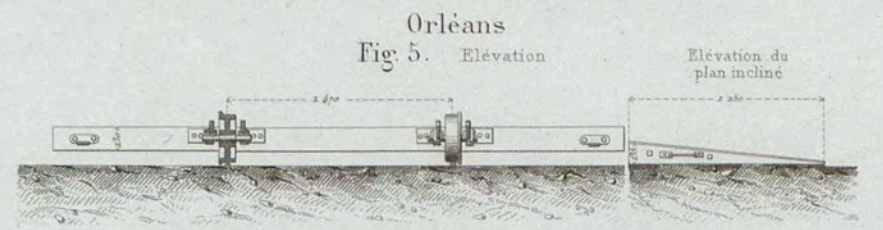
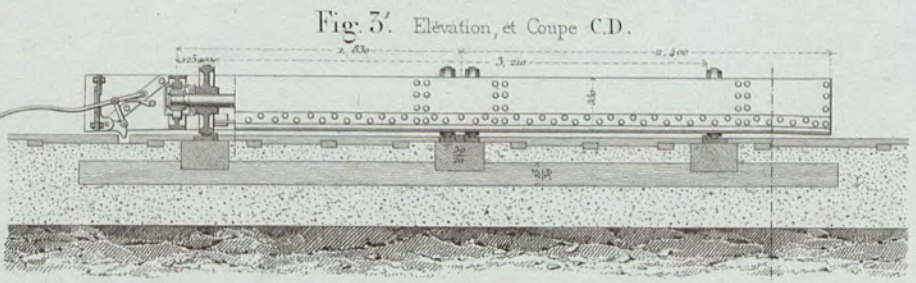
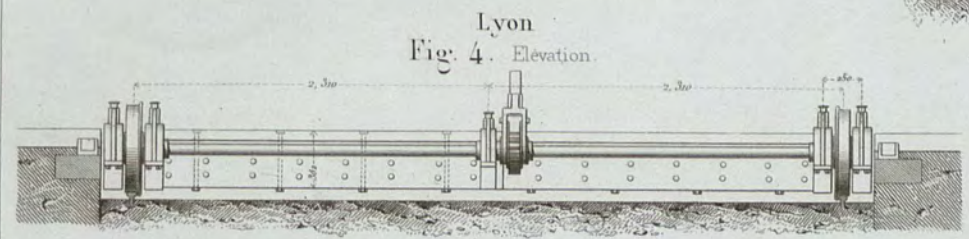
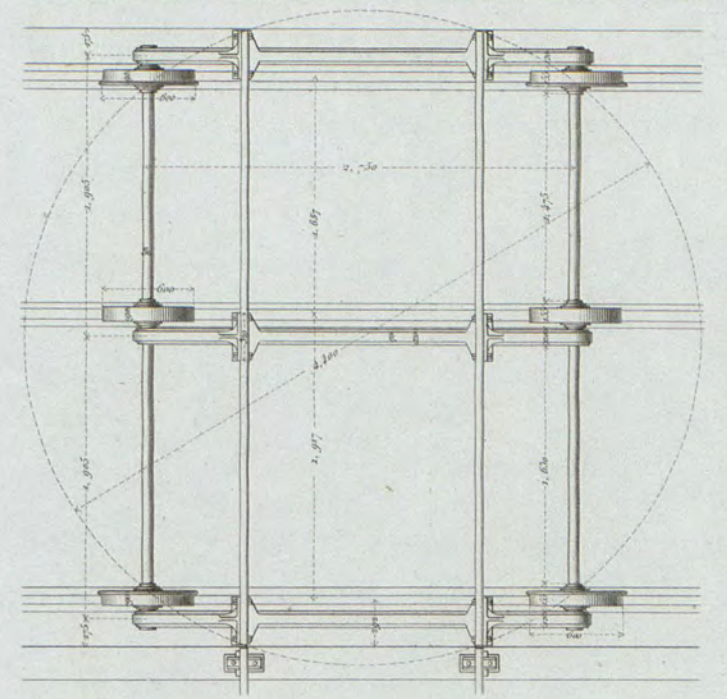
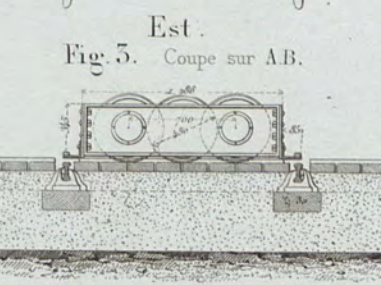
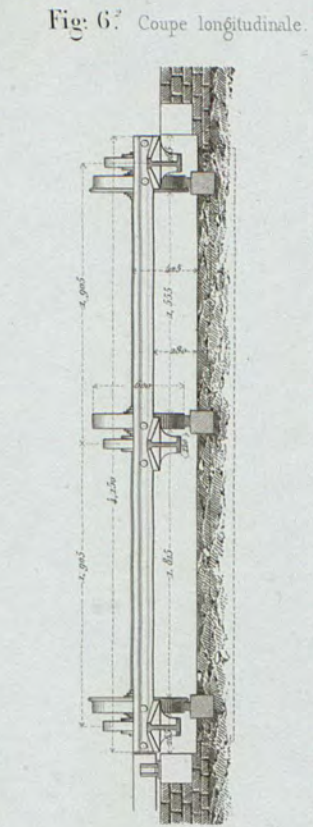
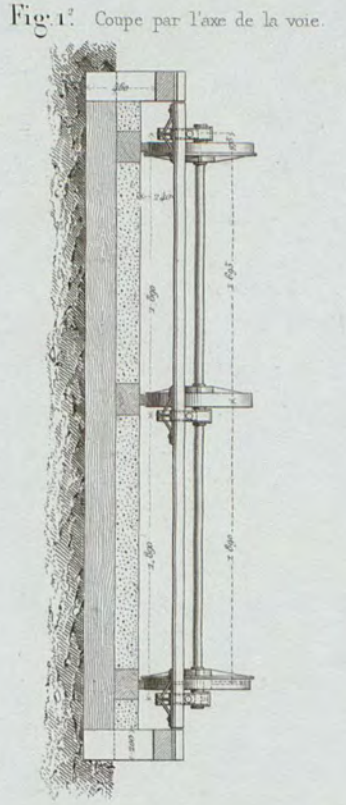
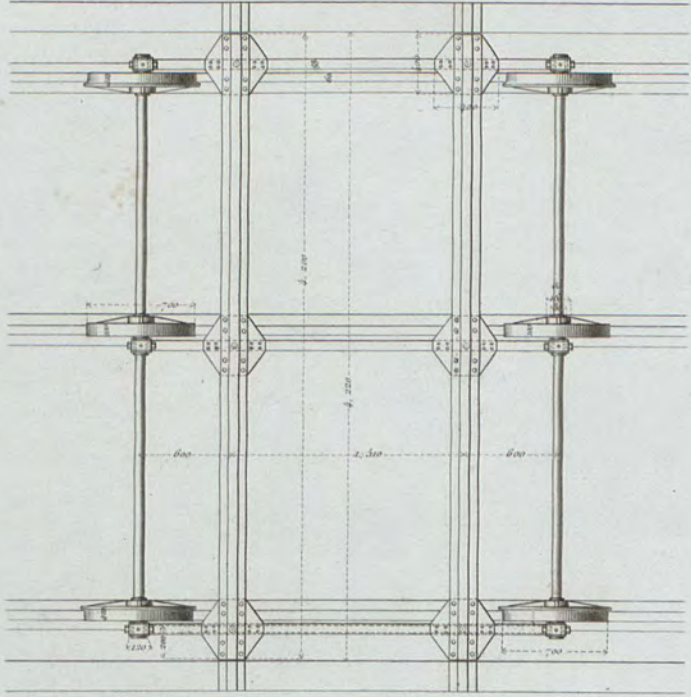
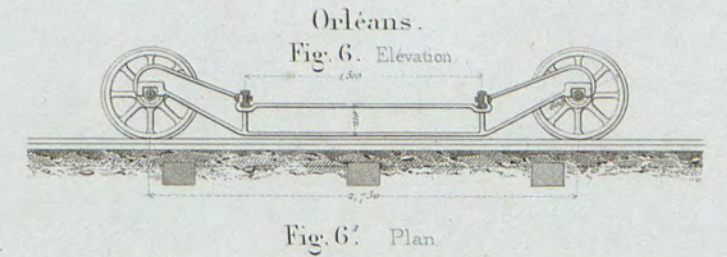
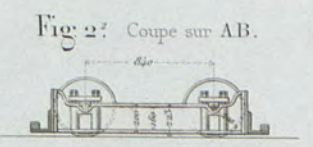
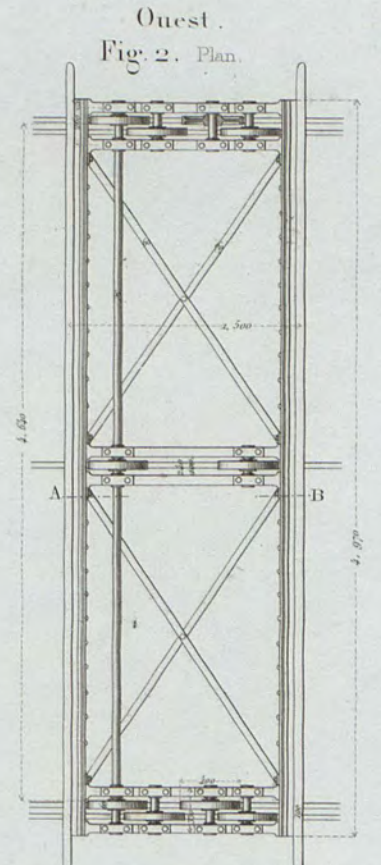
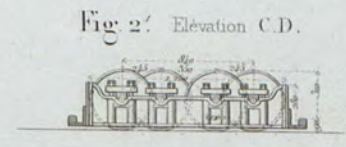
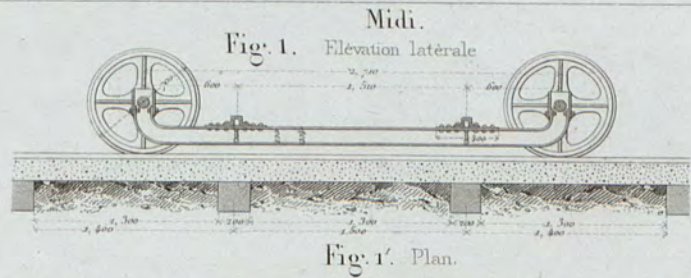

Fig. 5. Elevation du moteur.





Echelle 0,02 pour metre.



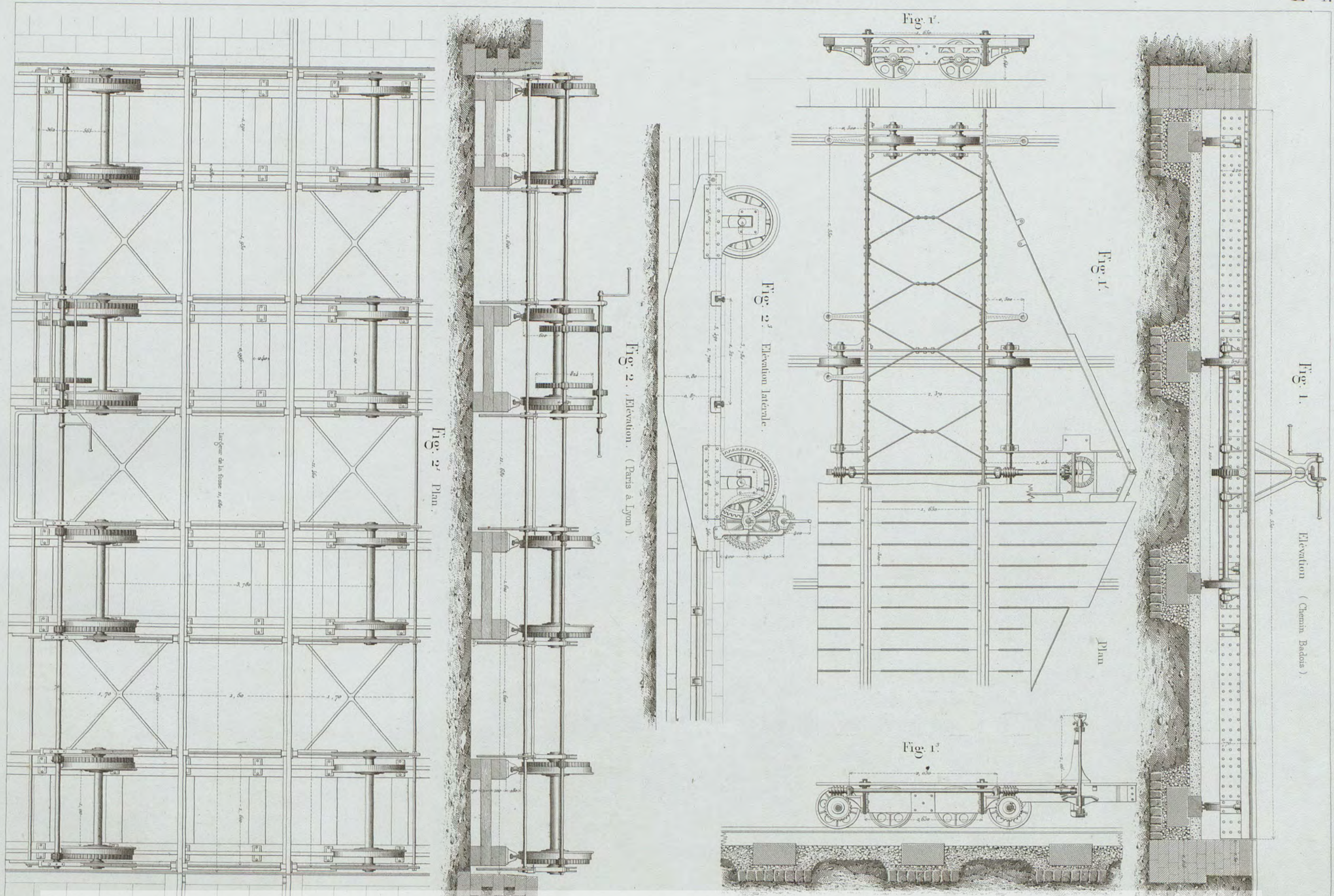

Fig. 1. Élévation. Voiture de 1<sup>re</sup> classe.

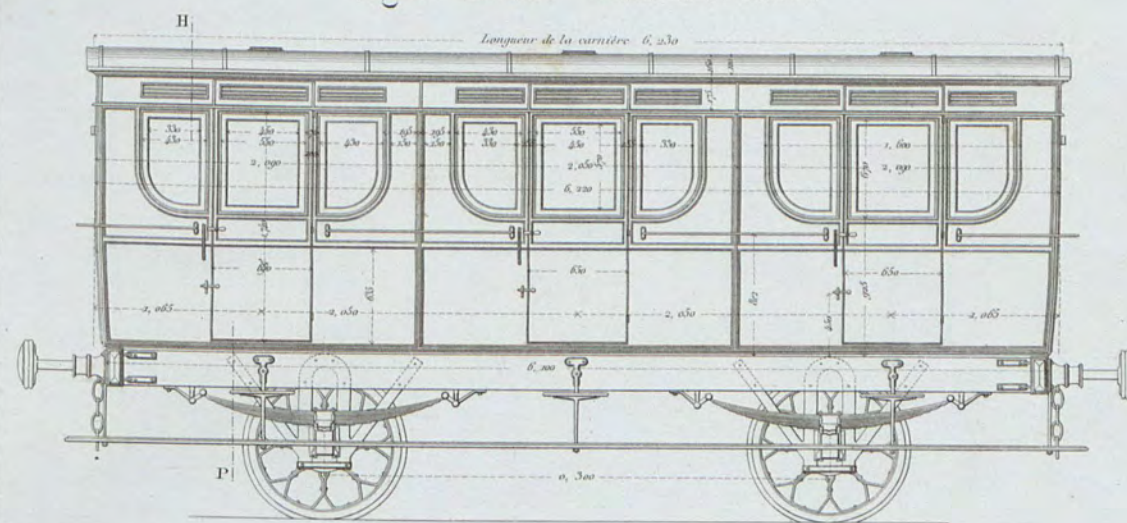

Fig. 1<sup>re</sup>. Coupe transversale.

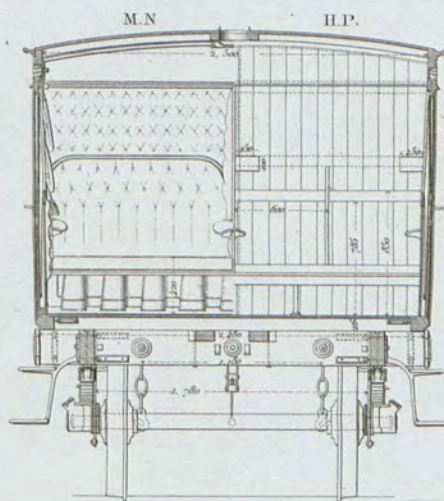

Fig. 2. Élévation. Voiture de 2<sup>me</sup> classe.

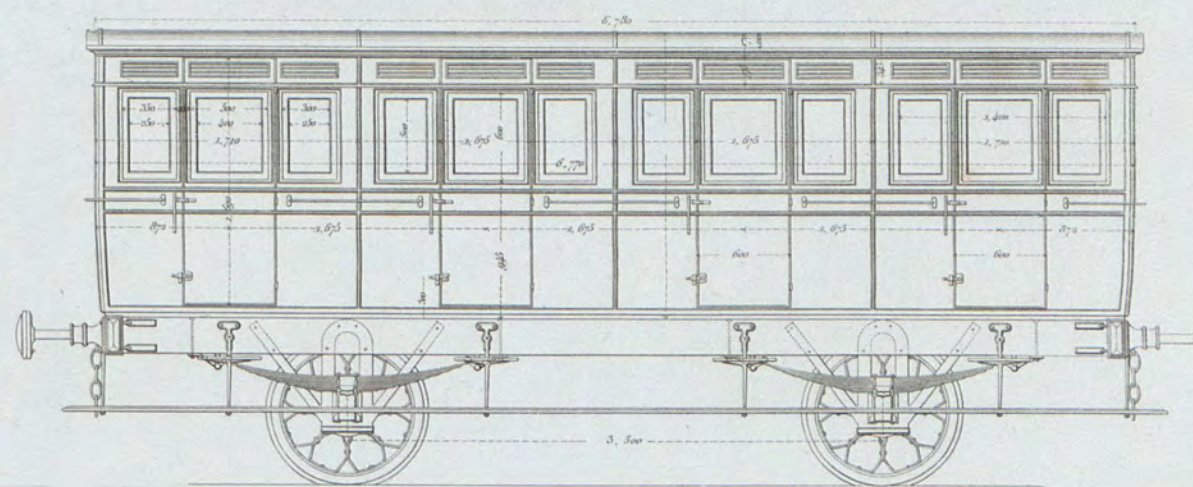

Fig. 1<sup>re</sup>. Coupe longitudinale. A.L.

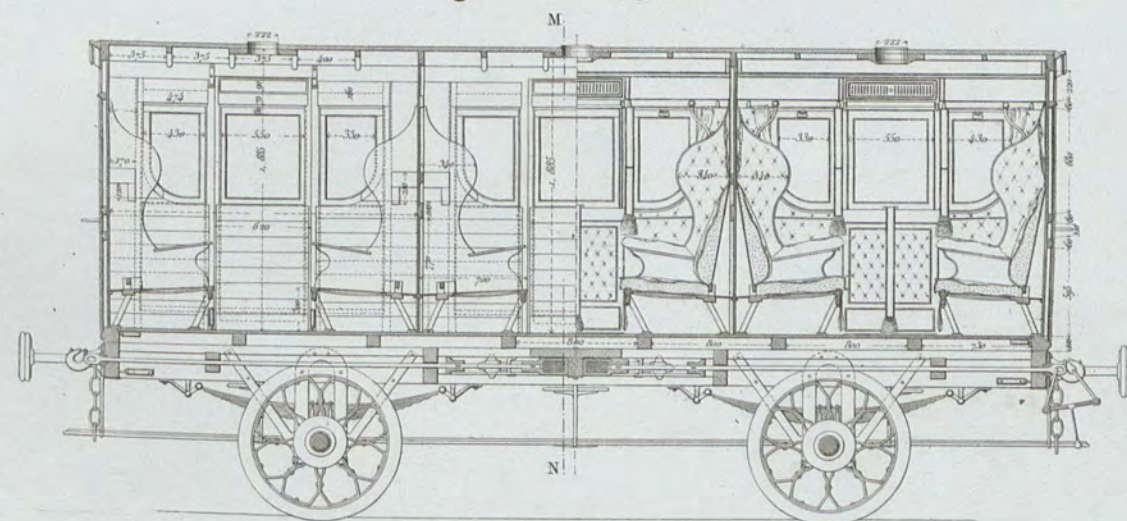

Fig. 1<sup>re</sup>. Vue par bout.

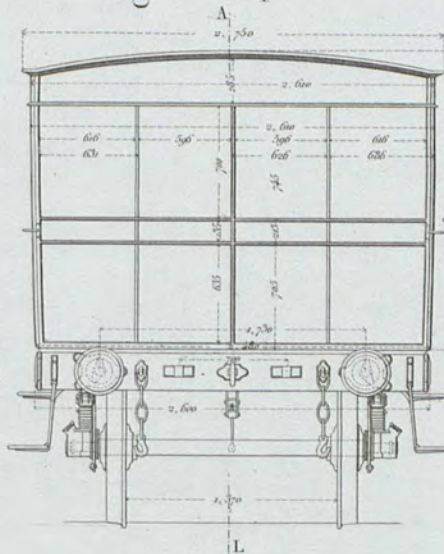

Fig. 2<sup>me</sup>. Coupe longitudinale.

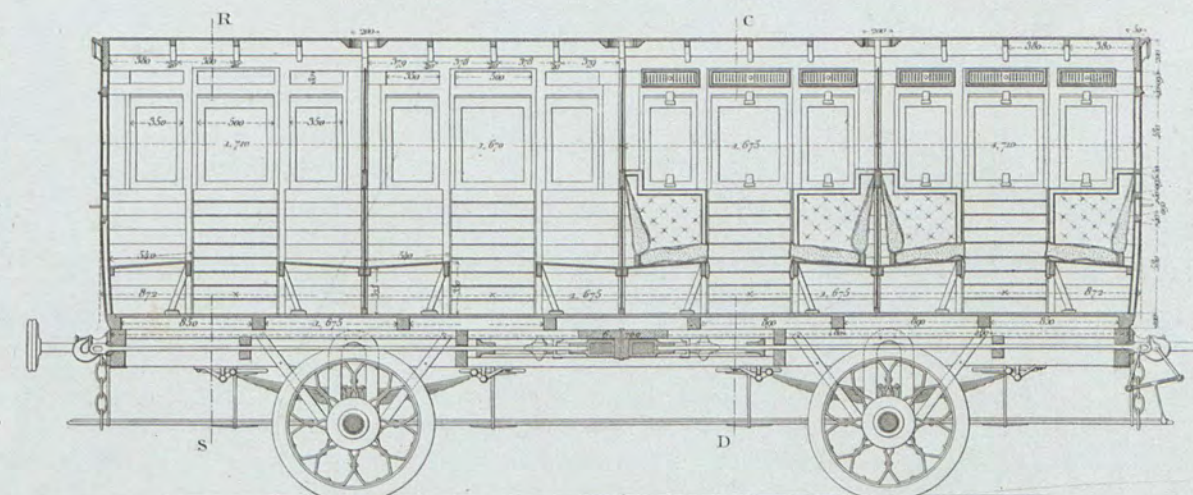

Fig. 1<sup>re</sup>. Plan du chassis.

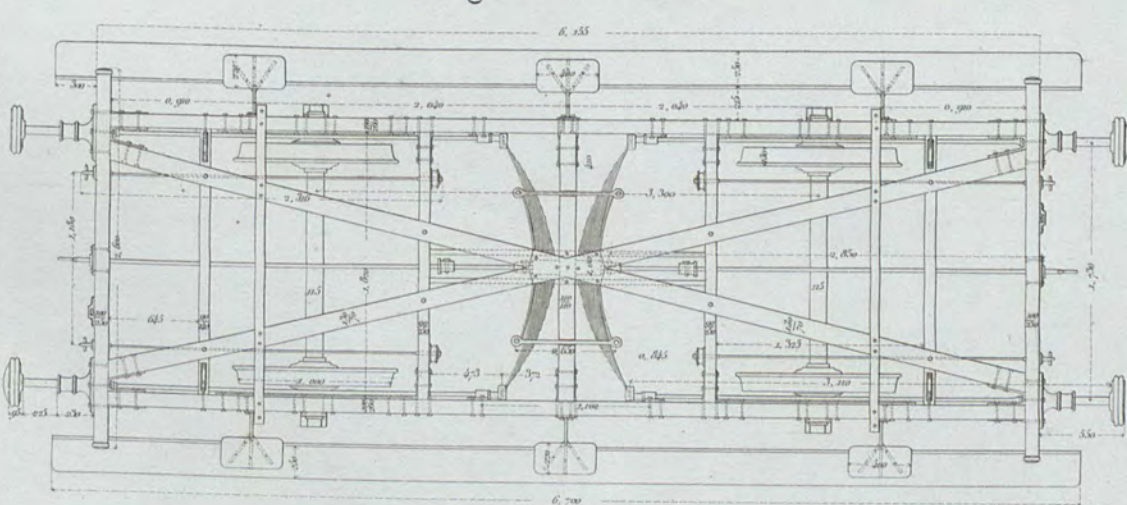

Fig. 2<sup>me</sup>. Coupe transversale.

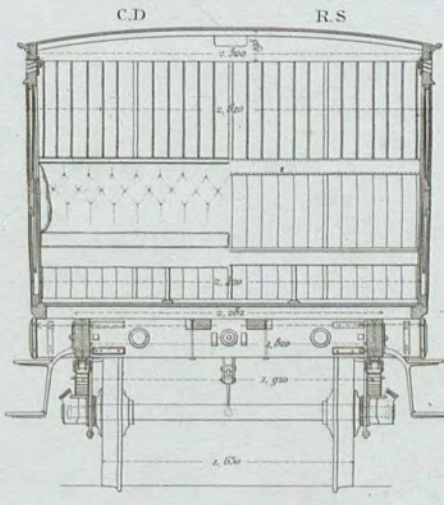
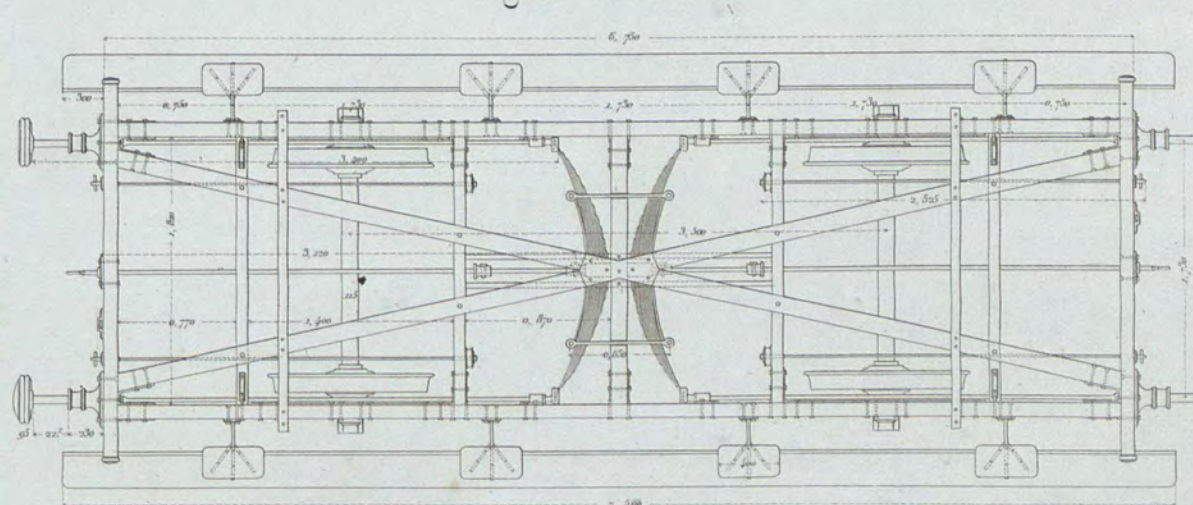
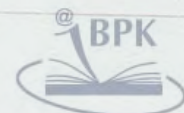

Fig. 2<sup>me</sup>. Plan du chassis.



Echelle 0,02 pour mètre.

A. Jacquin direct.



Imp. P. Charbonnier, 30, r. Bonaparte, Paris.

L. Guiguet del et ac.

Wagon de 2<sup>ème</sup> Classe à impériale.

Fig. 1. Elevation.

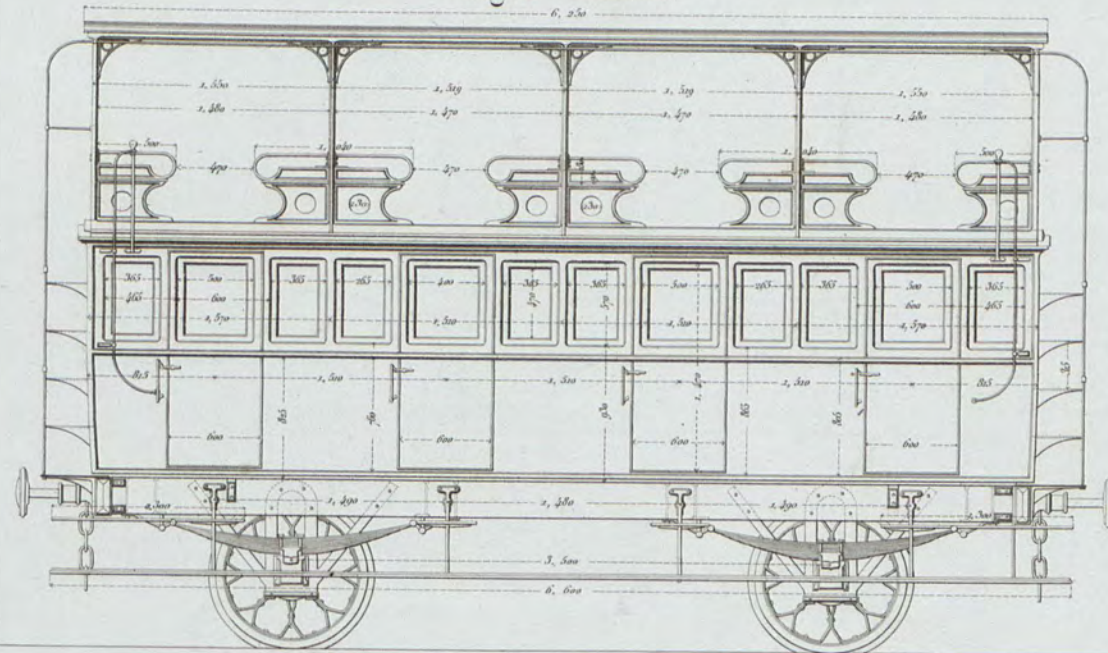
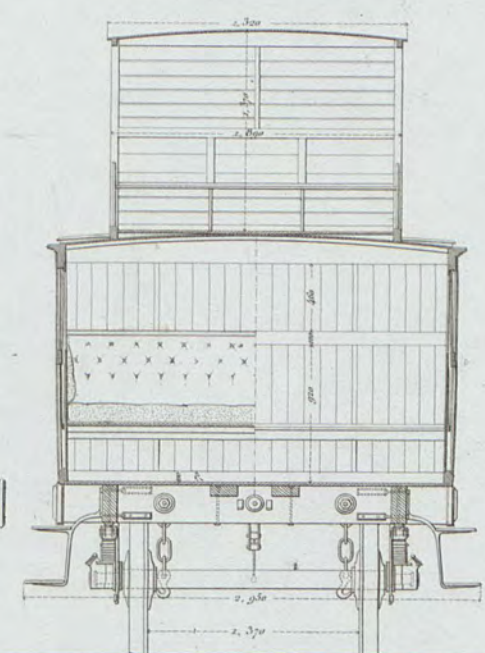

Fig. 1<sup>er</sup>. Coupe transversale.



Wagon de 3<sup>ème</sup> Classe.

Fig. 2. Elevation.

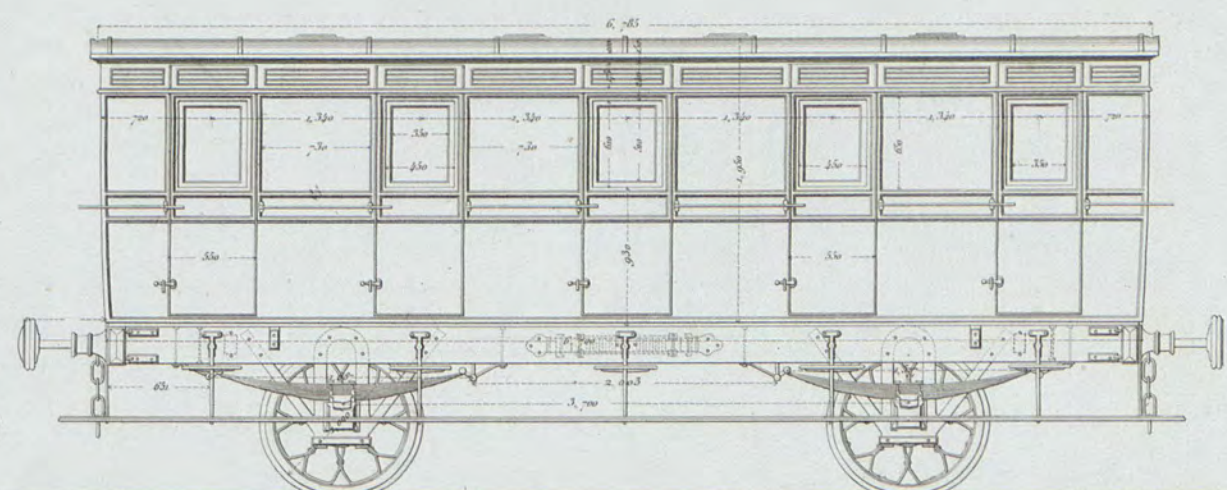

Fig. 1<sup>er</sup>. Coupe longitudinale.

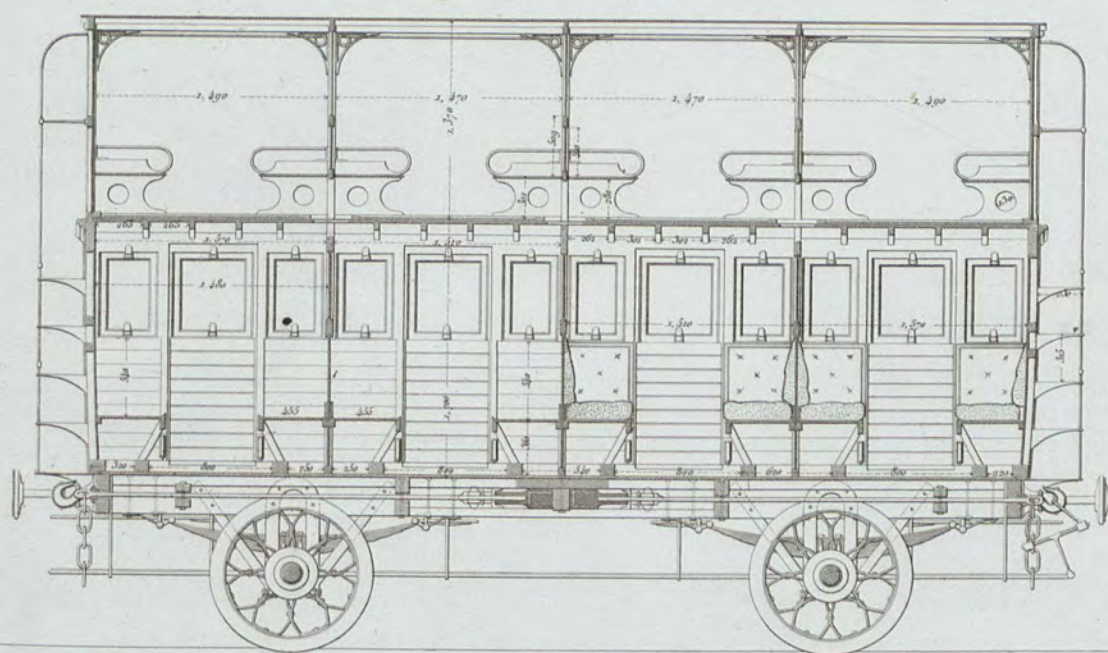

Fig. 1<sup>er</sup>. Vue par bout.

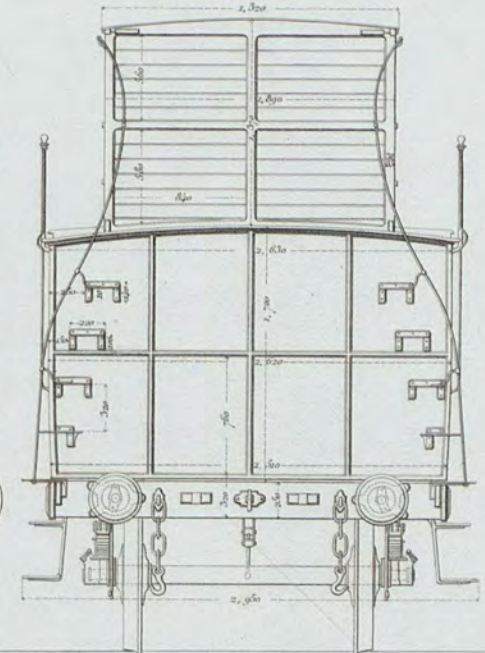

Fig. 2<sup>er</sup>. Coupe longitudinale.

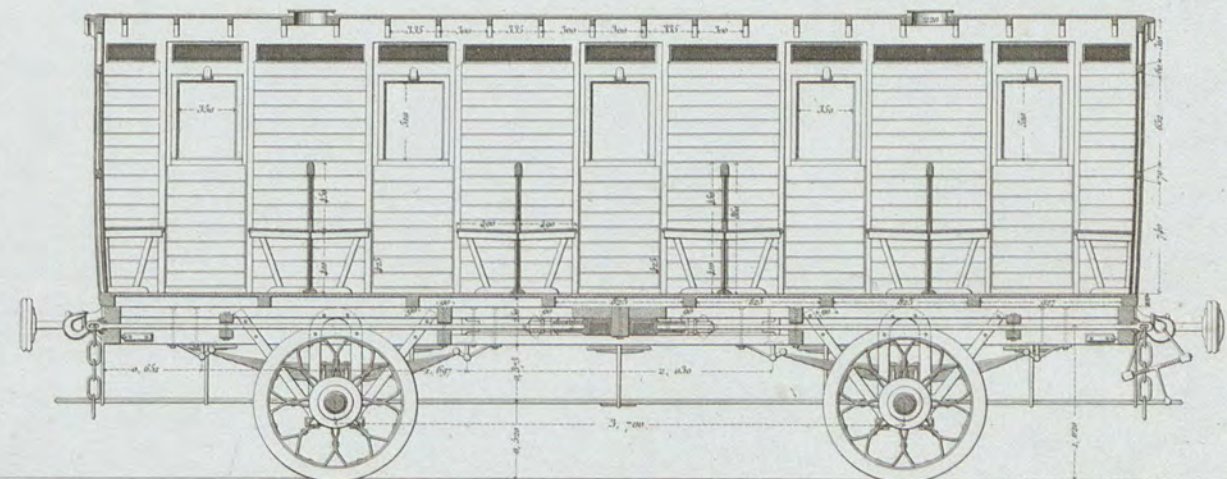

Fig. 1<sup>er</sup>. Plan du chassis.

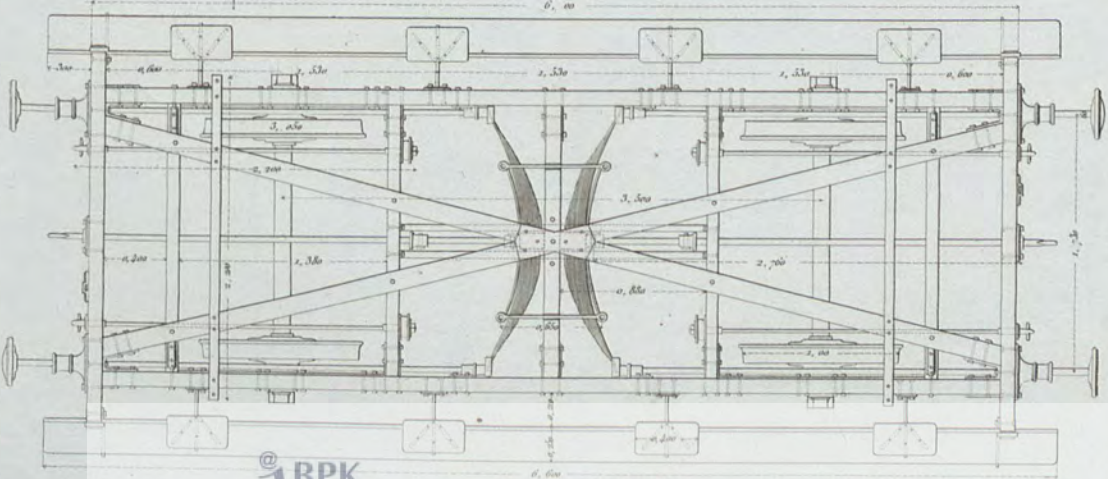

Fig. 2<sup>er</sup>. Coupe transversale. Fig. 2<sup>er</sup>. Vue par bout.

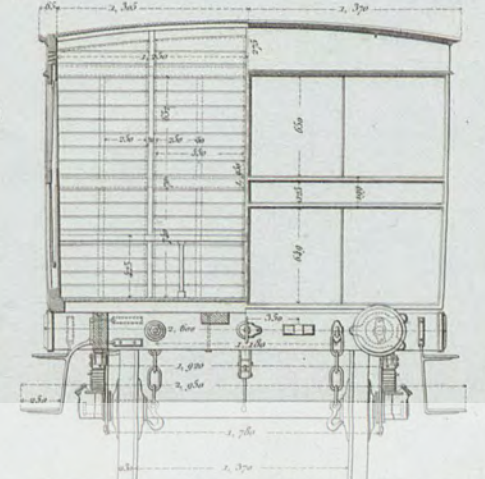

Fig. 2<sup>er</sup>. Plan du chassis.

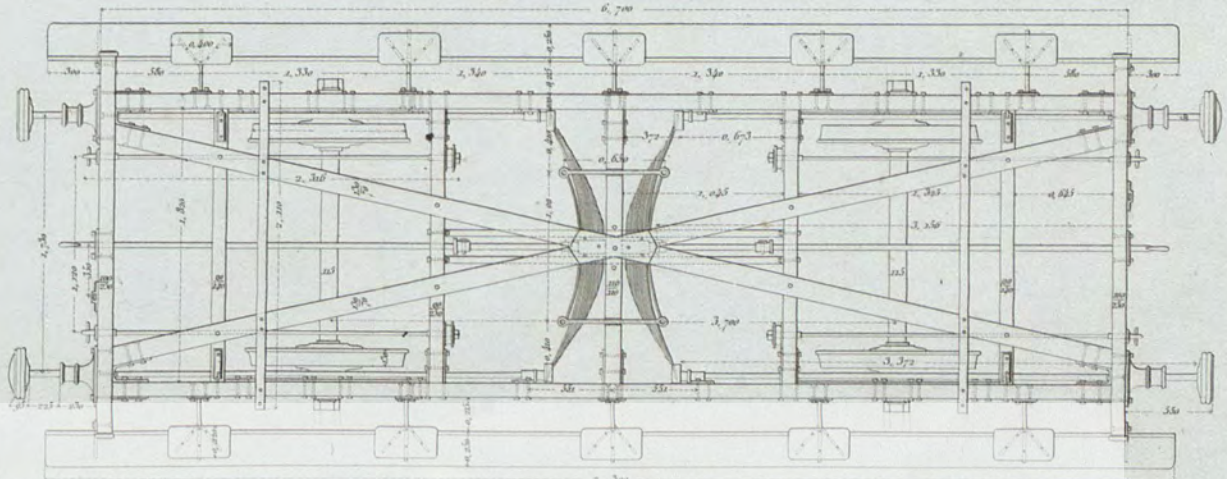

Fig. 2. Coupe transversale du Salon d'honneur.

Echelle de 0,04 pour mètre.

Fig. 3. Coupe longitudinale des chambres à coucher.

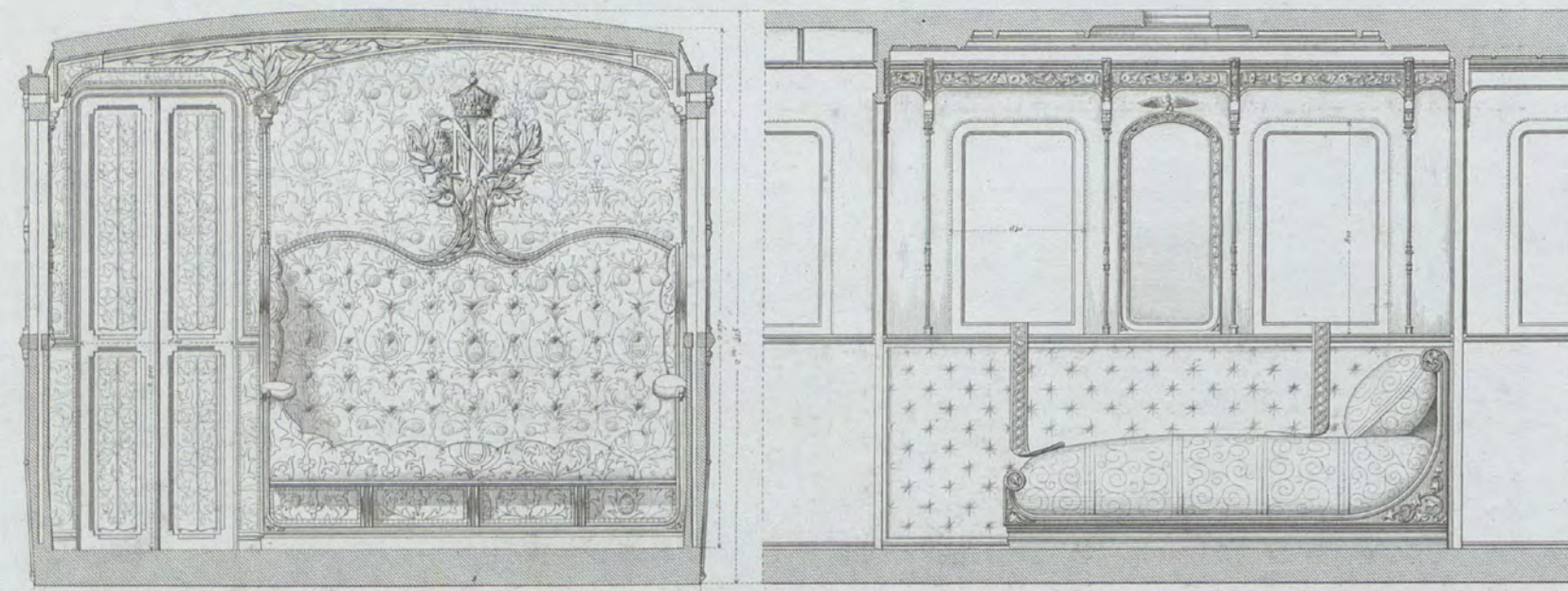

Fig. 1. Elevation générale du train.

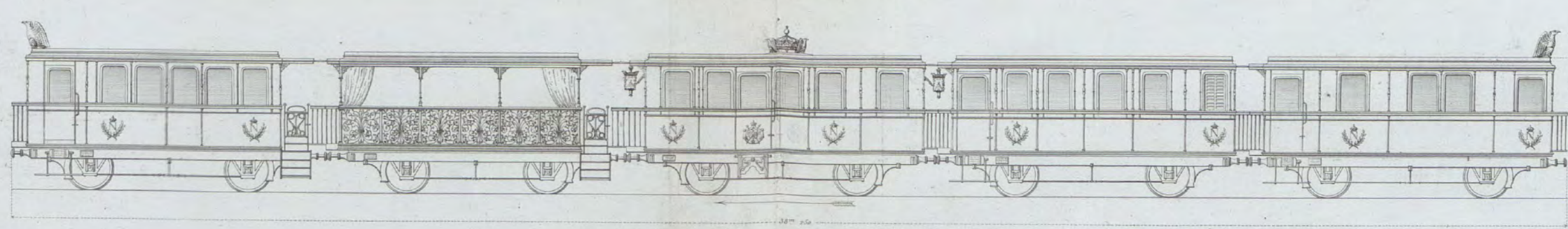

Fig. 1. Plan Echelle 0,01 pour mètre.



Fig. 4. Coupe longitudinale du Wagon plate-forme.

Echelle de 0,04 pour mètre.

Fig. 5. Coupe transversale du Wagon plate-forme.

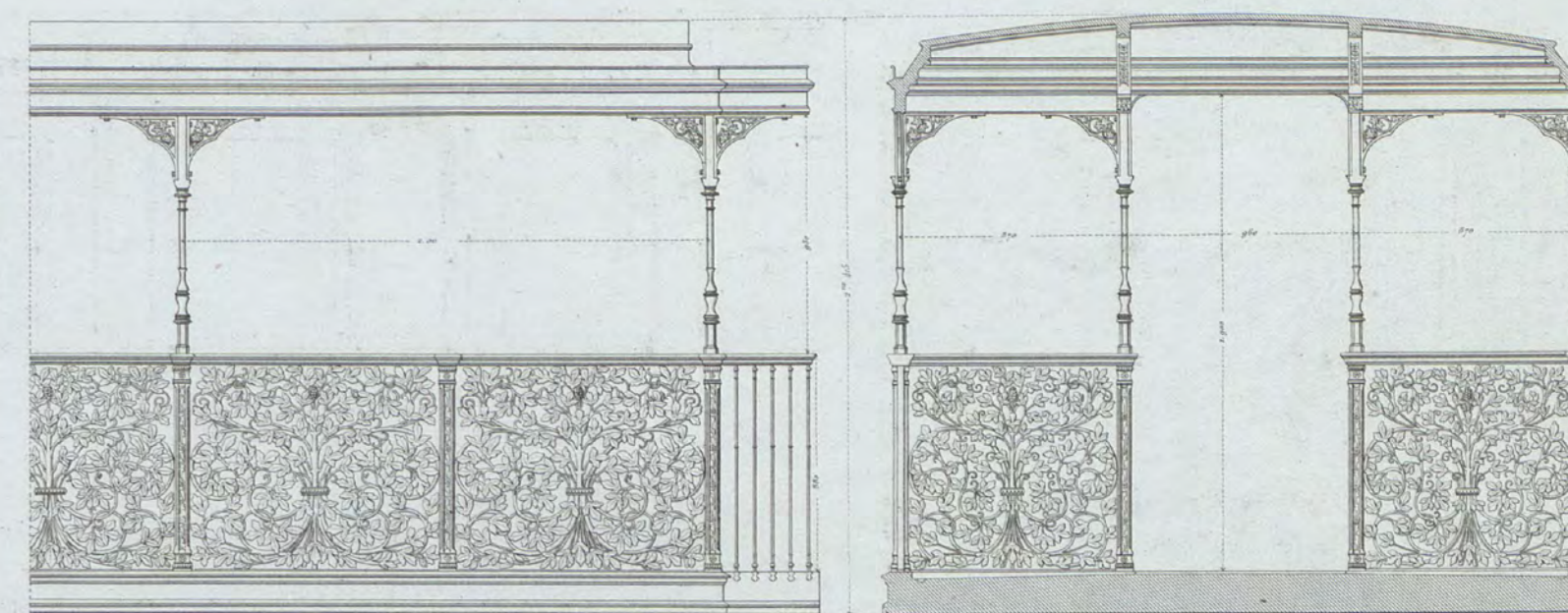

Fig. 7. Arrêt de caisse.

Fig. 8. Supports et étriers des ressorts de caisse.

Fig. 9. Détail d'une palette de l'escalier du Wagon d'honneur.

Fig. 6. Vue par bout

Fig. 6. Chassis du Salon d'honneur et des chambres à coucher

Fig. 6. Coupe transversale.

Fig. 12. Suspension en caoutchouc spéciale au Wagon plate forme.

Fig. 13. Ressort de caisse.

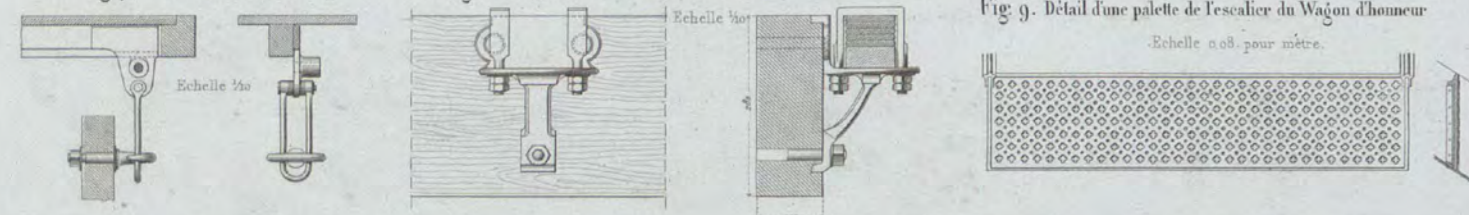

Fig. 10. Escalier du Wagon plate forme et de celui des aides de camp.

Fig. 10. Vue par bout

Fig. 11. Marche-pied du Wagon d'honneur.

Fig. 6. Plan du chassis le plancher étant enlevé.

Fig. 6. Plan du chassis.

Fig. 14. Plaques de garde Echelle 1/10.

Fig. 15. Support de l'entretoise des plaques de garde.

Fig. 16. Boîtes à graisse

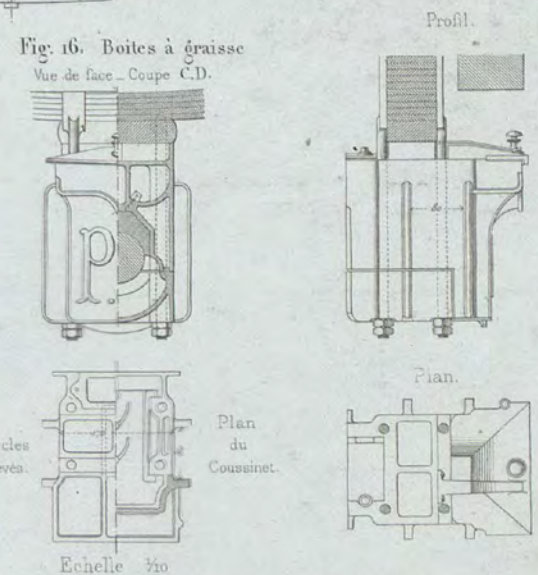
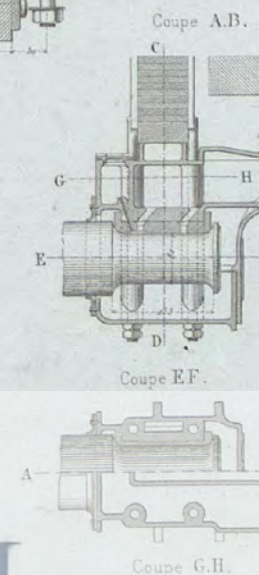
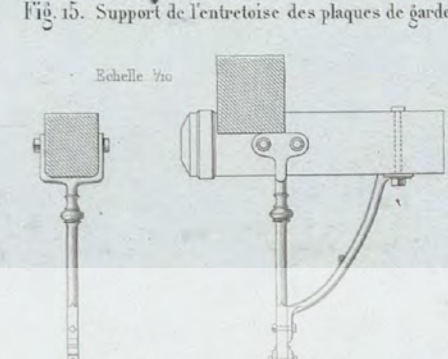
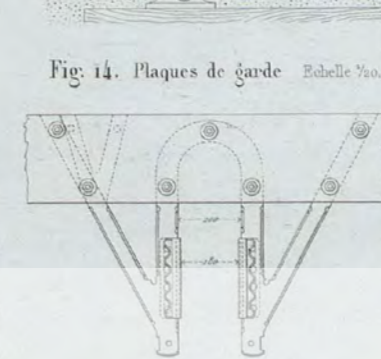
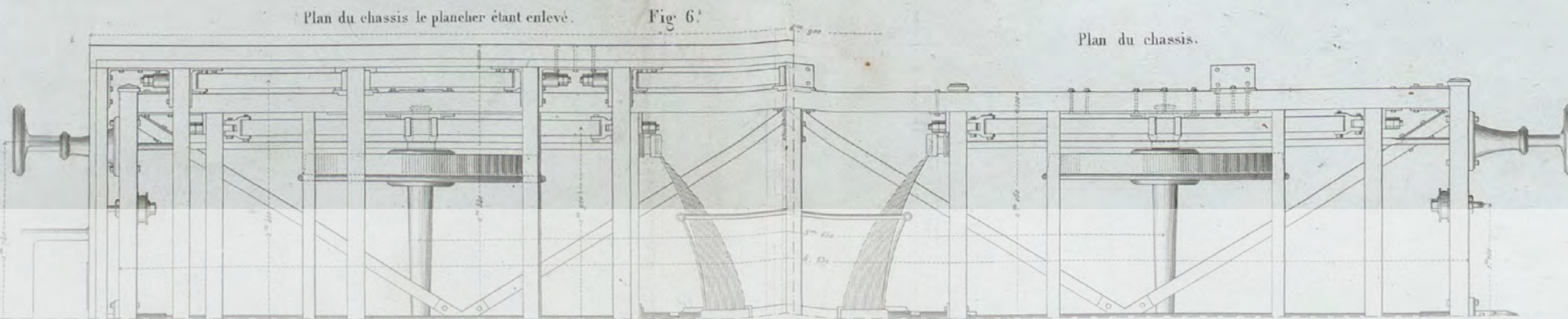
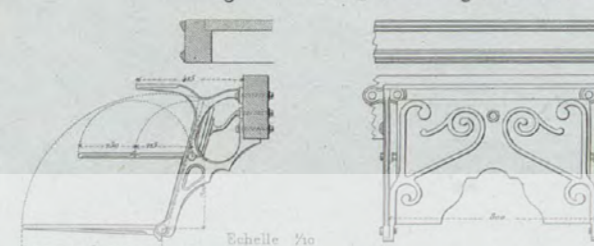
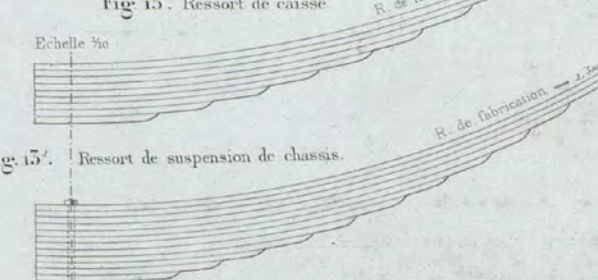
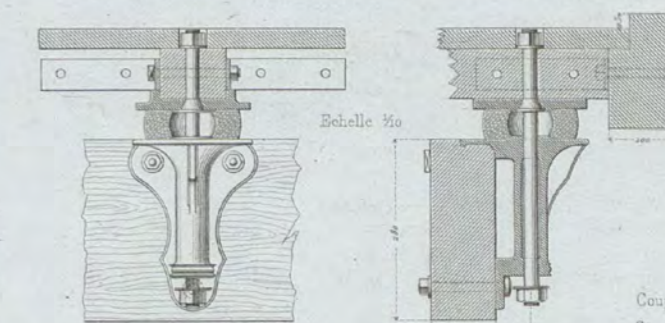
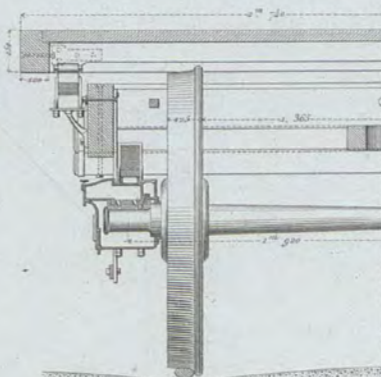
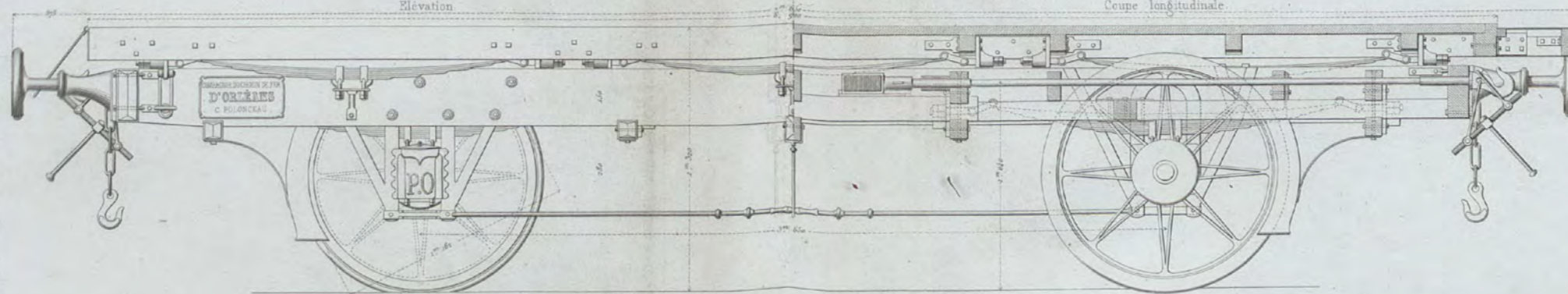
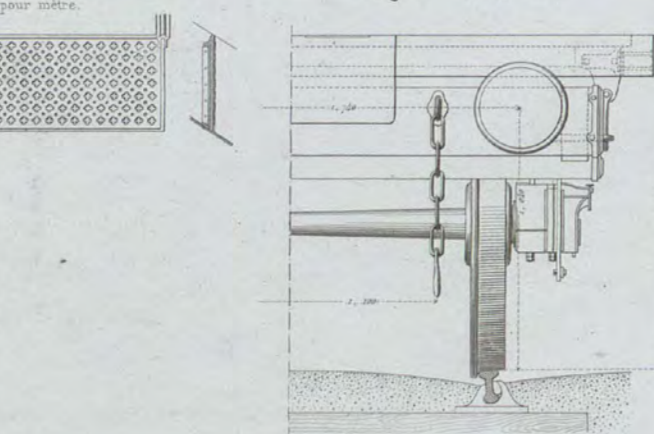
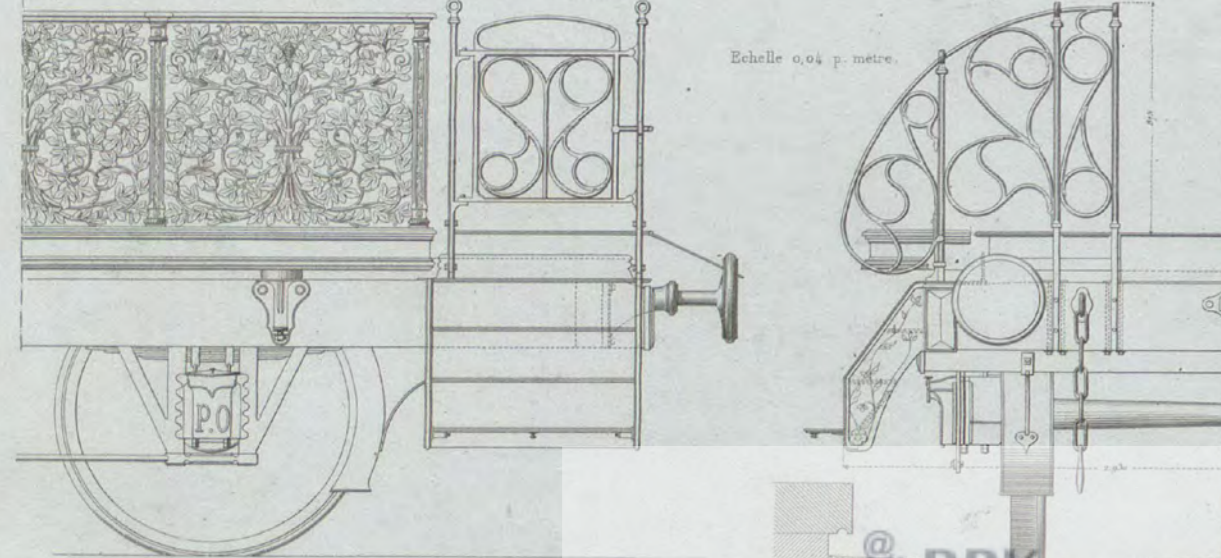

Fig. 1. Elévation. (1<sup>re</sup> Classe)

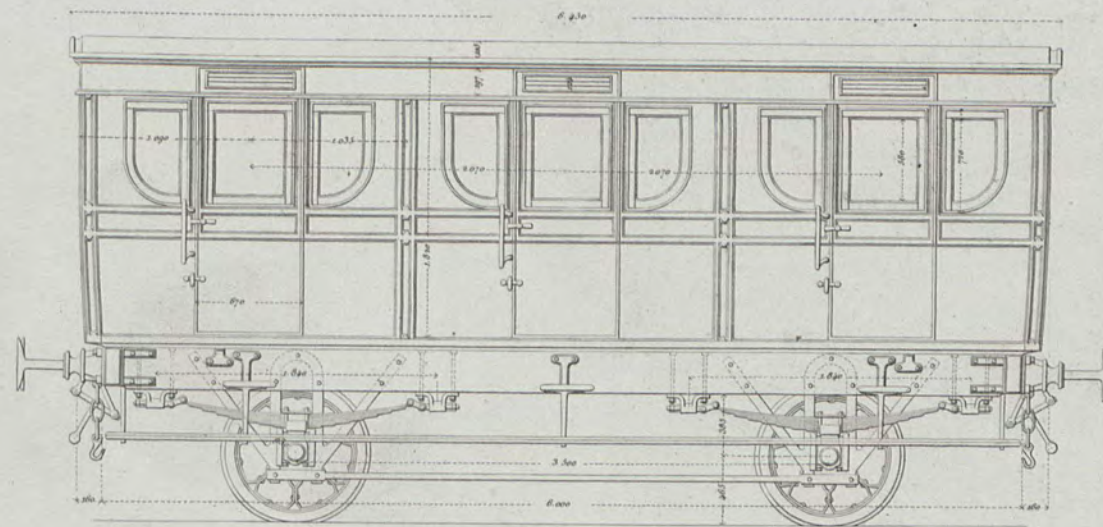

Fig. 1.<sup>3</sup>  
Coupe en travers.

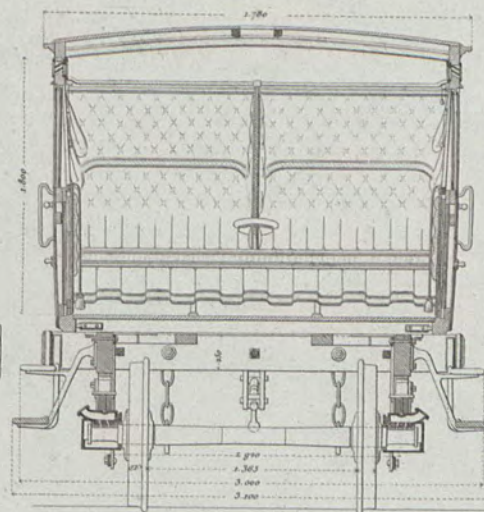

Fig. 2. Elévation. (2<sup>me</sup> Classe)

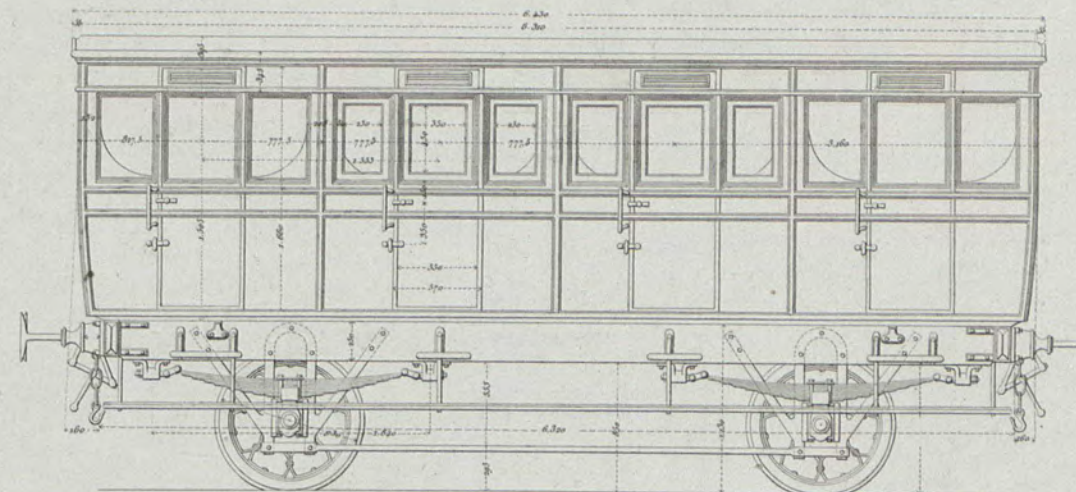

Fig. 1. Coupe longitudinale.

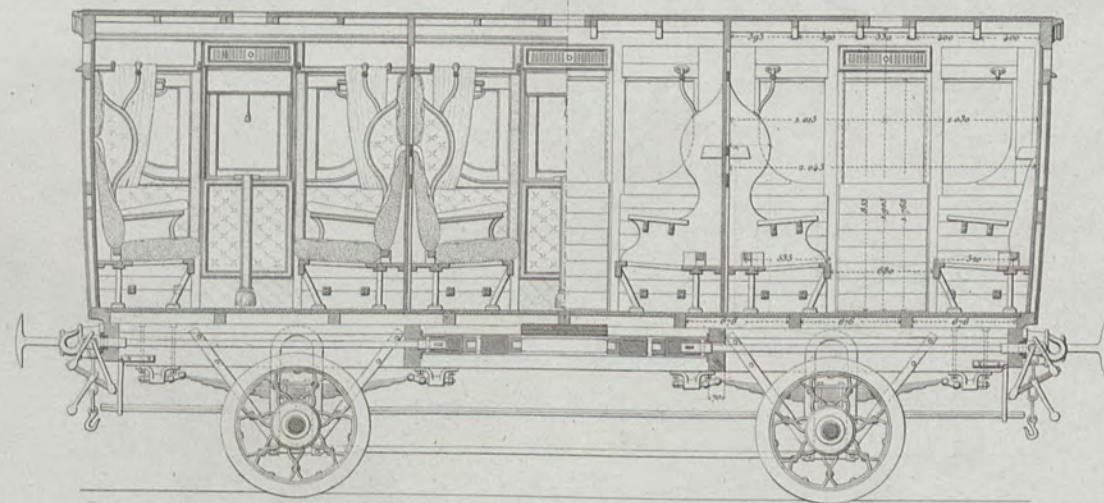

Fig. 1.<sup>4</sup>  
Vue par bout.

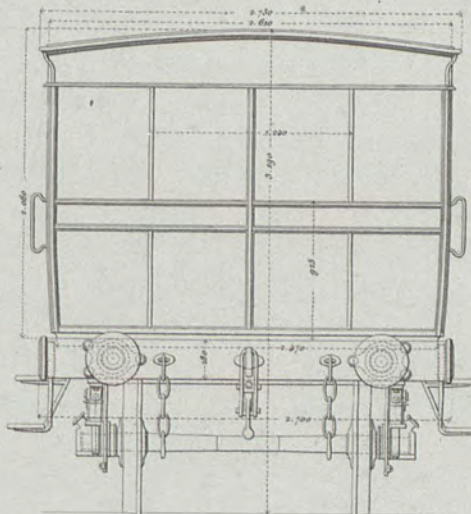

Fig. 2.<sup>1</sup> Coupe longitudinale.

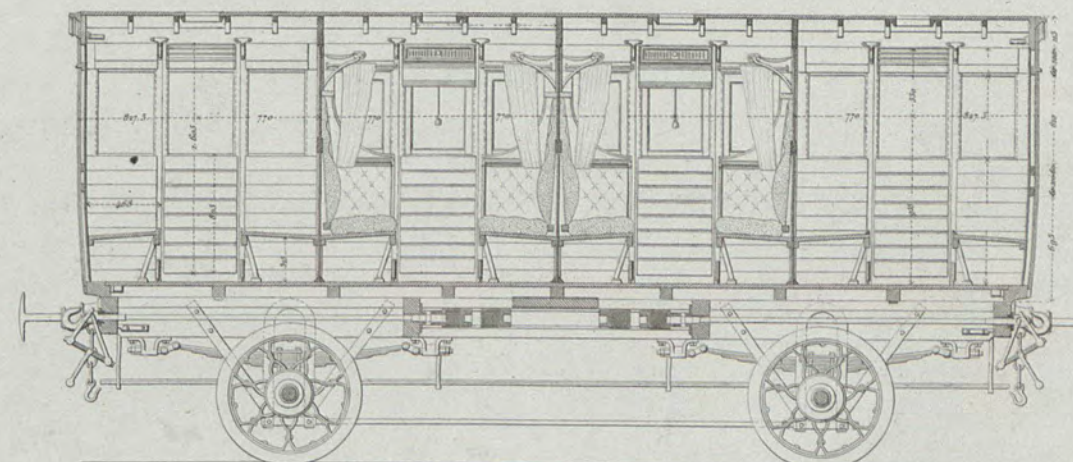

Fig. 1.<sup>2</sup> Plan.

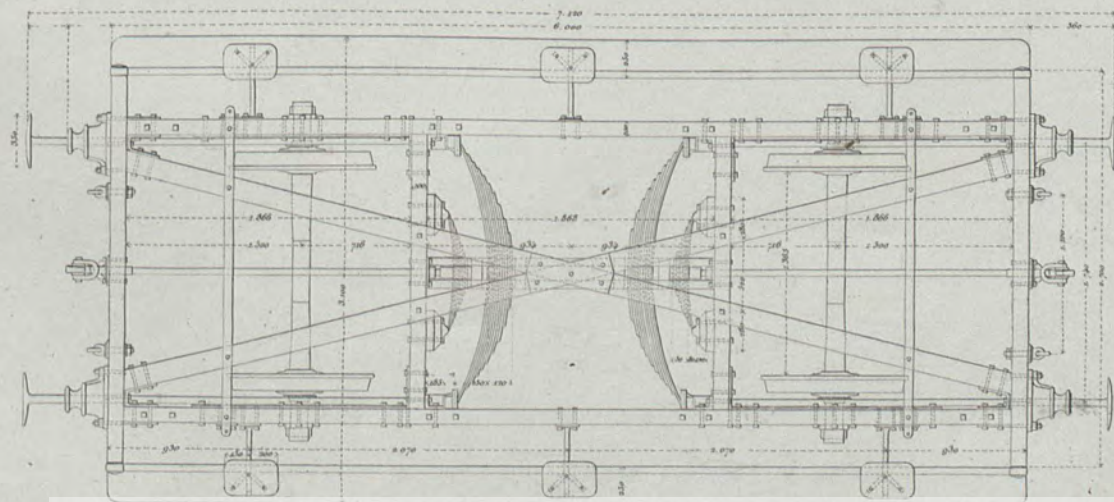

Fig. 2.<sup>2</sup>  
Coupe en travers  
Vue par bout

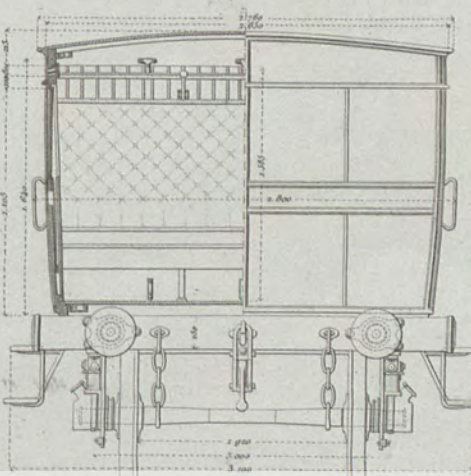

Fig. 2.<sup>2</sup> Plan.

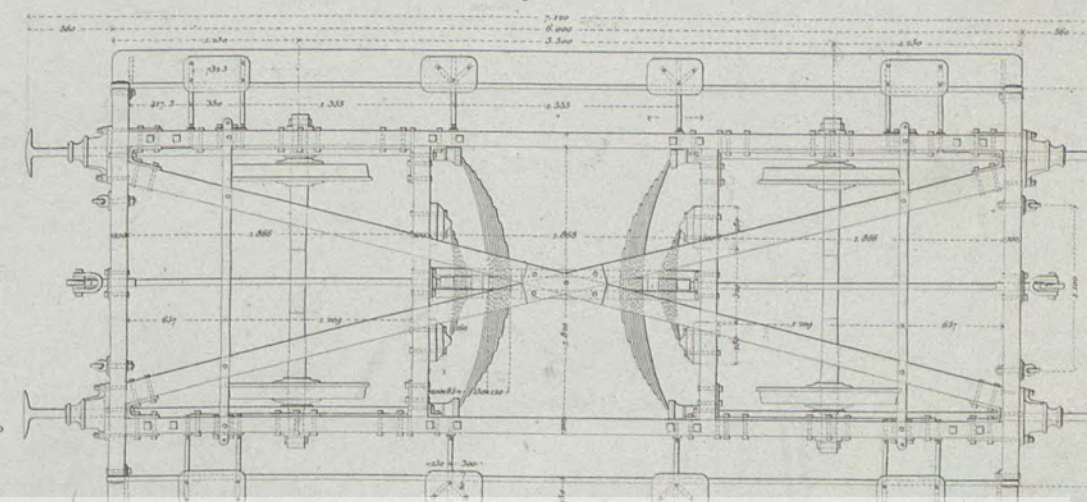

Fig. 1. Elévation.

(Voiture mixte avec frein)

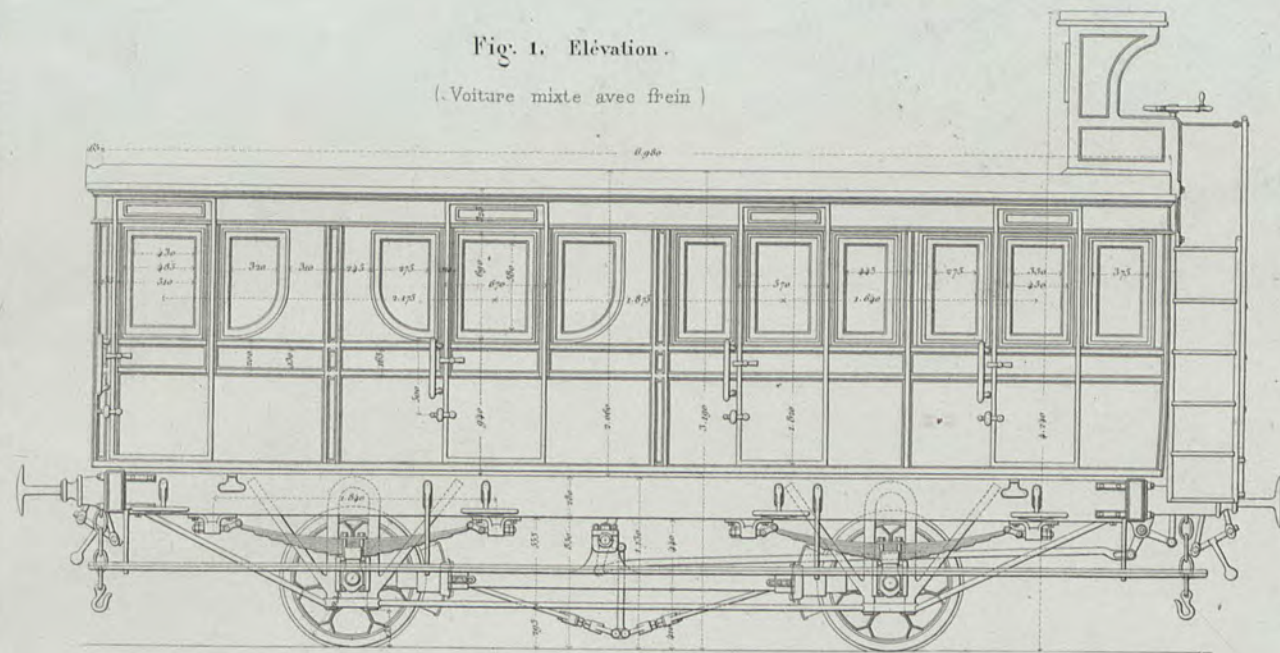

Fig. 1.<sup>2</sup> vue par bout

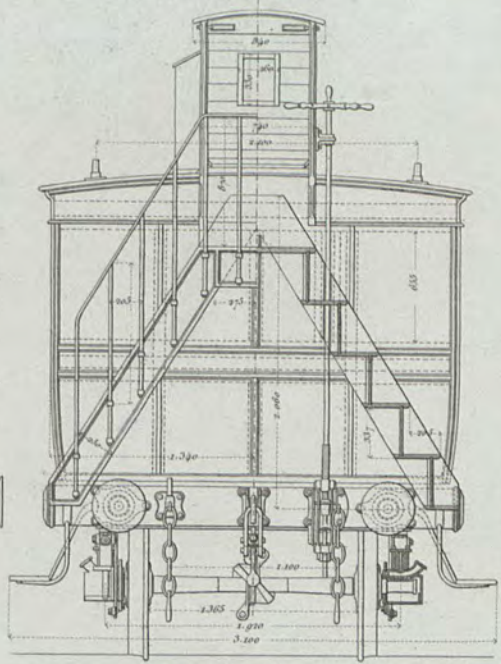

Fig. 2. Elévation.

(3<sup>me</sup> Classe avec frein)

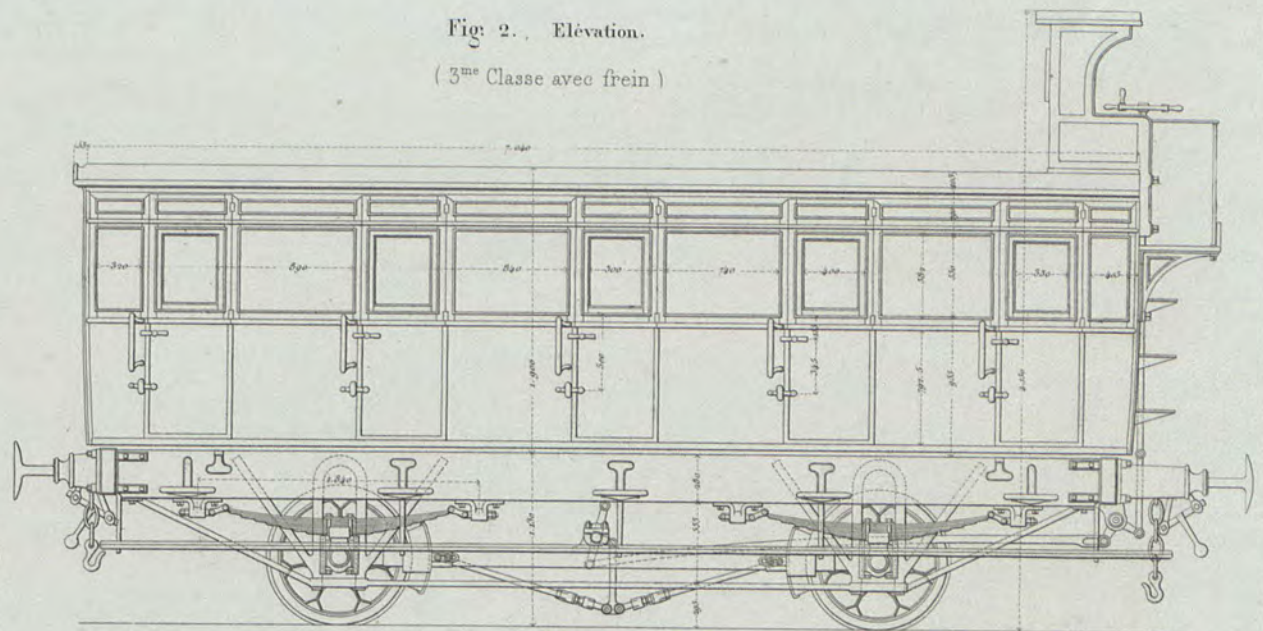

Fig. 1.<sup>3</sup>

Vue par bout Coupe en travers

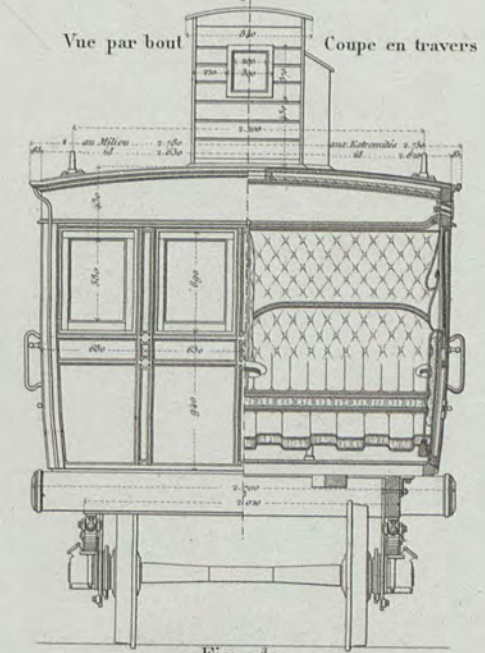

Fig. 2.<sup>3</sup> Coupe longitudinale.

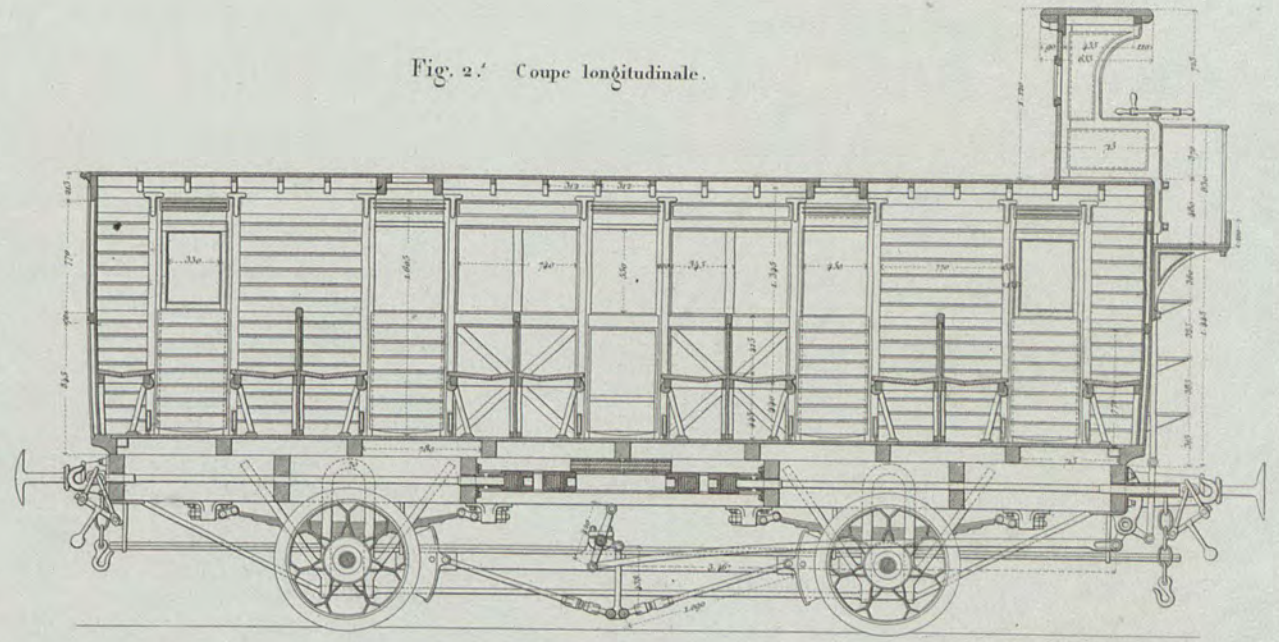

Fig. 1.<sup>4</sup> Coupe longitudinale

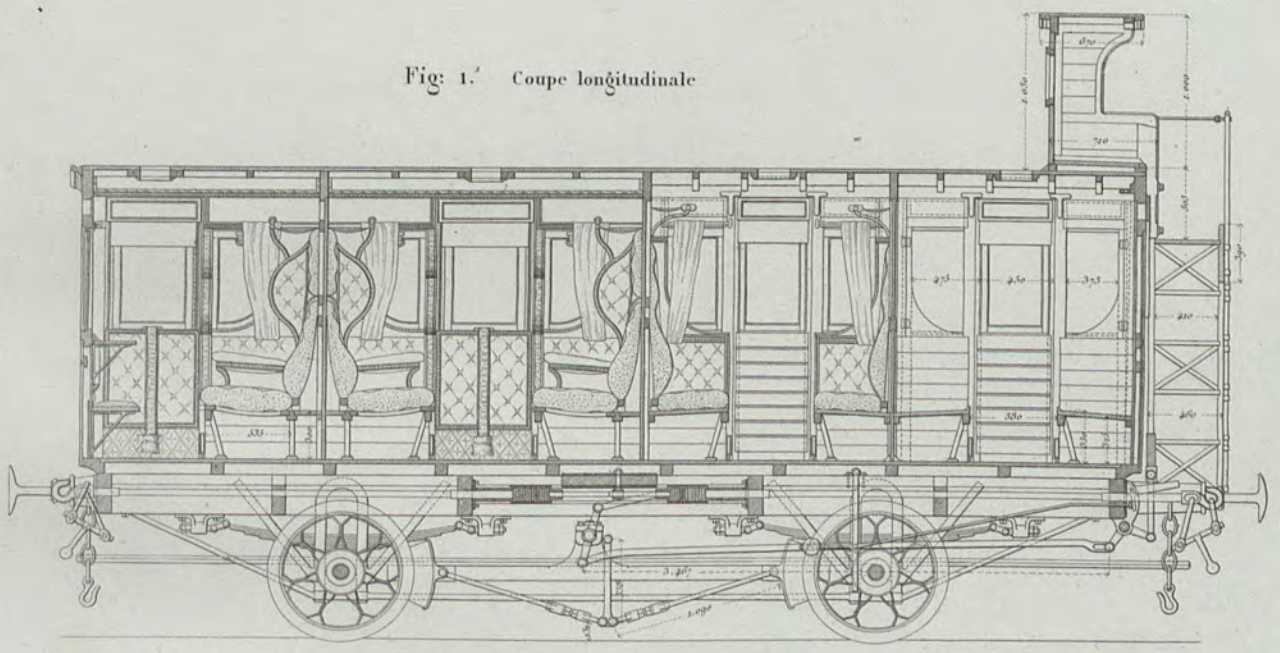

Fig. 1.<sup>5</sup> Plan

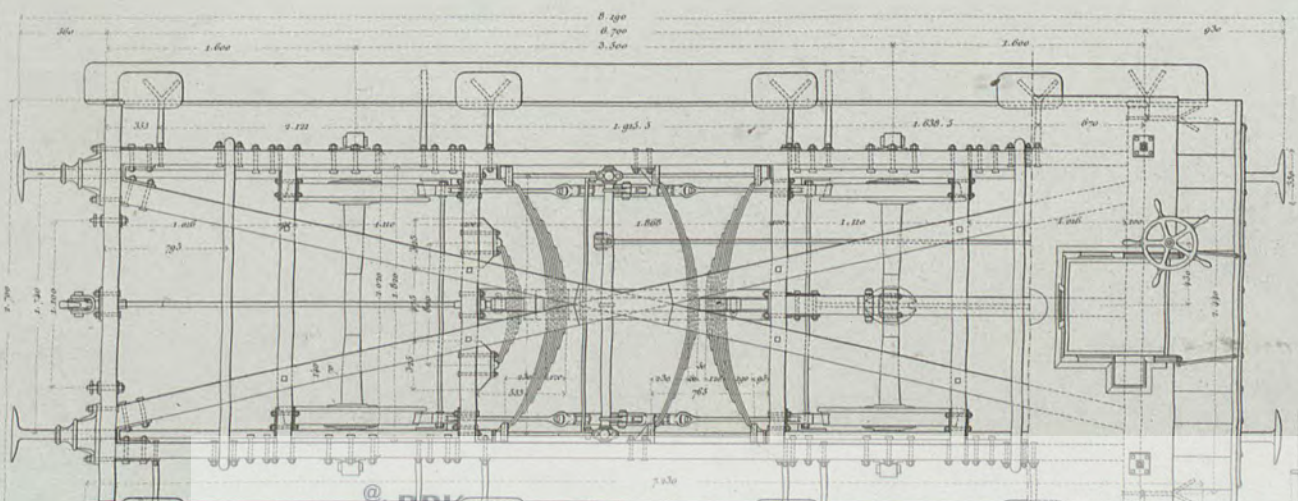

Fig. 2.<sup>4</sup> Coupe de travers vue par bout

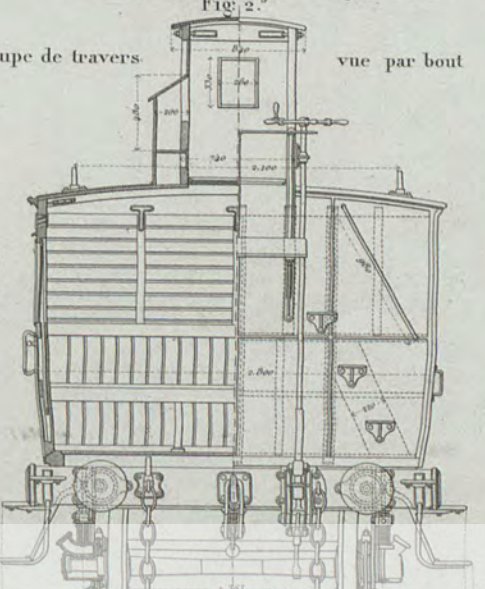
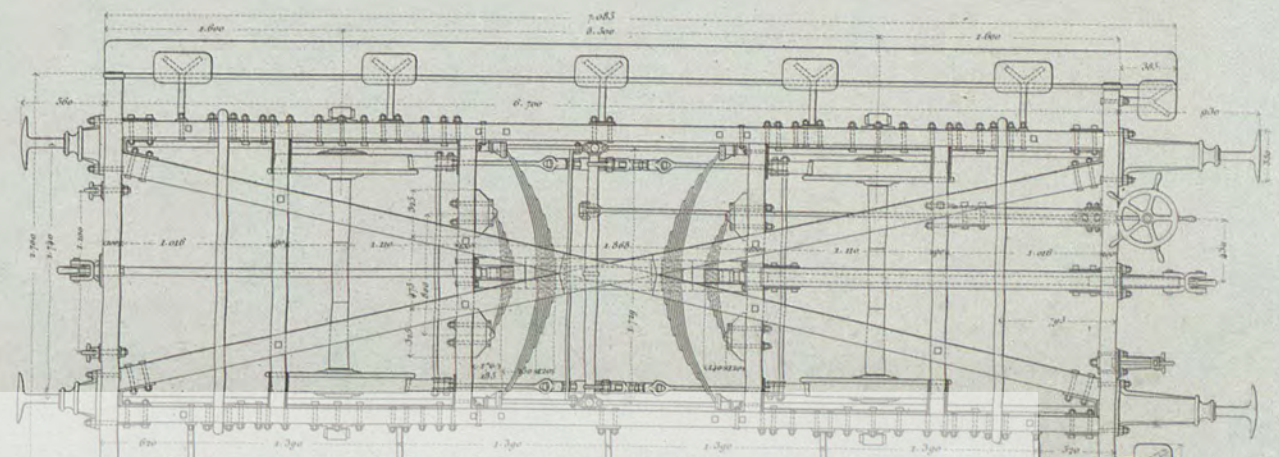

Fig. 2.<sup>5</sup> Plan





Chemins de fer d'Orléans.

Fig. 1. Élévation.

Fig. 1'. Coupe longitudinale.

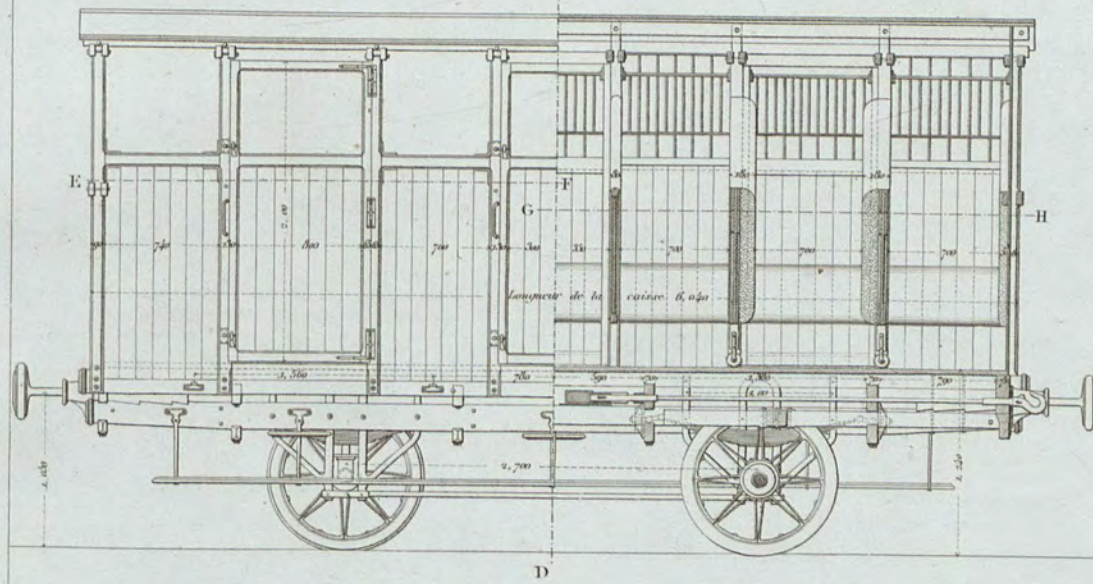
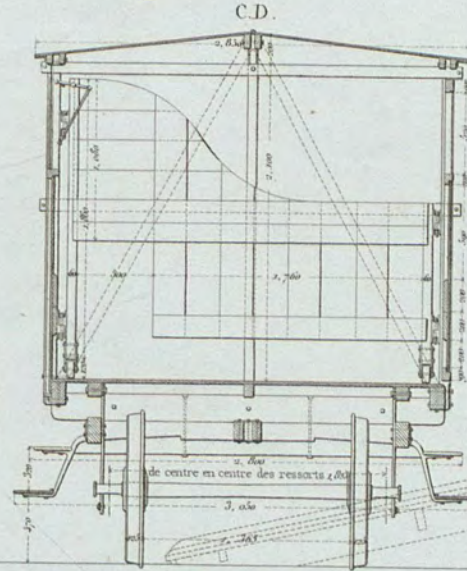

Fig. 1<sup>d</sup>. Coupe transversale.



Chemins de fer Belges.

Fig. 2'. Coupe longitudinale.

Fig. 2. Élévation.

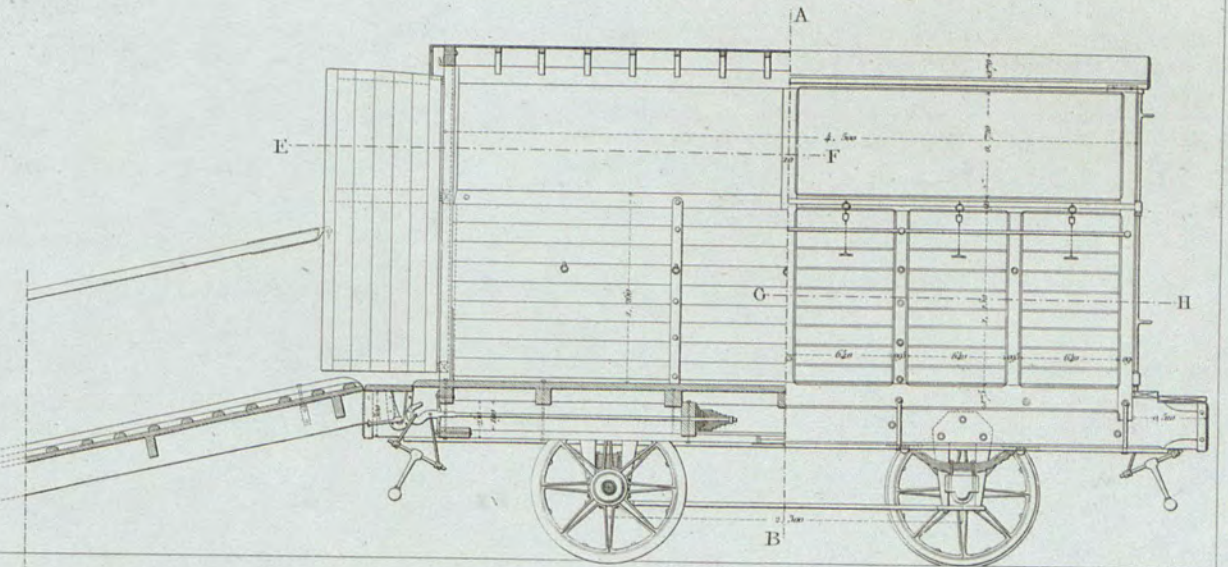

Plan.

Fig. 1<sup>2</sup>. Plan du chassis et Coupe E.F.

Fig. 1<sup>3</sup>. Coupe horizontale .G.H.

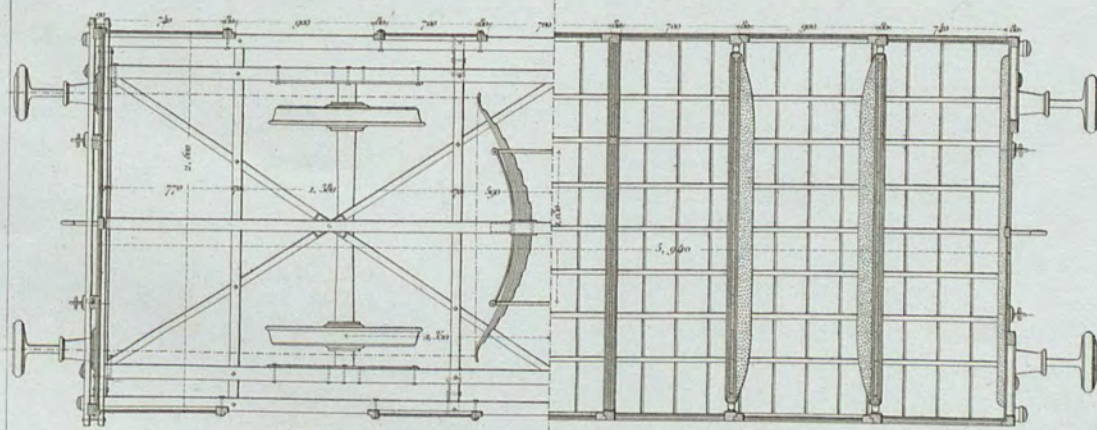

Fig. 2<sup>d</sup>. Coupe transversale.

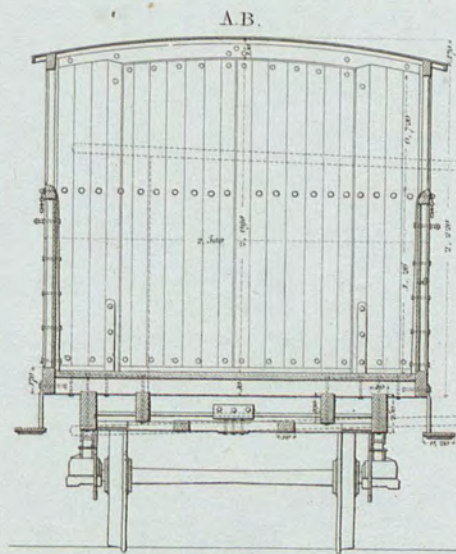

Fig. 2<sup>2</sup>. Coupe horizontale .E.F.

Fig. 2<sup>3</sup>. Plan du chassis .G.H.

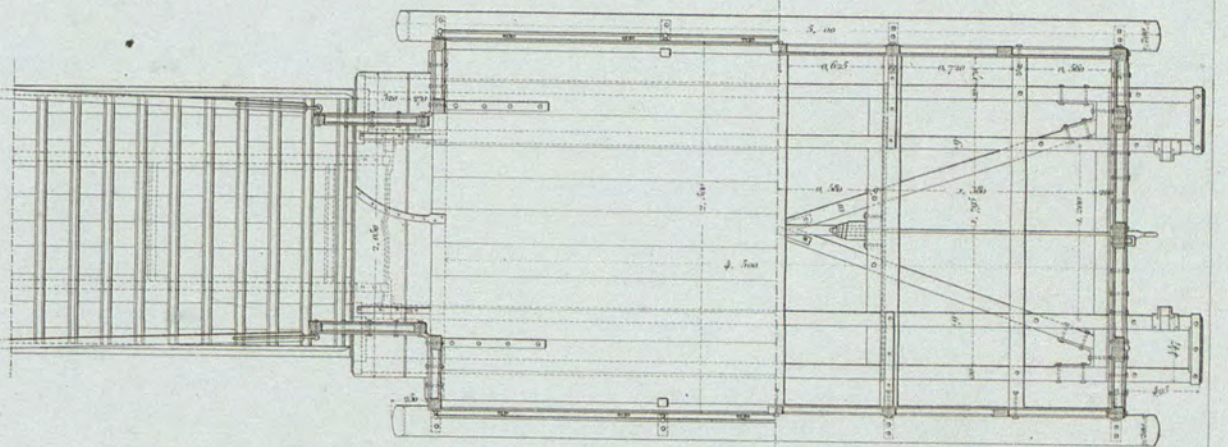
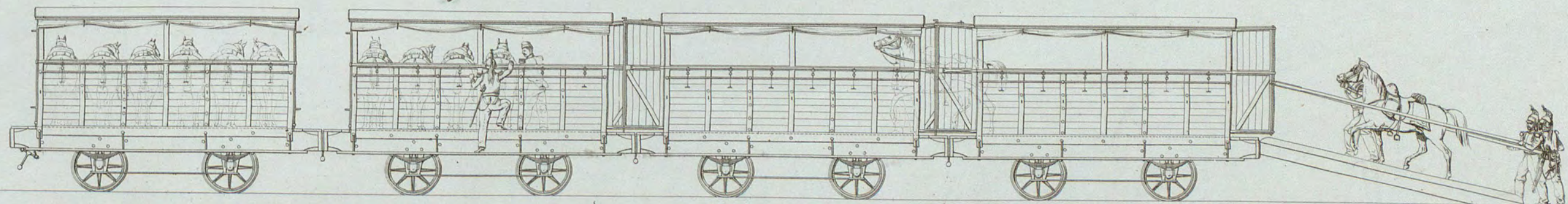
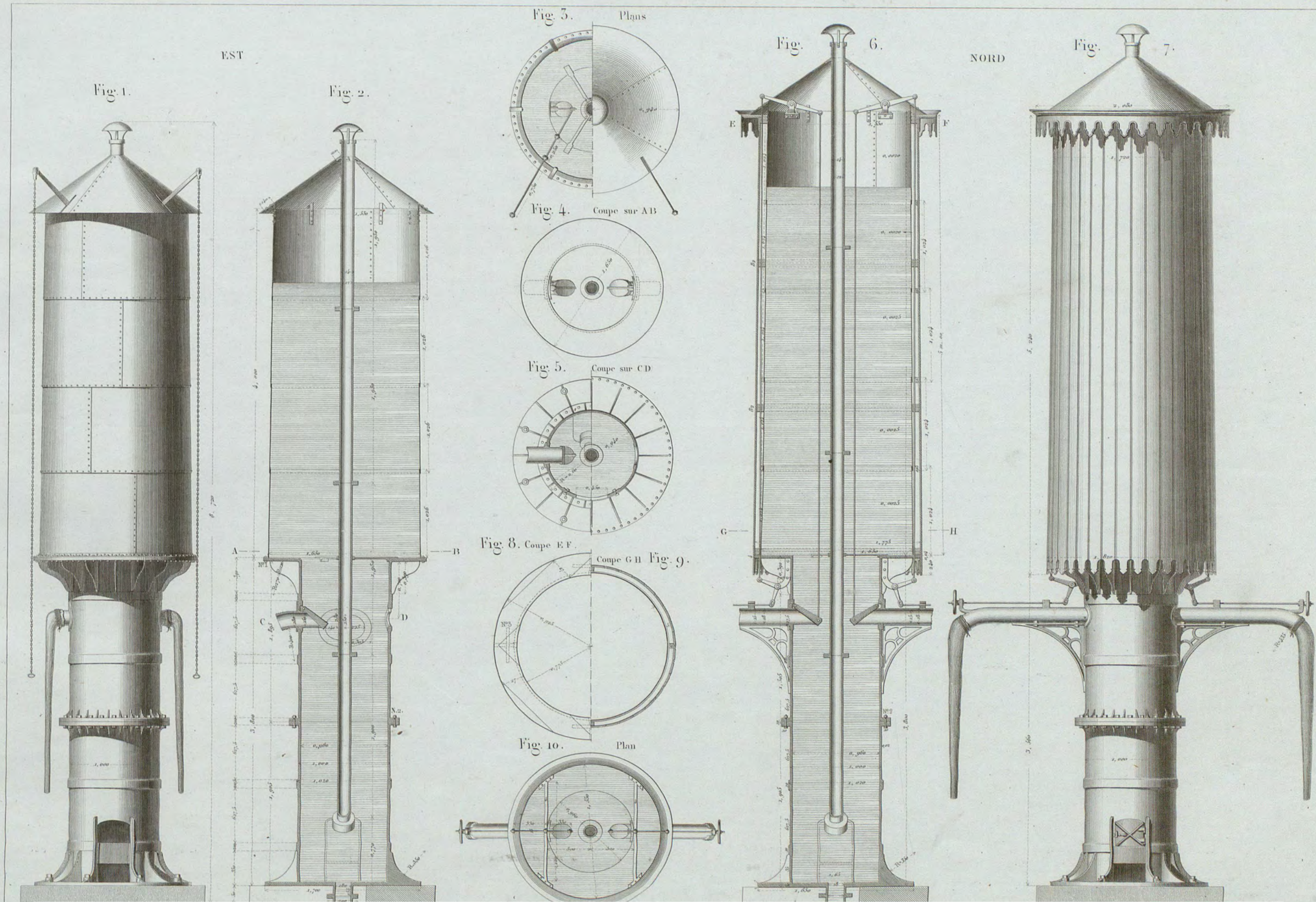

Fig. 3. Ensemble d'un Train Belge pour le transport de la Cavalerie.



Echelle des Fig. 1 et 2, 0, 02 pour mètre.

Echelle de la Fig. 3, 0, 01 pour mètre.



Echelle de 0,0025 p<sup>r</sup> 1 met.

A. Jacquin dire<sup>c</sup>t



Imp. F. Chardon aîné, Soc. r. Montreuil, Paris.

L. Guignot del. et sculp.

Fig. 1. Coupe sur l'axe (partie supérieure).

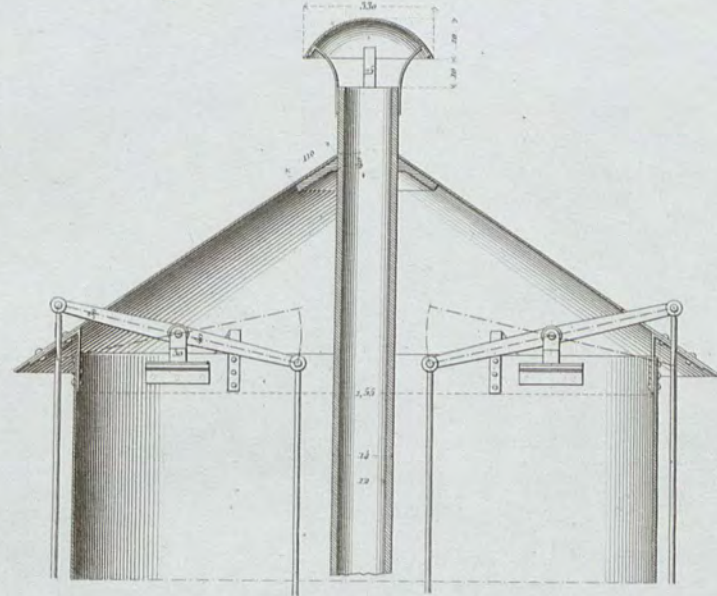

Fig. 13. Coupe sur A.B.

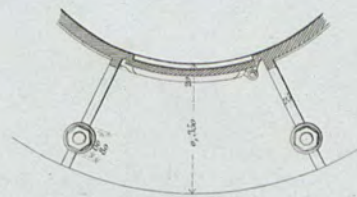

Fig. 2. Elevation (partie inférieure).

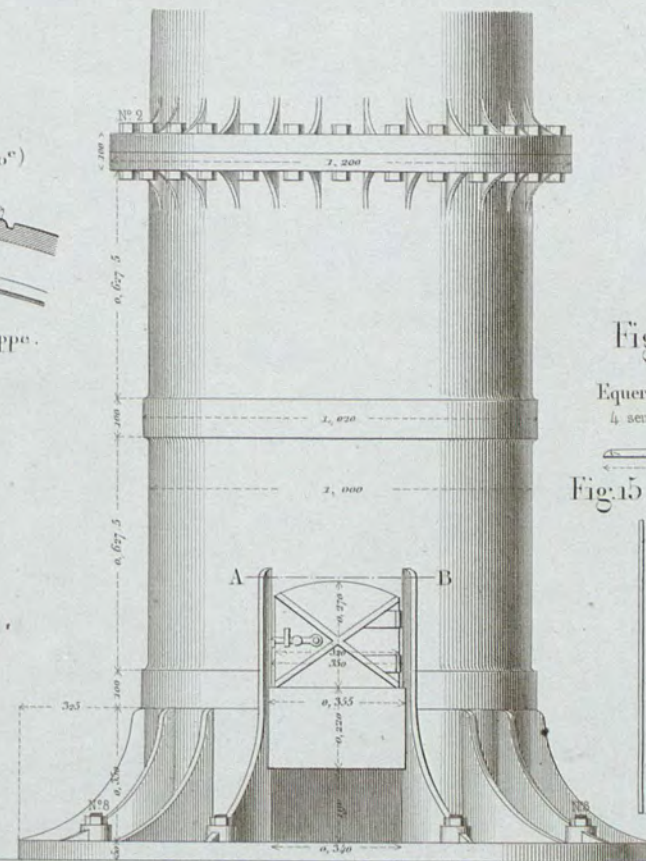

Fig. 4. Plan des fondations.

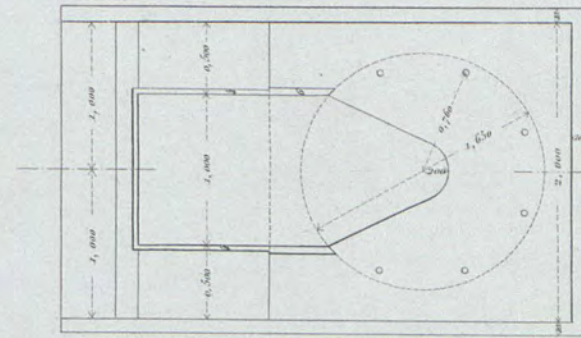

Fig. 20.

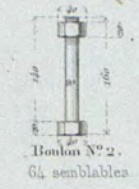

Fig. 21.



Fig. 12. Détail de l'enveloppe (1/10°)

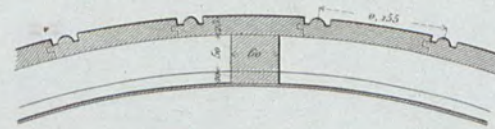

Fig. 12¹ Partie inférieure de l'enveloppe.

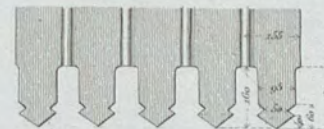

Fig. 11. Lambrequin

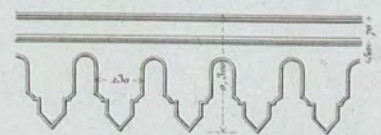

Fig. 3. Coupe sur l'axe (partie inférieure).

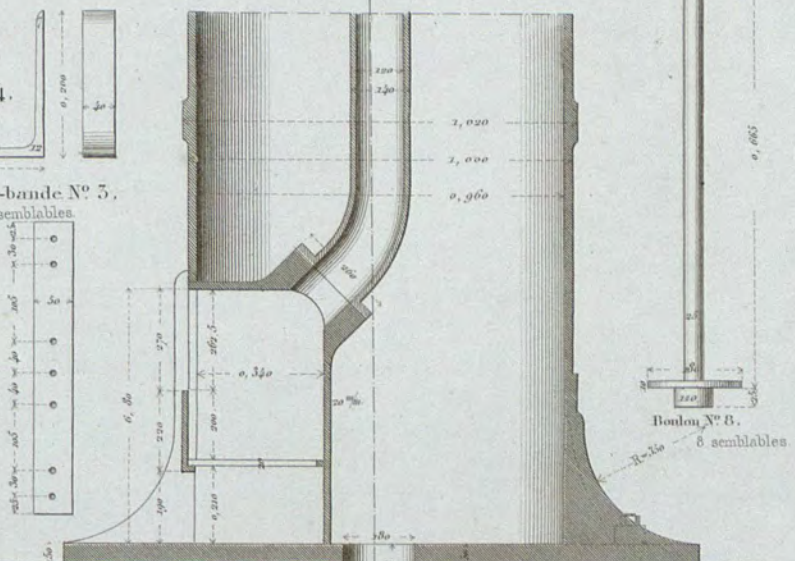

Fig. 14.

Equerre N° 4. 4 semblables.

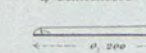

Fig. 15. Plate-bande N° 5. 4 semblables.

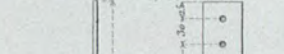
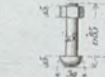

Fig. 16.



Boulon N° 1. 62 semblables.

Fig. 17.



N° 6. 2 semblables.

Fig. 18.



N° 5. 14 semblables.

Fig. 19.



N° 7. 2 semblables.

Coupe suivant C.D.

Fig. 7.

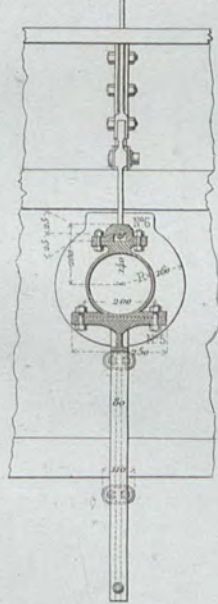

Fig. 5. Elevation de la prise d'eau.

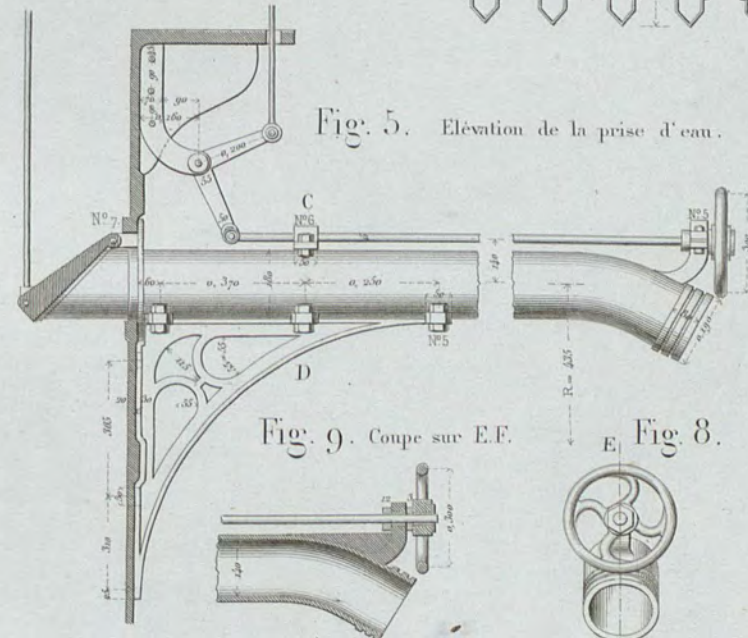

Fig. 9. Coupe sur E.E.

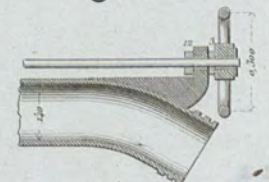

Fig. 8.



Fig. 10. Détail de l'attache du Lambrequin.

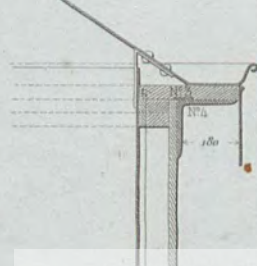
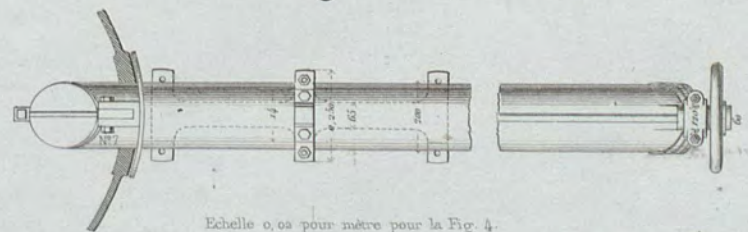

Fig. 6. Plan.



Echelle 0,05 pour mètre pour la Fig. 4.

Longueur variable avec la largeur de l'entrevoie.

Echelle 0,05 pour mètre.

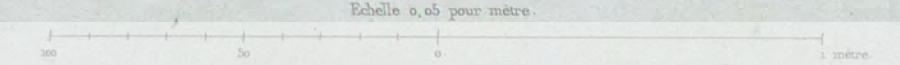
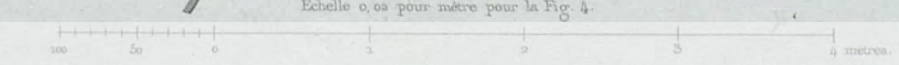

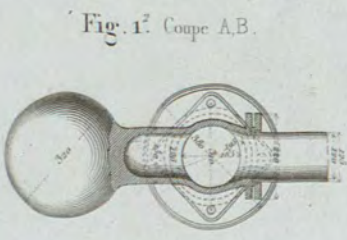

Fig. 1.2 Coupe A.B.

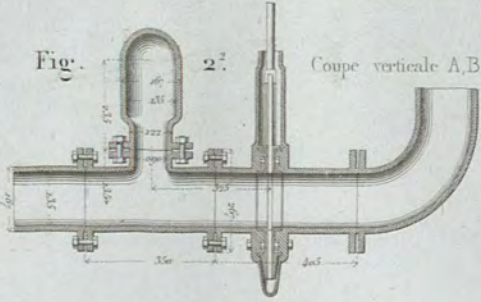

Fig. 2. Coupe verticale A.B.

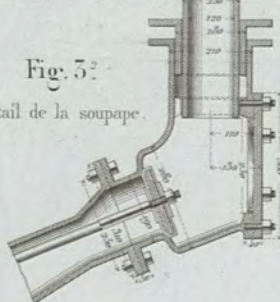

Fig. 3.2 Détail de la soupape.

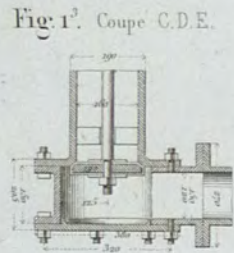

Fig. 1.3 Coupe C.D.E.

Grue hydraulique à colonne. (Est.)

Fig. 2. Elevation.



Grue applique. (Orléans) Fig. 3. Elevation.

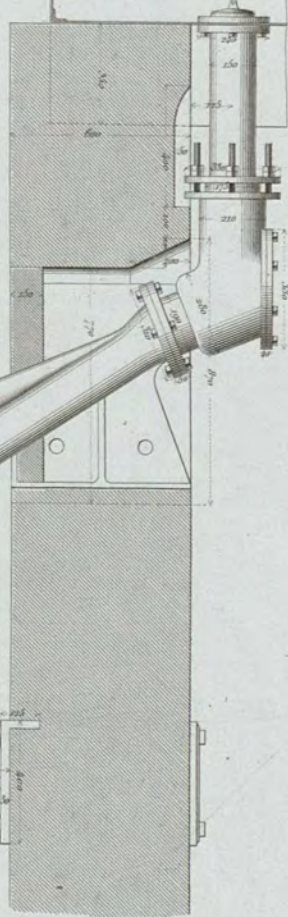
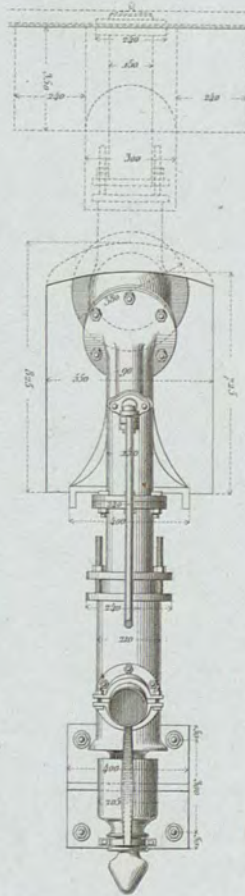
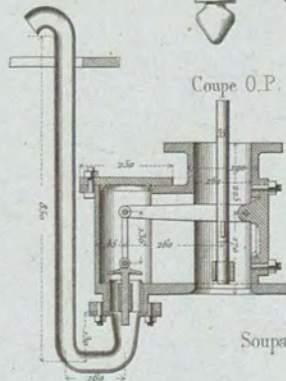
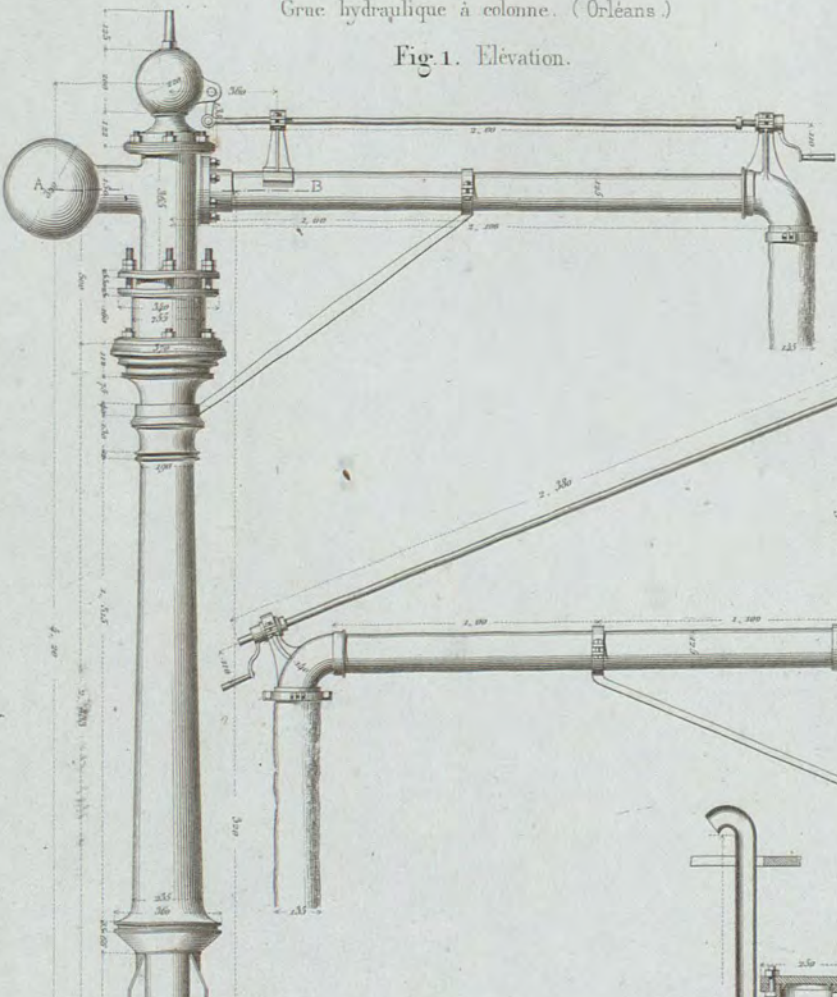

Fig. 5. Vue de face.



Grue hydraulique à colonne. (Orléans)

Fig. 1. Elevation.



Coupe O.P.

Fig. 4.



Profil.

Soupape d'évacuation.

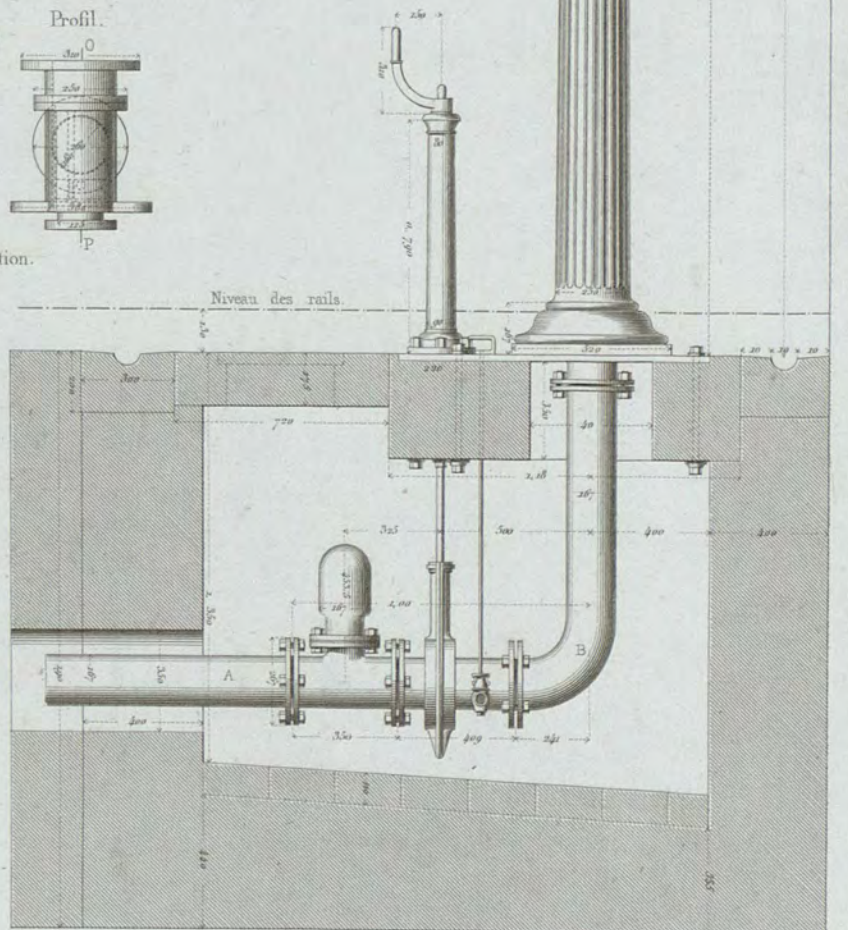
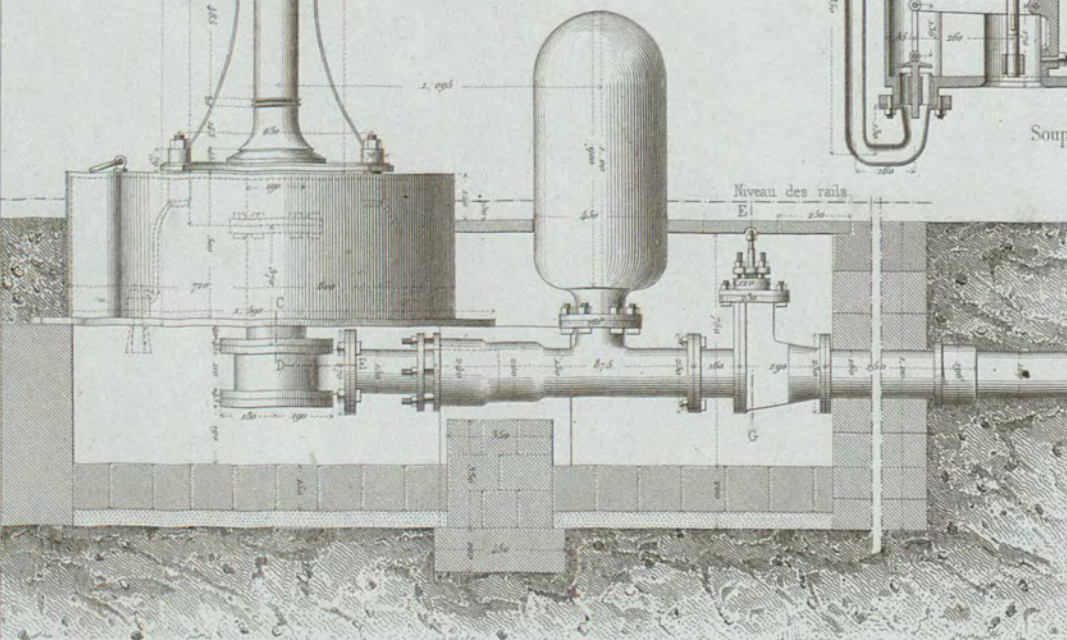

Fig. 3.2 Coupe de la Crapaudine.

Fig. 1.4 Coupe E. G.

Fig. 1. Plan.

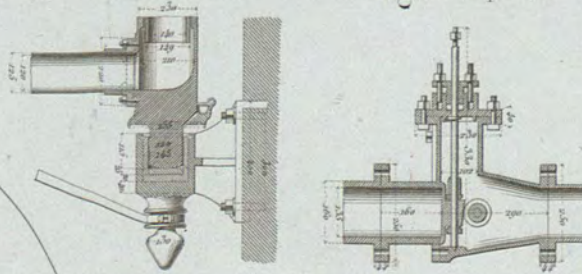
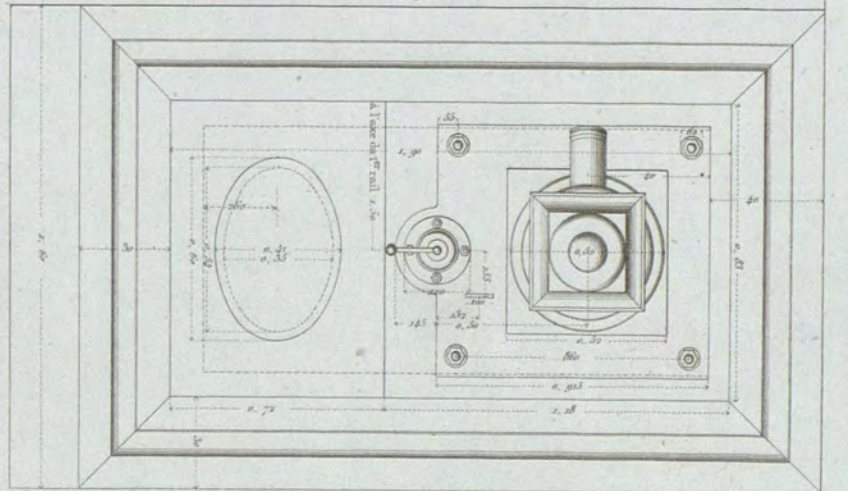

Fig. 2. Plan.



Echelle des ensembles 0,04.

Echelle des détails 0,05.

Fig. 1.

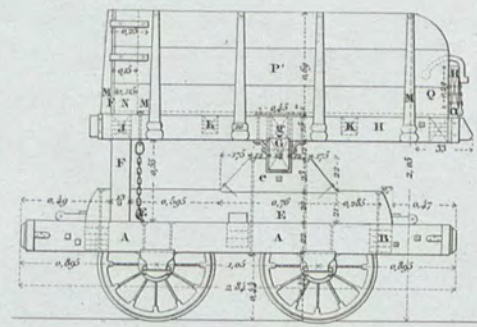

Fig. 2.

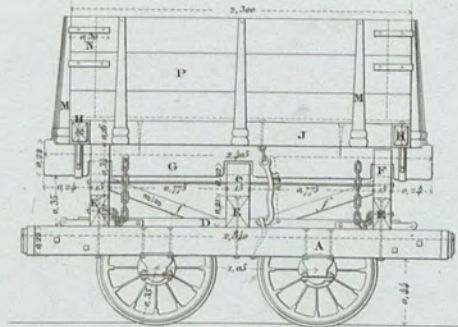

Fig. 3.

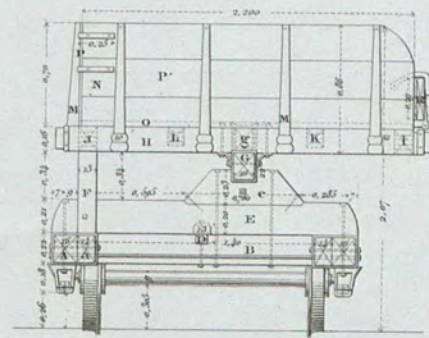

Fig. 4.

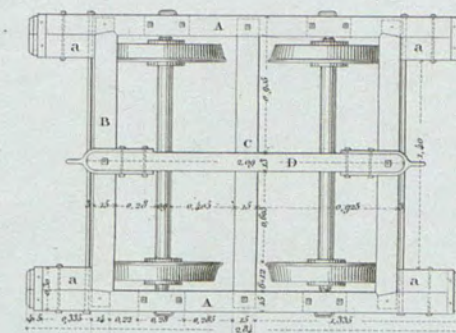

Fig. 5.

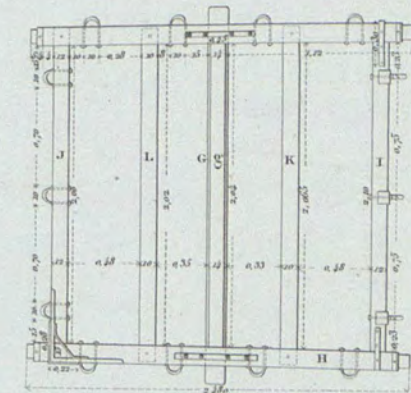

Fig. 6.

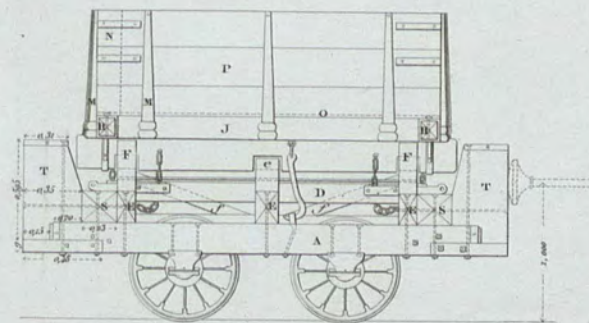

Fig. 7.

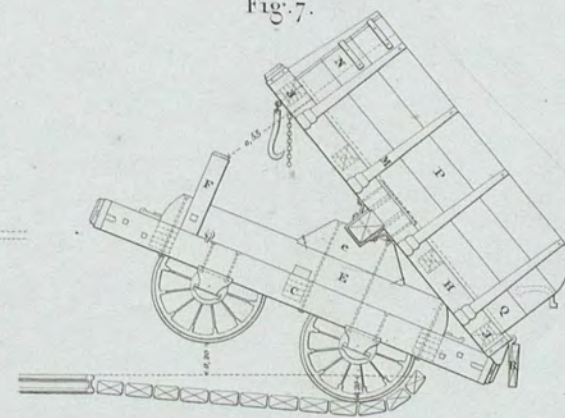

Fig. 9<sup>1</sup>.

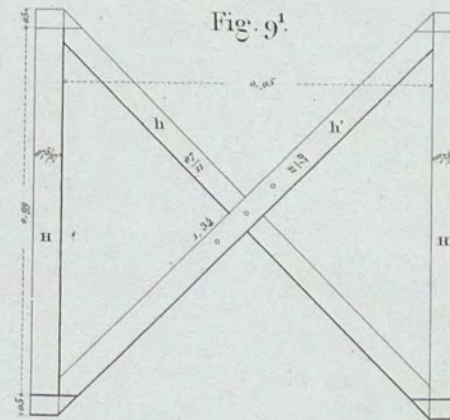

Fig. 11<sup>1</sup>.

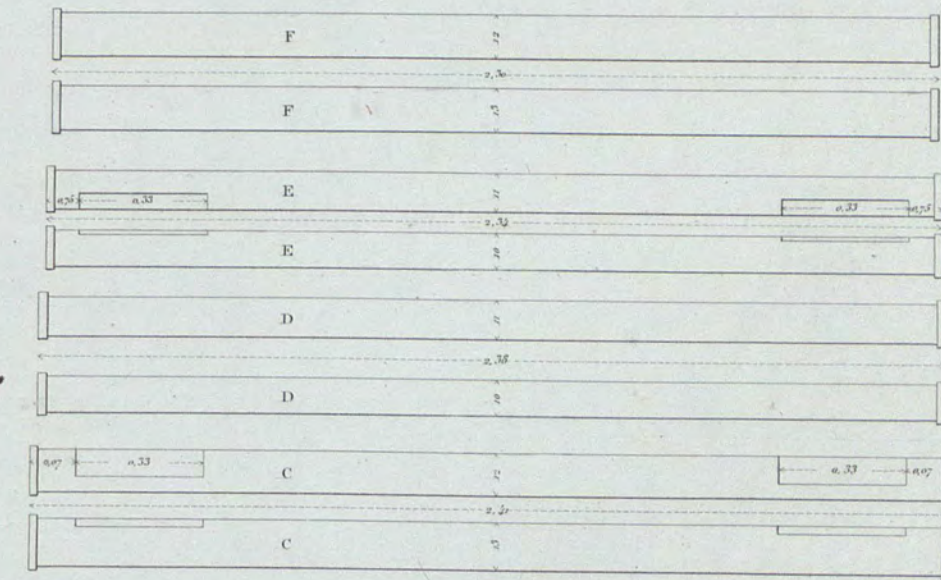

Fig. 8.

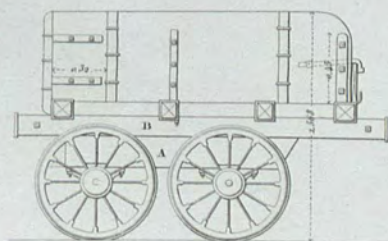

Fig. 10.

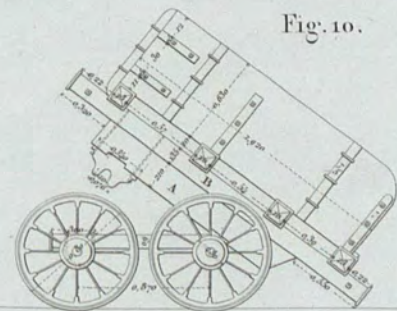

Fig. 12.

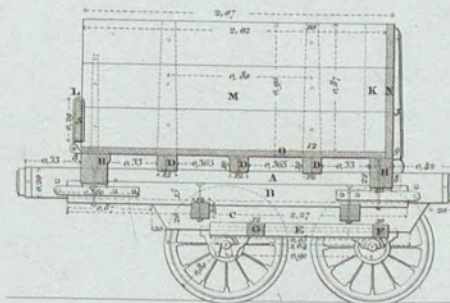

Fig. 10<sup>1</sup>.

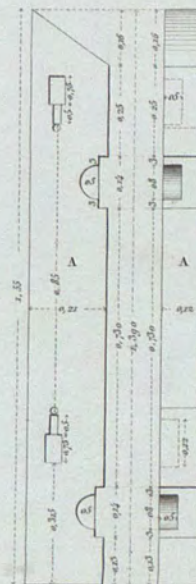

Fig. 11<sup>2</sup>.

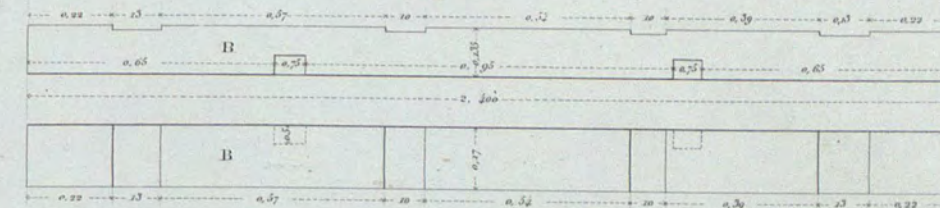

Fig. 9.

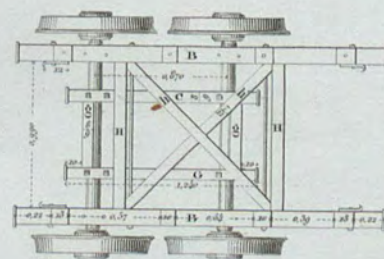

Fig. 11.

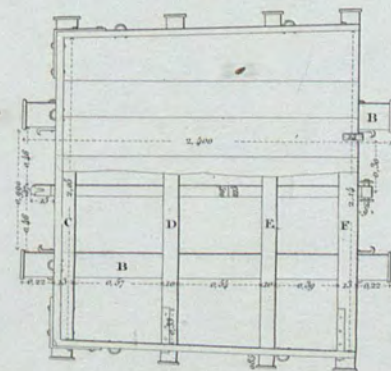
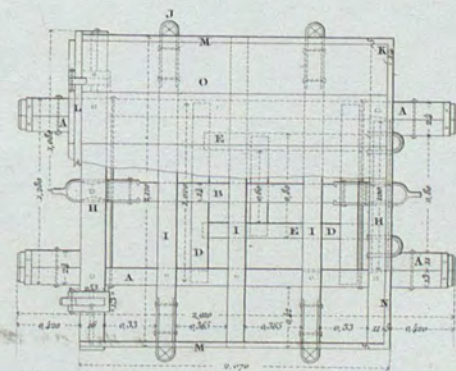
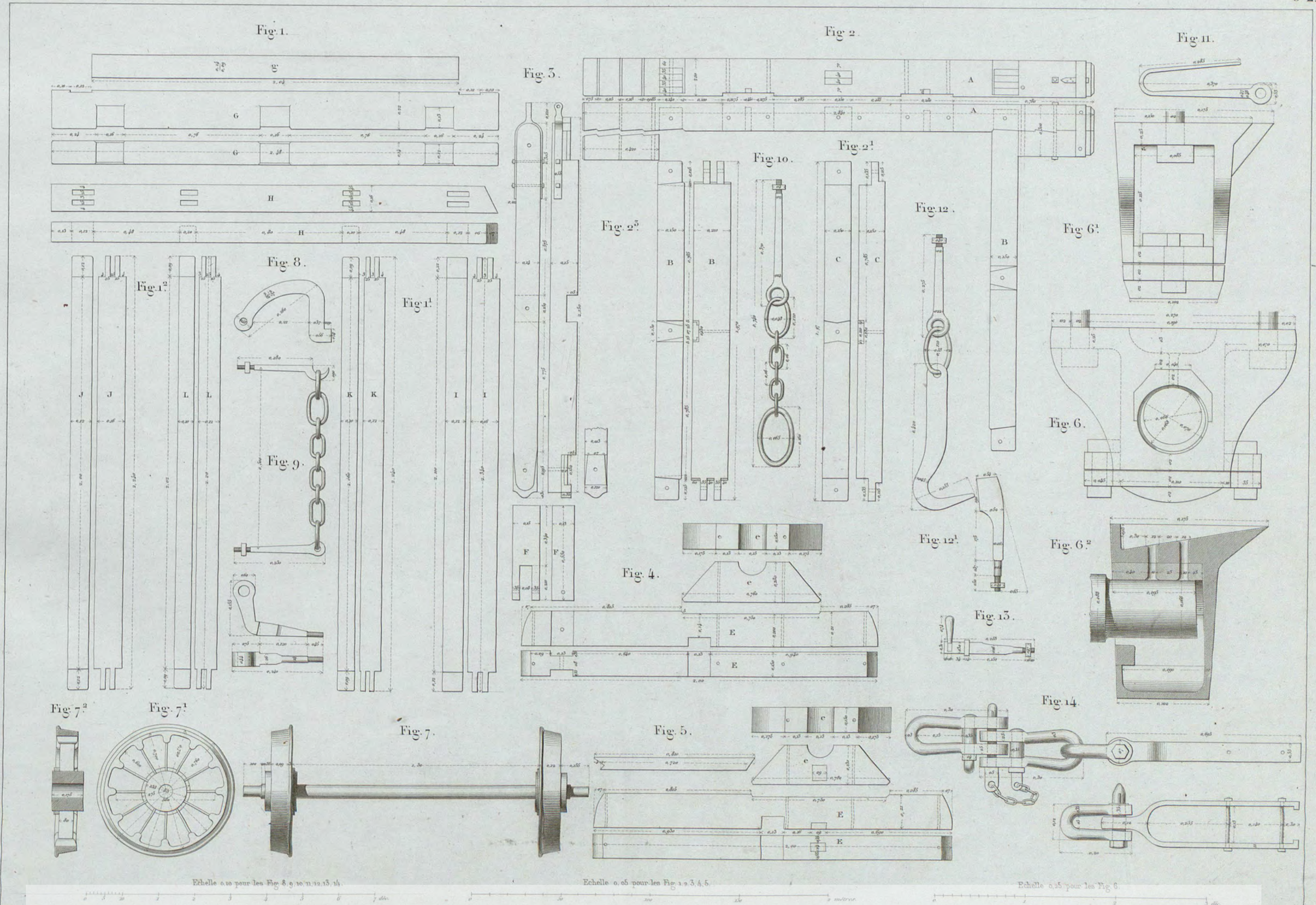

Fig. 15.



Echelle des ensembles 0,02 pour 1 mètre.

Echelle des détails 0,05 pour 1 mètre.



A. Jacquin del.



Fig. 1. Coupe longitudinale AB.

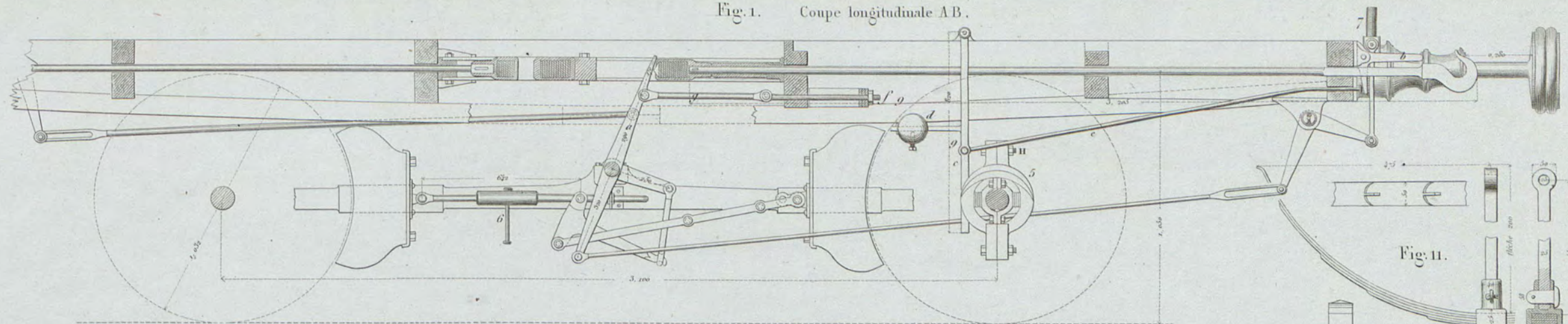

Fig. 2. Plan

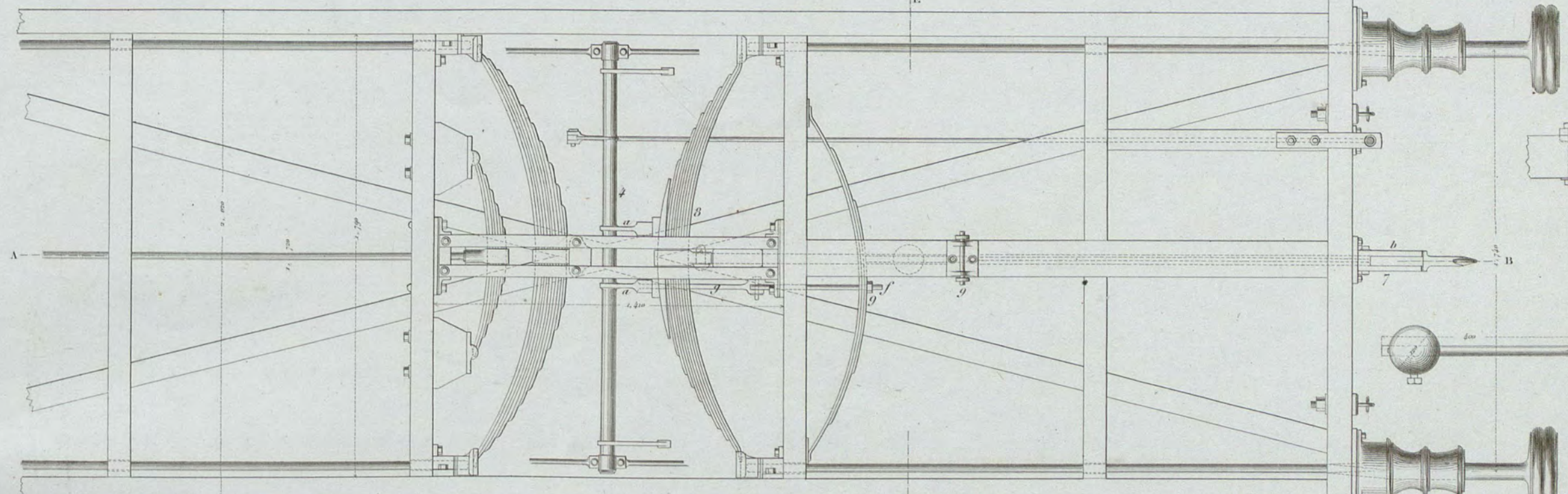

Fig. 4.

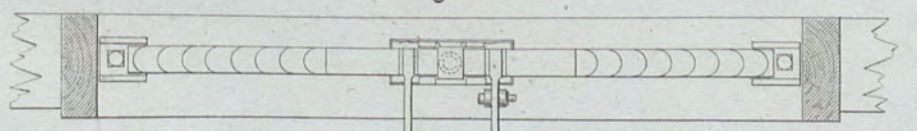

Fig. 5. Coupe transversale EF.

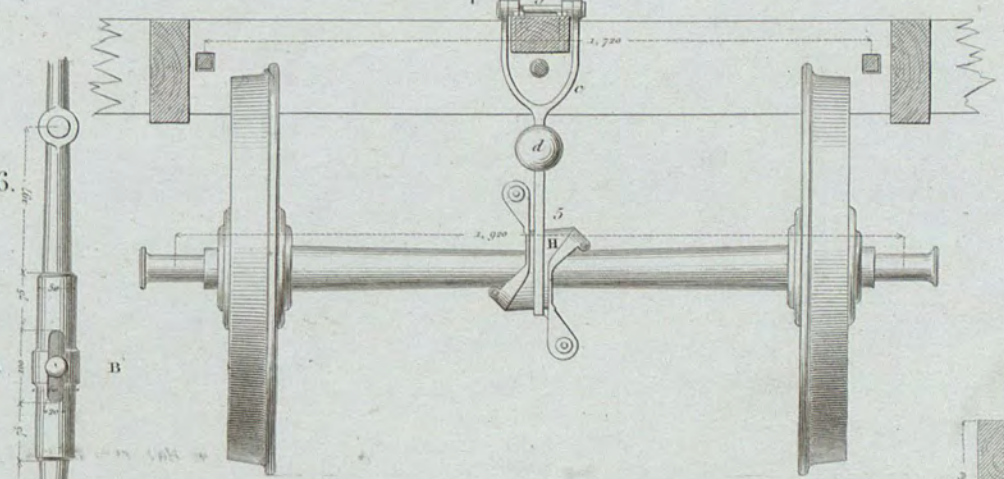
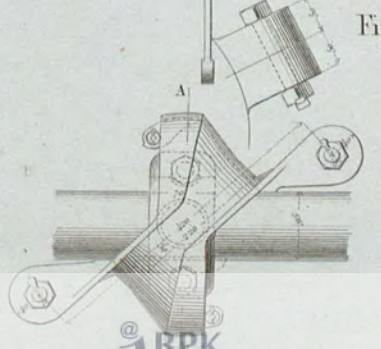

Fig. 5.



Coupe AB.

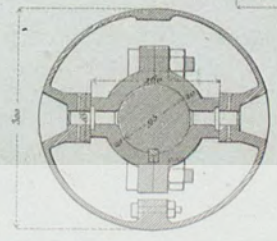

Fig. 6.



Echelle 0,10 pour les Détails

Echelle 0,05 pour la Coupe et le Plan

Fig. 11.

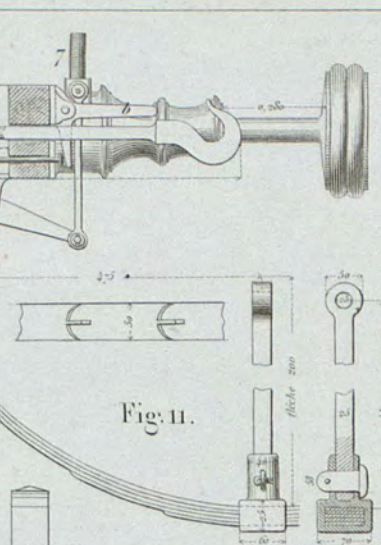

Fig. 10.

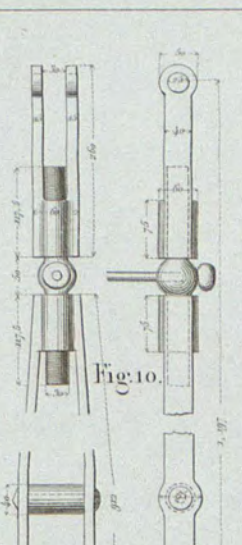

Fig. 9.

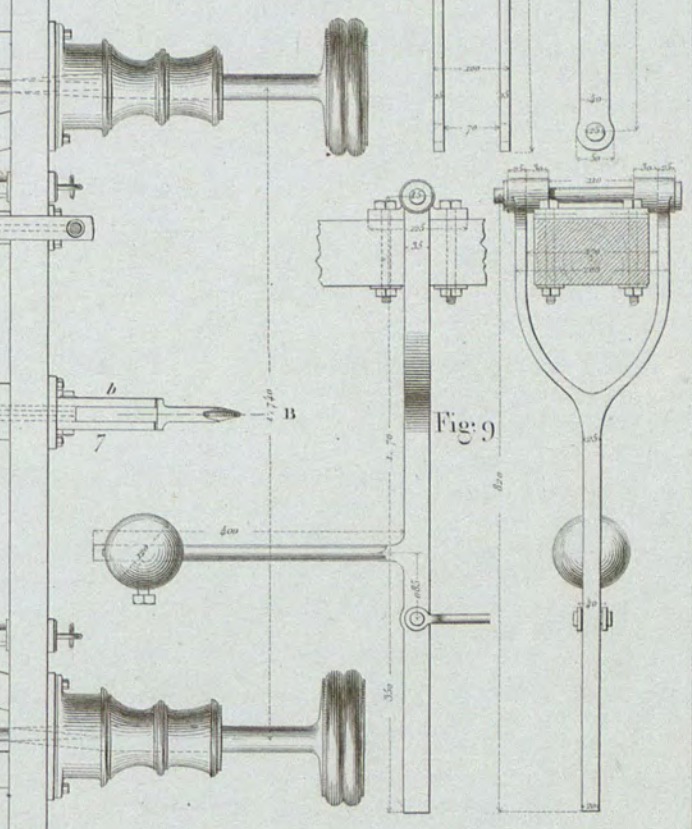

Fig. 8.

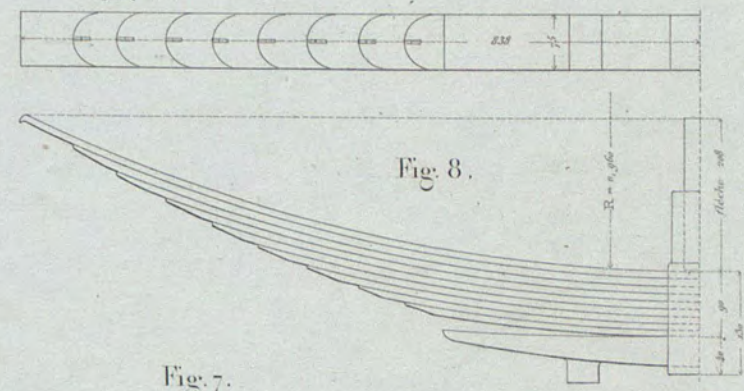
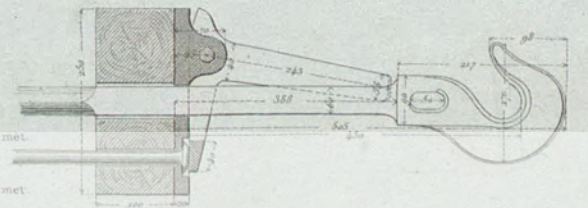
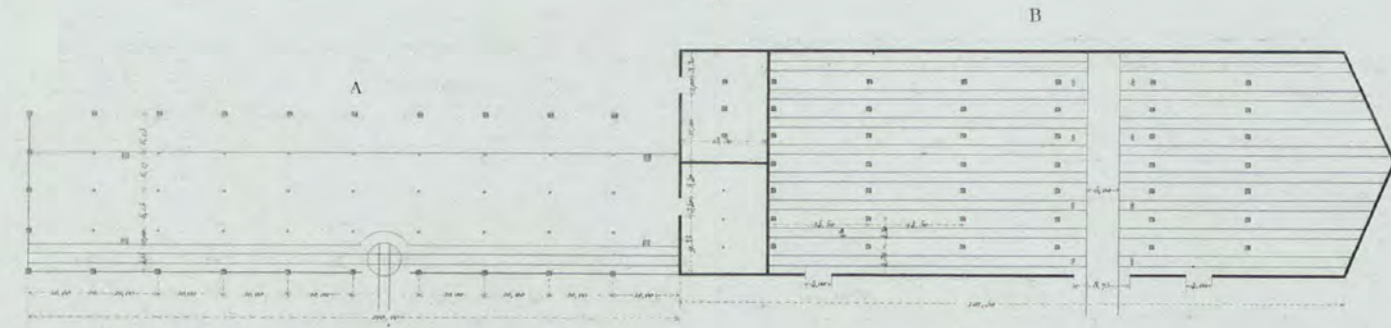

Fig. 7.



PLAN DE LA HALLE A MARCHANDISE A ET D'UNE REMISE POUR VOITURES B.

Fig 2.



Echelle du Plan général 0<sup>m</sup>000 pour 1 Mètre

Fig 1.

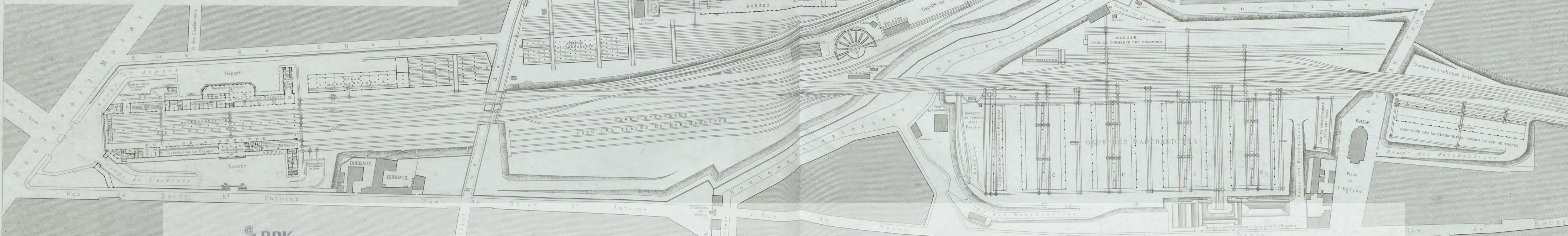

PLAN DES HALLES A MARCHANDISE C ET D

Fig 3.

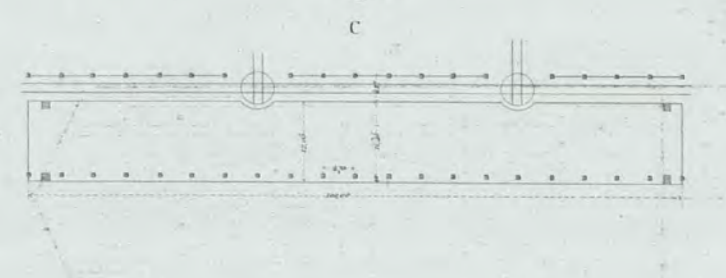

Echelle des Plans de Halles à Marchandises 0<sup>m</sup>000 pour 1 Mètre

Fig 4.

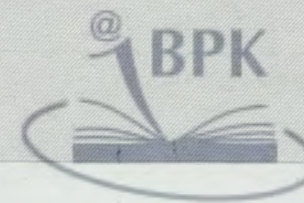
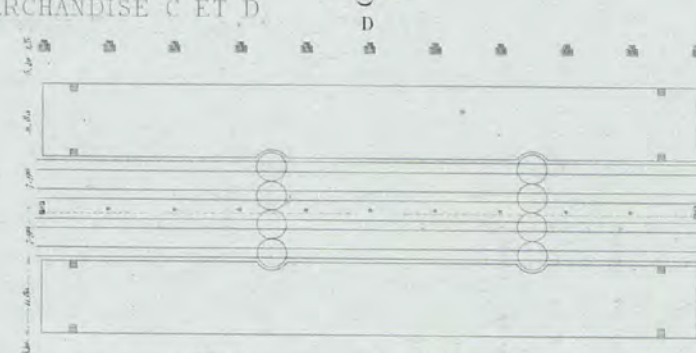

BIBLIOTEKA CYFROWA POLITECHNIKI KRAKOWSKIEJ



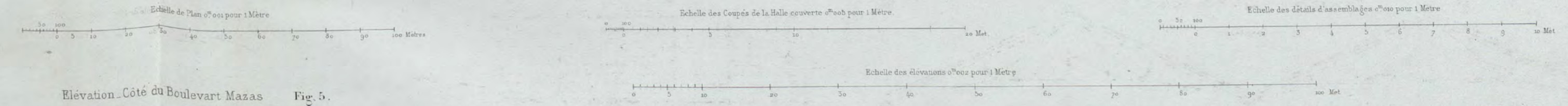
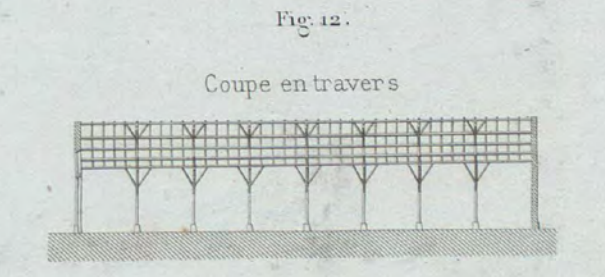
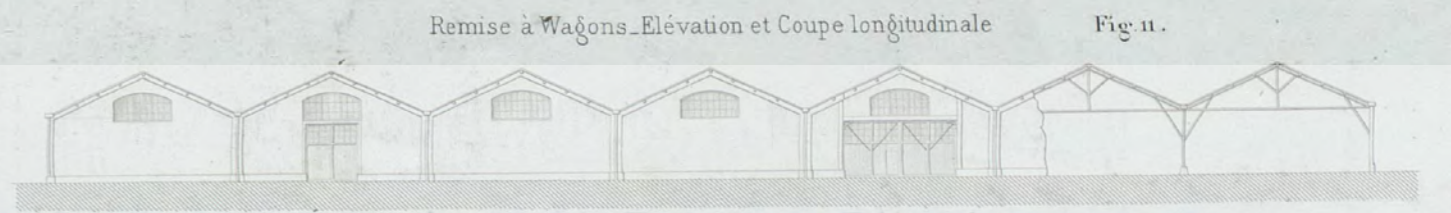
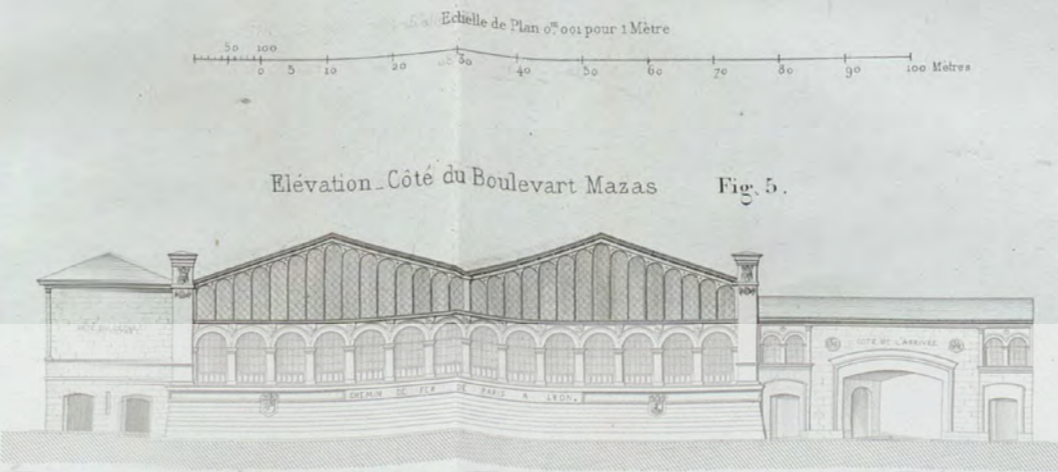
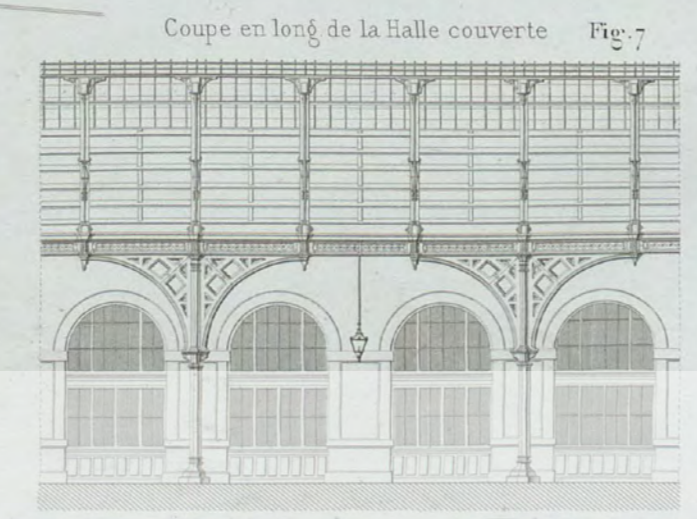
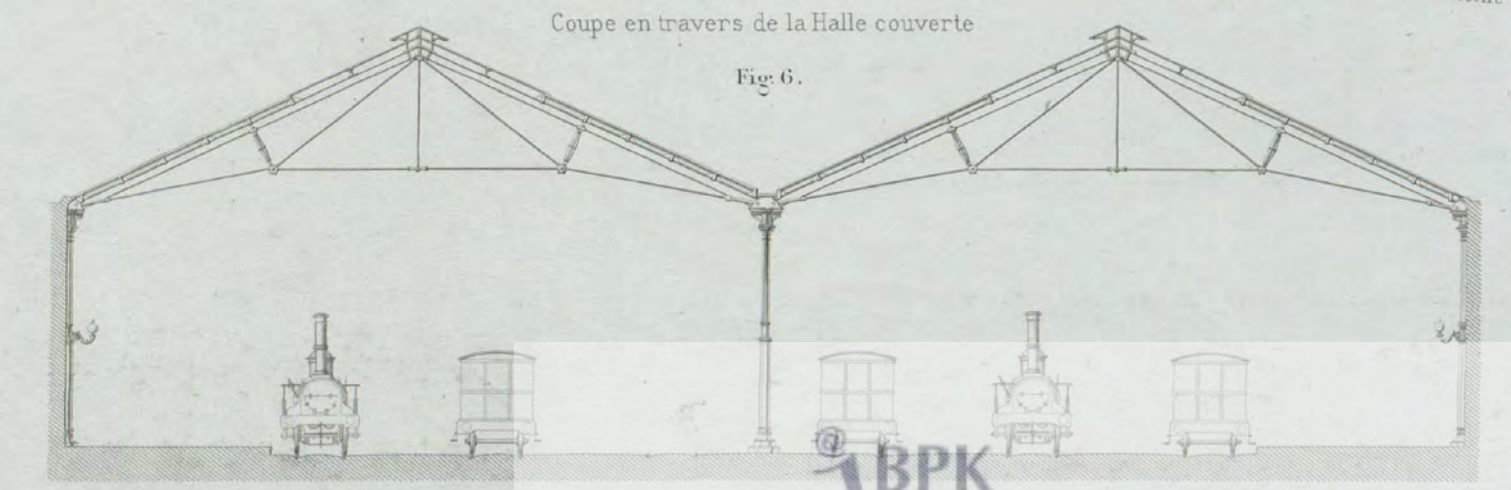
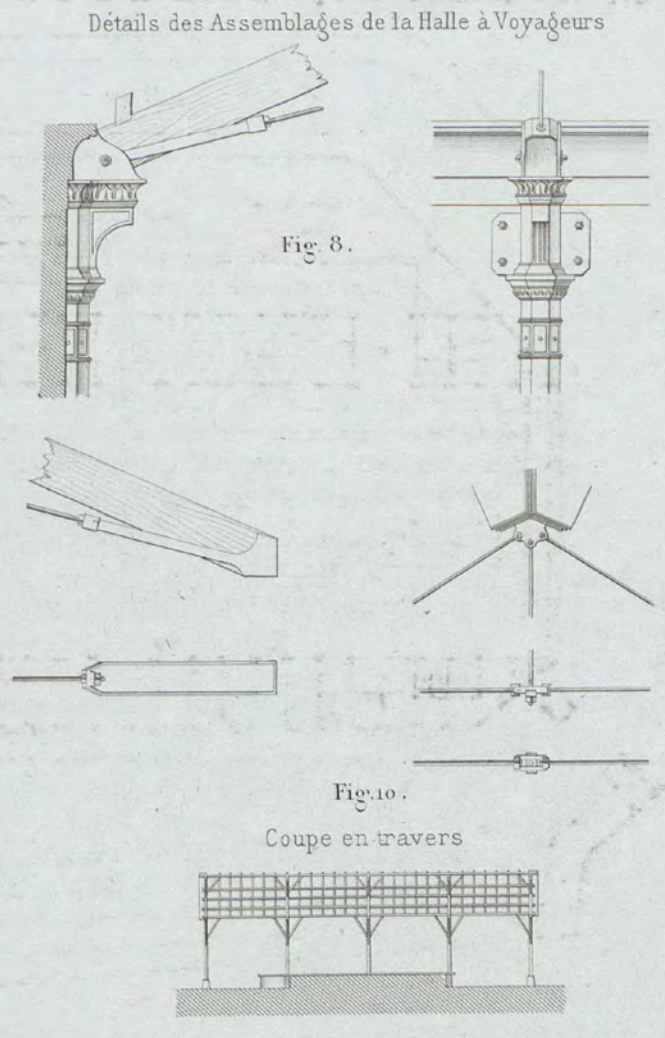
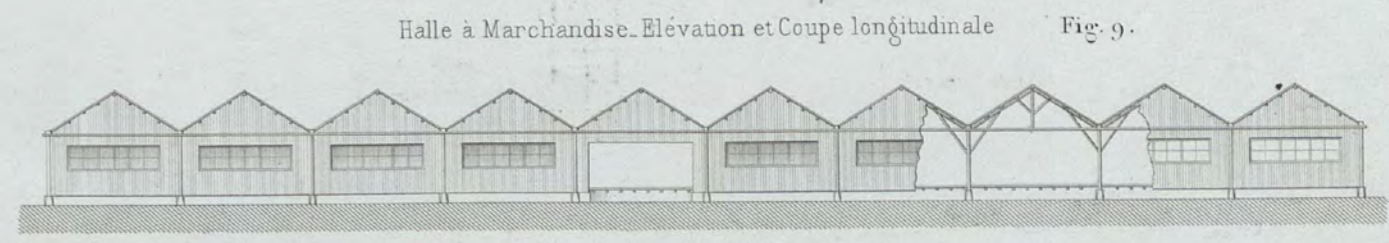
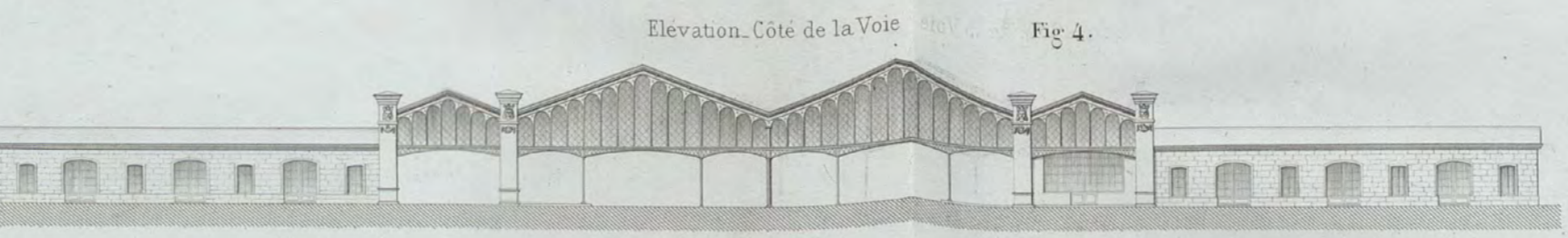
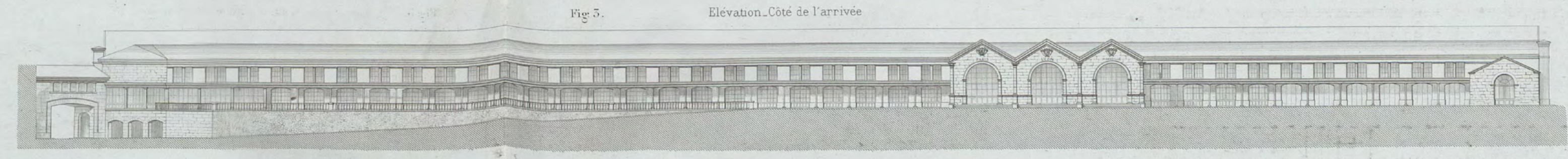
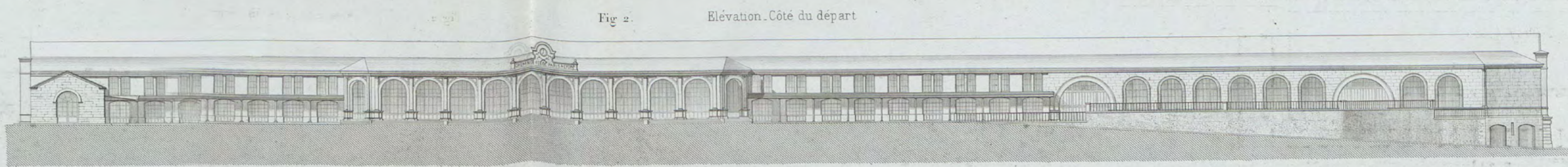
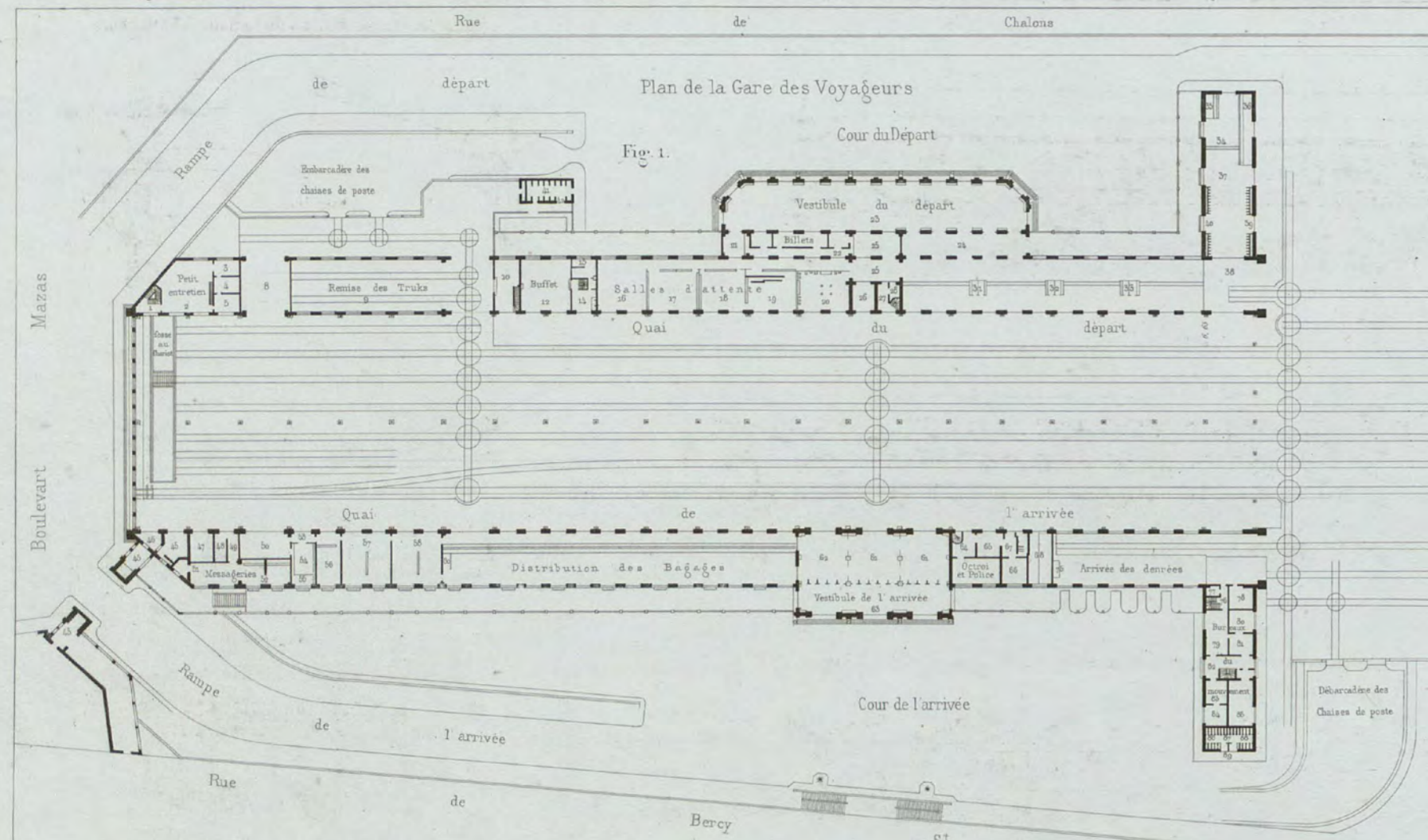

BIBLIOTEKA CYFROWA POLITECHNIKI KRAKOWSKIEJ





Echelle de 0<sup>m</sup>01 pour Mètre

A. Jacquin dir.

Imp. F. Gauthier, rue de Valenciennes, Paris

L. Guéret del. et Sc.



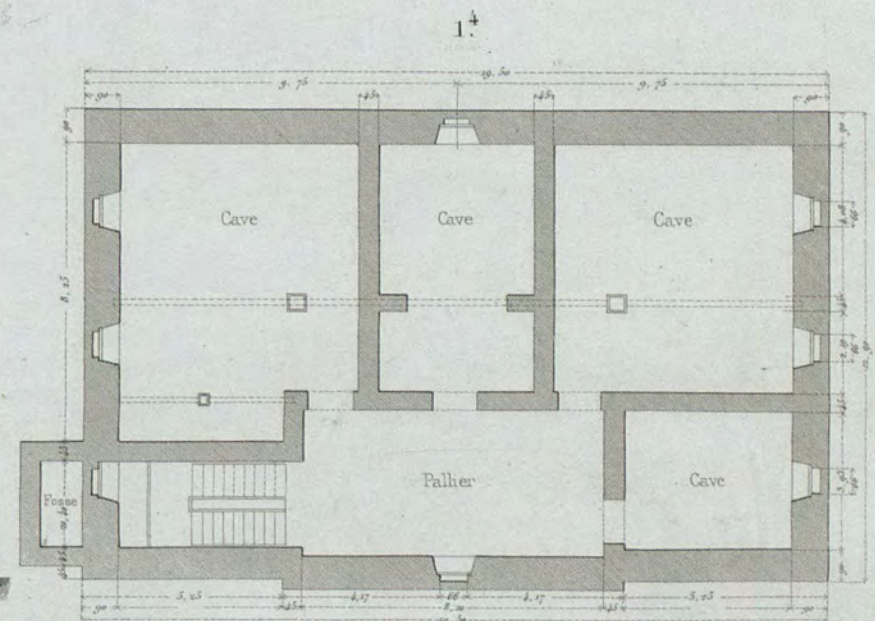
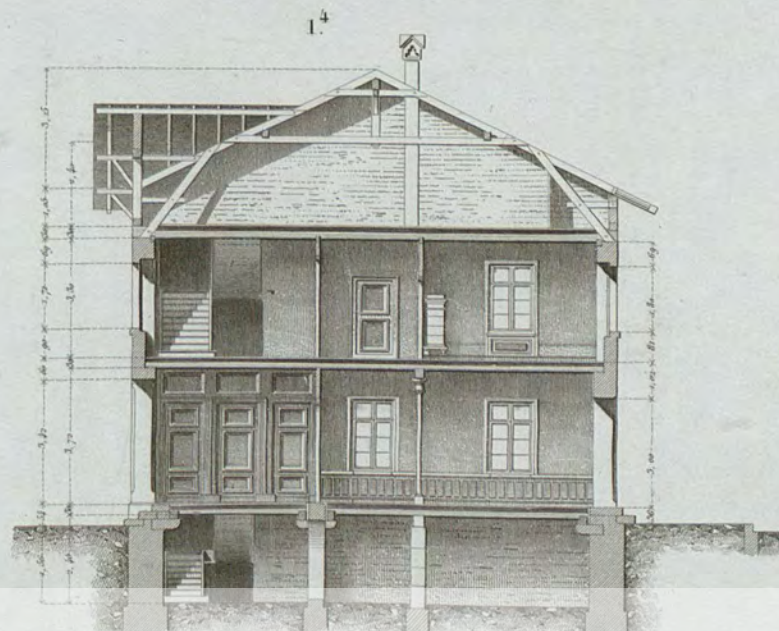
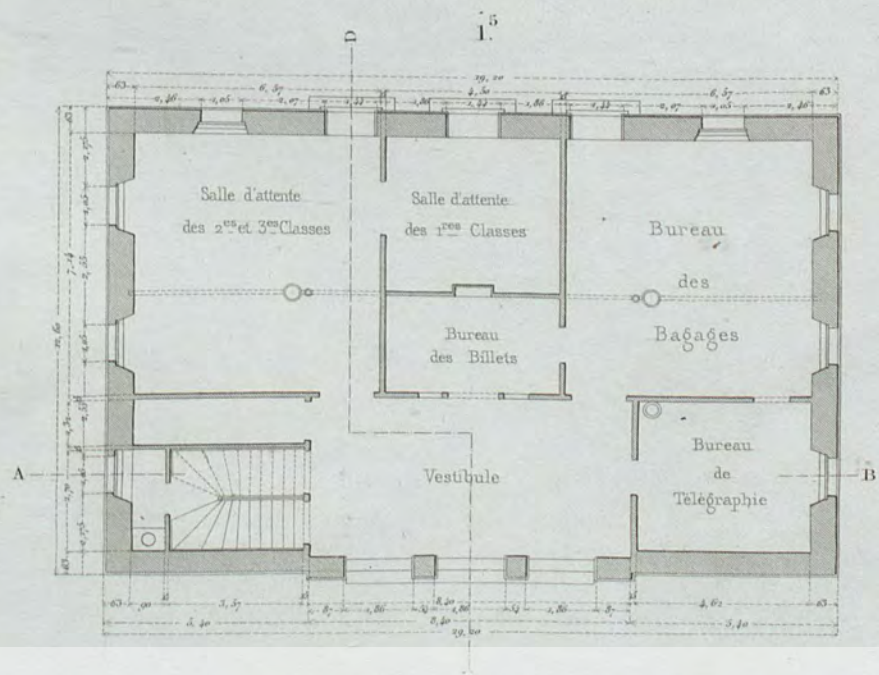
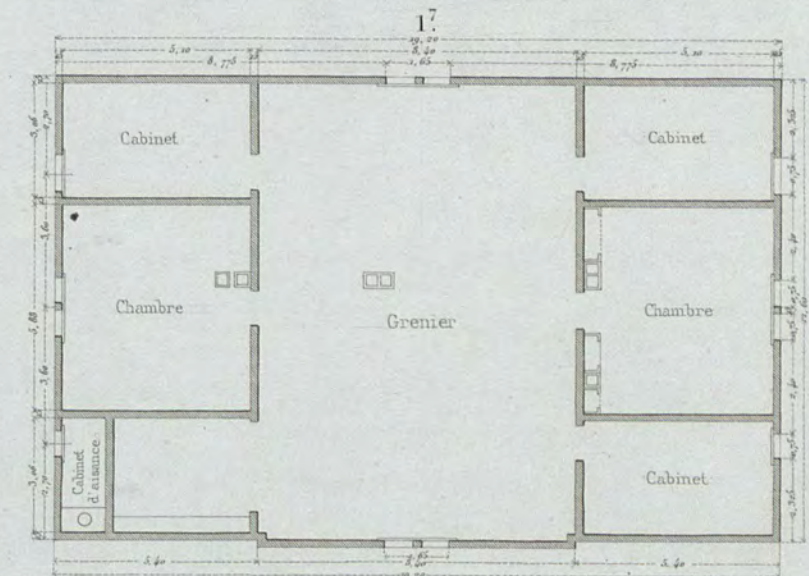
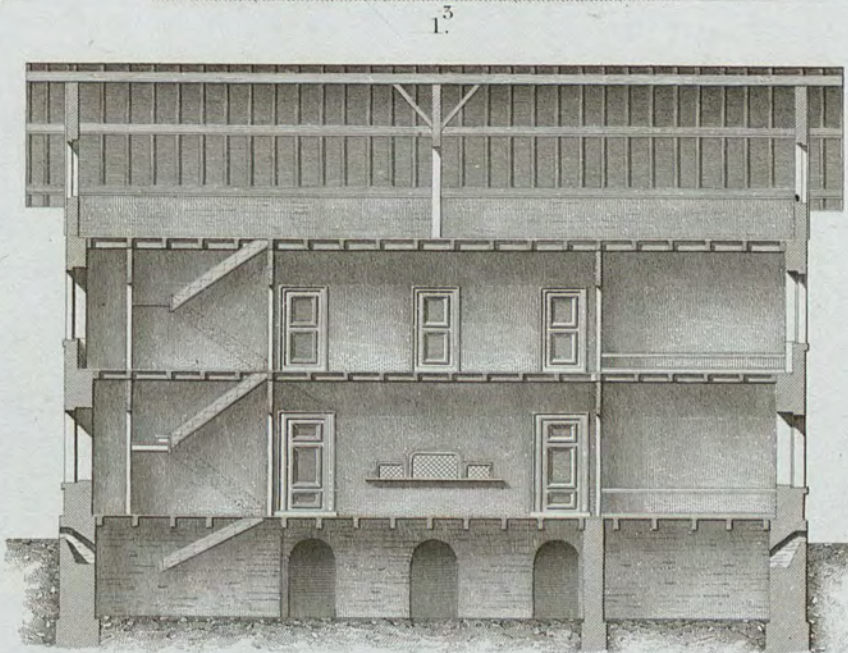
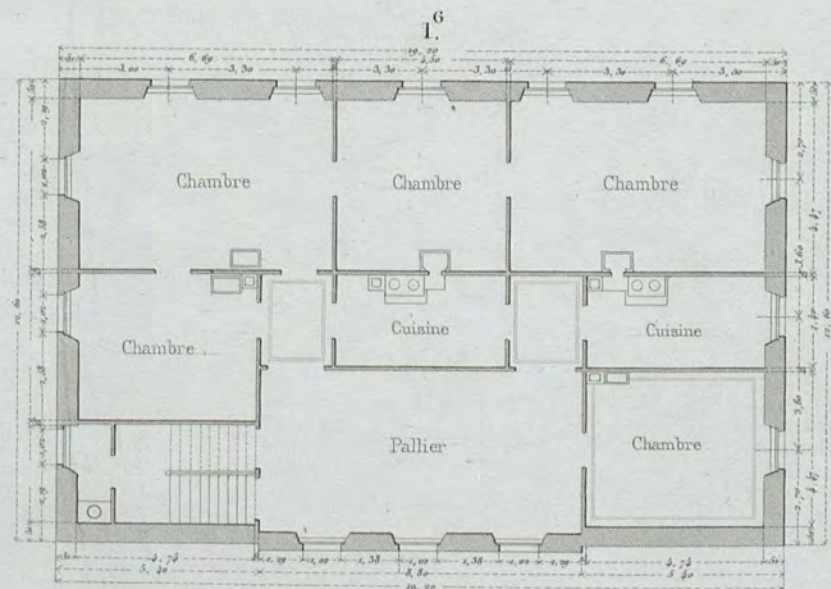
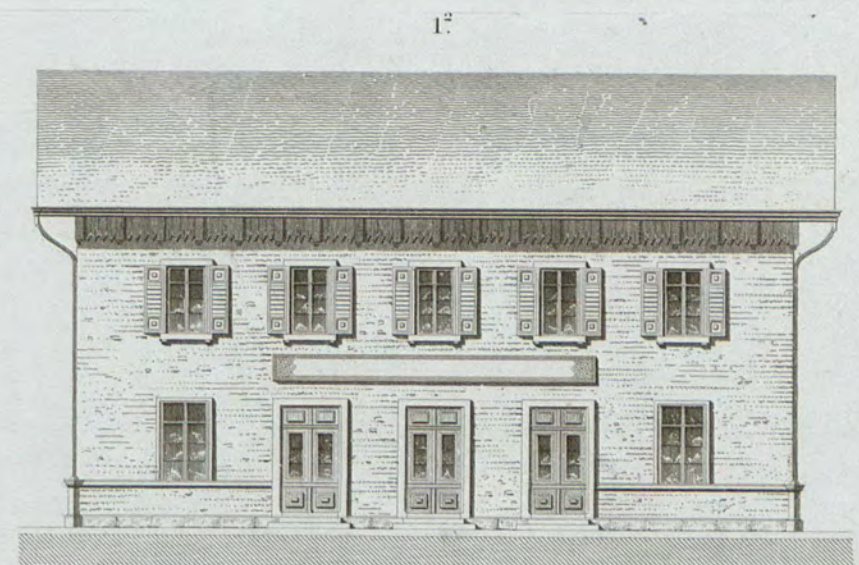
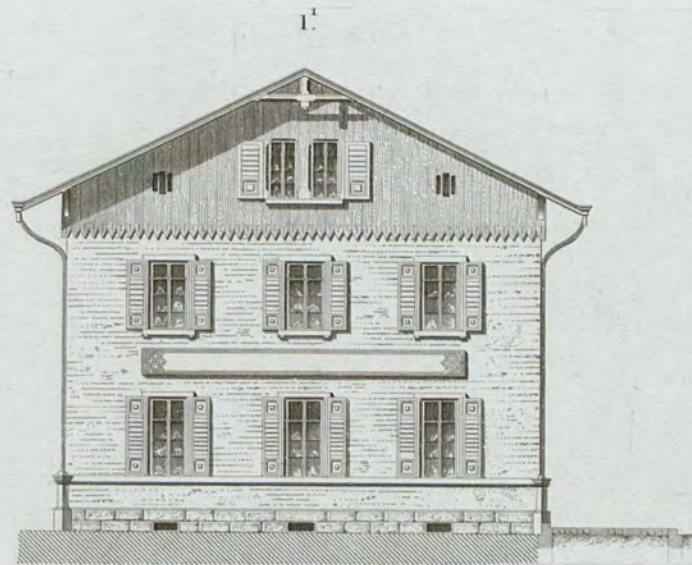
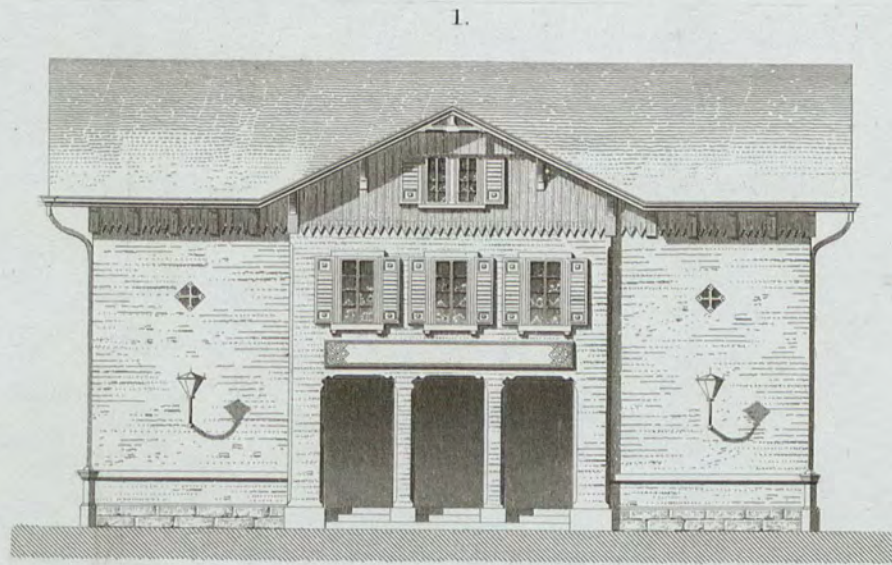

Echelle 0<sup>m</sup> et pour met.

Fig. 1.

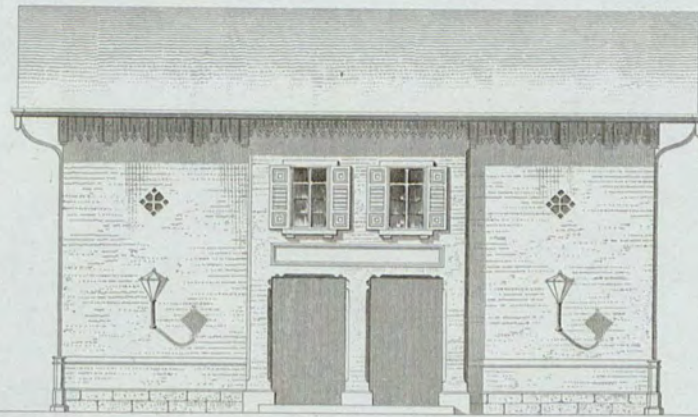

Fig. 3.

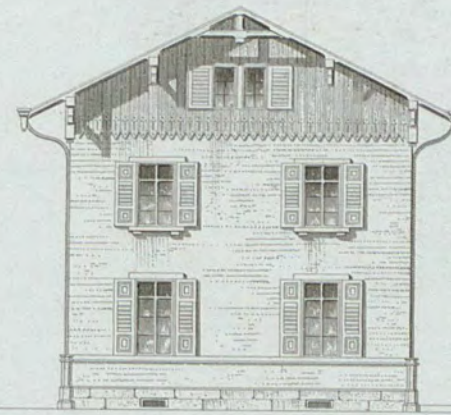

Fig. 2.

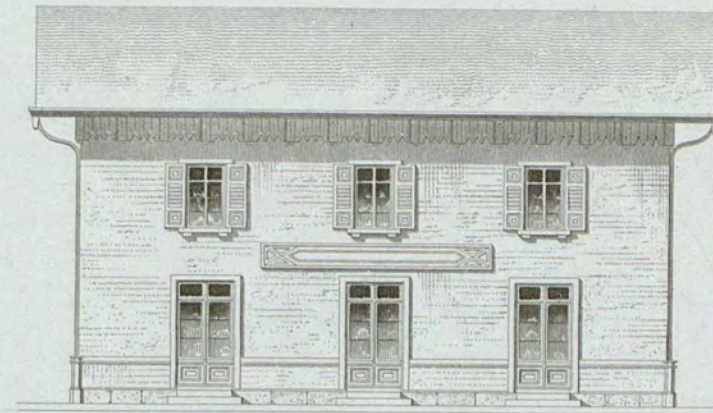

Fig. 4.

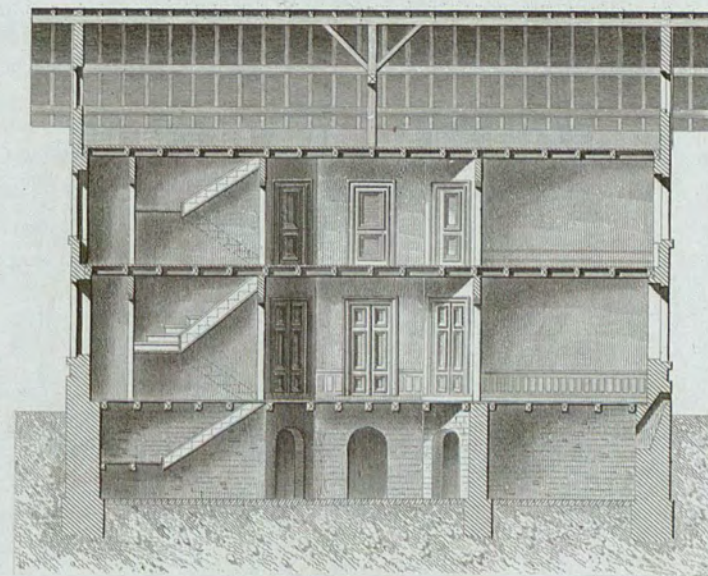

Fig. 9.

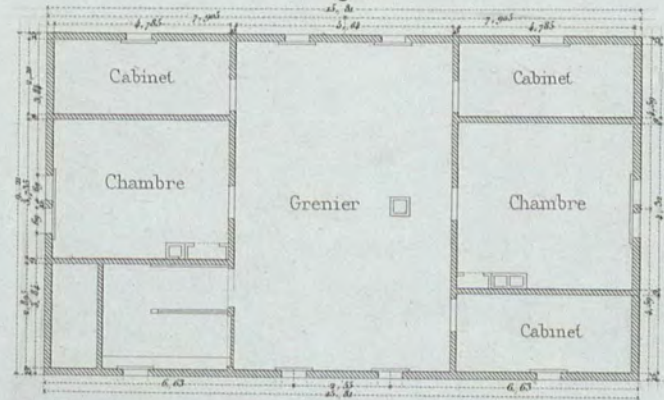

Fig. 8.

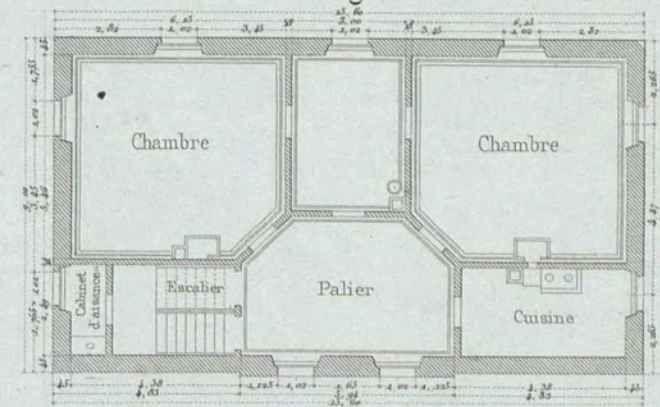

Fig. 5.

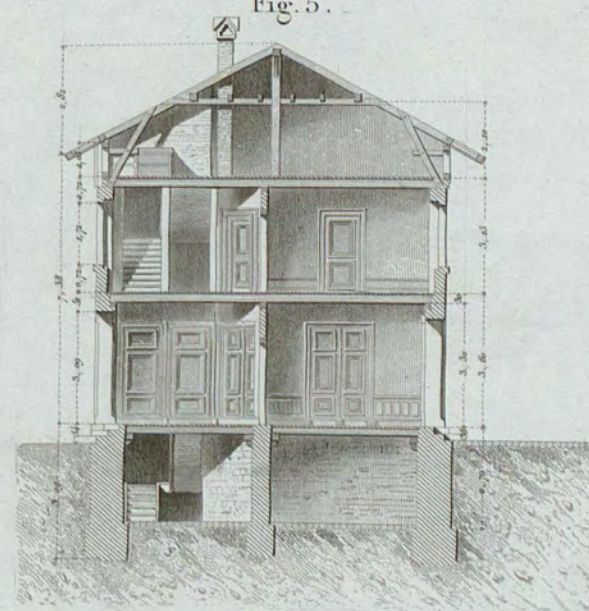

Fig. 7.

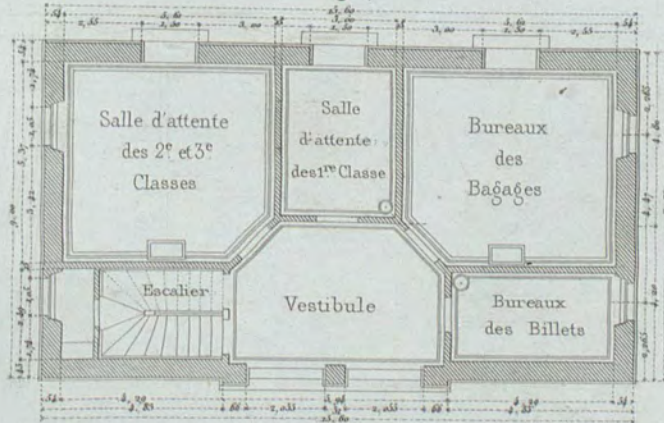
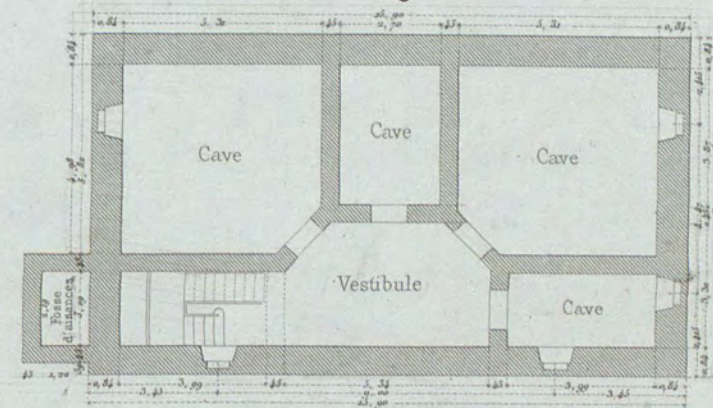
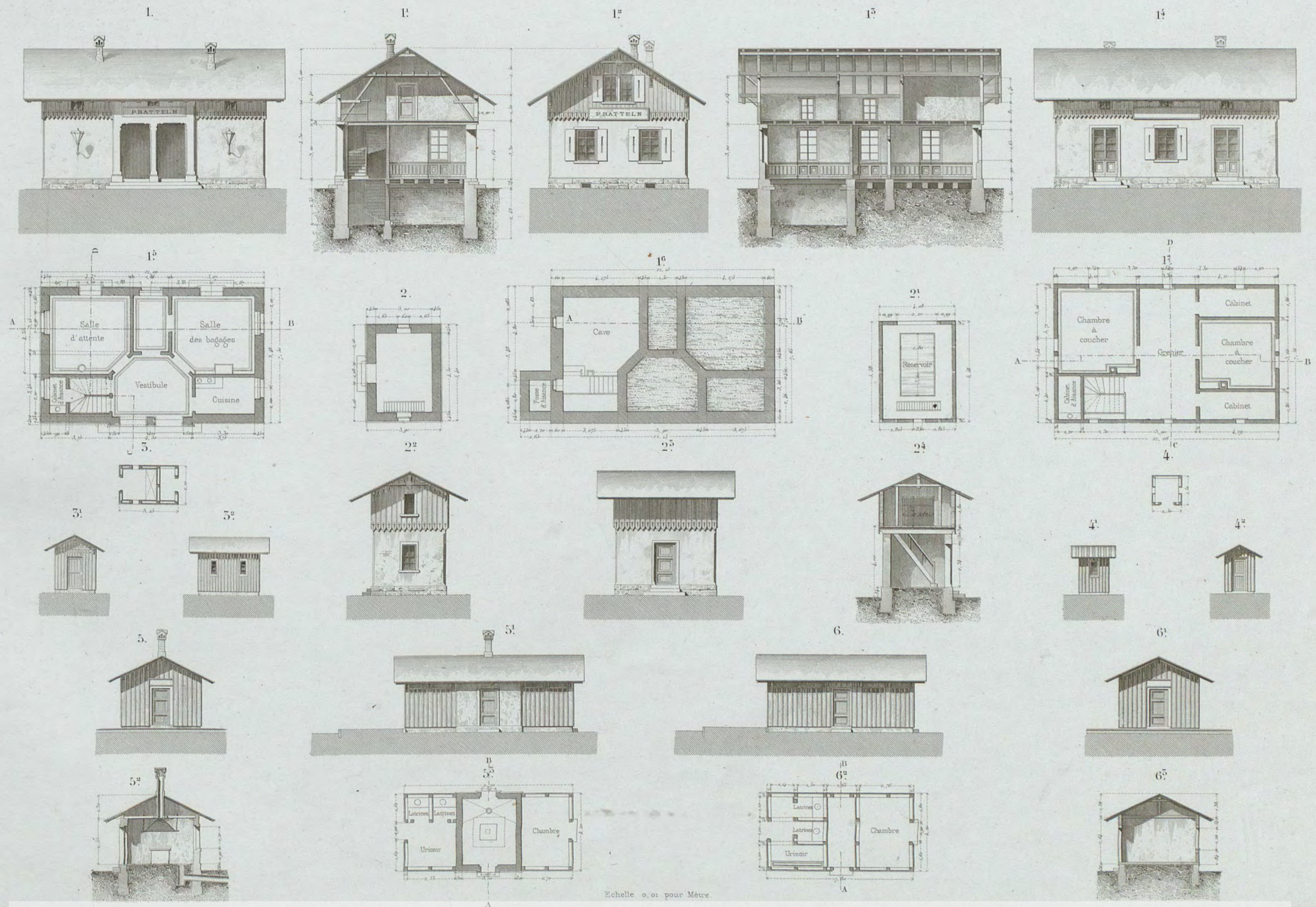

Fig. 6.



Echelle de 0,10 pour mètre.



Echelle 0,01 pour Mètre.

A Jacquin direc<sup>r</sup>



BIBLIOTEKA CYFROWA POLITECHNIKI KRAKOWSKIEJ

L. Guisquet del. et sculp.

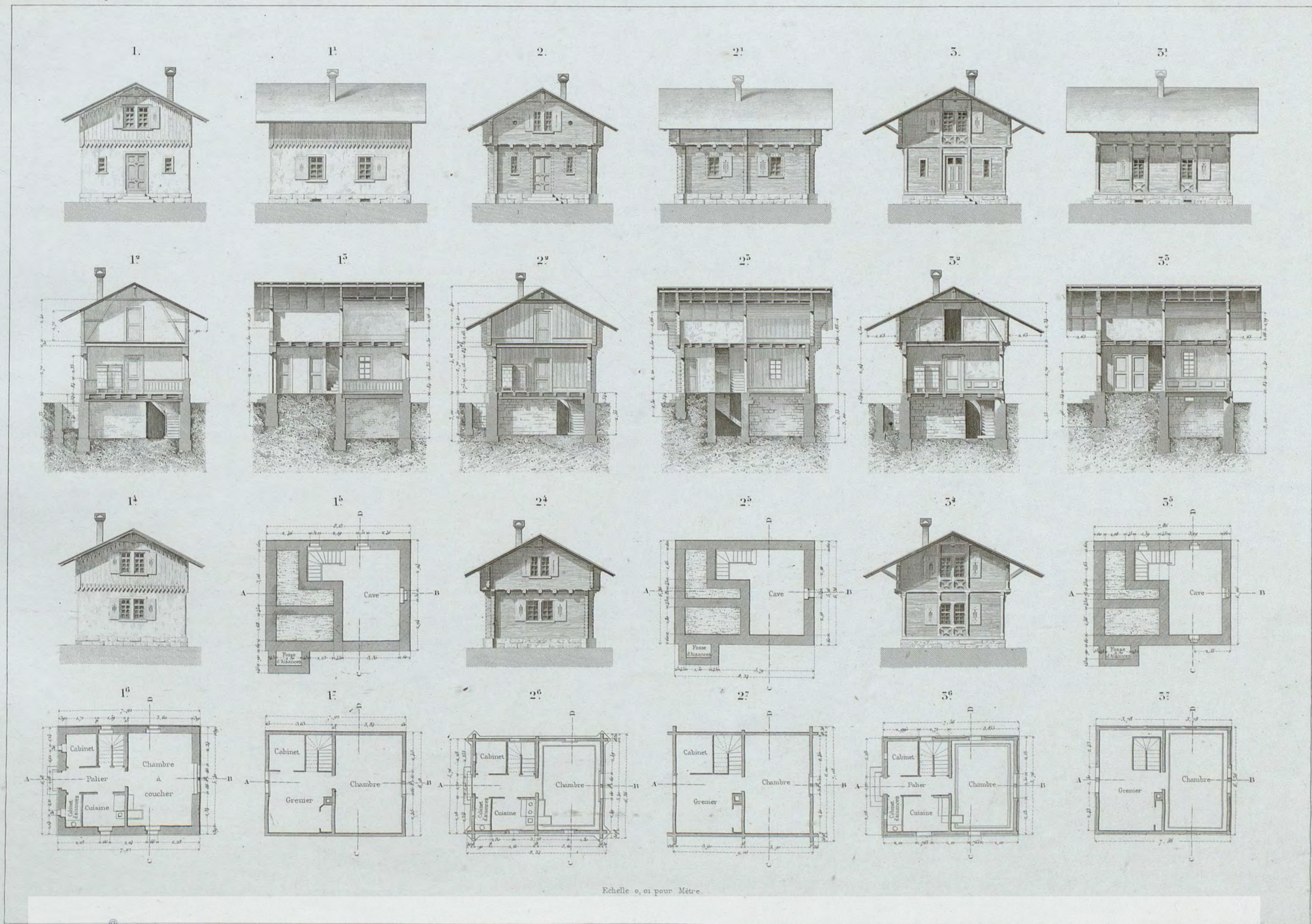

A. Jacquin direct<sup>r</sup>

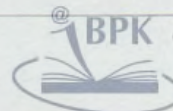

L. Guignot del. et sculp.

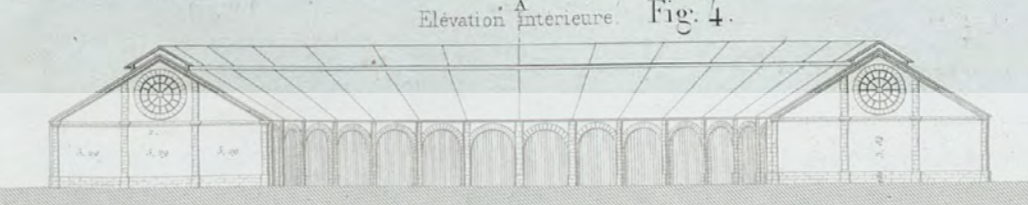
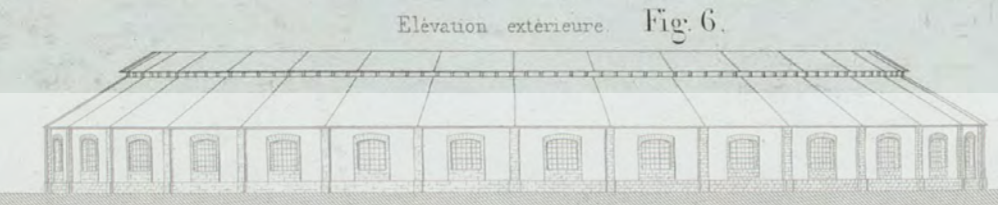
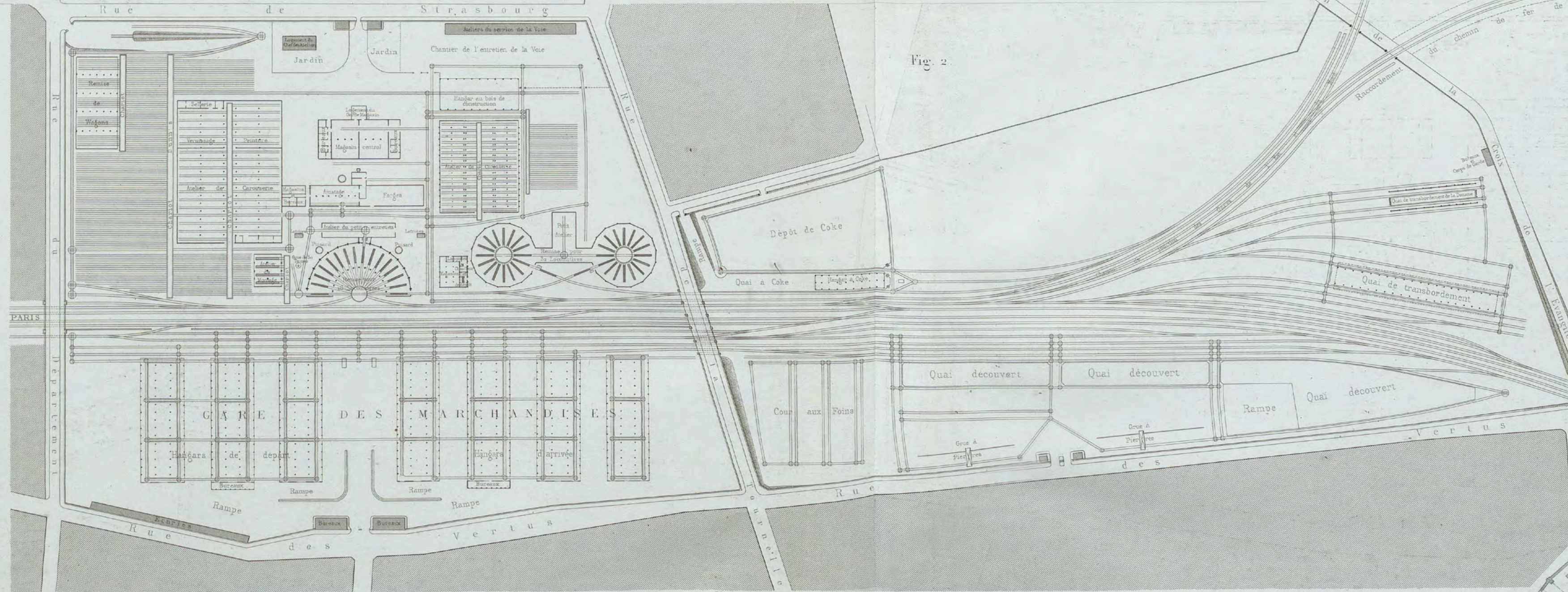
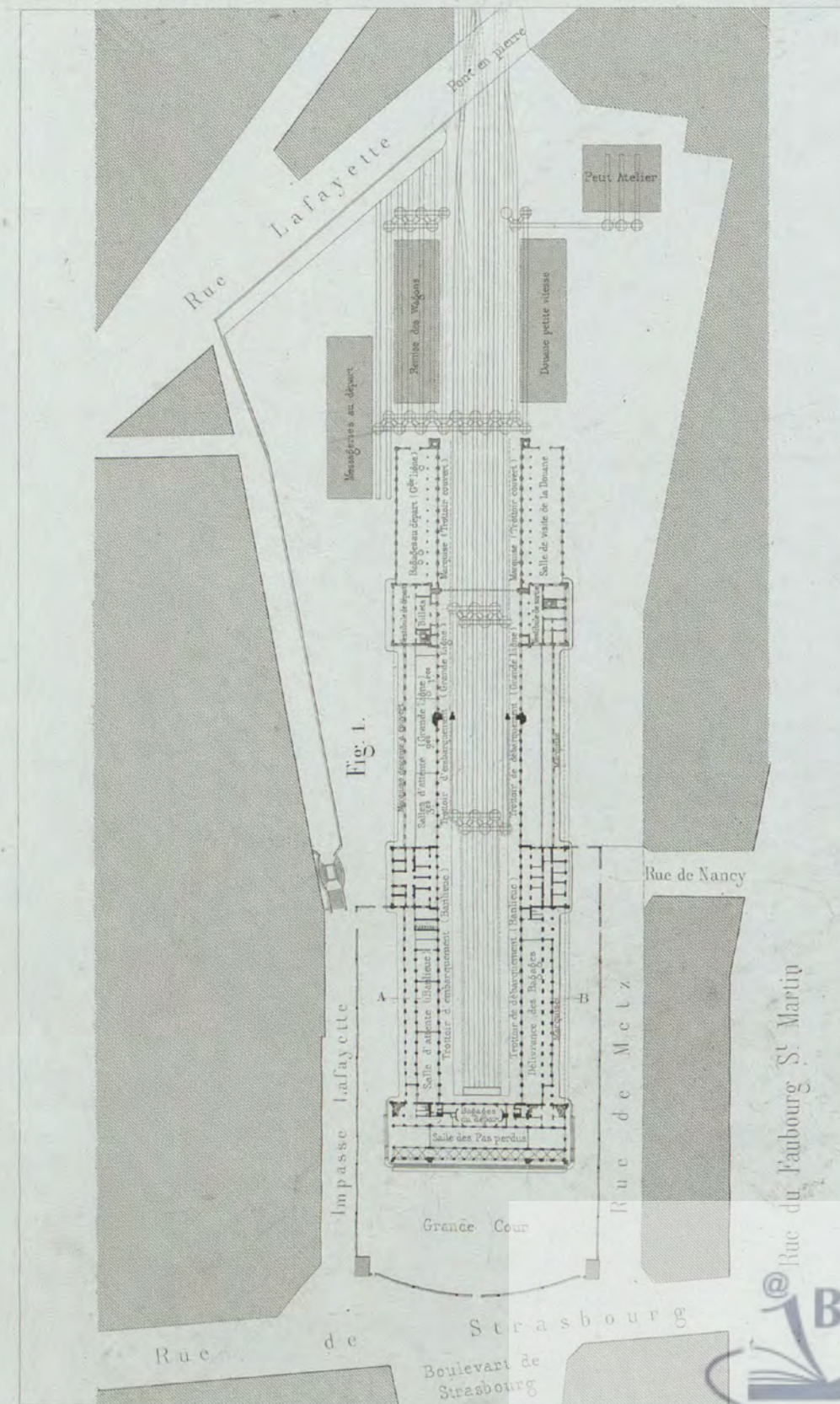

BIBLIOTEKA CYFROWA POLITECHNIKI KRAKOWSKIEJ



Fig. 1. Elevation de la Façade principale.

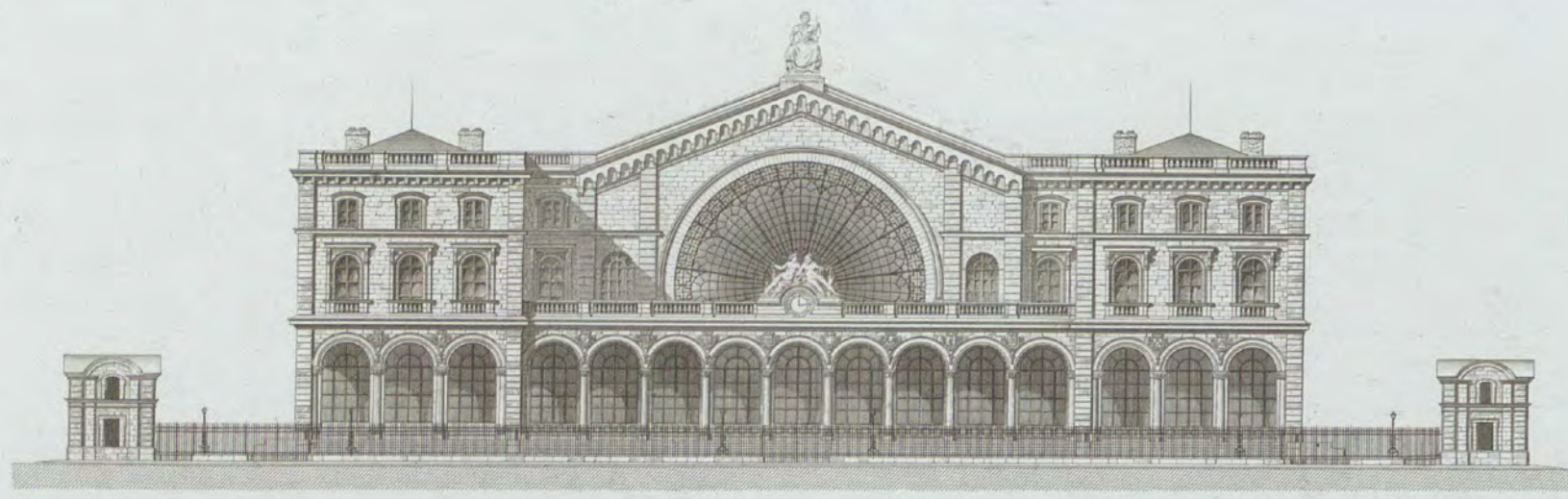

Fig. 2. Elevation — Côte des voies (Etat actuel).

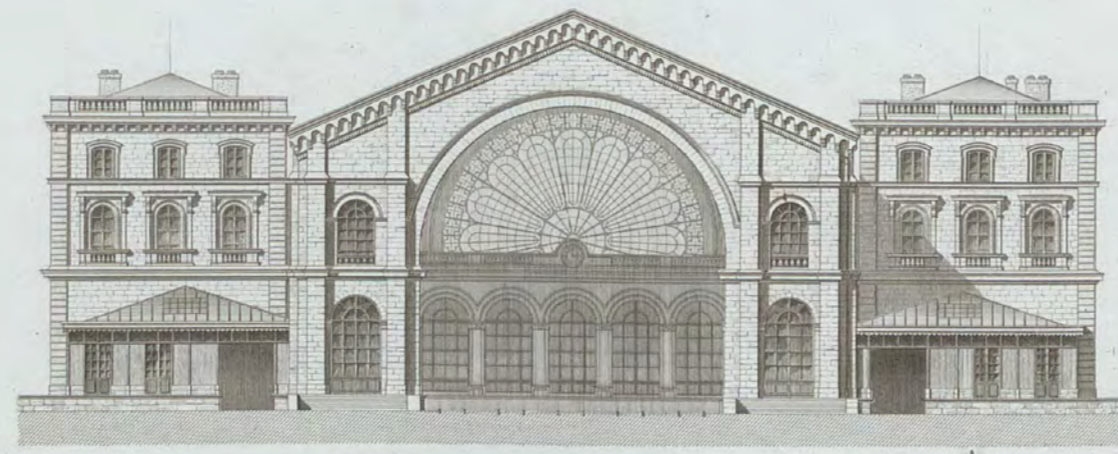

Fig. 5. Coupe en travers (Etat actuel).

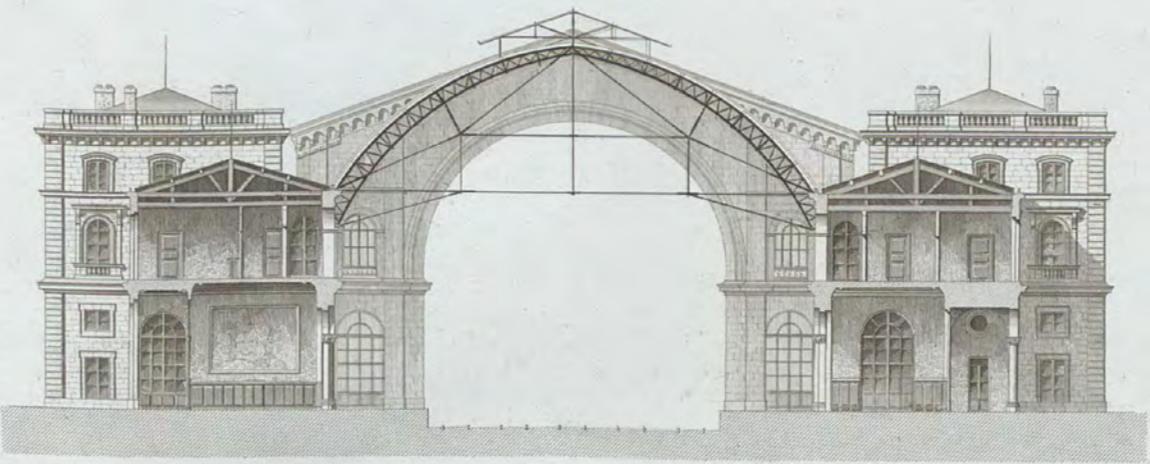

Fig. 4. Elevation projetée (côte des voies).

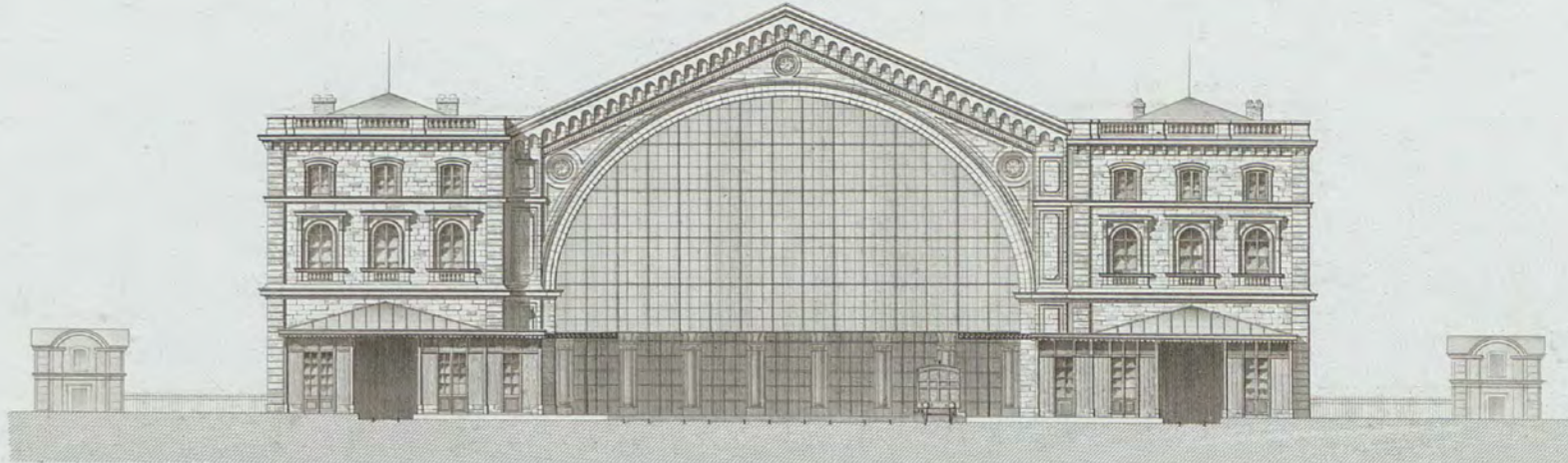
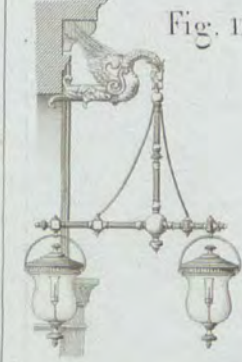

Fig. 11.



Eclairage intérieur de la Gare.

Fig. 7. Elevation de l'Horloge et de son couronnement.

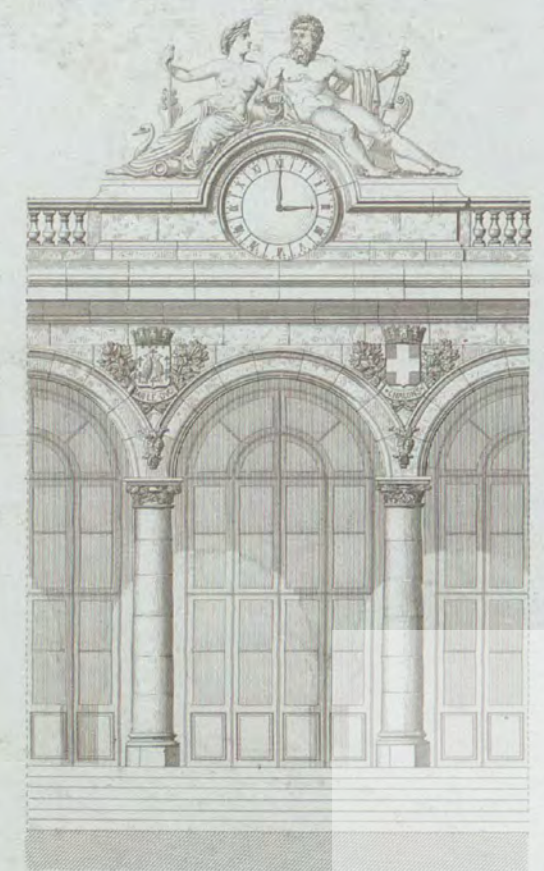

Fig. 12. Armes de Strasbourg.



Fig. 5. Coupe longitudinale (Etat actuel)

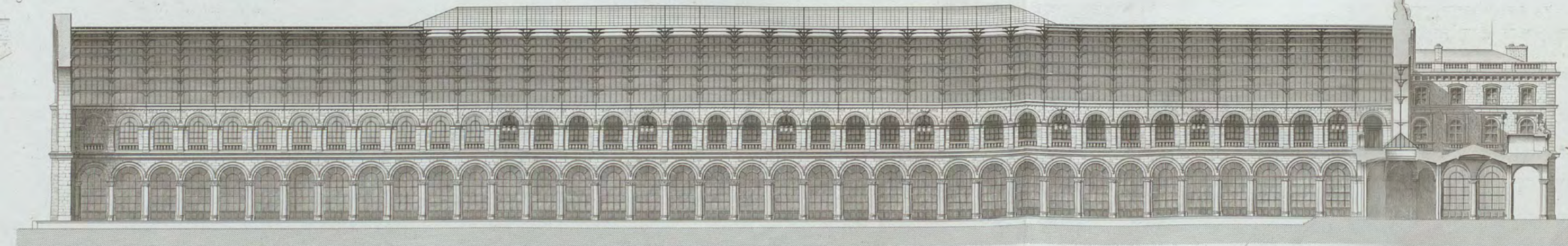
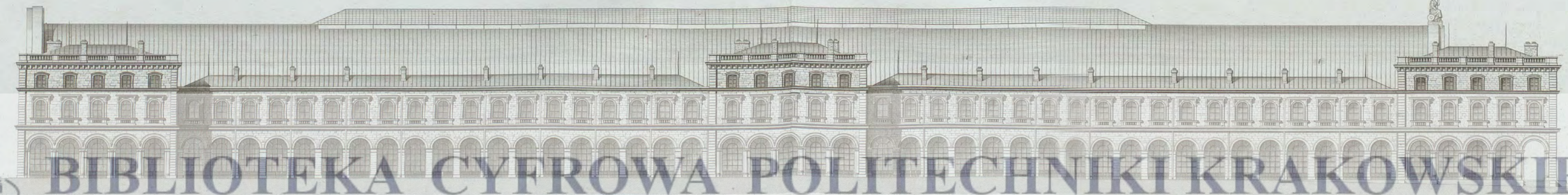

Fig. 6. Elevation latérale projetée (Côte Ouest).



Statue de couronnement du pignon de la façade.



Fig. 10.



Fig. 8. Détail des Salles d'attente.

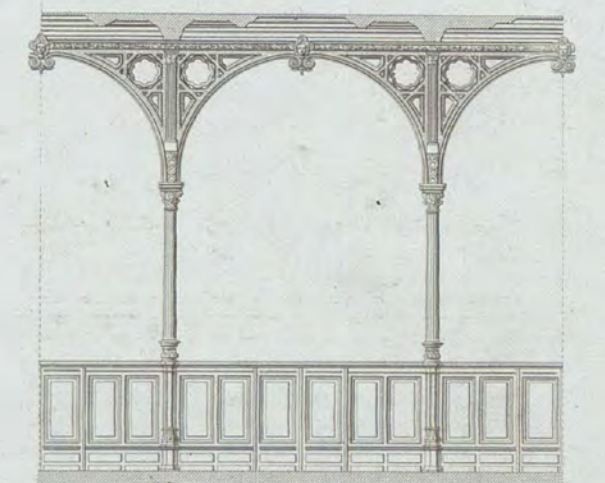
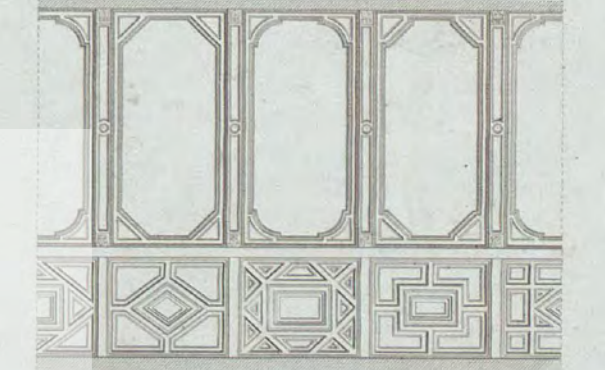

Fig. 13.

Eclairage extérieur de la Gare.



Fig. 9. Plan du Plafond.



BIBLIOTEKA CYFROWA POLITECHNIKI KRAKOWSKIEJ

Echelle des Fig. 1, 2, 4, 5, 6.

Echelle des Fig. 8, 9, 10, 13.







Echelle 0.65 pour mètre

A. Jacquin direct.

Apr. 17. Machines pour le Chemin de l'Est.

L. Guignot del. et sculp.

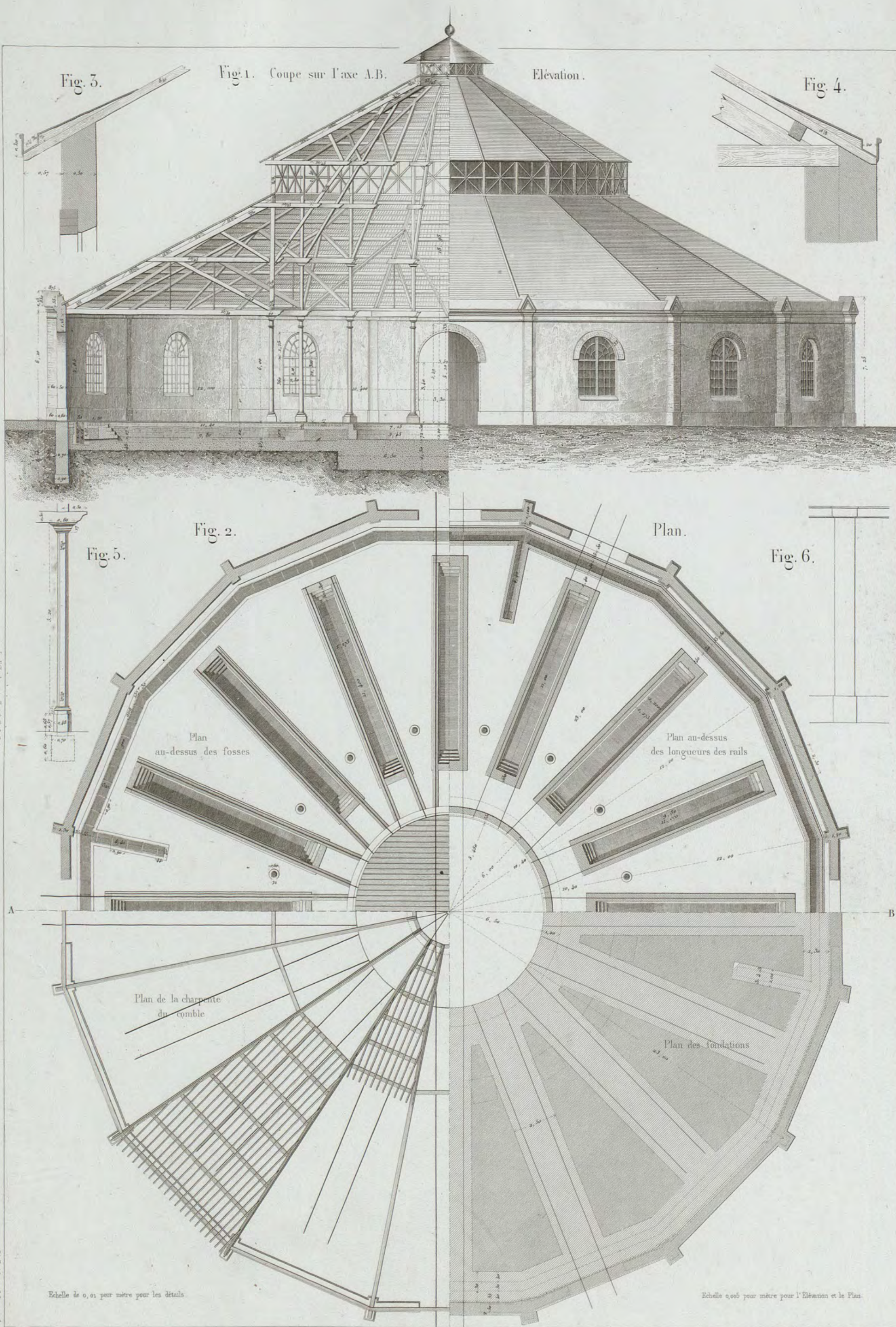

Echelle de 0,01 pour mètre pour les détails

Echelle 0,005 pour mètre pour l'Elevation et le Plan.

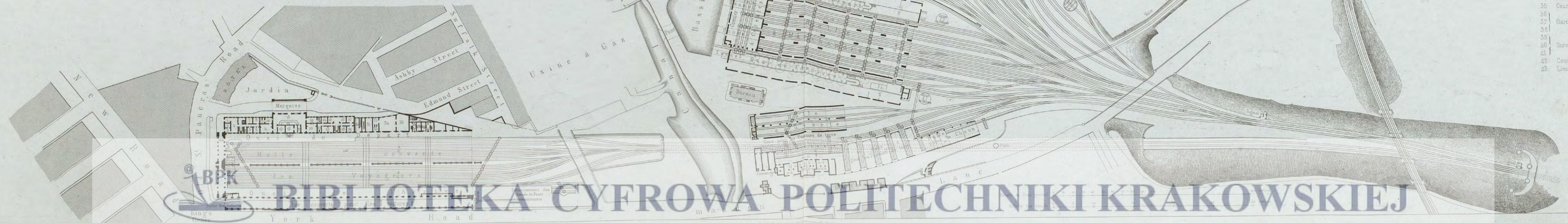
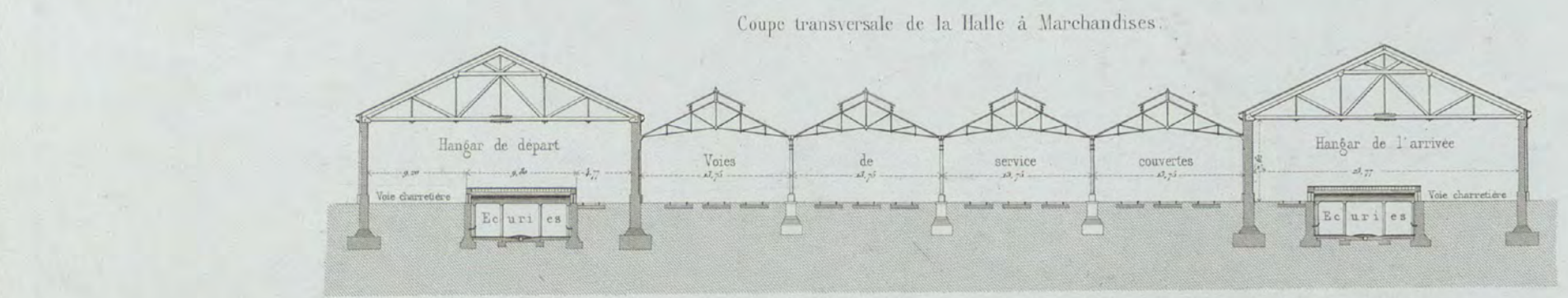
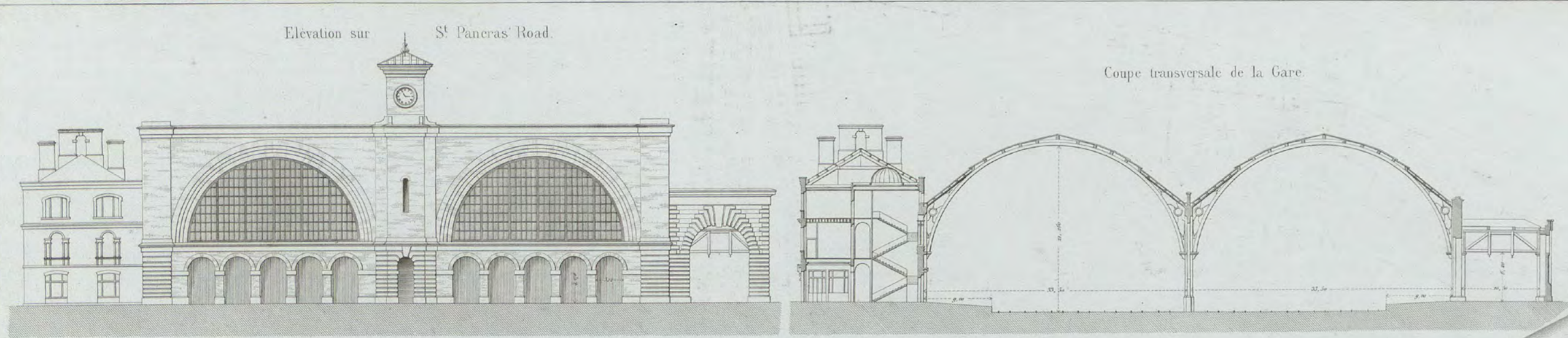

Légende  
du Batiment des Voyageurs

- 1
- 2 Bureaux de l'exploitation commerciale
- 3
- 4
- 5 id. du Télégraphe
- 6
- 7 id. de l'ingénieur resident.
- 8
- 9 Lieux d'aisances.
- 10 Salle d'attente de 2<sup>e</sup> Classe pour les Dames.
- 11 Cabinets pour les Dames
- 12 Vestibule.
- 13 Distribution de Billets.
- 14 Chef de Gare
- 15 Pièces à l'abri du feu pour les archives.
- 16 Inspecteur de la Gare
- 17 Librairie.
- 18
- 19 Salle d'attente de 1<sup>re</sup> Classe pour les dames.
- 20 id. id. id.
- 21 Cabinets pour les dames.
- 22 Lieux d'aisances.
- 23 Buffet.
- 24 Bureaux de la traction.
- 25
- 26 Bureaux du surintendant.
- 27
- 28
- 29
- 30 Lieux d'aisances pour les hommes.
- 31 Objets perdus.
- 32
- 33
- 34 Facteurs.
- 35 Messageries.
- 36 Cour couverte pour messageries.
- 37
- 38 Gardes.
- 39
- 40 Surveillants.
- 41
- 42 Cour.
- 43 Lieux d'aisances.

Fig. 1. Plan de la gare des voyageurs.

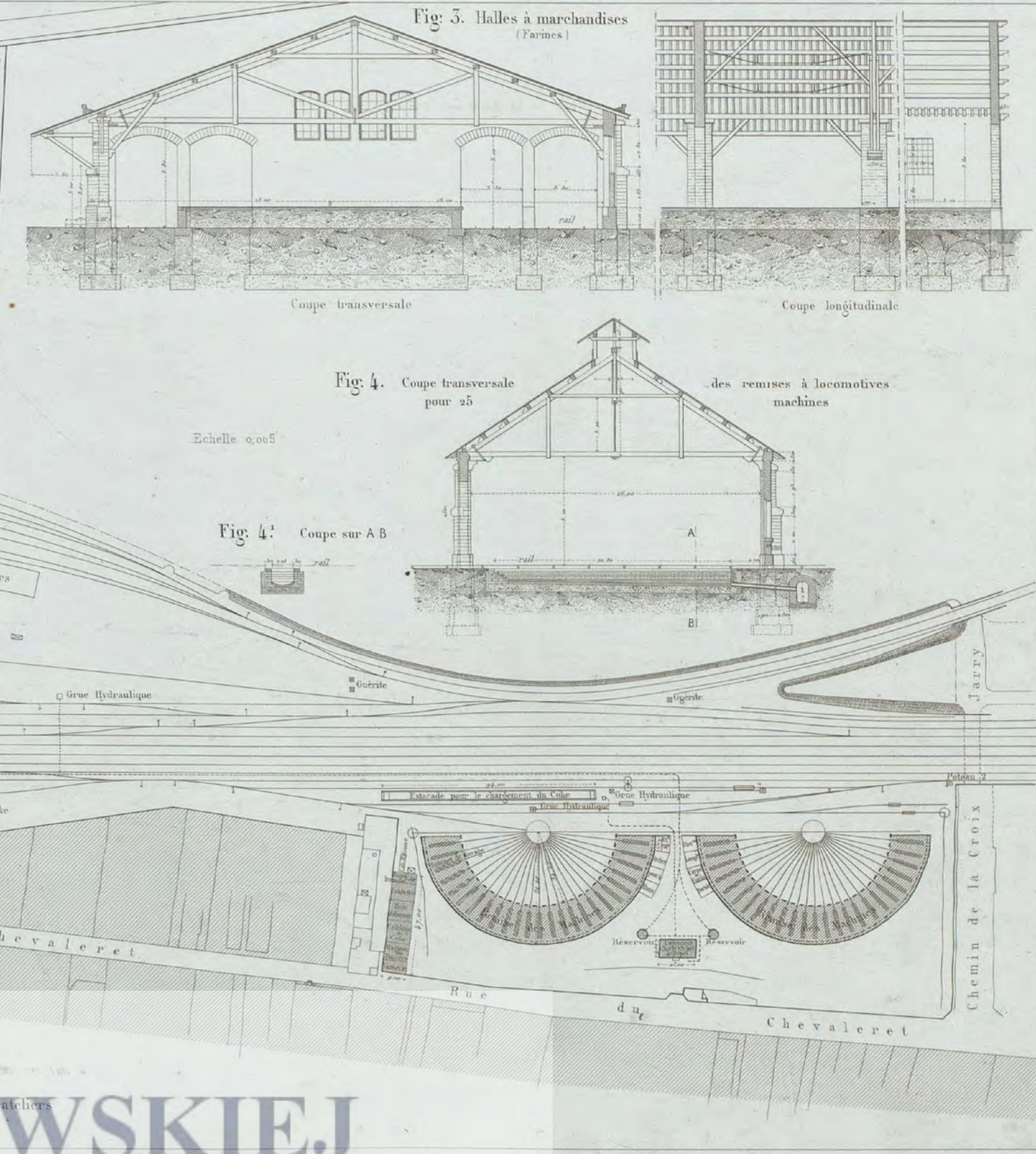
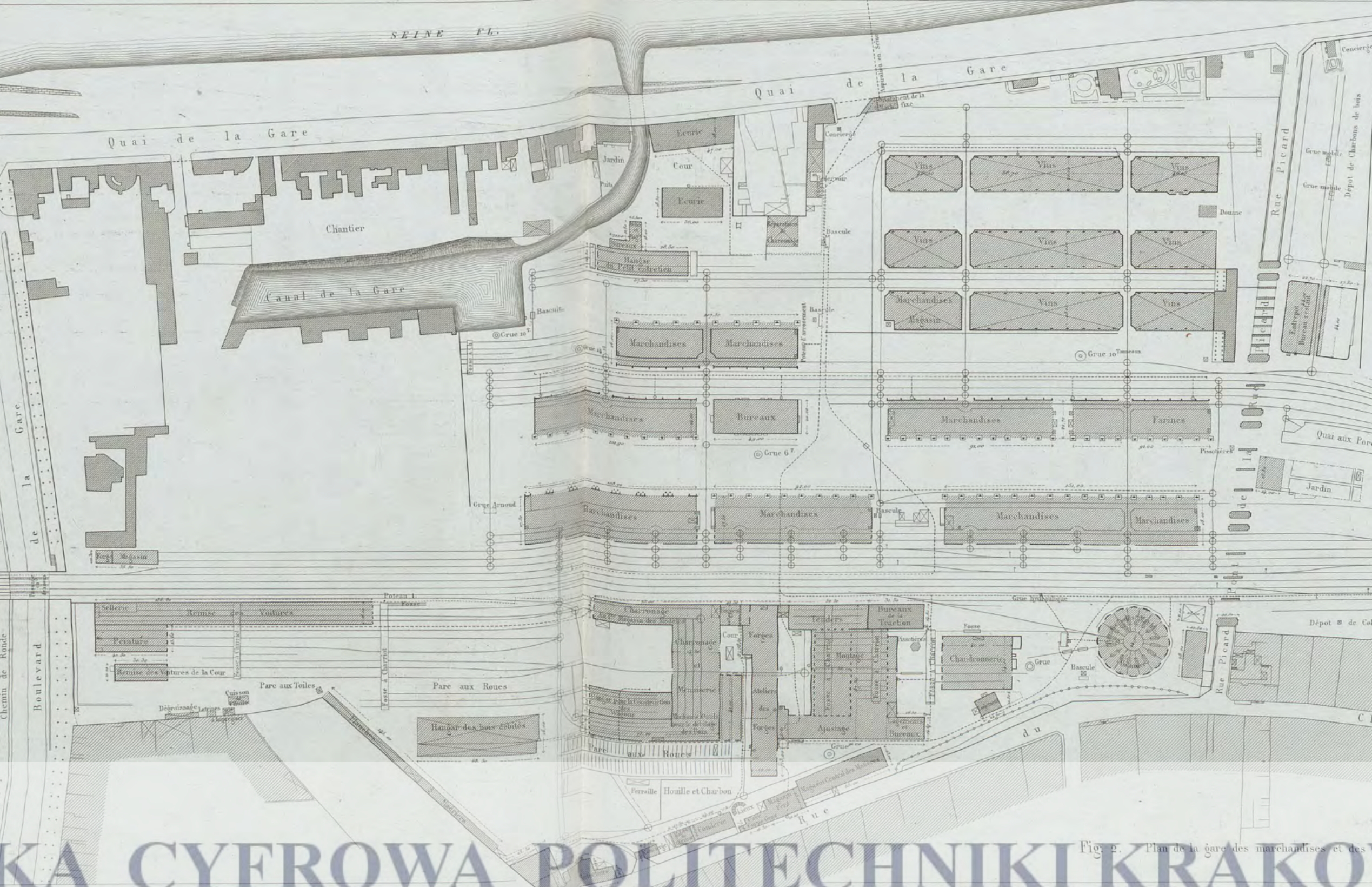
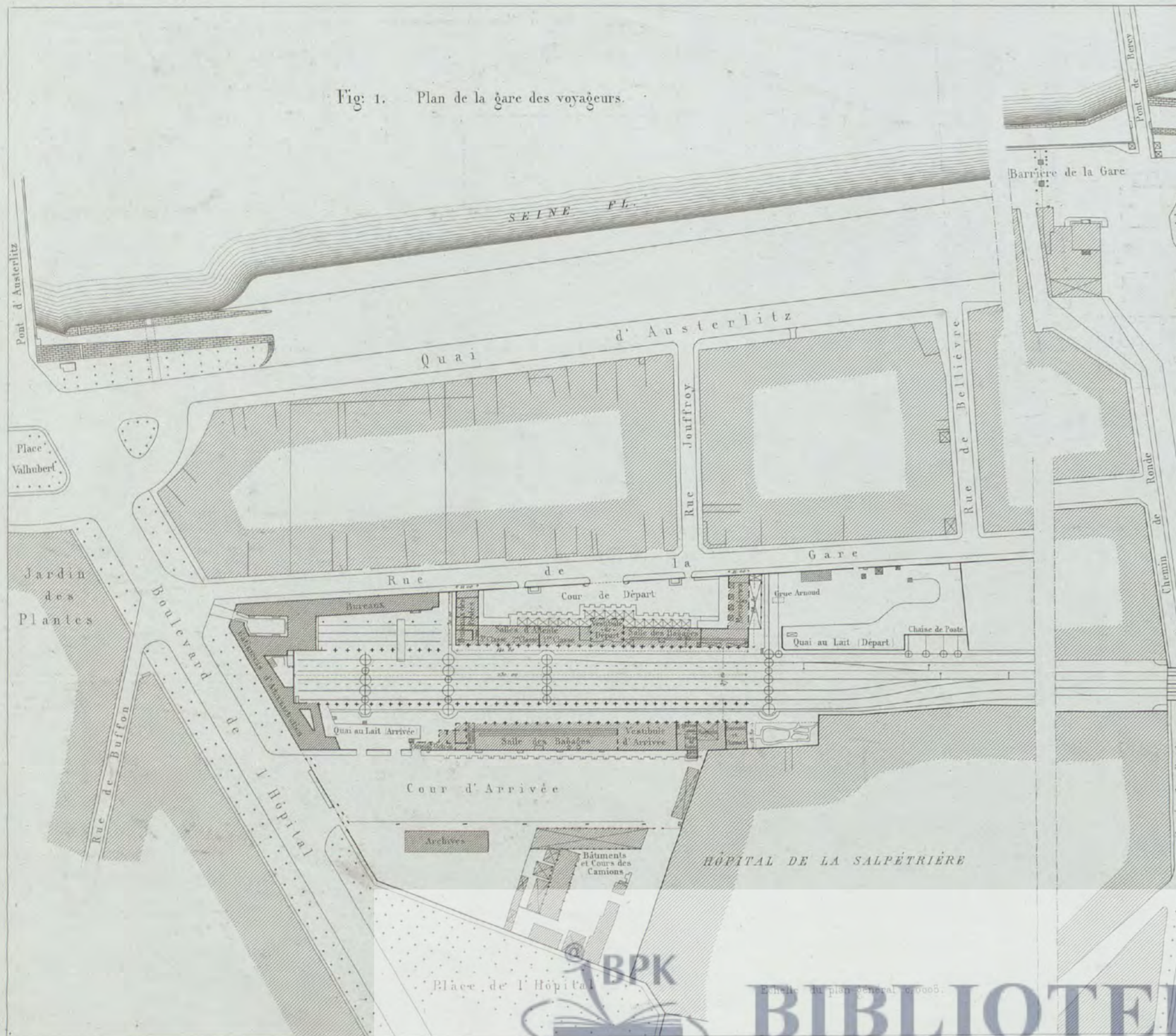

Fig. 2. Plan de la gare des marchandises et des ateliers.

BIBLIOTEKA CYFROWA POLITECHNIKI KRAKOWSKIEJ

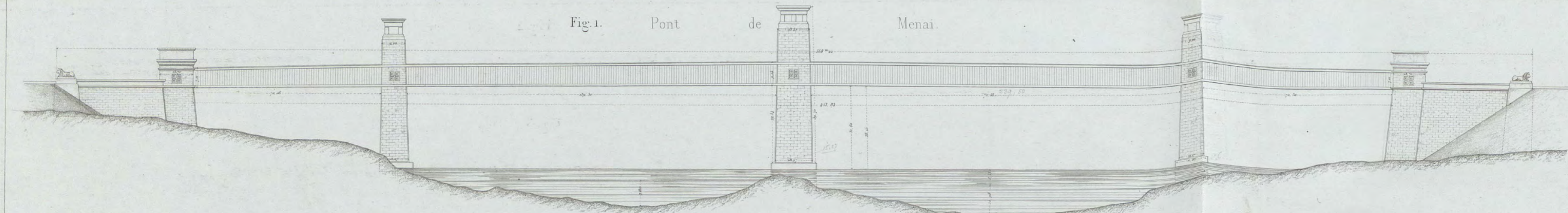

Fig. 1. Pont de Menai.

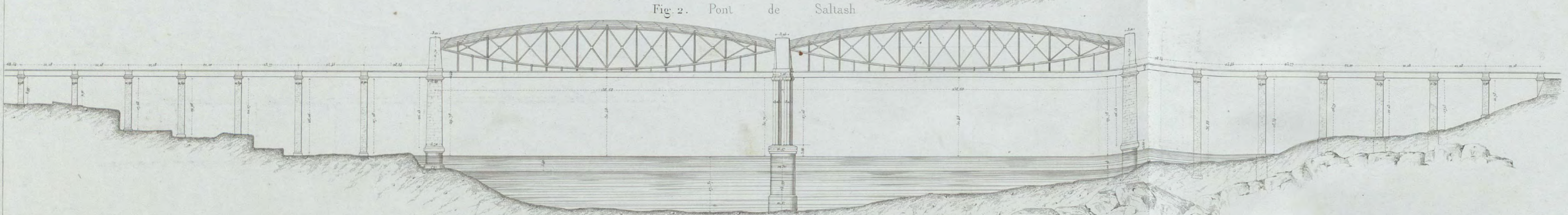

Fig. 2. Pont de Saltash.



Fig. 3. Viaduc de Crumlin.

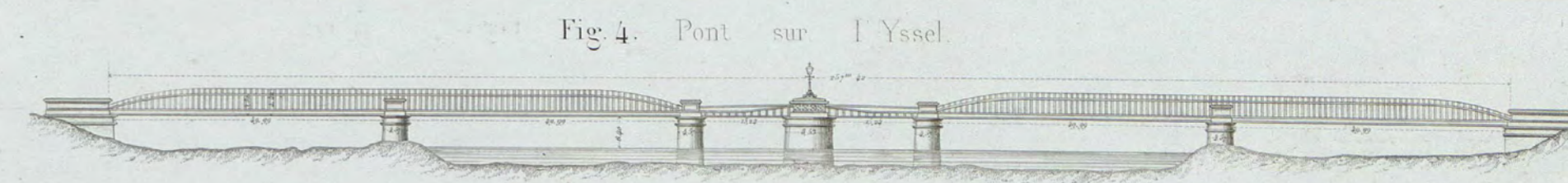

Fig. 4. Pont sur l'Yssel.

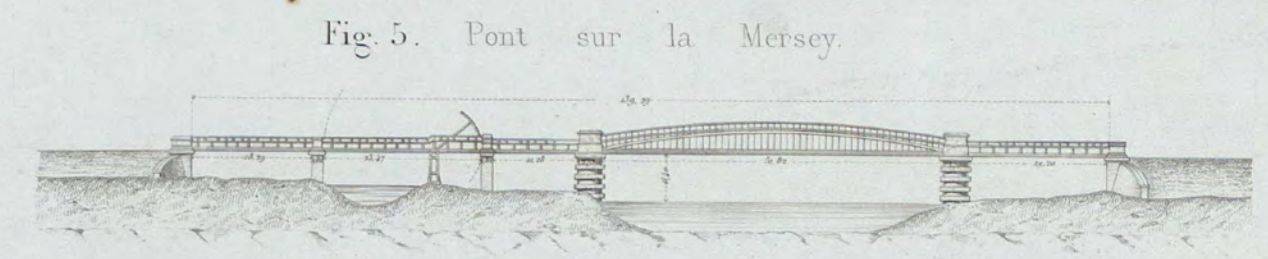

Fig. 5. Pont sur la Mersey.

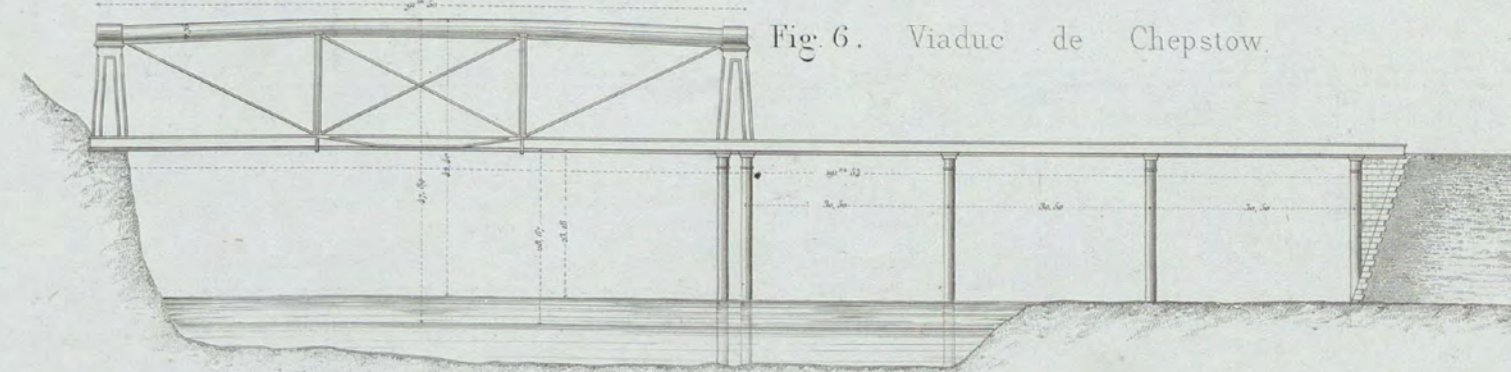

Fig. 6. Viaduc de Chepstow.

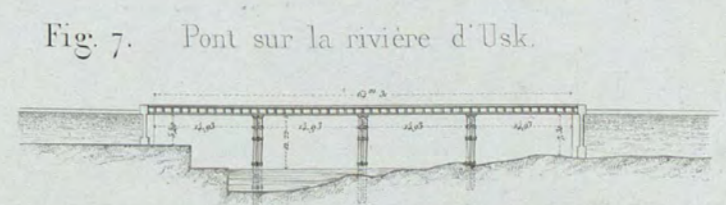

Fig. 7. Pont sur la rivière d'Usk.



Fig. 8. Pont sur la Wye.

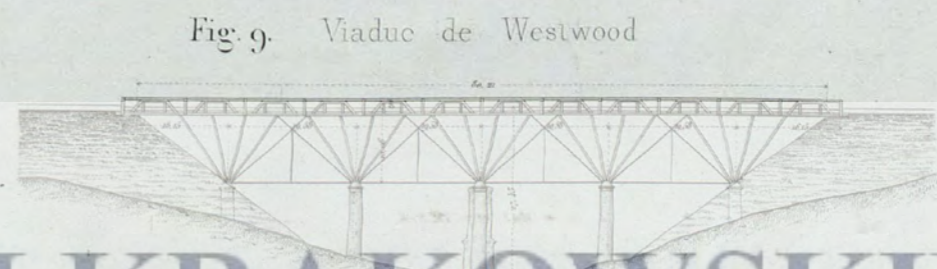

Fig. 9. Viaduc de Westwood.

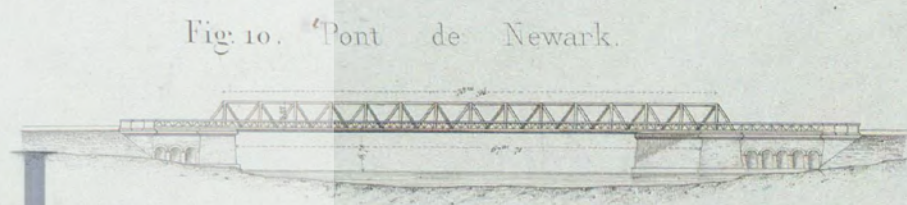

Fig. 10. Pont de Newark.



BIBLIOTEKA CYFROWA POLITECHNIKI KRAKOWSKIEJ



Fig. 2. Pont et Viaduc construits à Nogent sur Marne. (près Paris)  
Plan.



Fig. 5. Elevation 800 Côté de Chaumont.  
Longueur totale 600 mètres.

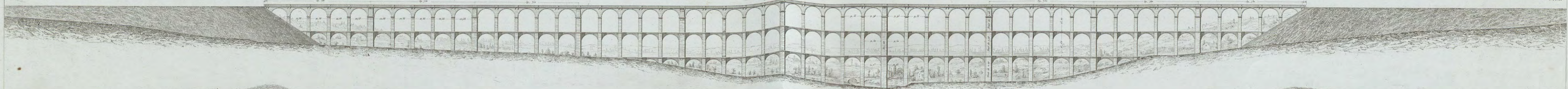

Viaduc sur la Suisse, construit à Chaumont (Haute-Marne)  
Fig. 4. Plan.



BIBLIOTEKA CYFROWA POLITECHNIKI KRAKOWSKIEJ

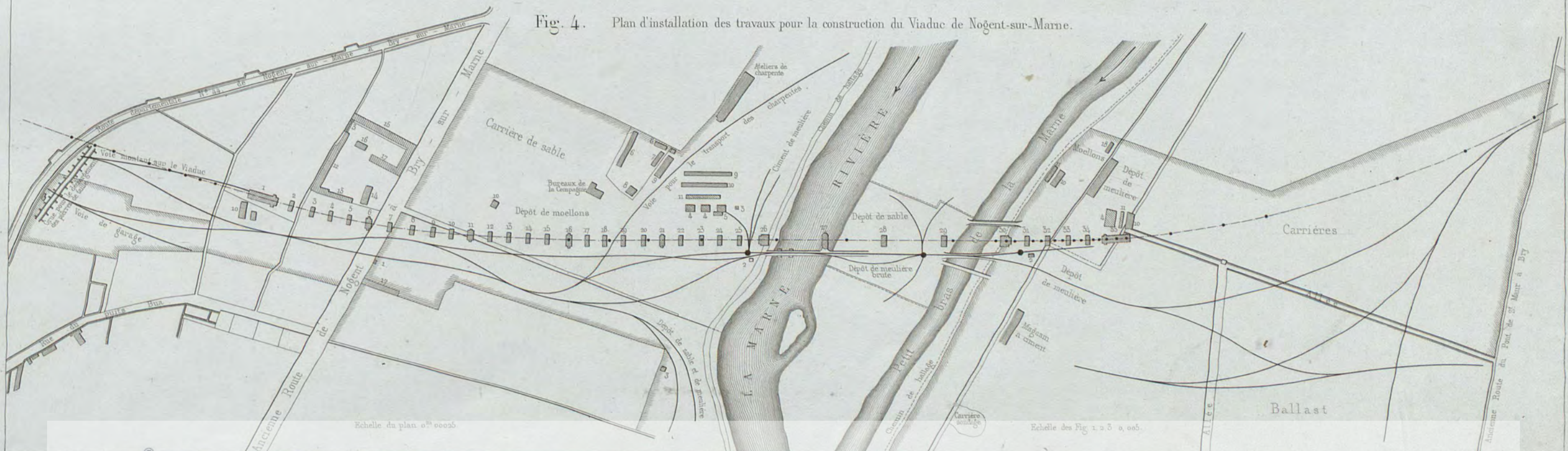
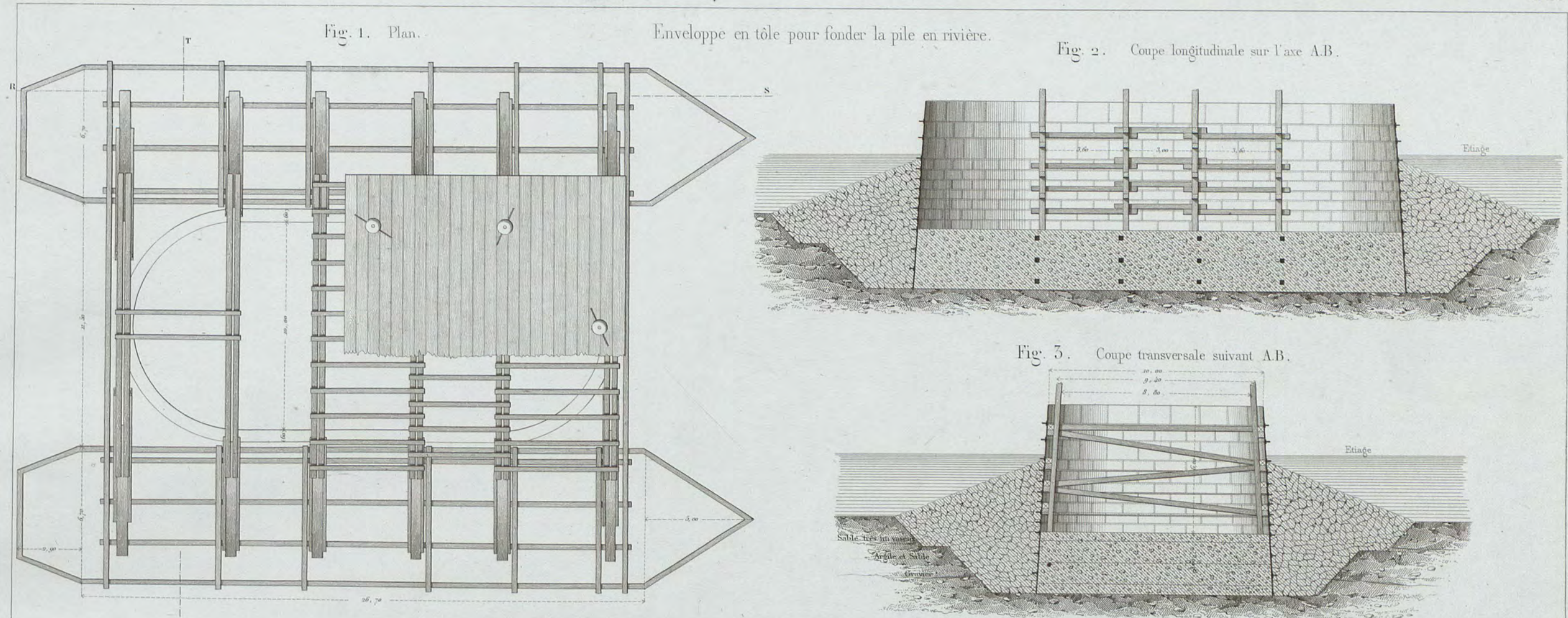

A. Jacquin direct.

Imp. J. Chardon, 101, 103, 105, Boulevard des Capucines, Paris.

L. Guignot del. et sc.





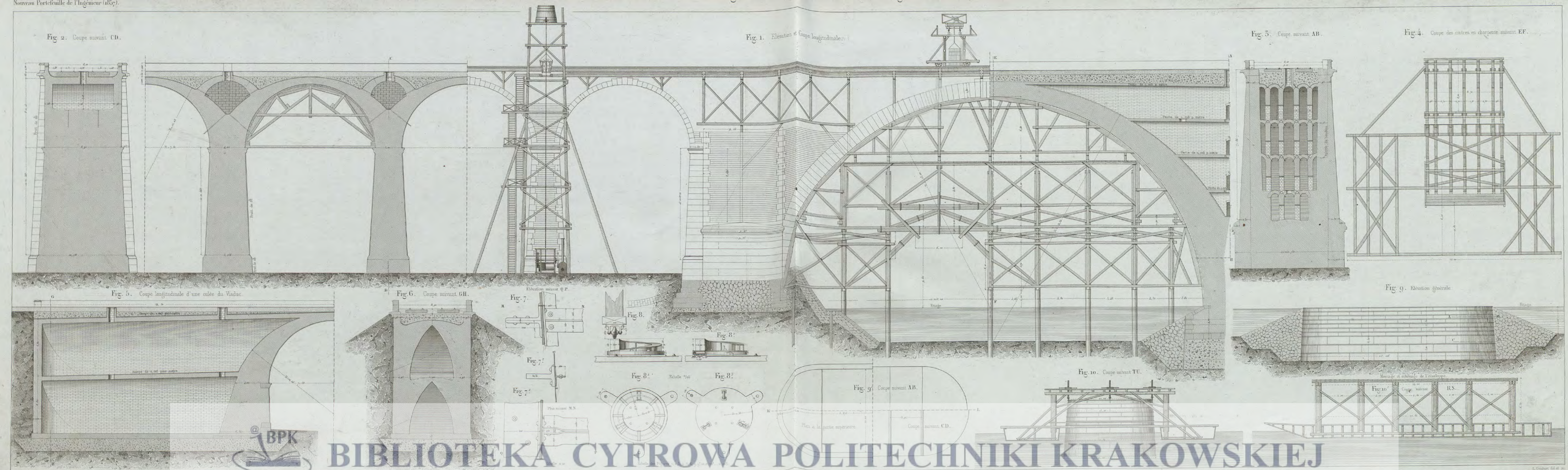

BIBLIOTEKA CYFROWA POLITECHNIKI KRAKOWSKIEJ

Fig. 6. Manège central (Élev. côté nord).

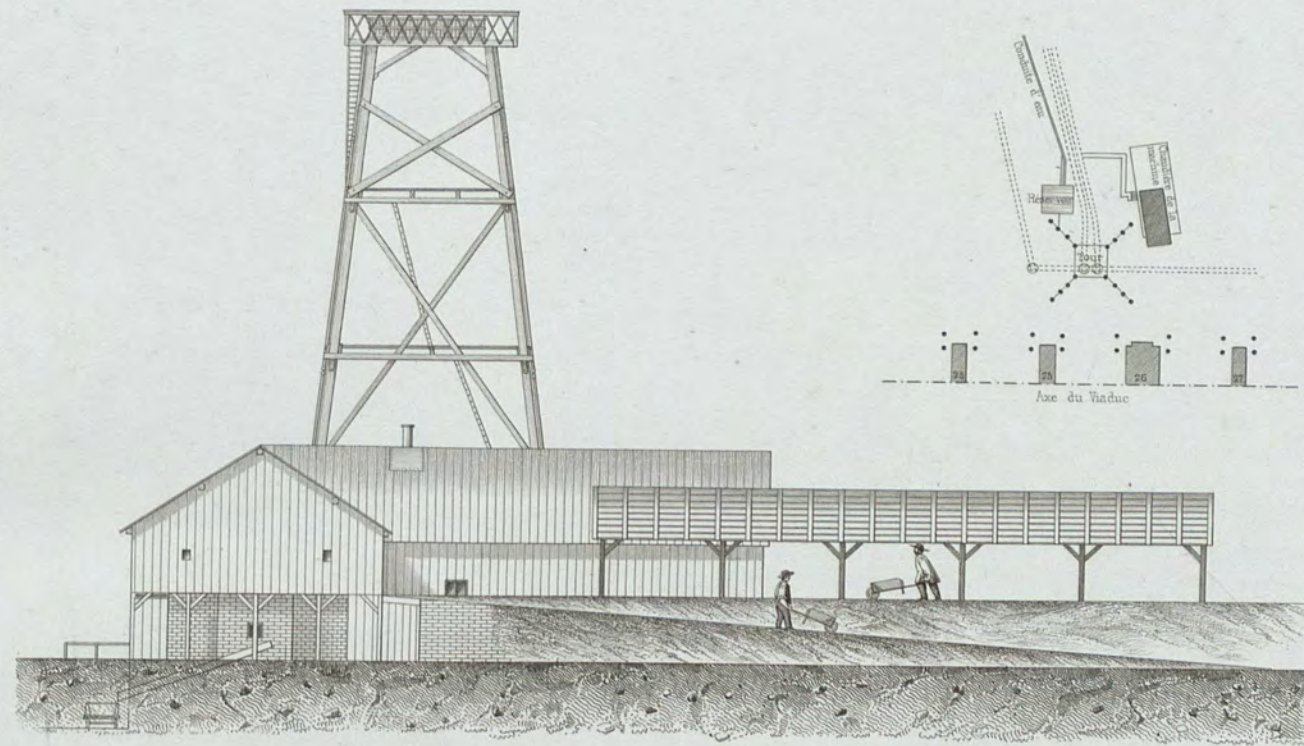

Fig. 4. Plan de la Tour centrale.

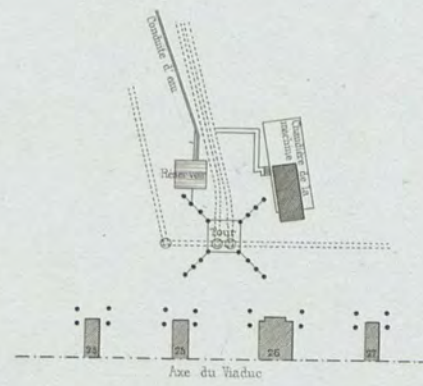

Fig. 5. Plan de la Tour Est.

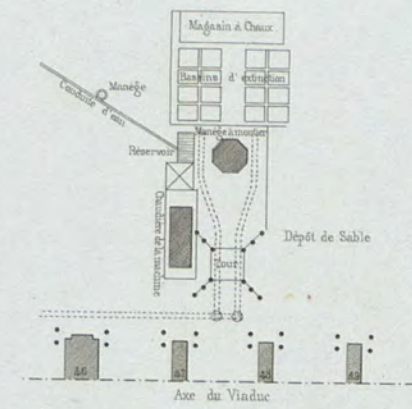

Fig. 7. Manège central (Élev. côté sud).

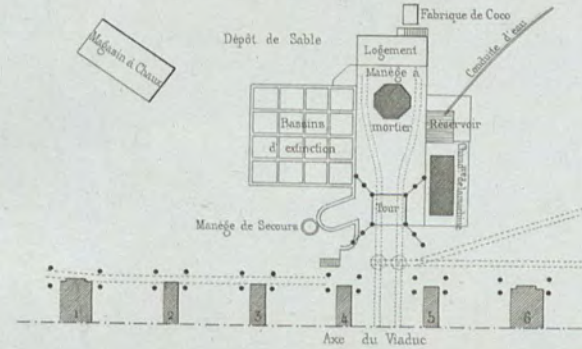
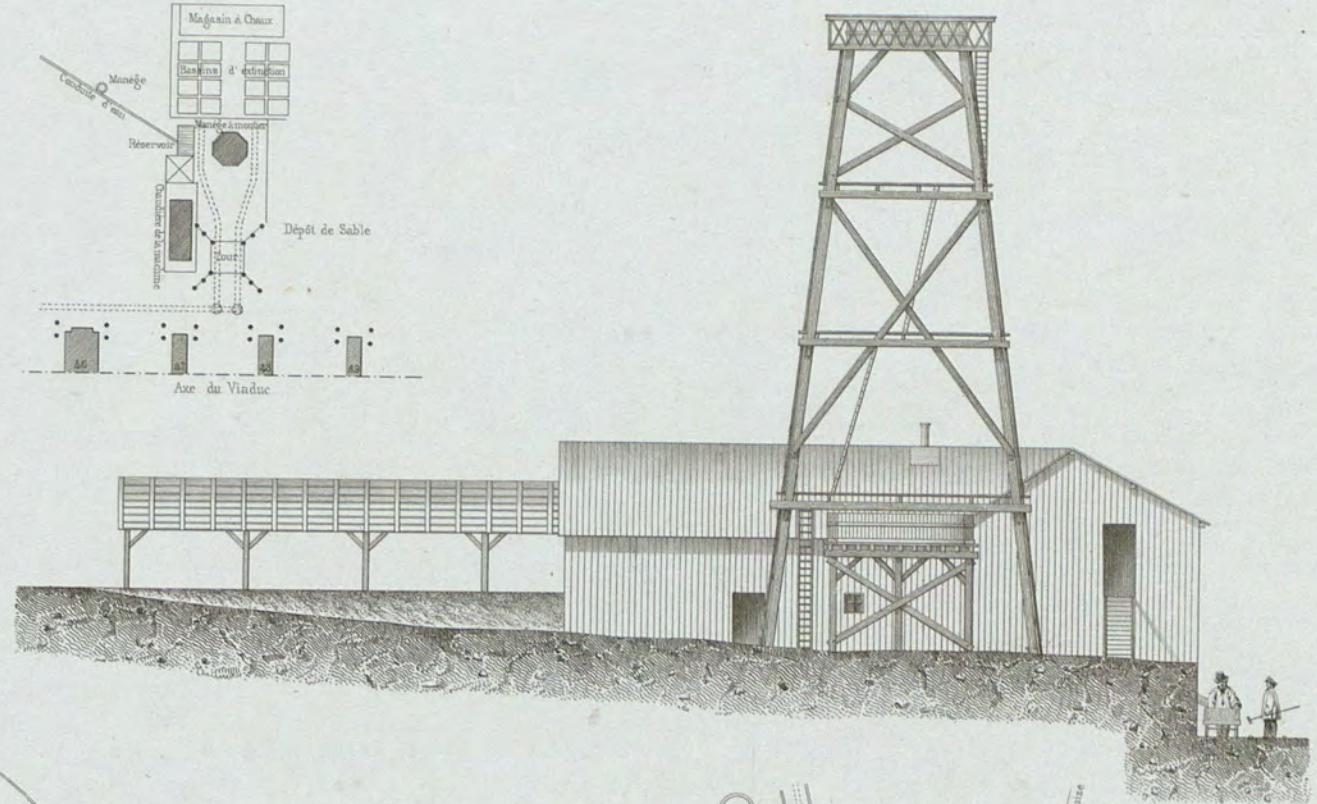

Fig. 5. Plan de la Tour Ouest.

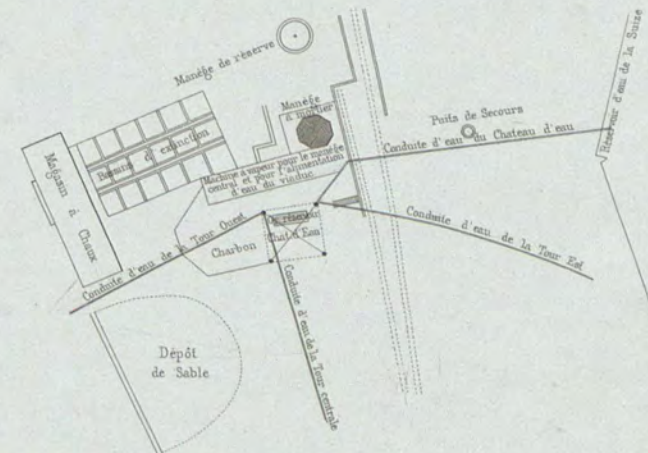

Fig. 2. Plan du manège central.

Les lignes ponctuées indiquent les voies de service établies provisoirement pour le transport des matériaux.

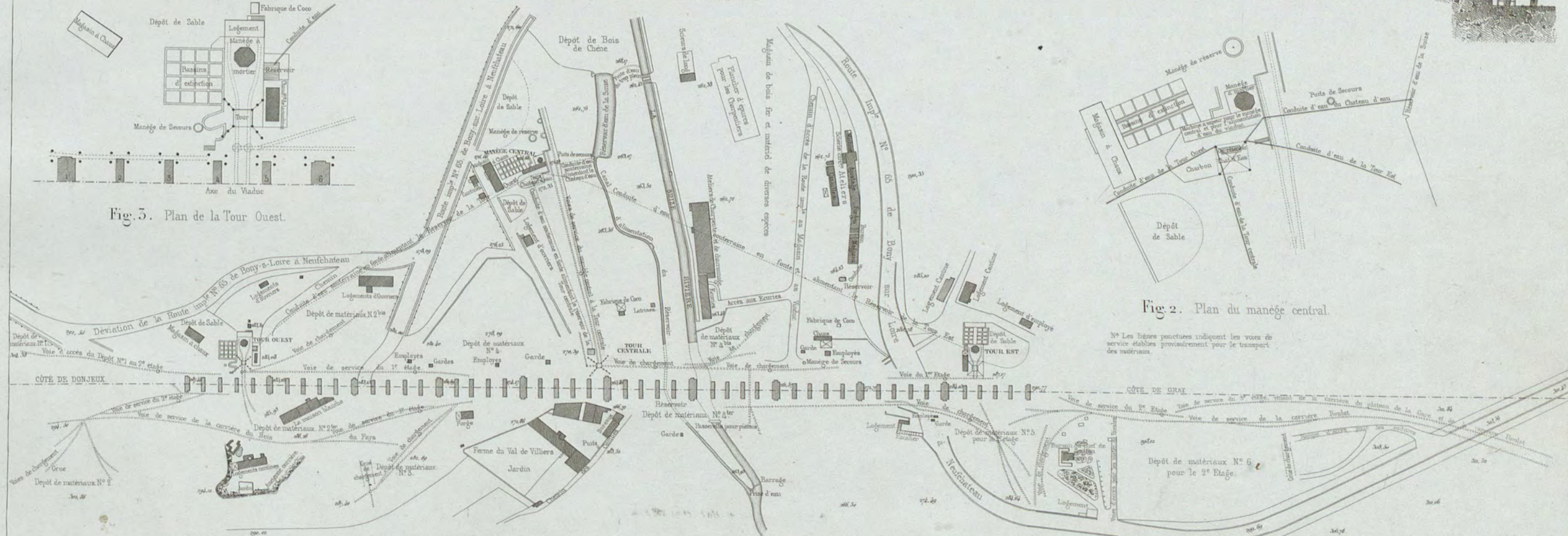

Fig. 1. Plan général.

Echelle des Fig. 6, 7. — 0<sup>m</sup> 004

Echelle du plan général 0 000335

Echelle des Fig. 2, 3, 4 et 5. — 0<sup>m</sup> 001

A. Jacquin dess.



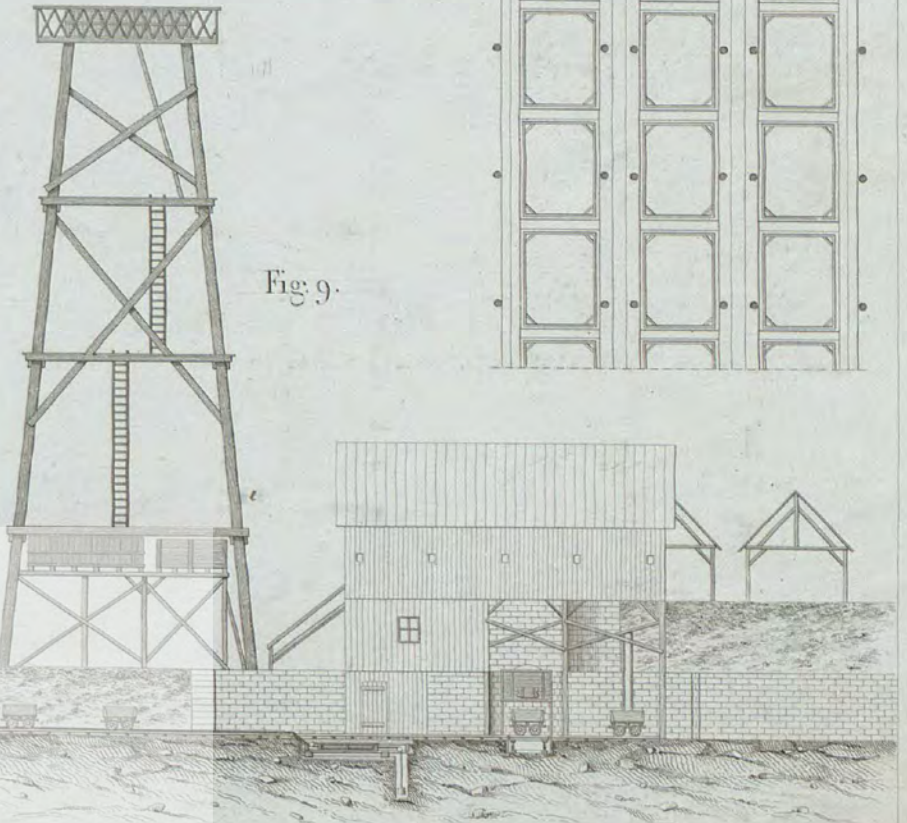
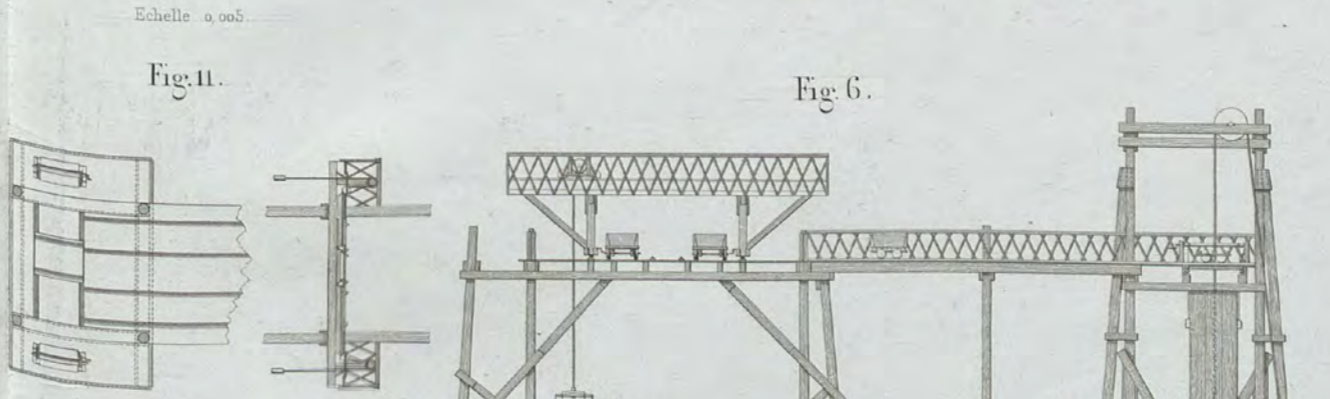
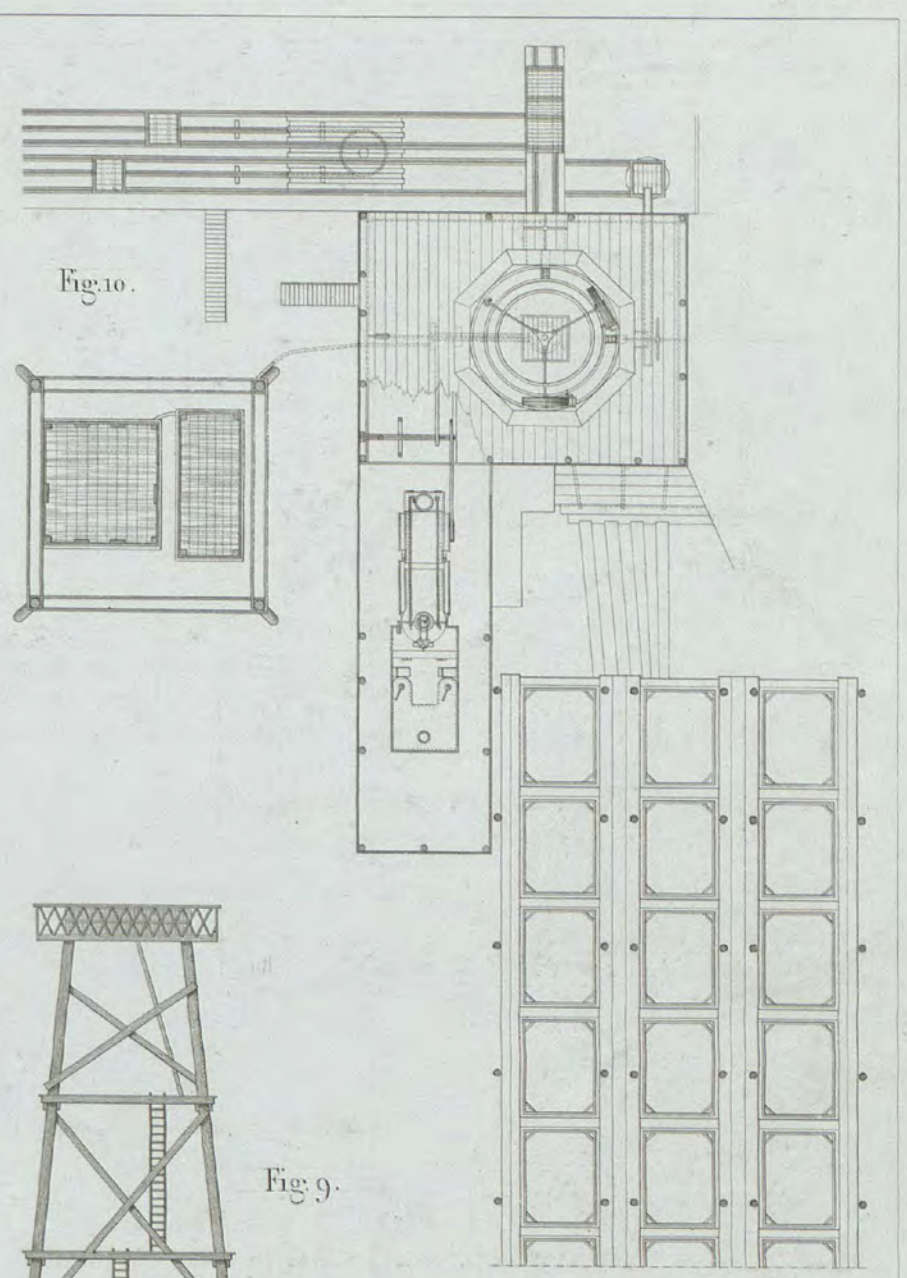
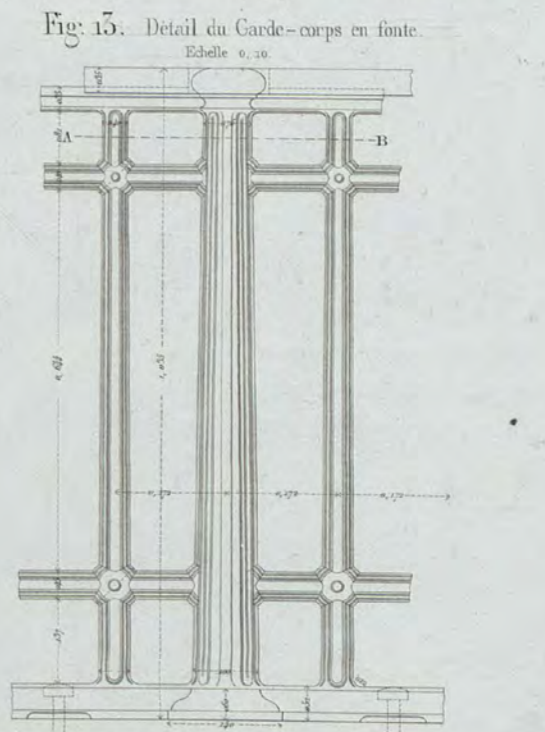
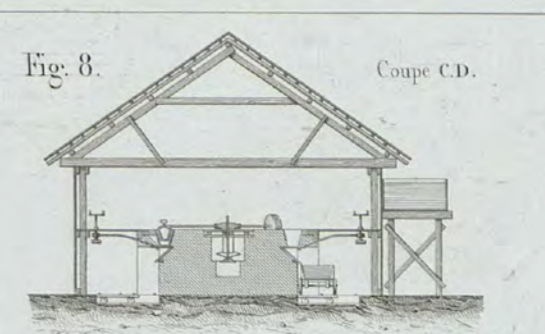
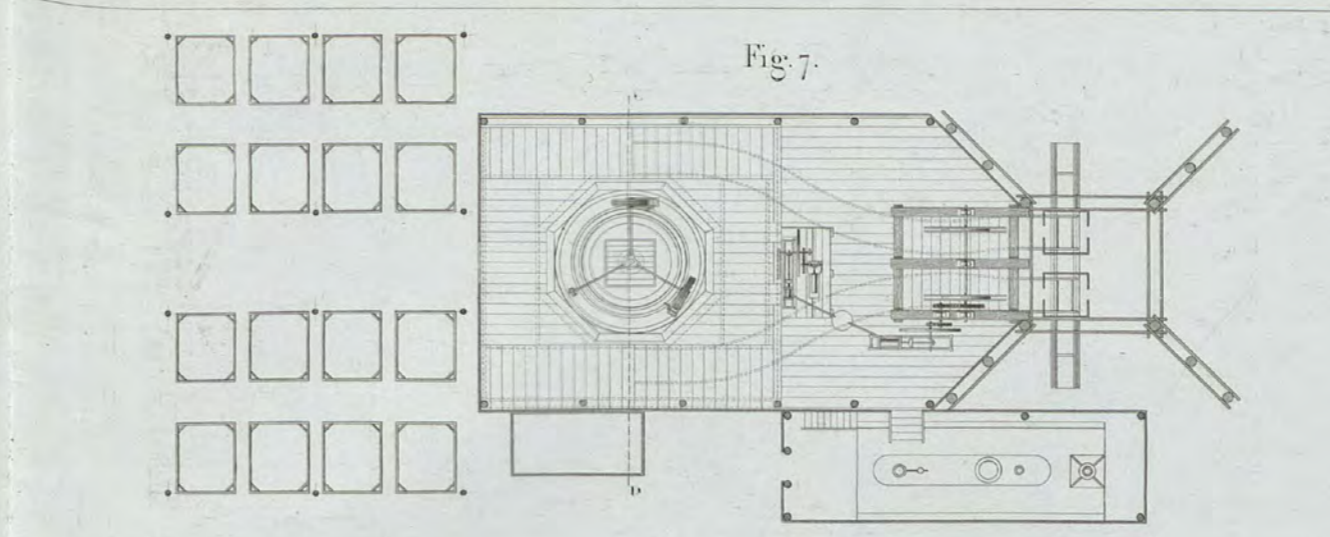
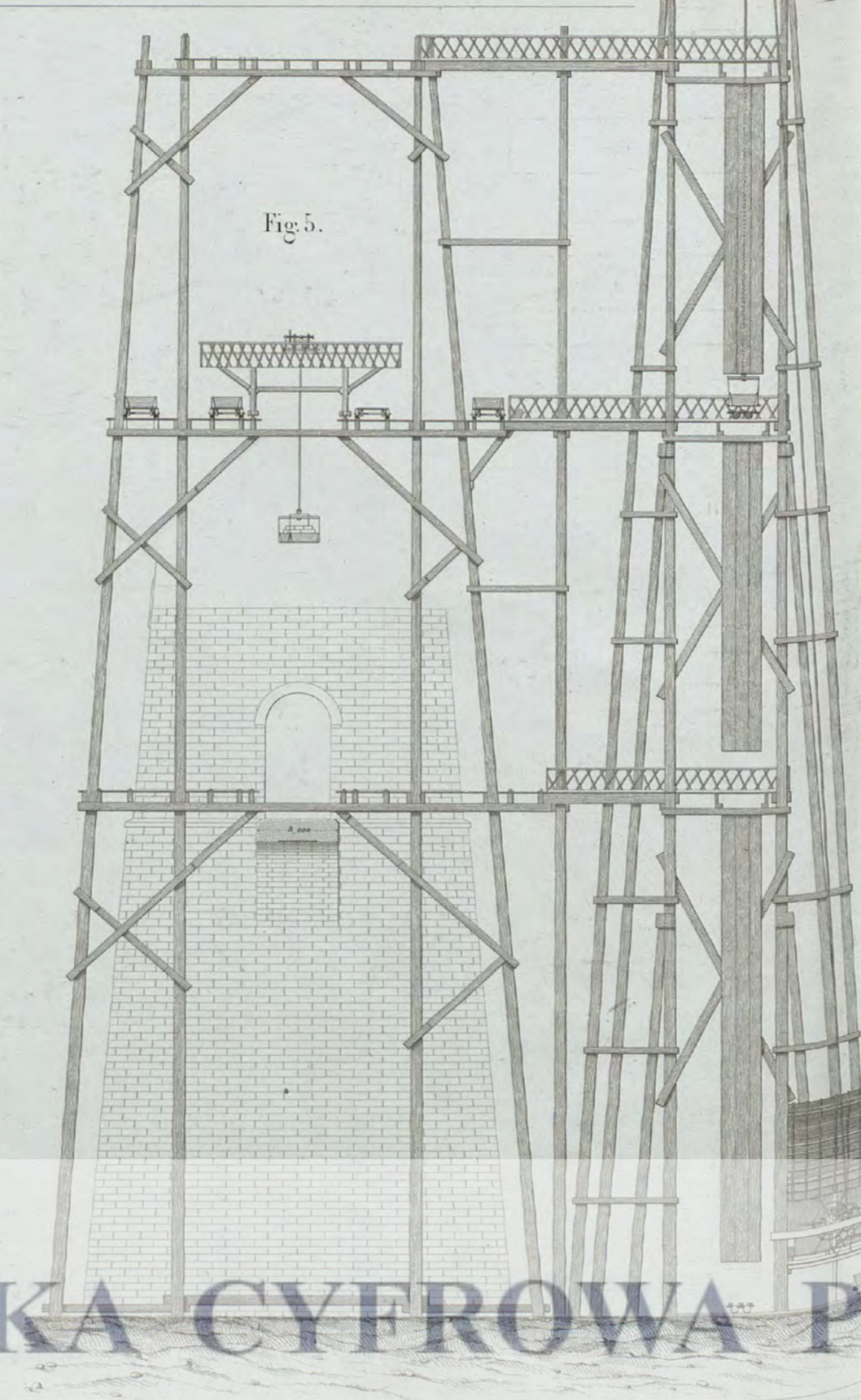
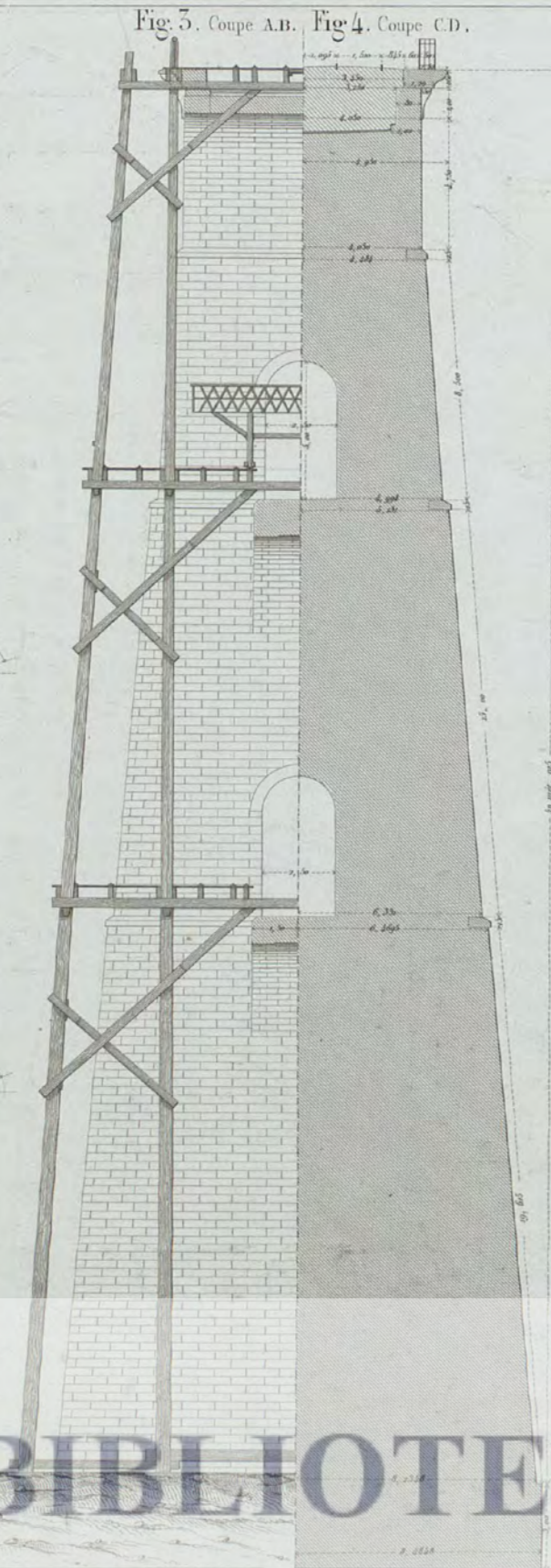
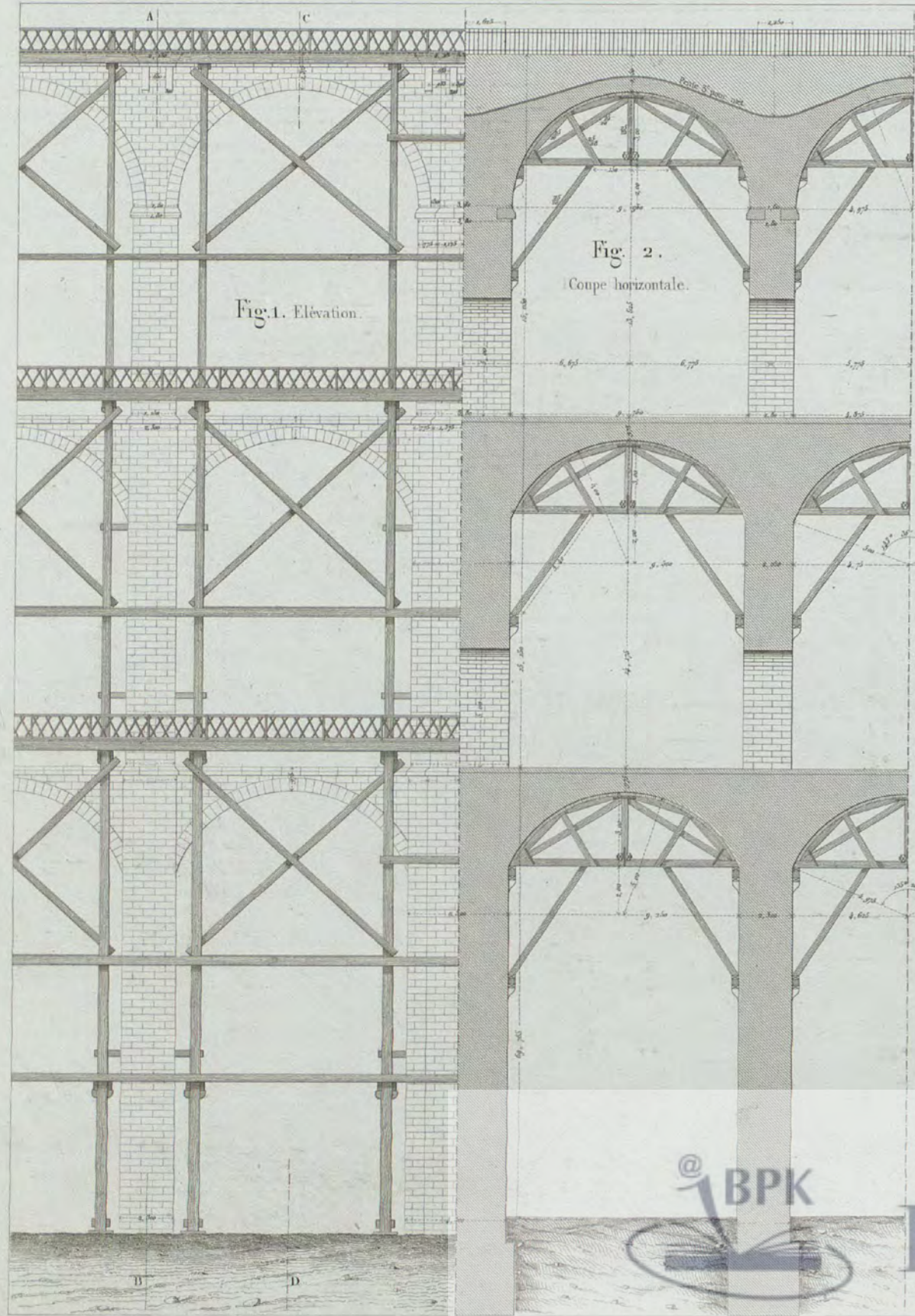

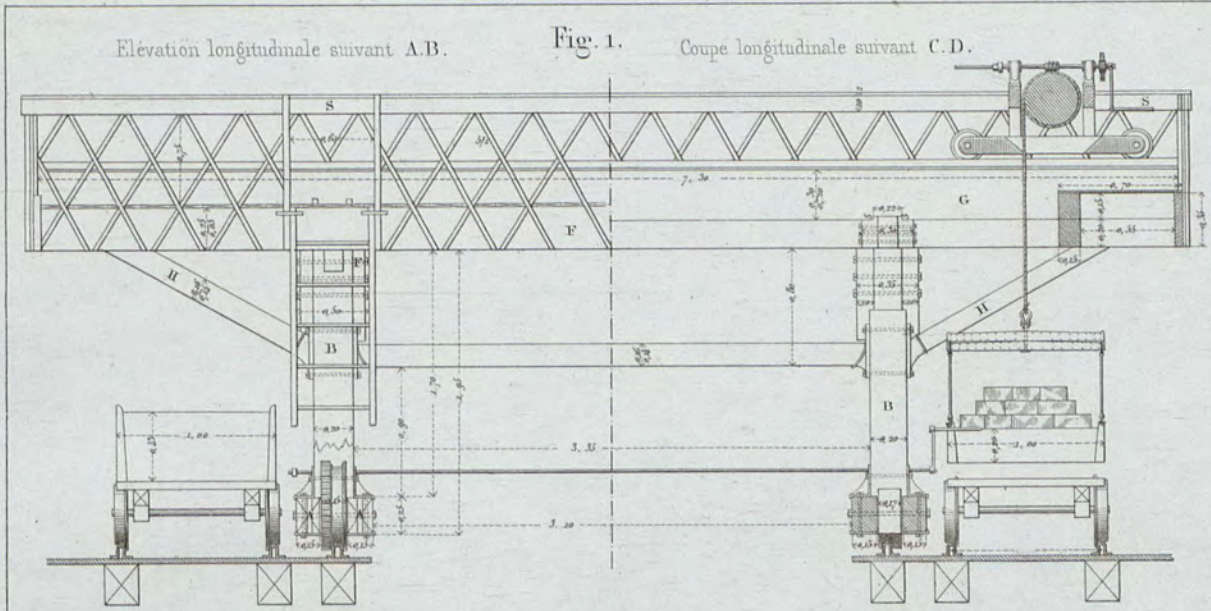
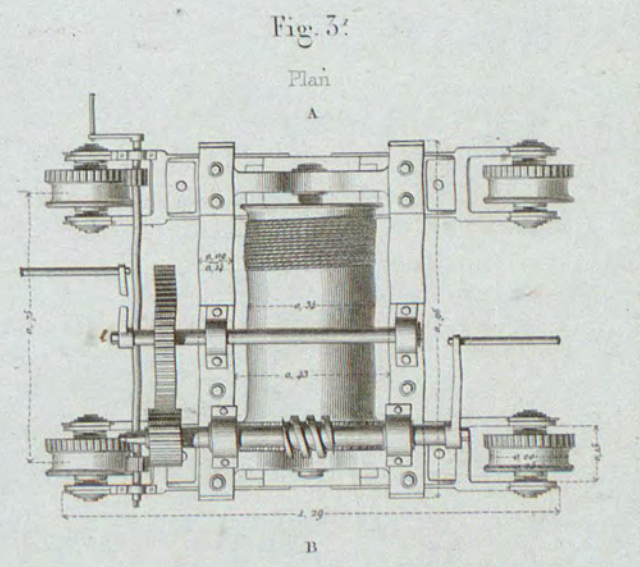
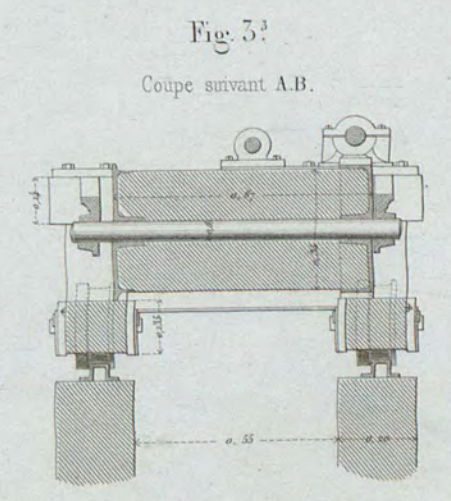
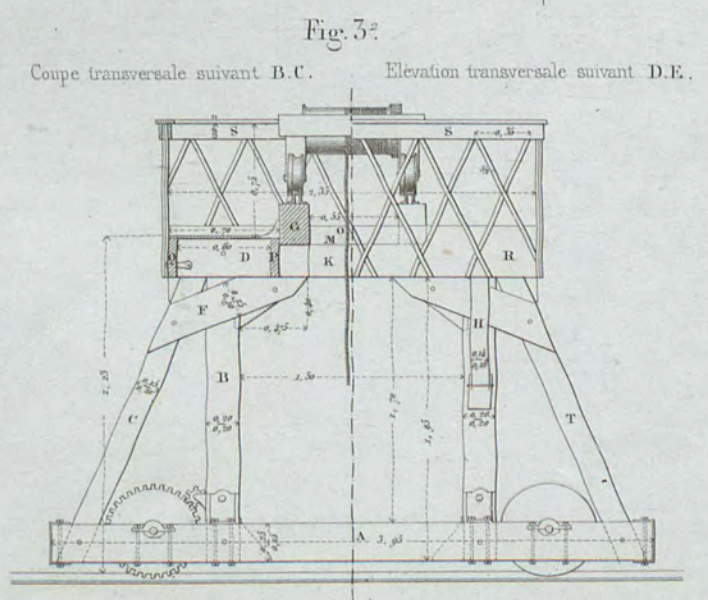
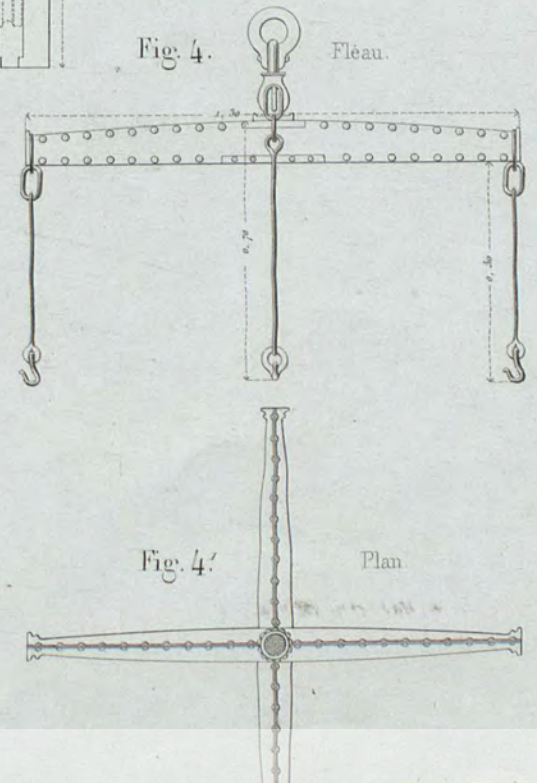
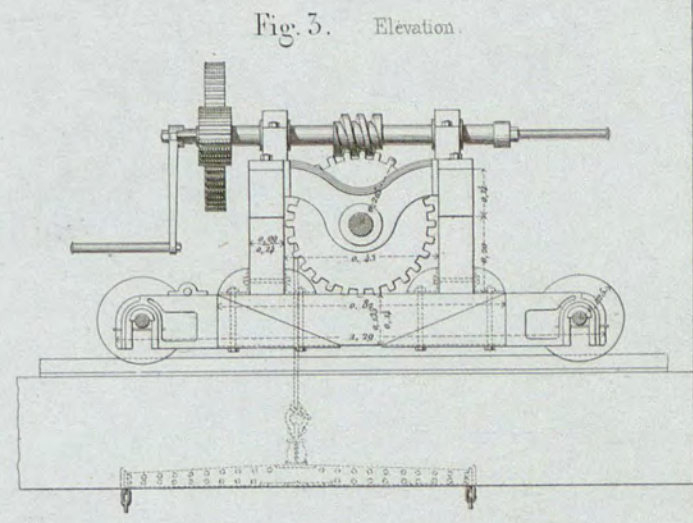
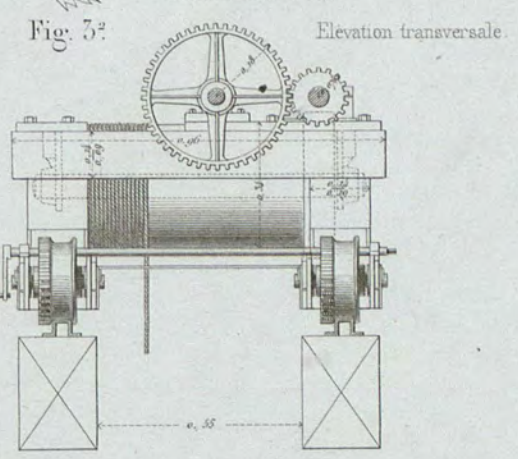
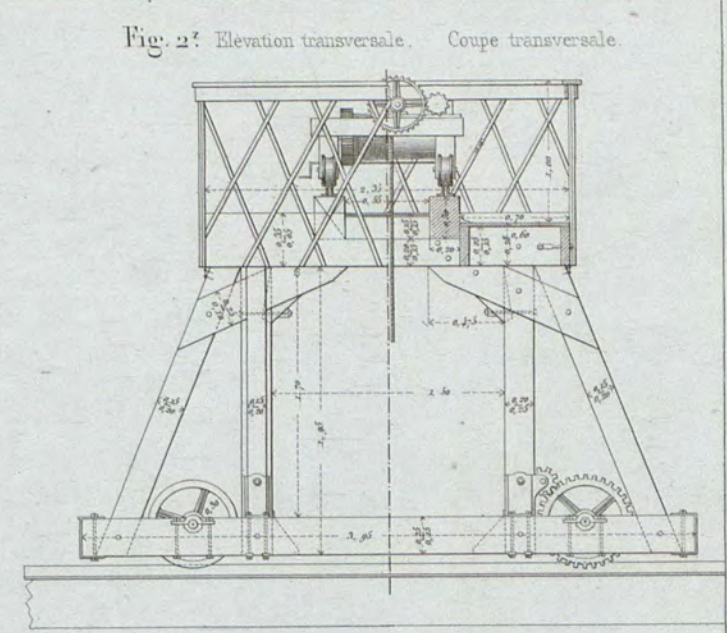
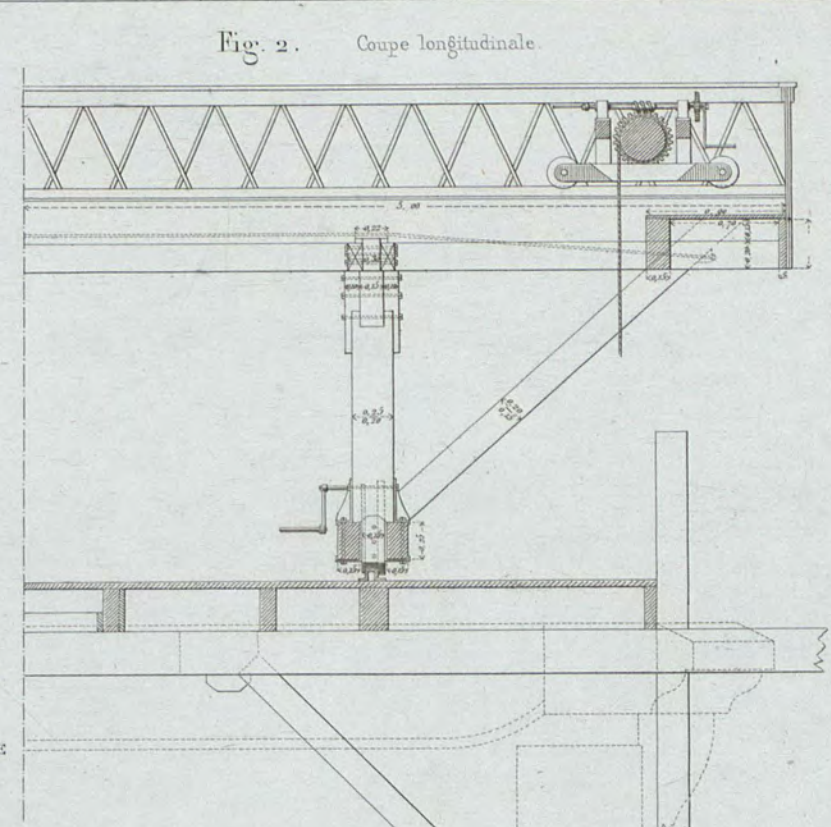
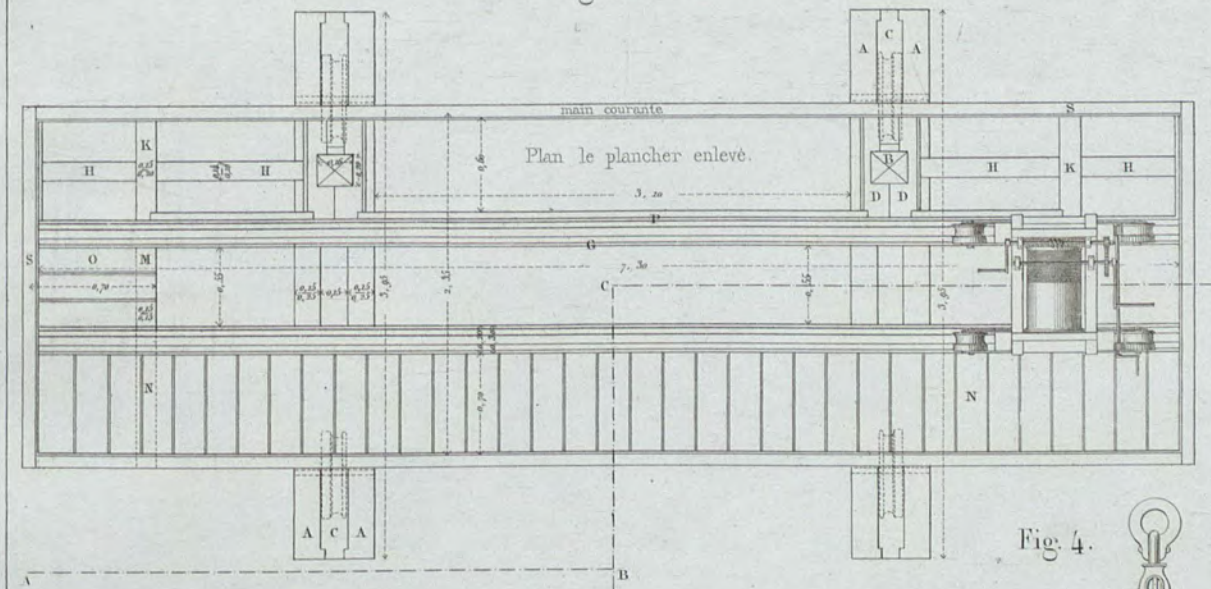

Fig. 1: Plan



Echelle 0<sup>m</sup>02 pour les Fig. 1, 1', 2, 2', 3, 3', 3'', 4, 4'

Truc.

Fig. 1.

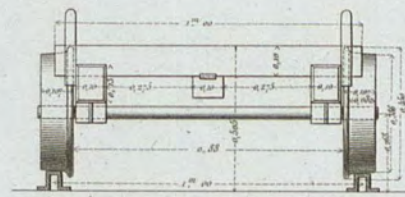

1<sup>z</sup>

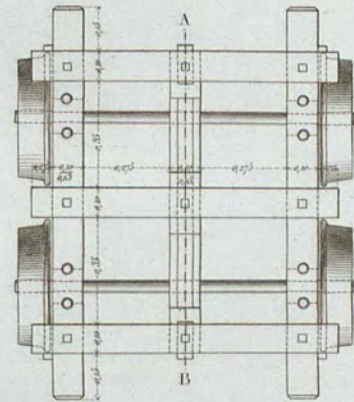

1<sup>z</sup> Coupe A.B.

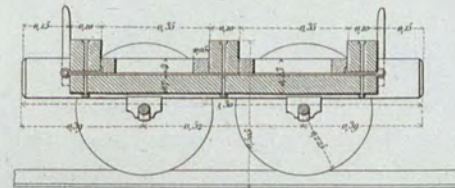

8<sup>z</sup>

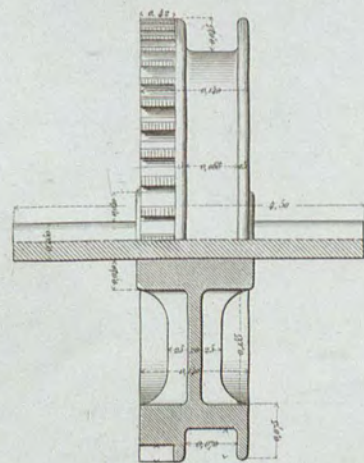

Caisses à mortier.

Fig. 2.



2<sup>z</sup>

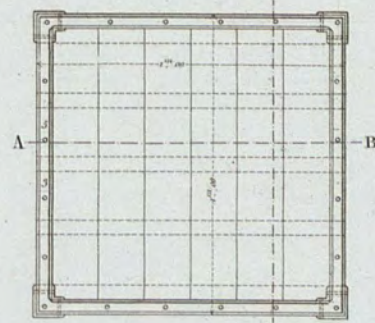

2<sup>z</sup> Coupe A.B.

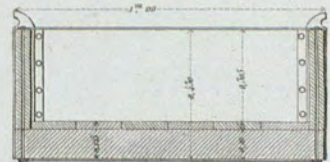

2<sup>z</sup> Coupe C.D.

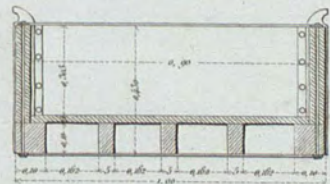

Fig. 8.

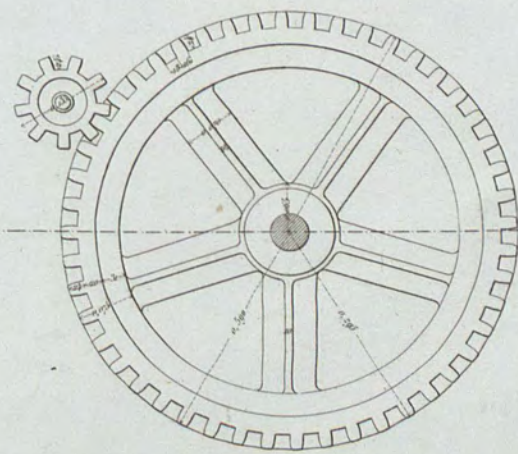
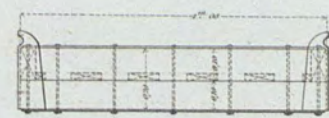
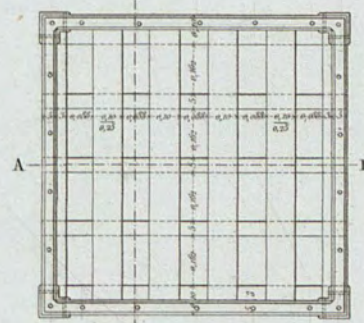

Fig. 3.



3<sup>z</sup>



3<sup>z</sup> Coupe A.B.

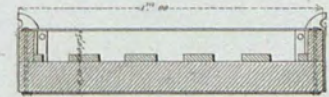

3<sup>z</sup>

Coupe C.D.

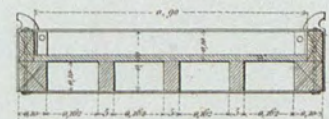

Fig. 9.

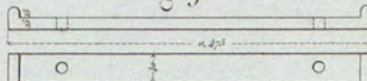

Fig. 10.

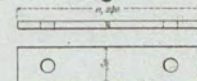
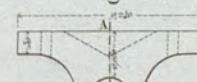

Fig. 11.



11<sup>z</sup> Coupe A.B.

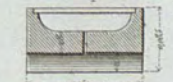
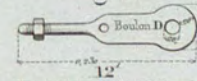

Fig. 12.



12<sup>z</sup>

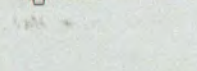
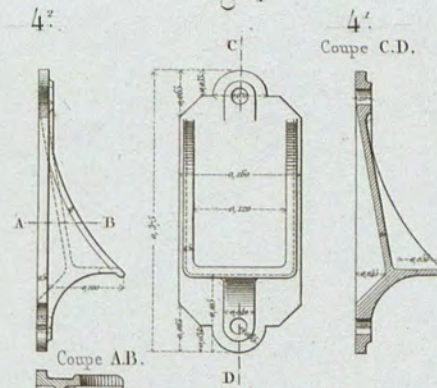

Fig. 4.



Coupe A.B.

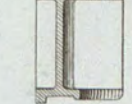
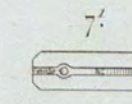
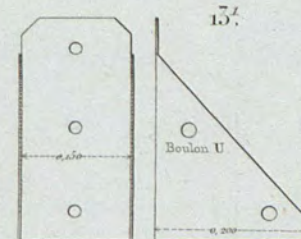

Fig. 7.



15<sup>z</sup>



15<sup>z</sup>

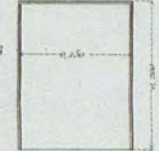

Détails des Grues mobiles.

Fig. 5.

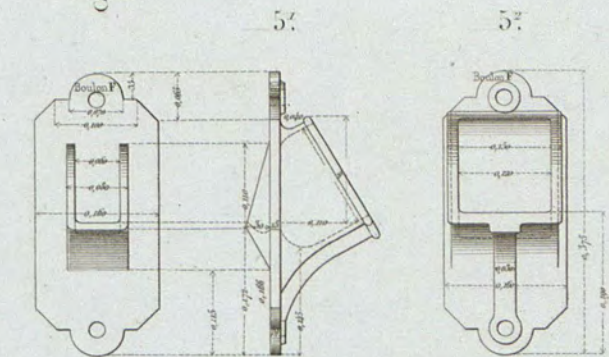

4<sup>z</sup> Coupe C.D.

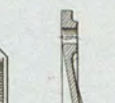

6<sup>z</sup>

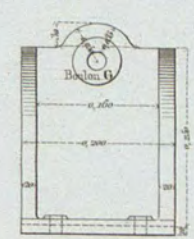

6<sup>z</sup>

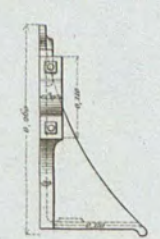
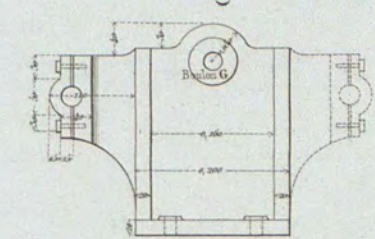

Fig. 6.



6<sup>z</sup>

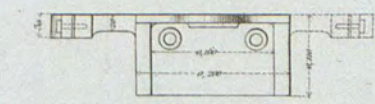

Fig. 13.

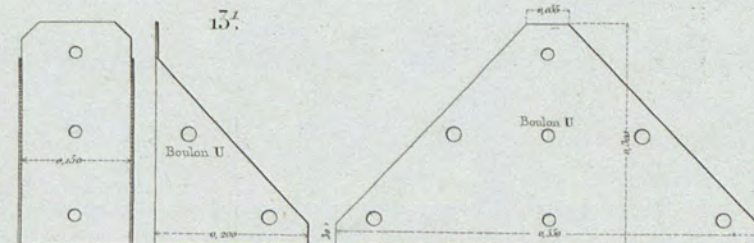

Fig. 15. Boulons

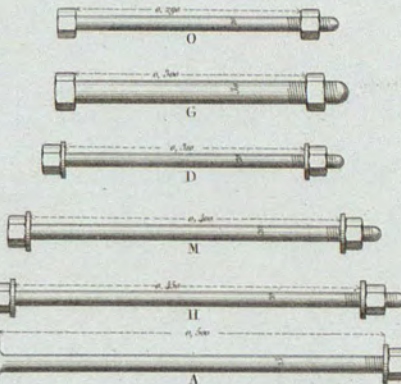

Fig. 16. Boulons

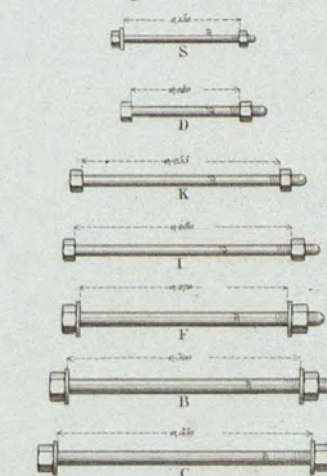
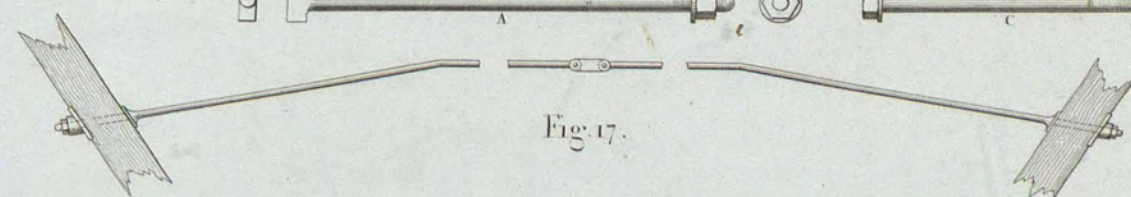

Fig. 17.



Echelle des trucs, caisses à mortier et à moellons 0<sup>m</sup> 04.

Détails des ferrures des grues mobiles 0<sup>m</sup> 10.

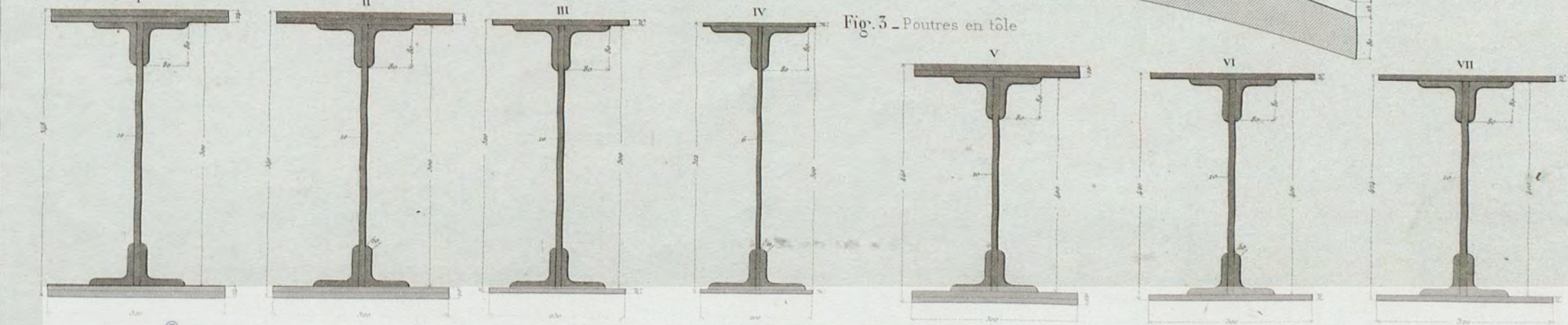
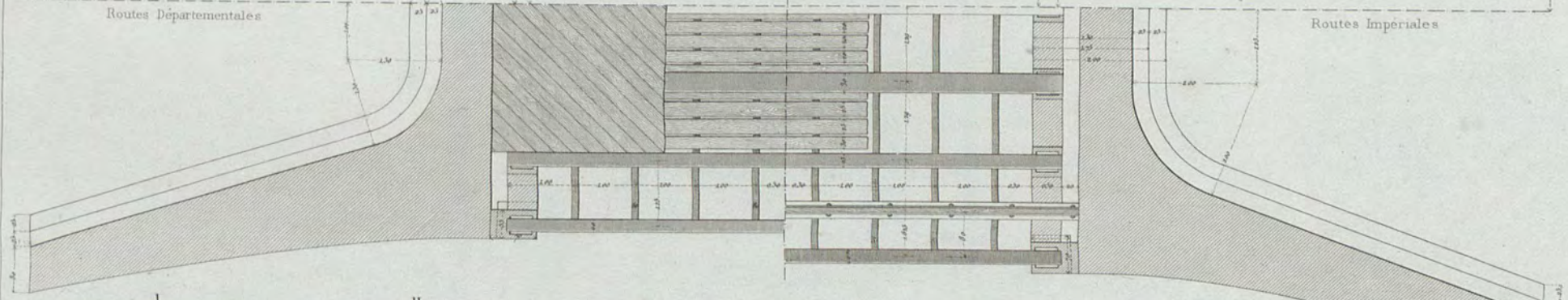
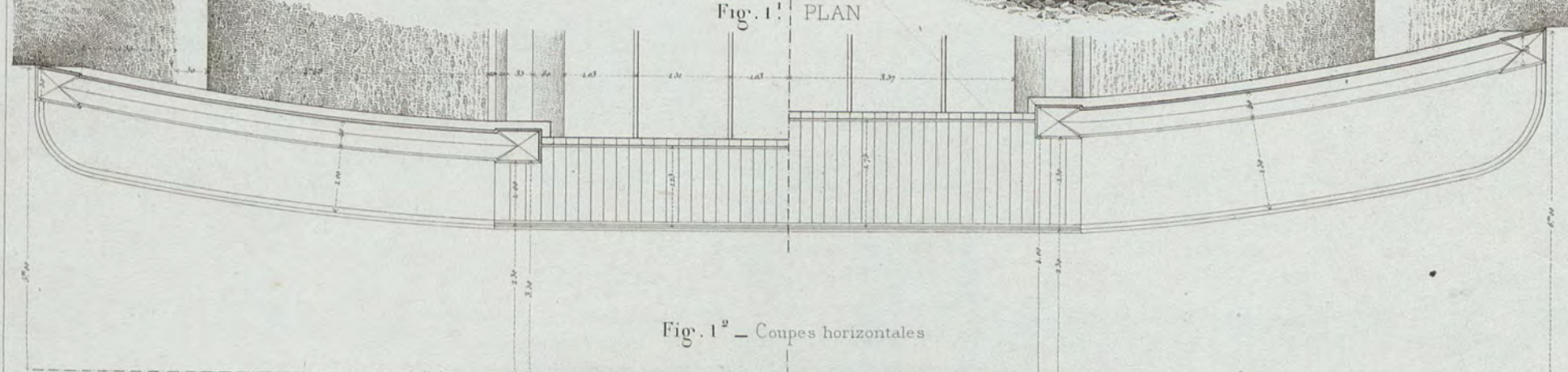
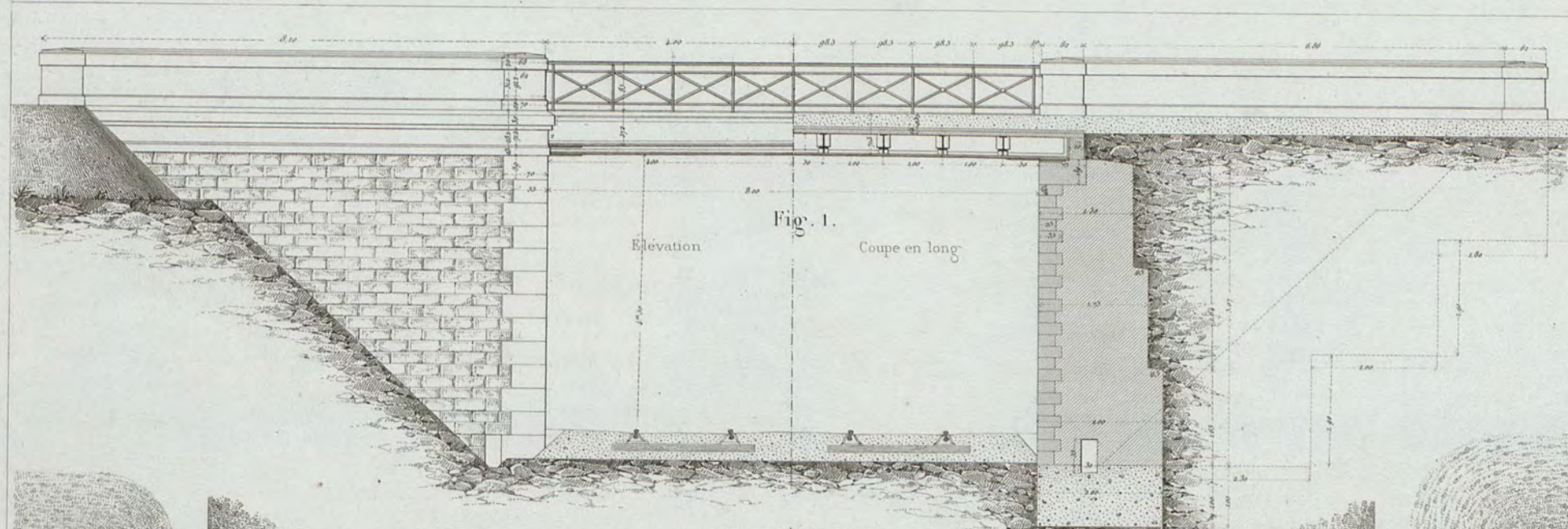

Fig. 2.1 - Coupe en long sur AB

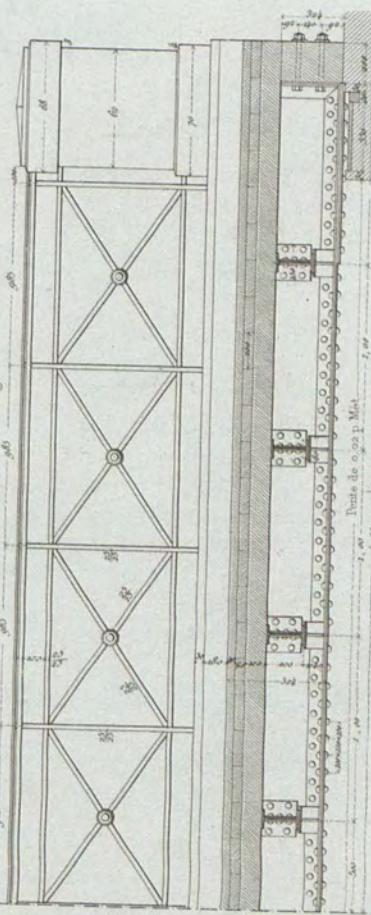
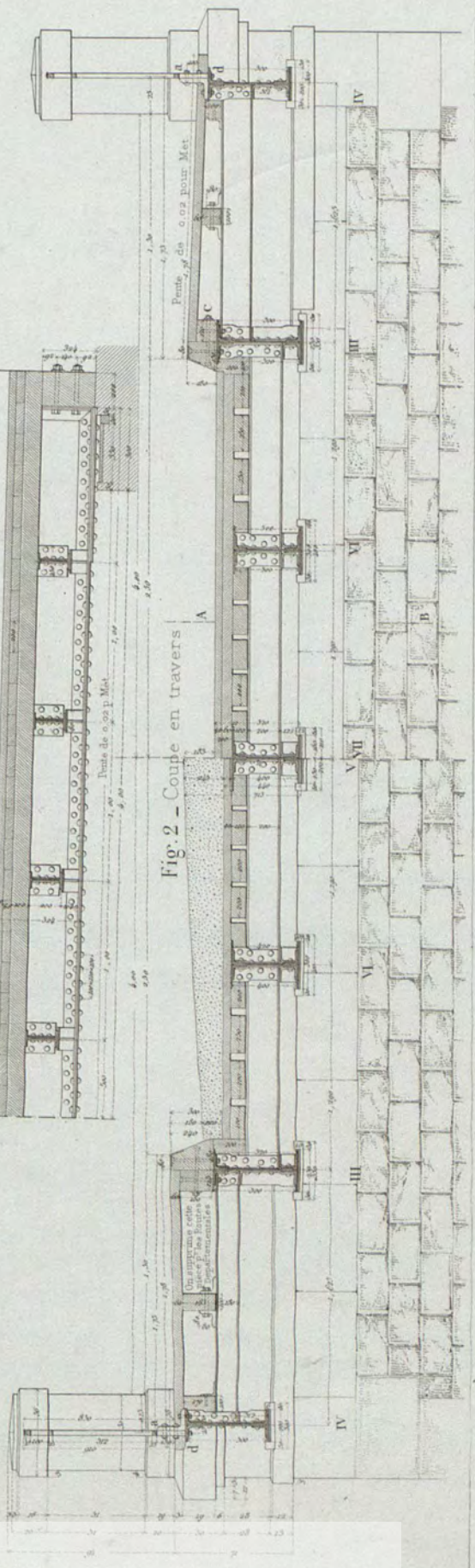
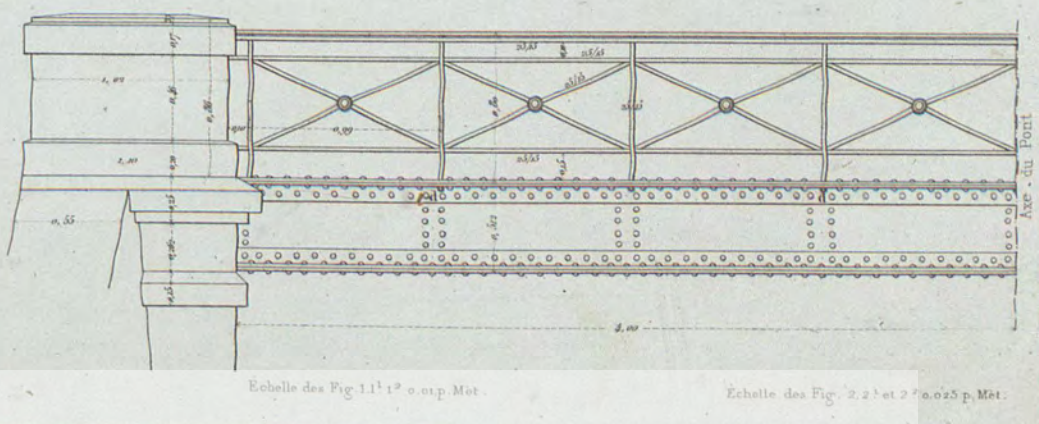
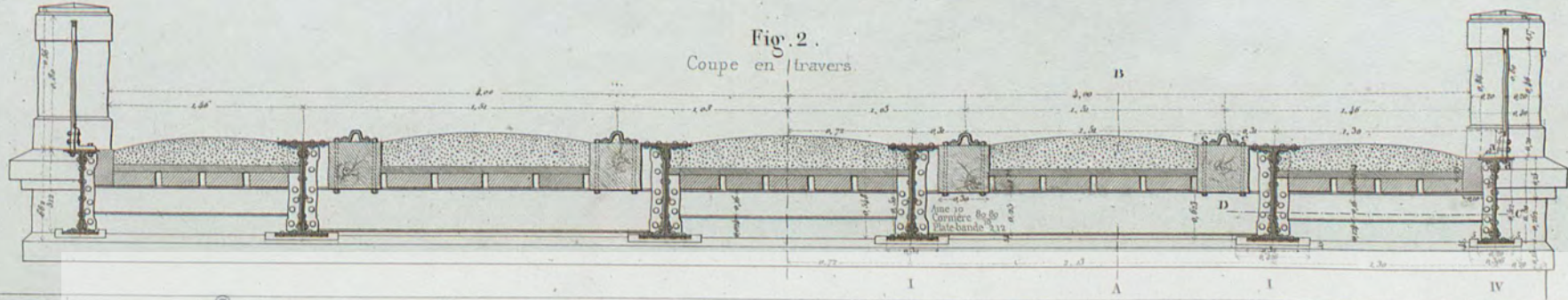
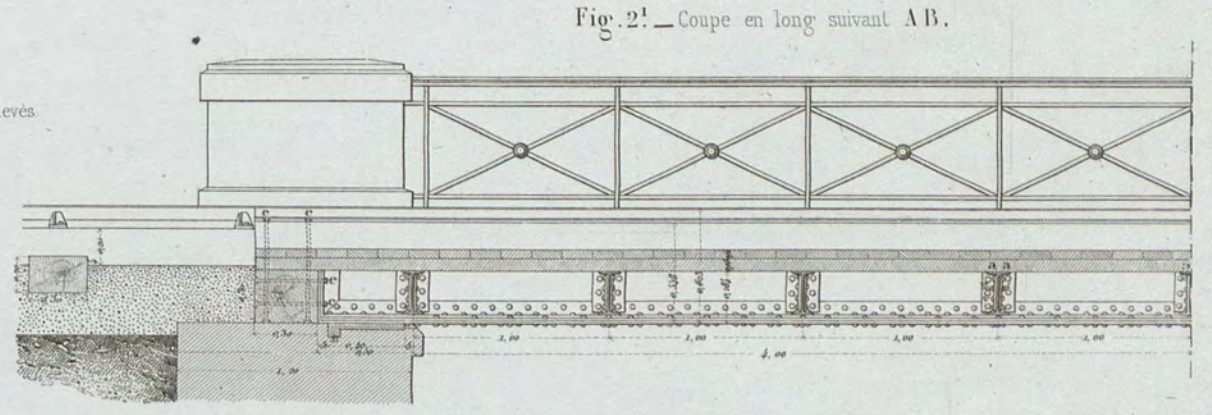
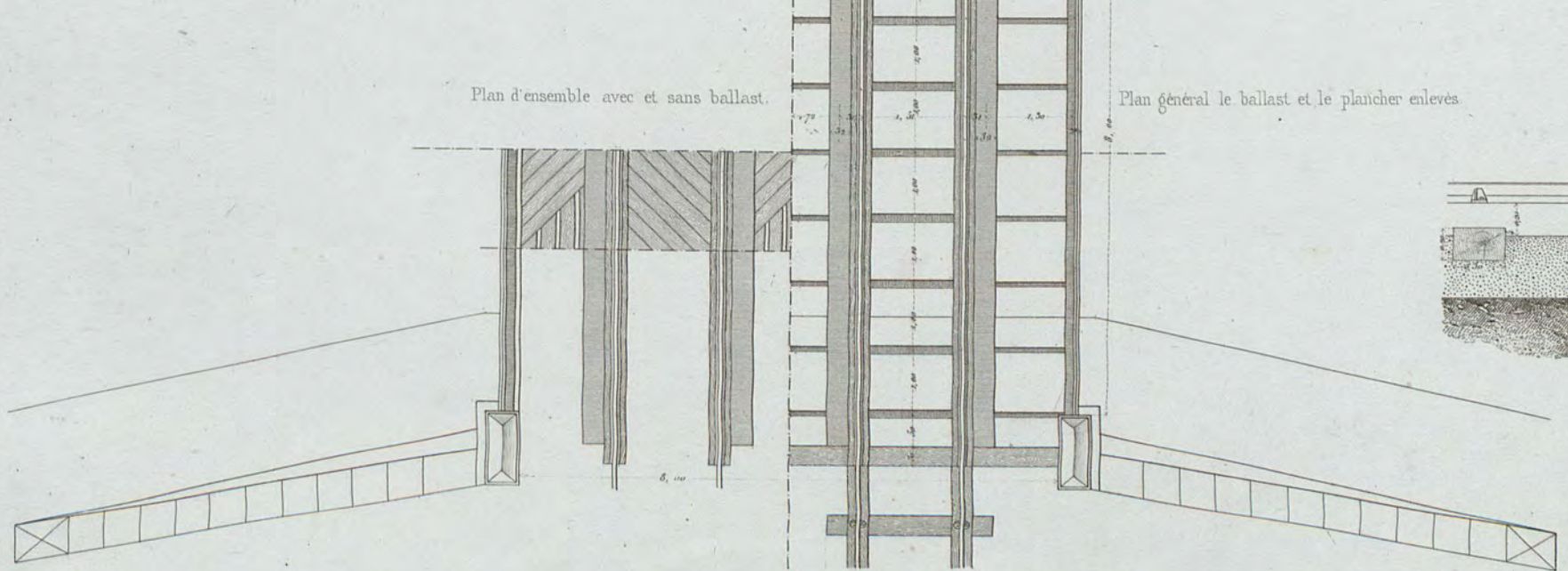
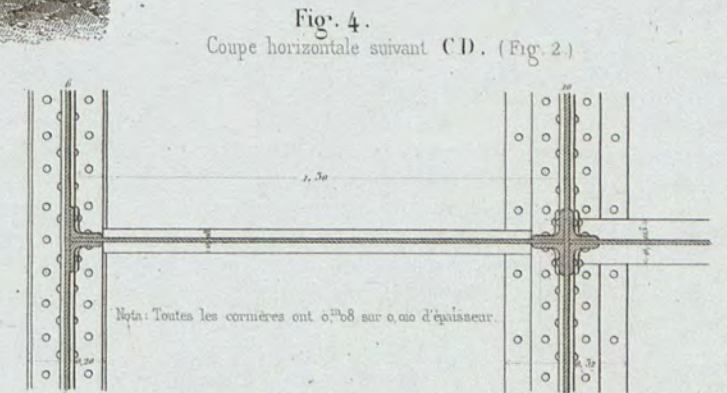
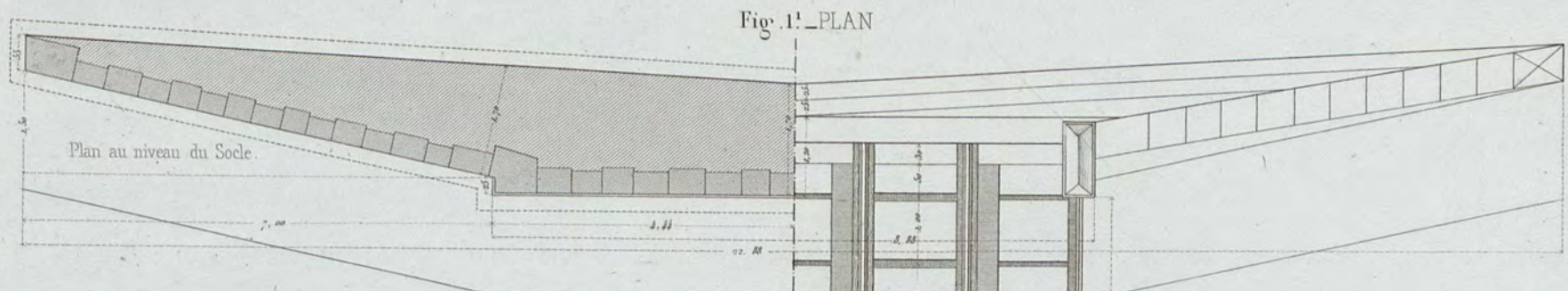
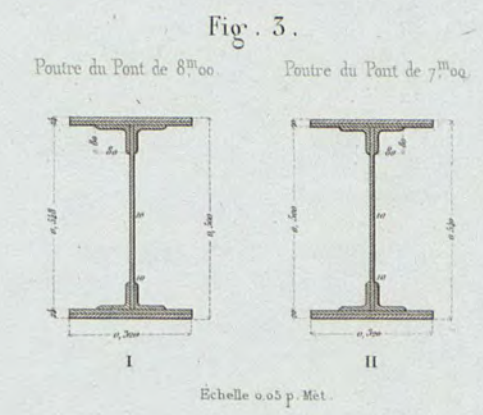
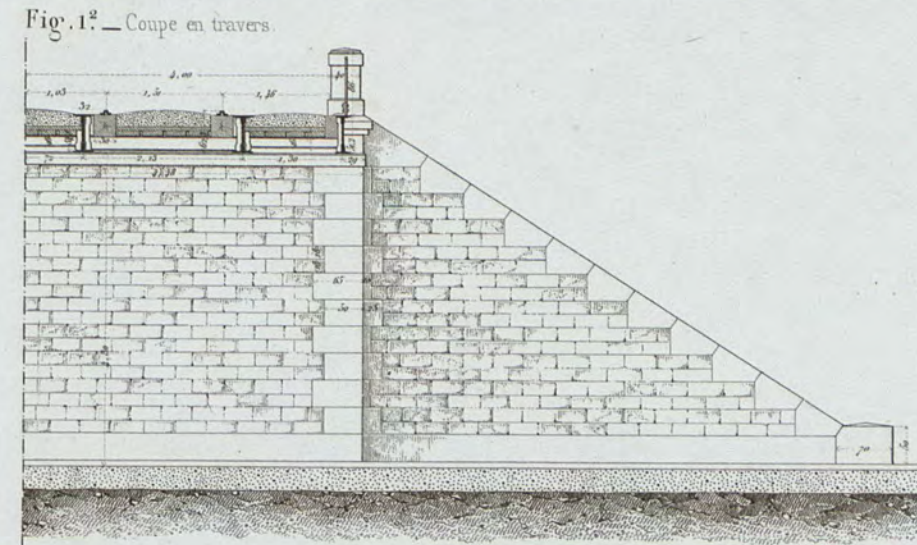
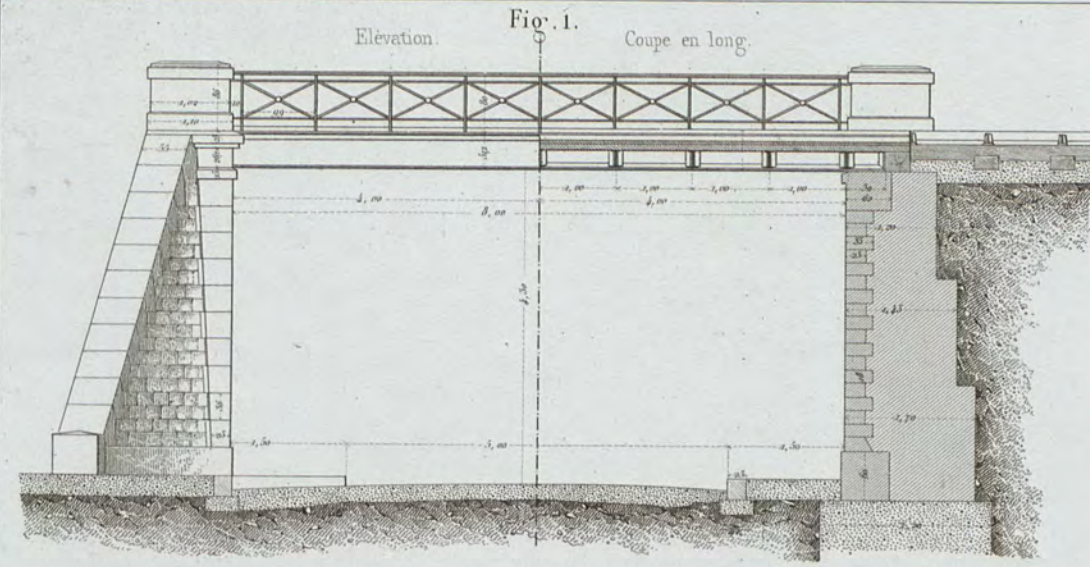
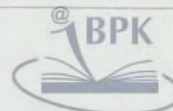

Fig. 2 - Coupe en travers





A. Jacquin direct.



L. Guiguet del et Sc.

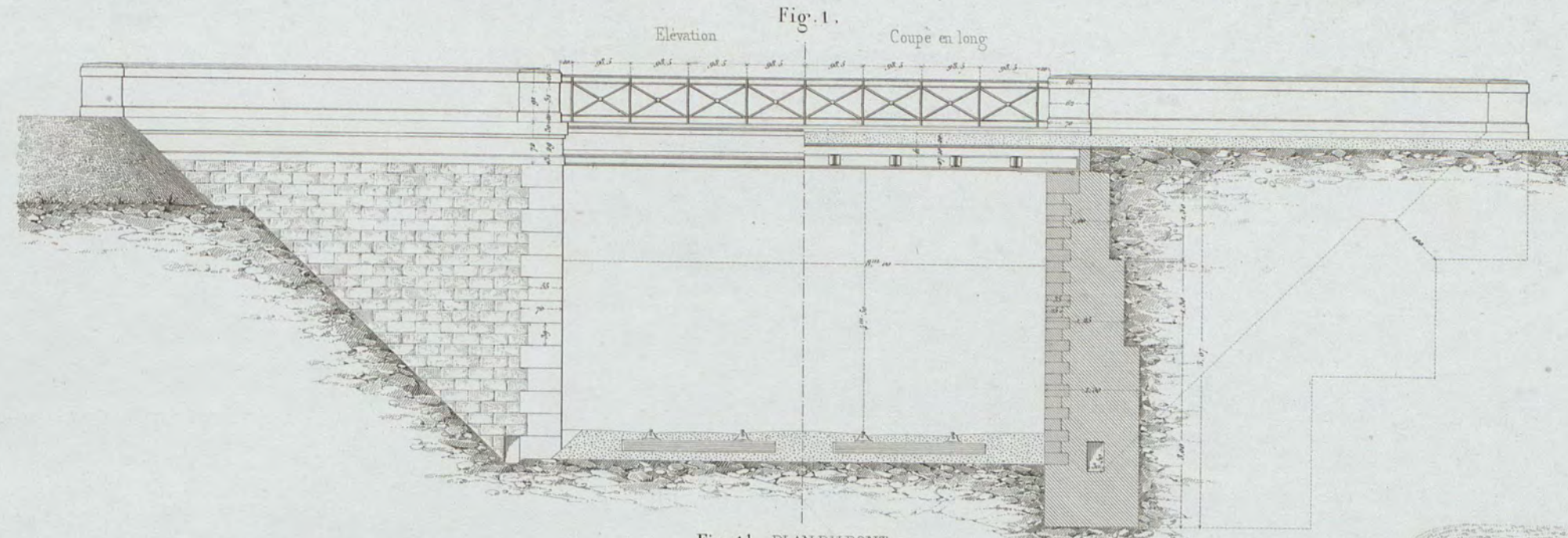

Fig. 1! - PLAN DU PONT

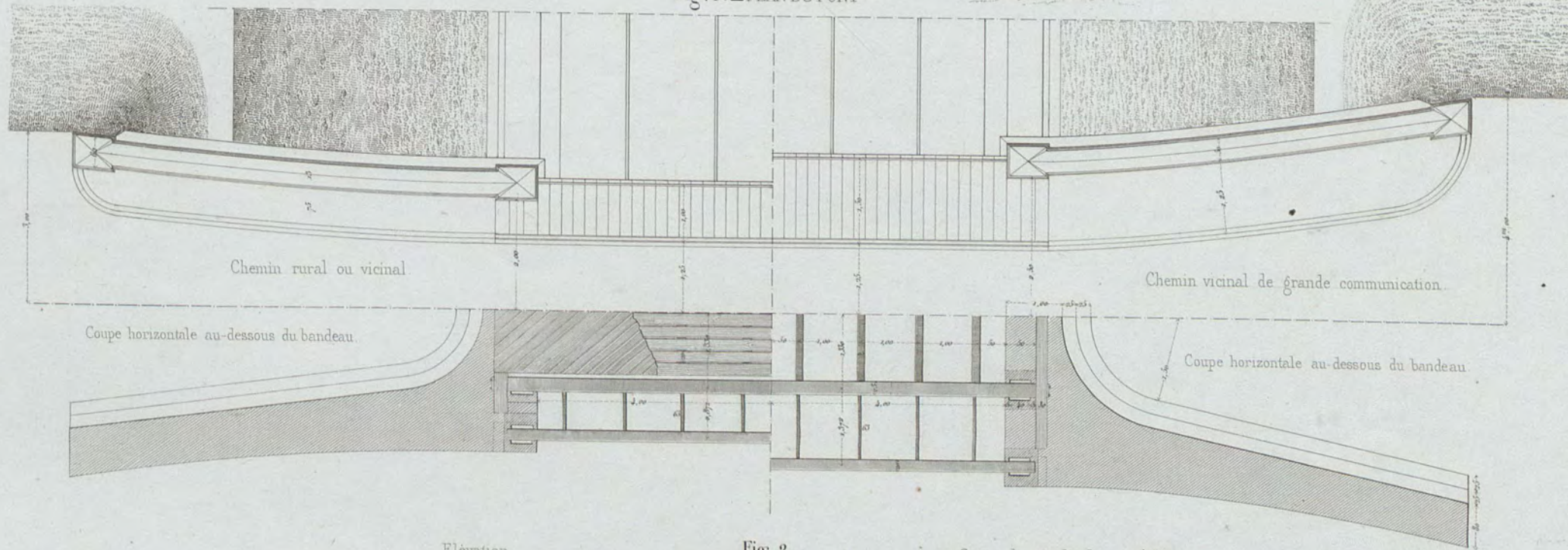
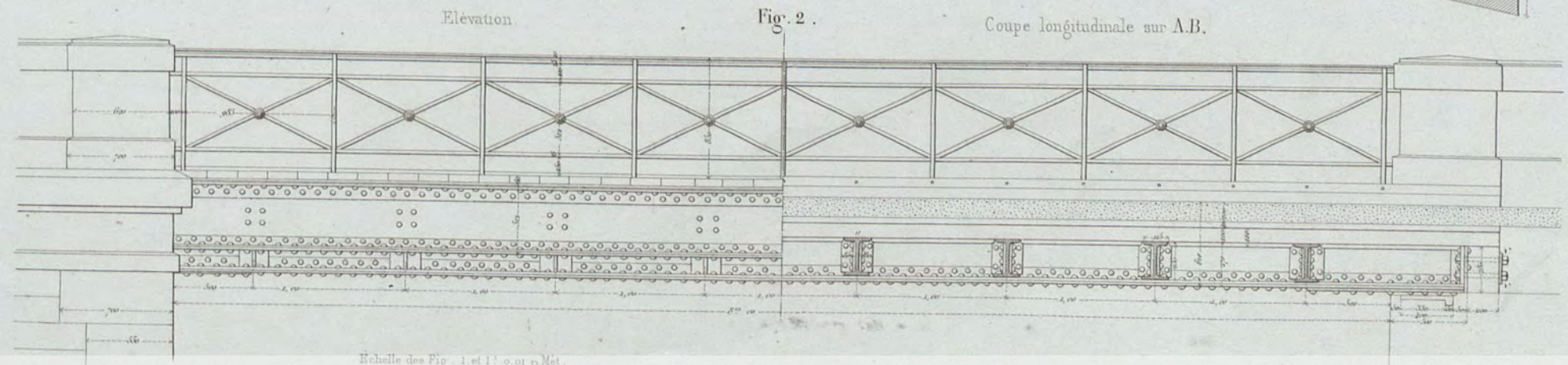
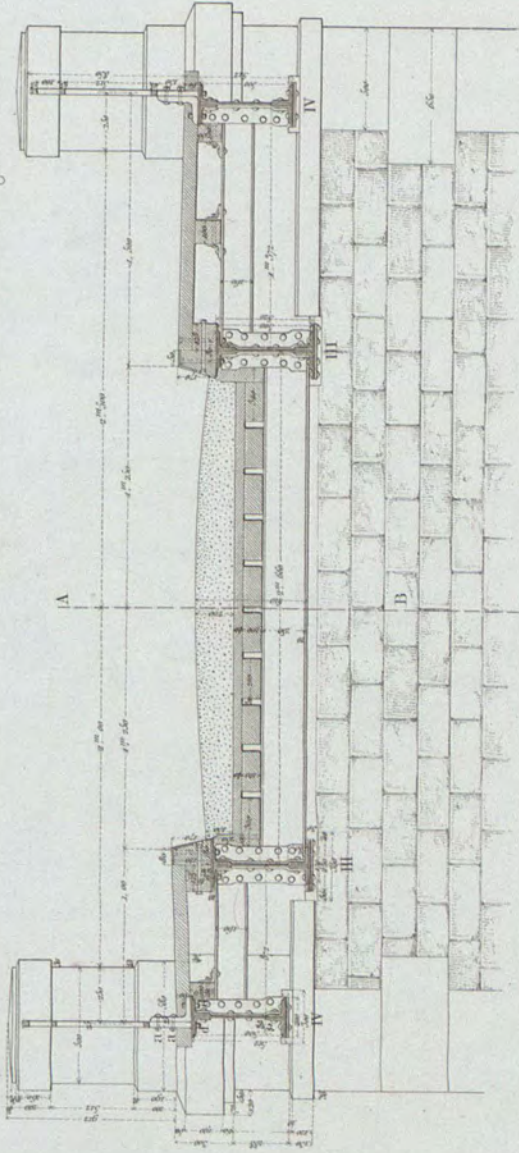

Fig. 2!

Coupe transversale d'un Pont pour chemin vicinal de grande communication.



Echelle des Fig. 1 et 1! 1/200 p.Met.

Echelle des Fig. 2 et 2! 1/200.

A. Jacquin direc.

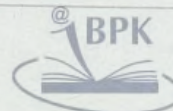

L. Guignot del. et sc.



Fig. 1 - Elevation - Coupe transversale.

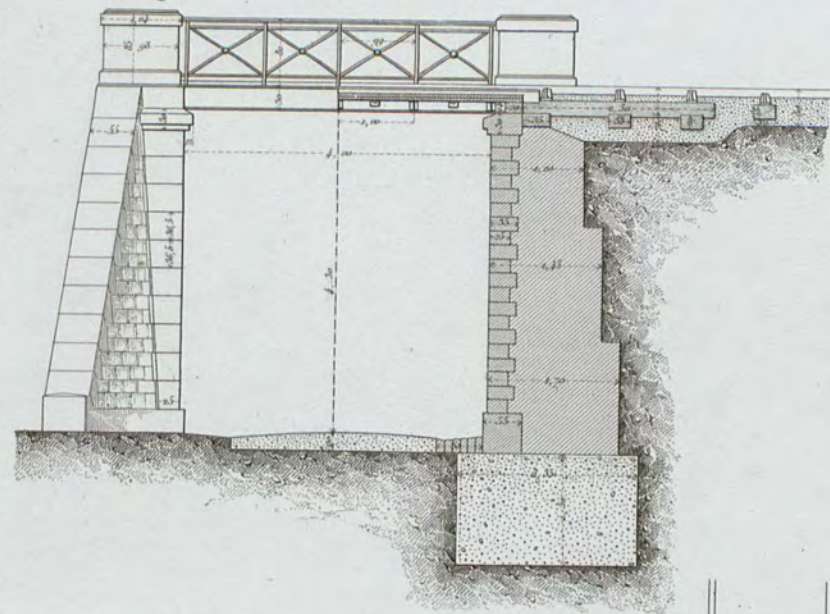

Fig. 1<sup>re</sup> - Coupe longitudinale A.B.C.

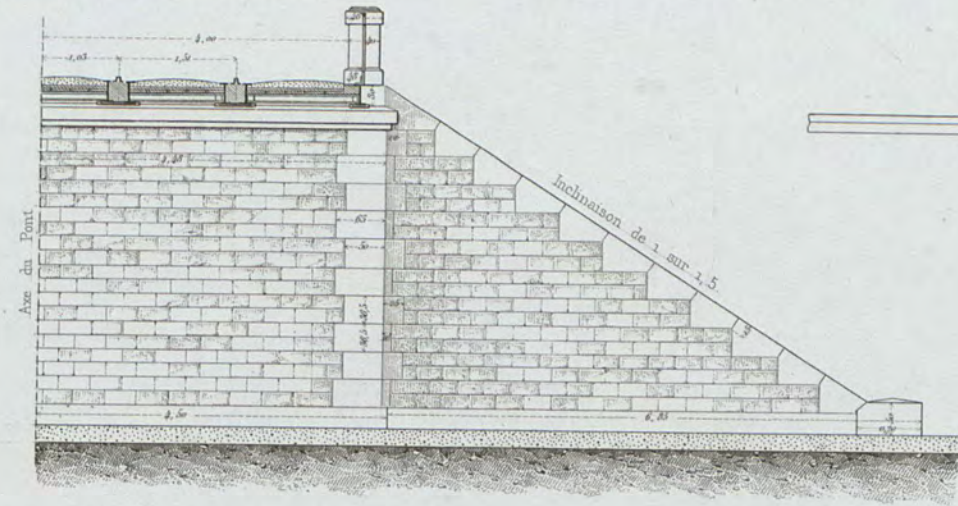
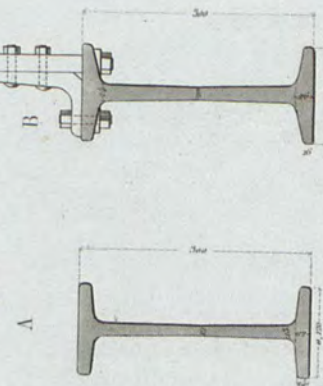

Fig. 4 - Détail des fers 1<sup>o</sup>



Notes: Pour les Ponts de 4<sup>m</sup> on emploie le fer A  
Pour les Ponts de 5<sup>m</sup> on emploie le fer B

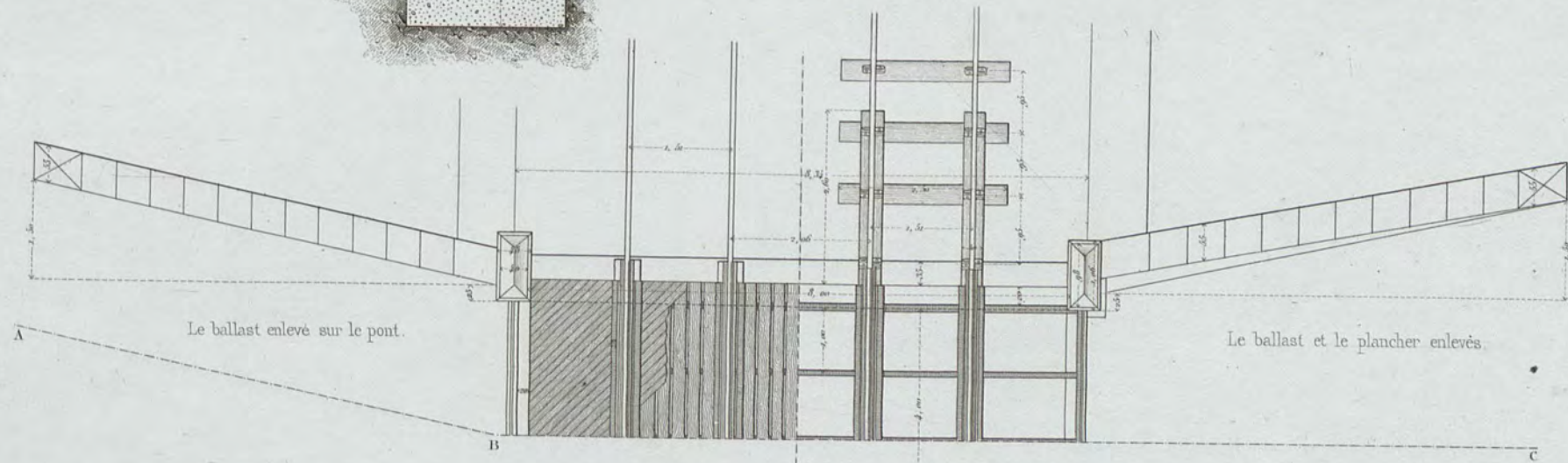

Fig. 1<sup>re</sup> - PLAN

Coupe horizontale au niveau du socle.

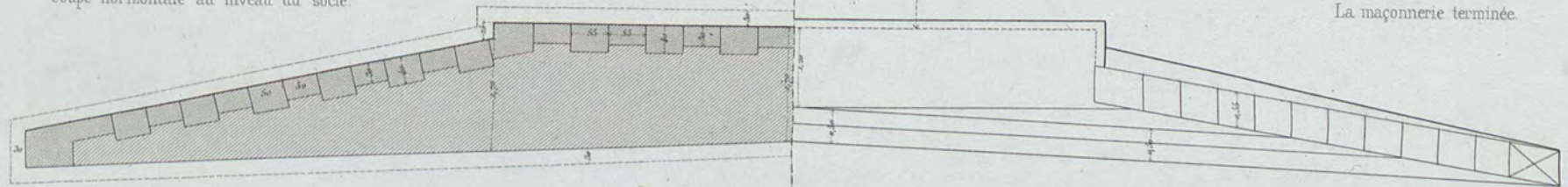

Fig. 2.

Coupe longitudinale

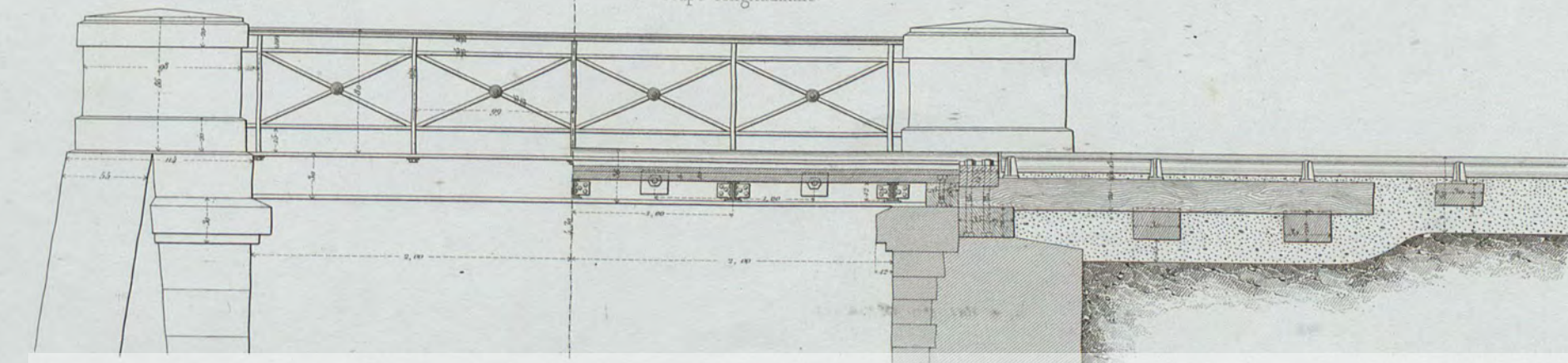

Fig. 3 - Coupe indiquant la réunion du rail du pont avec le rail de la voie.

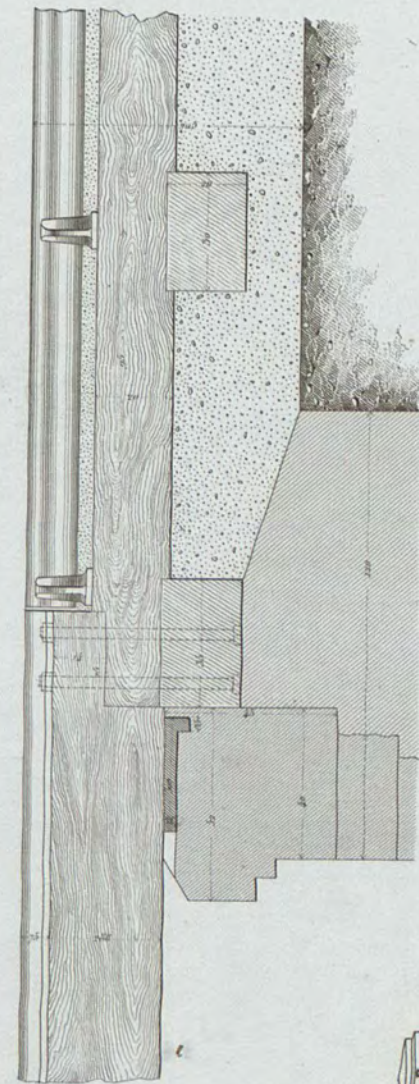

Fig. 2<sup>o</sup> - Coupe transversale

Echelle des Fig. 1<sup>re</sup> et 2<sup>o</sup> 0.01 pour Mét.

Echelle des Fig. 2<sup>o</sup> 0.025 p. Mét.

Echelle de la Fig. 3. 0.05

A. Jacquin direct.



Fig. 1<sup>r</sup> Suspension des poutres sur la pile centrale.

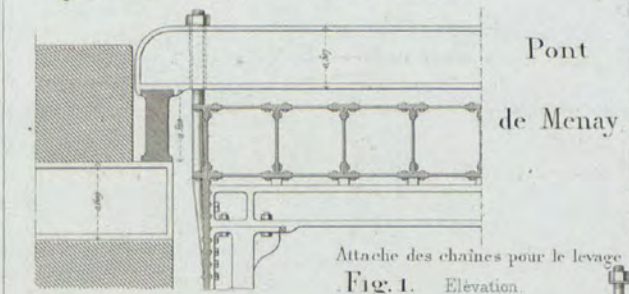
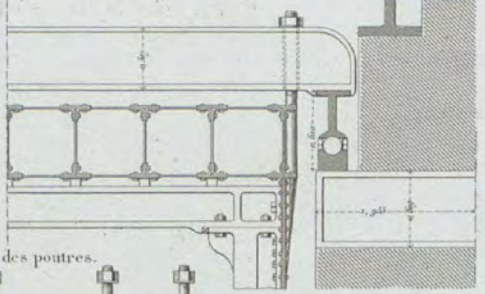

Fig. 1<sup>r</sup> Suspension des poutres sur les piles de rive.



Pont de Menay

Attache des chaînes pour le levage des poutres. Fig. 1. Elevation.

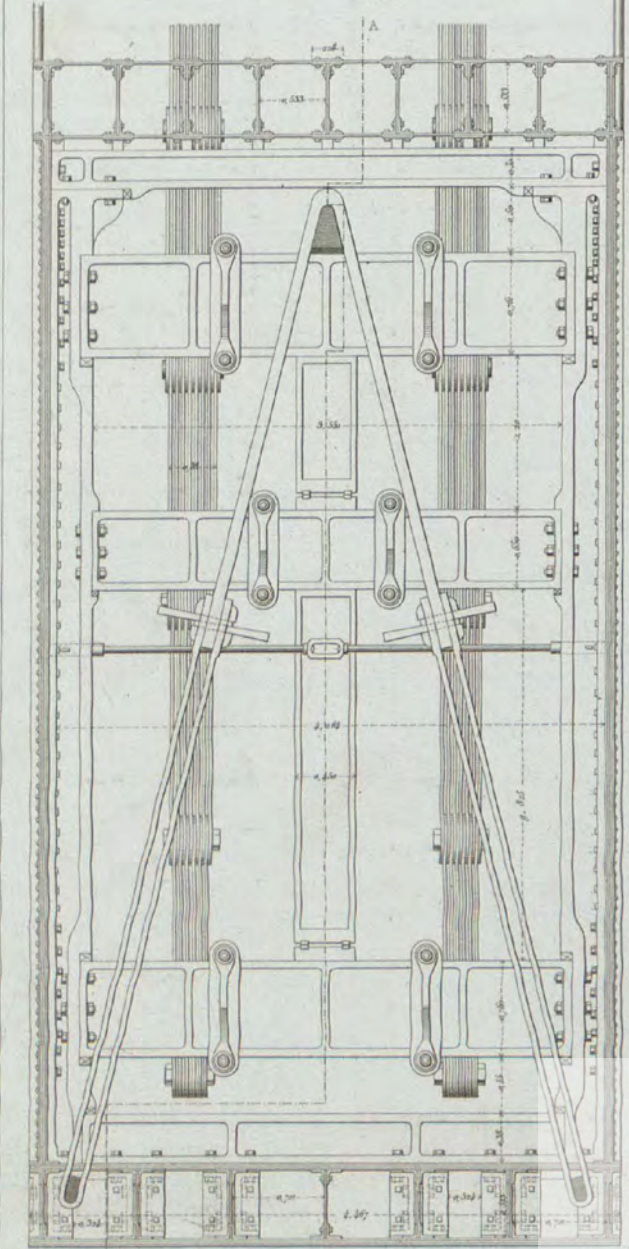
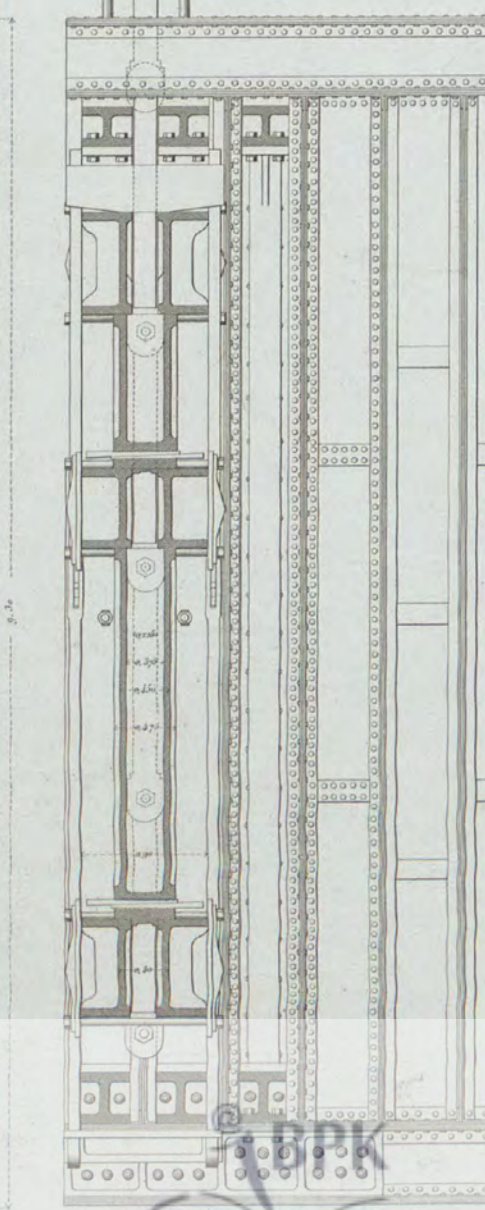

Fig. 1<sup>r</sup> Coupe AB.



Echelle 0,005 pour les Fig. 1 et 1<sup>r</sup>.

Fig. 1<sup>r</sup> Presse hydraulique employée pour le levage des poutres.

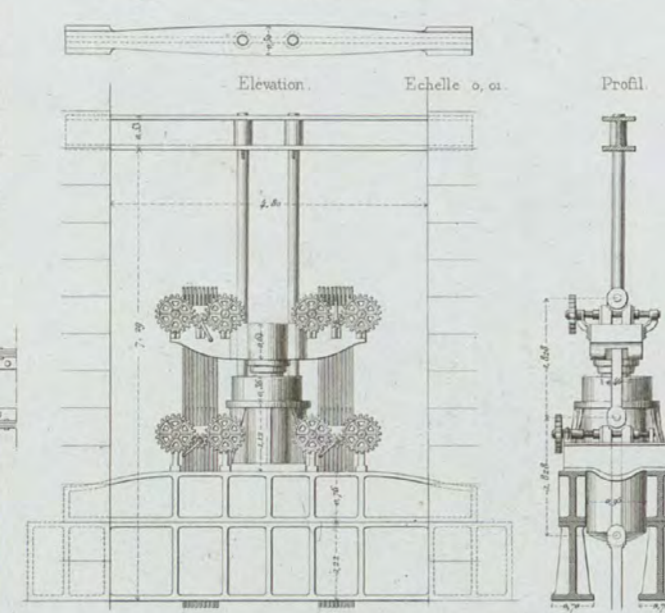
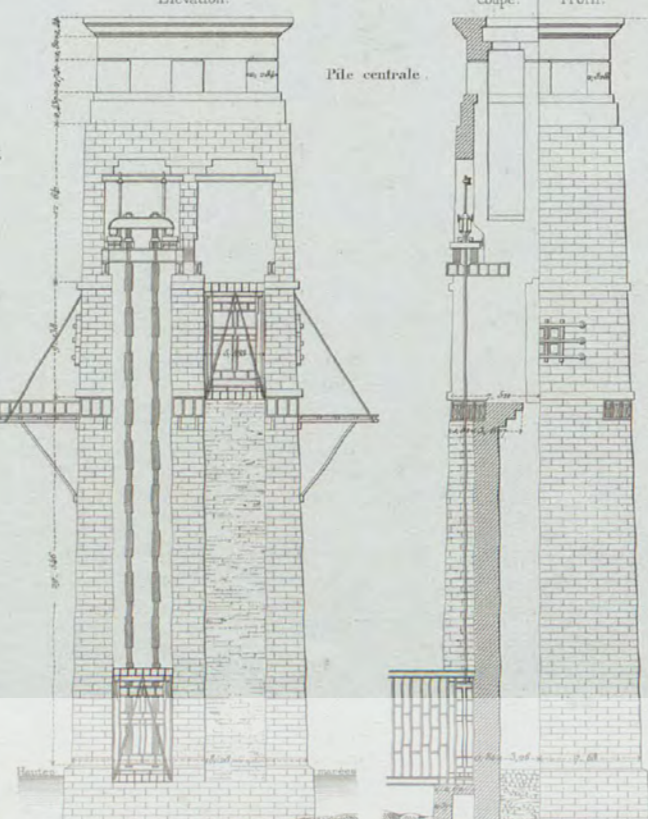

Fig. 1<sup>r</sup> Levage des poutres. Elevation. Coupe. Profil.



Pile centrale.

Echelle 0,005 pour les Fig. 1 et 1<sup>r</sup>.

Pont de Chepstow. Fig. 2. Coupe de la poutre inférieure et attache des chaînes de suspension.

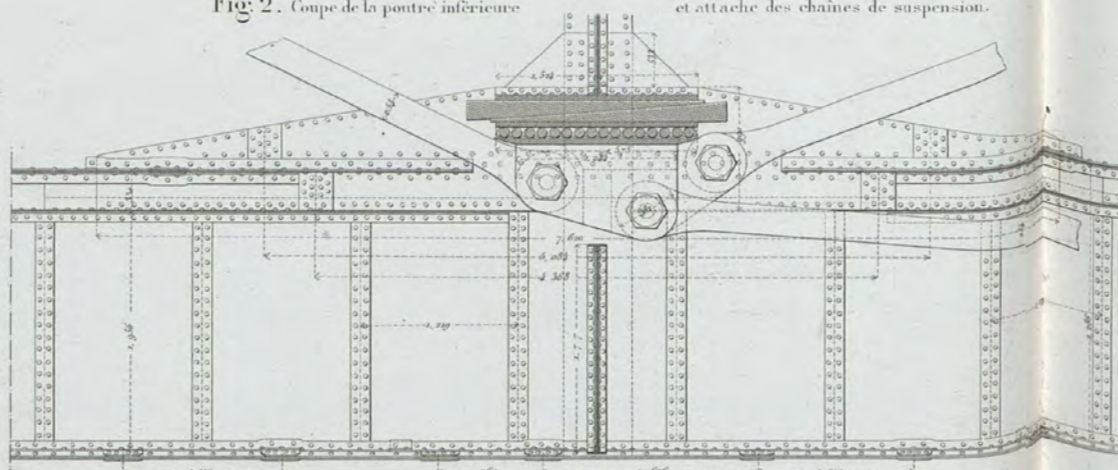

Fig. 2<sup>r</sup> Elevation de la poutre supérieure et attache des chaînes de suspension et des tirants verticaux.

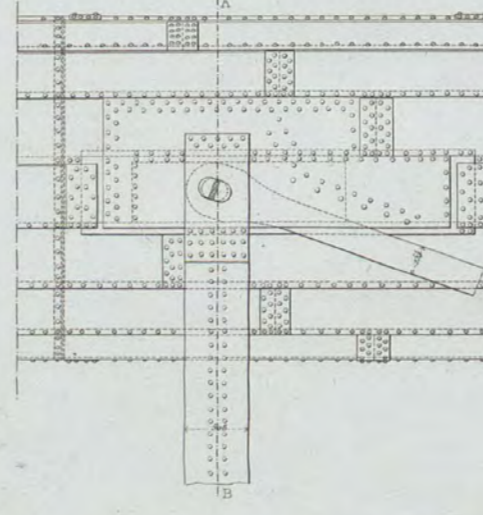

Fig. 2<sup>r</sup> Coupe de la poutre supérieure sur AB.

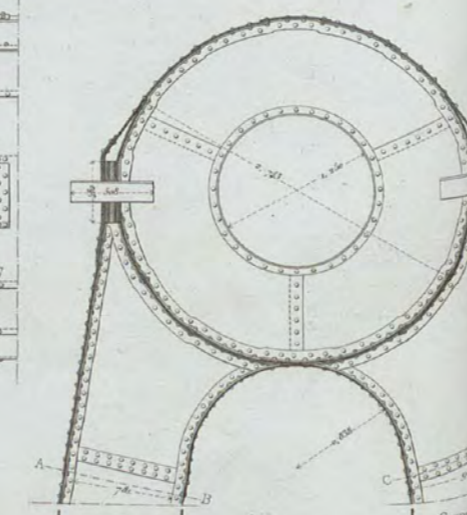

Fig. 2<sup>r</sup> Elevation de la poutre supérieure sur les piles.

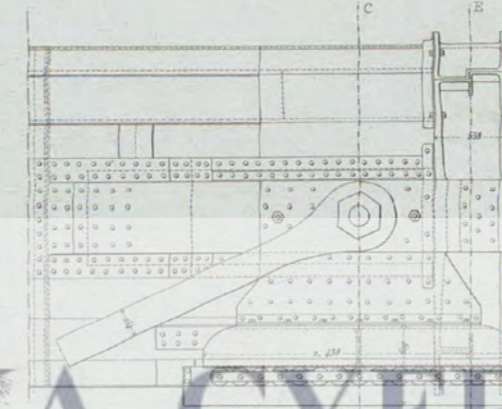

Fig. 2<sup>r</sup> Coupe E.F.

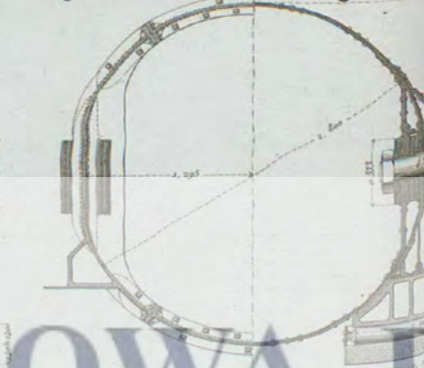

Fig. 2<sup>r</sup> Coupe C.D.



Fig. 3. Attache des tirants verticaux et des chaînes de suspension.

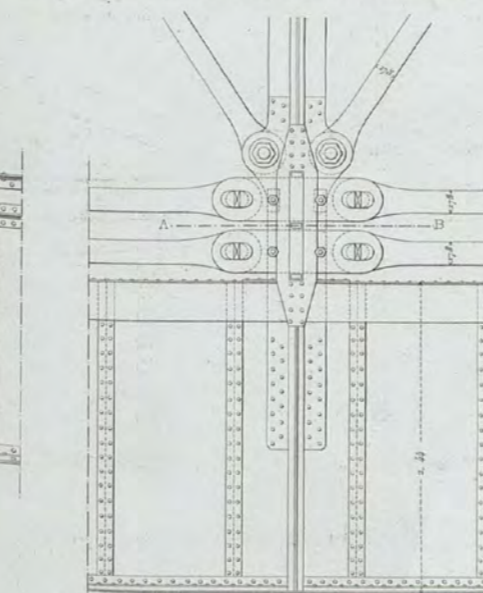

Fig. 3<sup>r</sup> Coupe suivant AB.



Fig. 3<sup>r</sup> Elevation des piles sur la terre ferme.

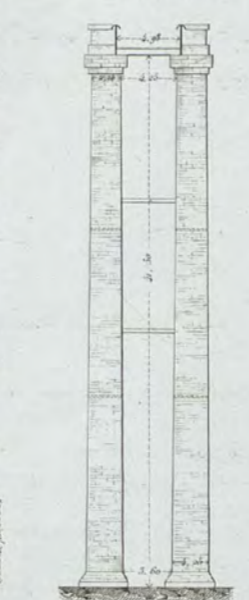

Fig. 3<sup>r</sup> Elevation de la pile centrale.

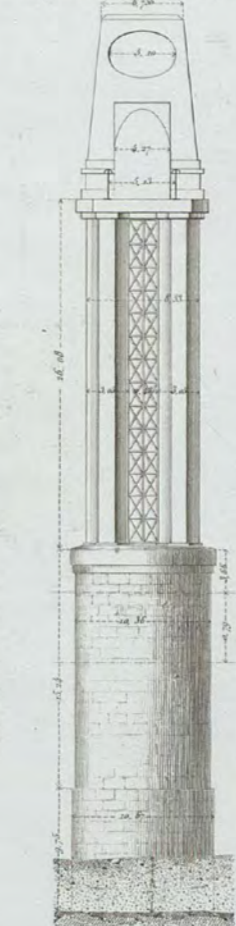

Fig. 3<sup>r</sup> Coupe de la poutre supérieure et des poutres inférieures.

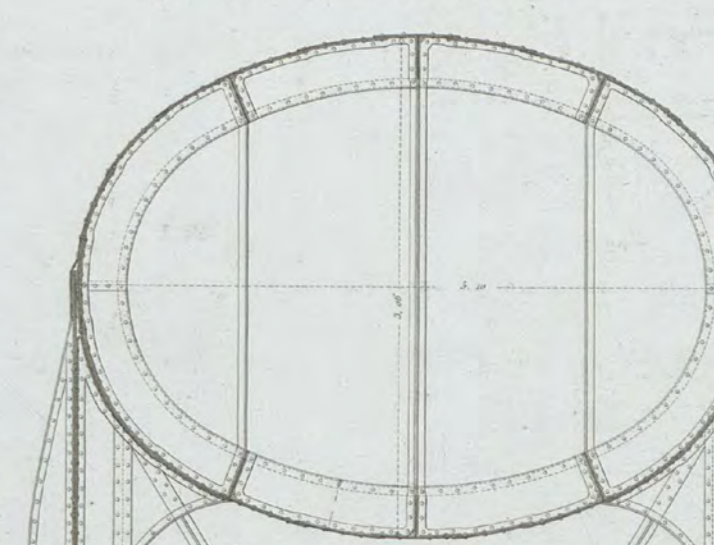
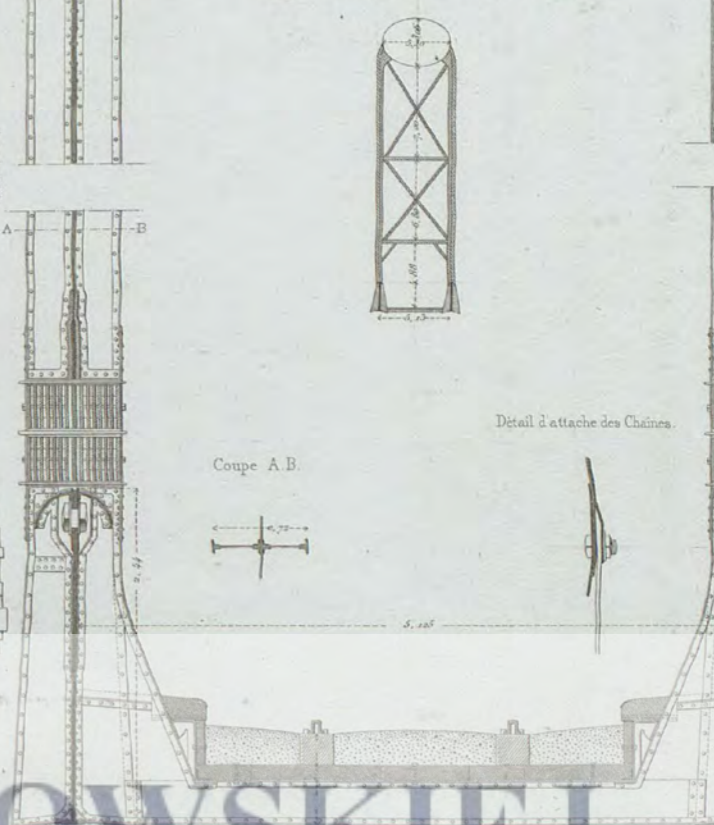

Fig. 3<sup>r</sup> Elevation d'une travée principale.



Coupe A.B.

Détail d'attache des chaînes.

Echelle 0,005 pour la Fig. 3.

Pont de Saltash.

Fig. 3<sup>r</sup> Détail du cylindre en tôle pour la fondation de la pile du milieu.

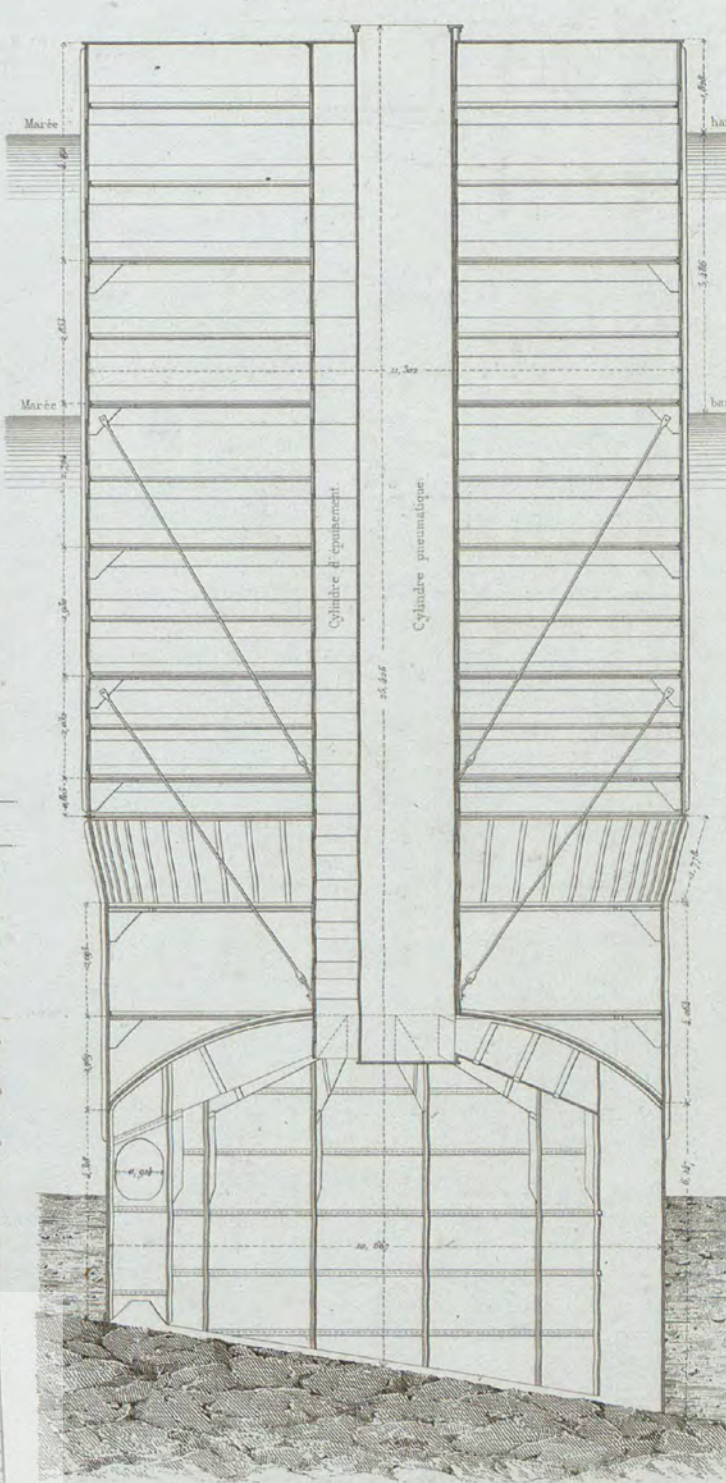

Echelle 0,005 pour la Fig. 3.

BIBLIOTEKA CYFROWA POLITECHNIKI KRAKOWSKIEJ

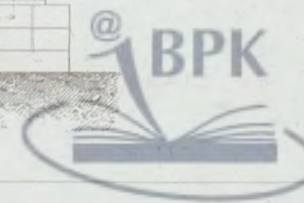
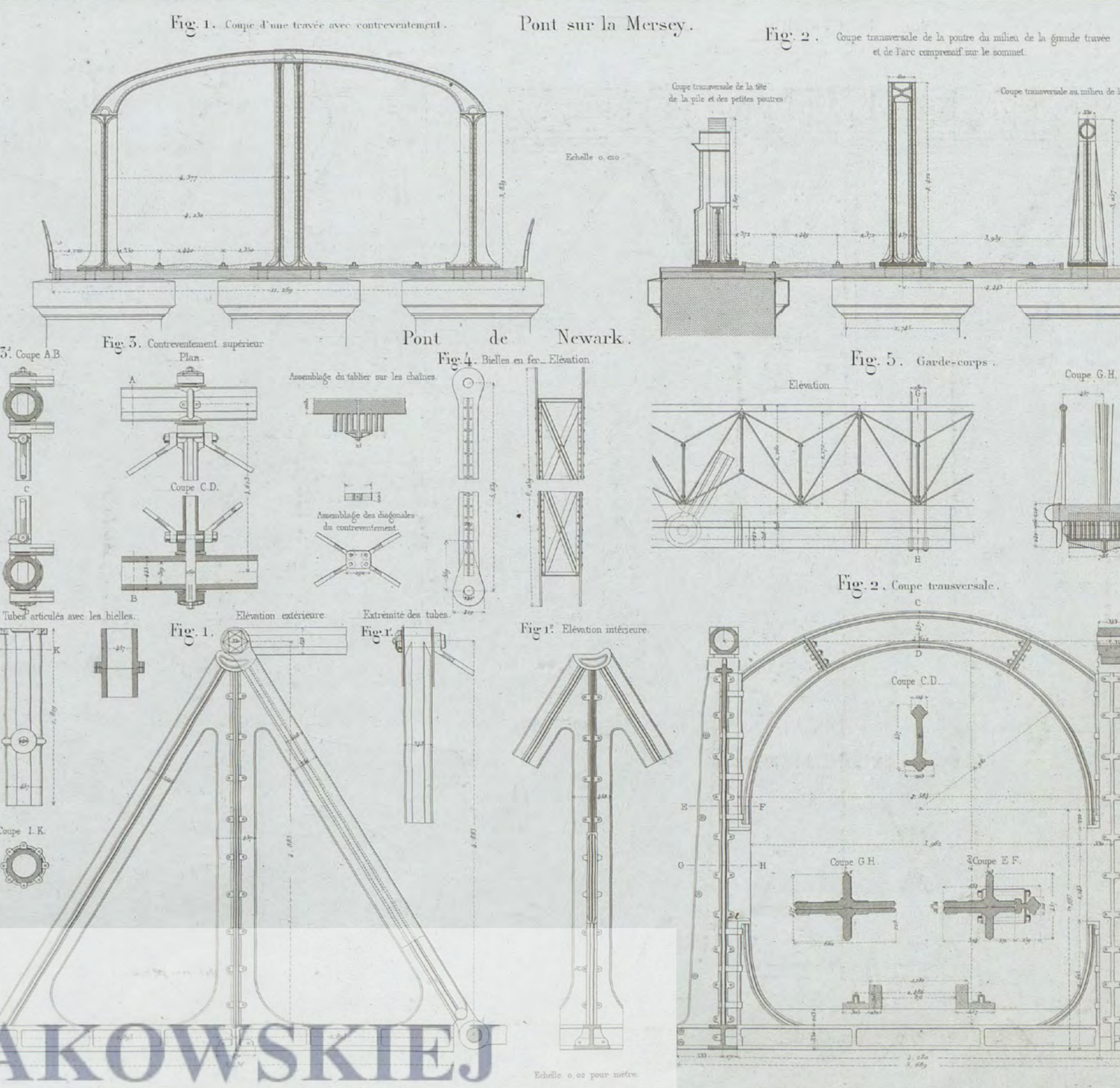
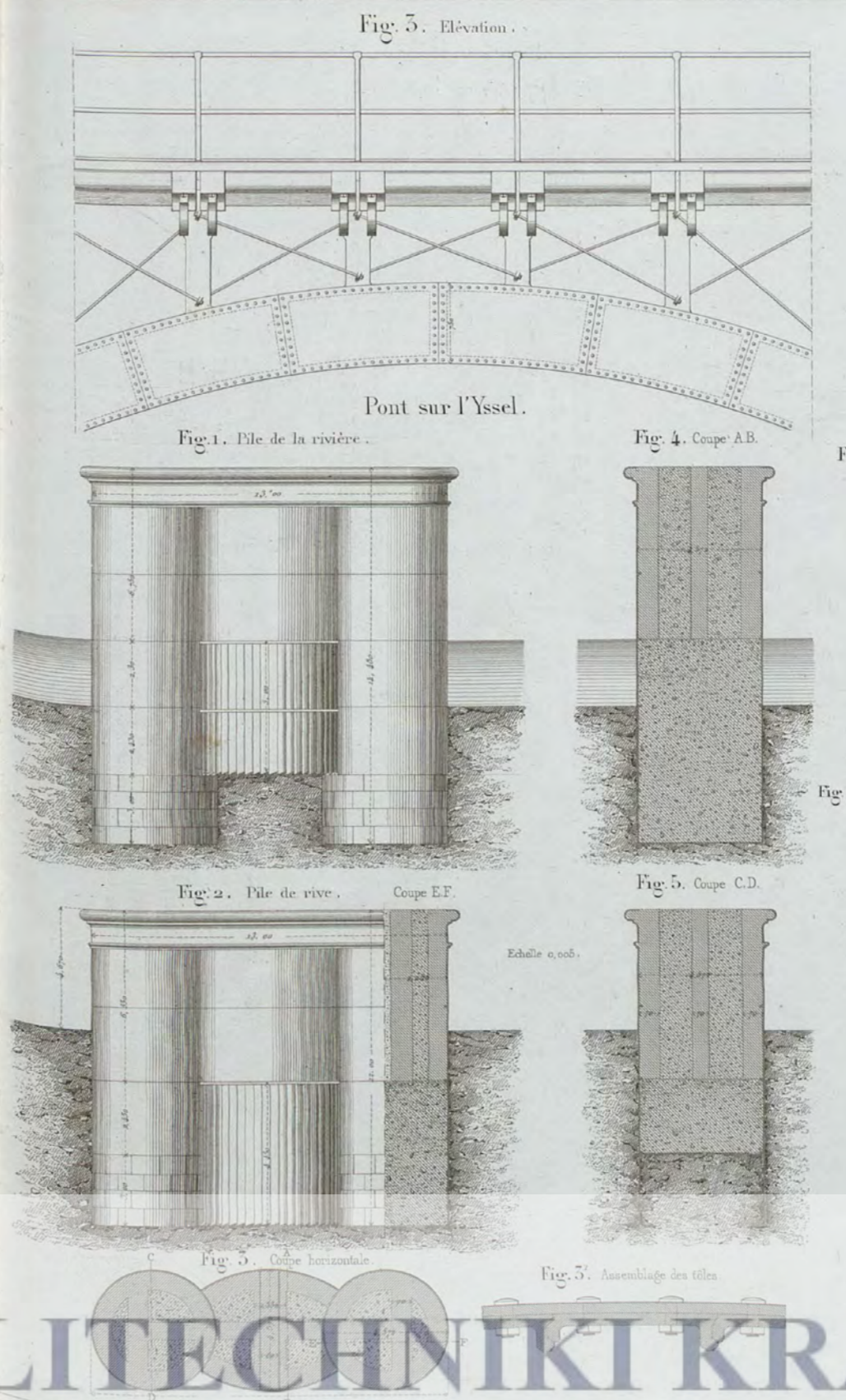
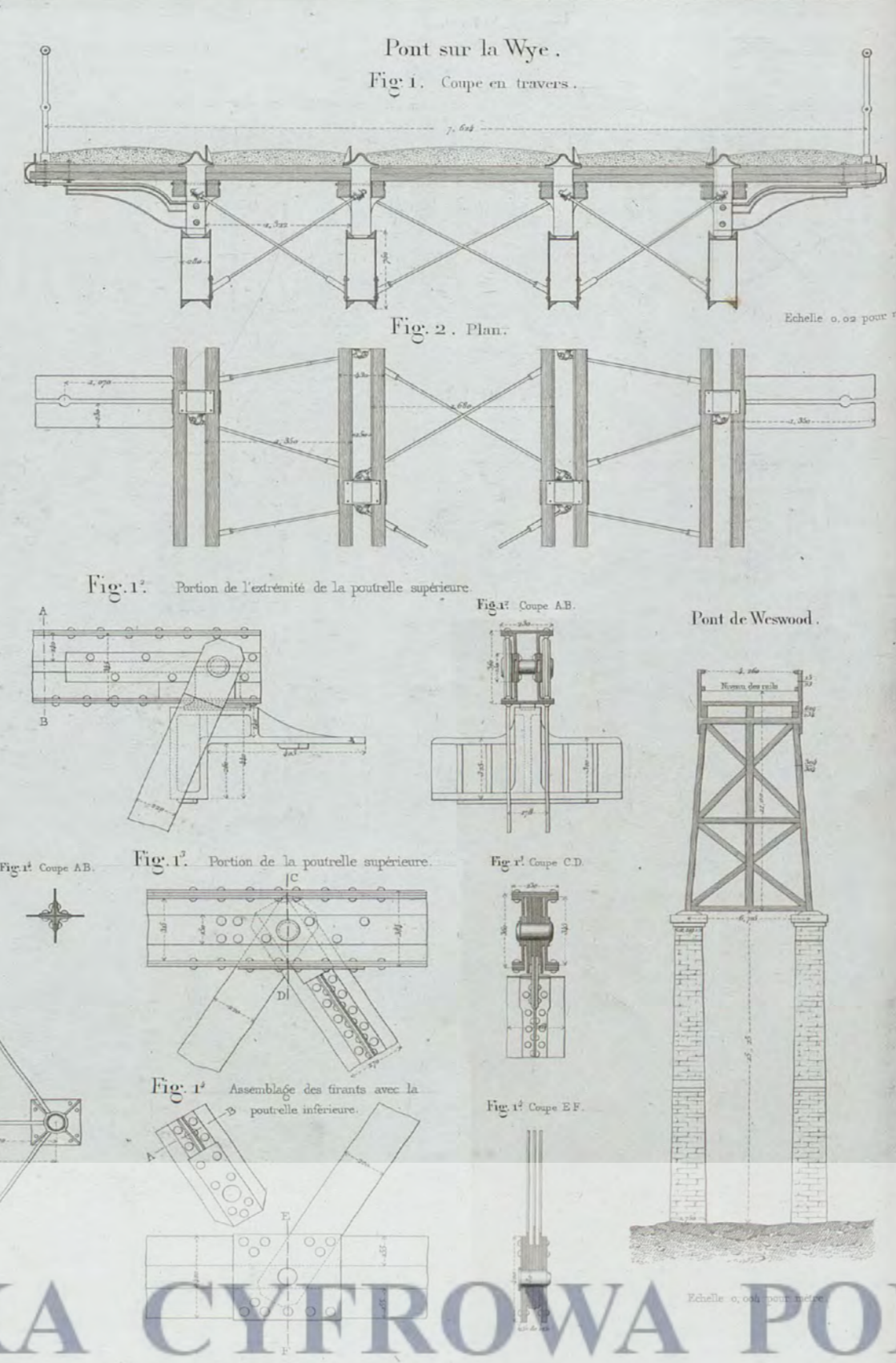
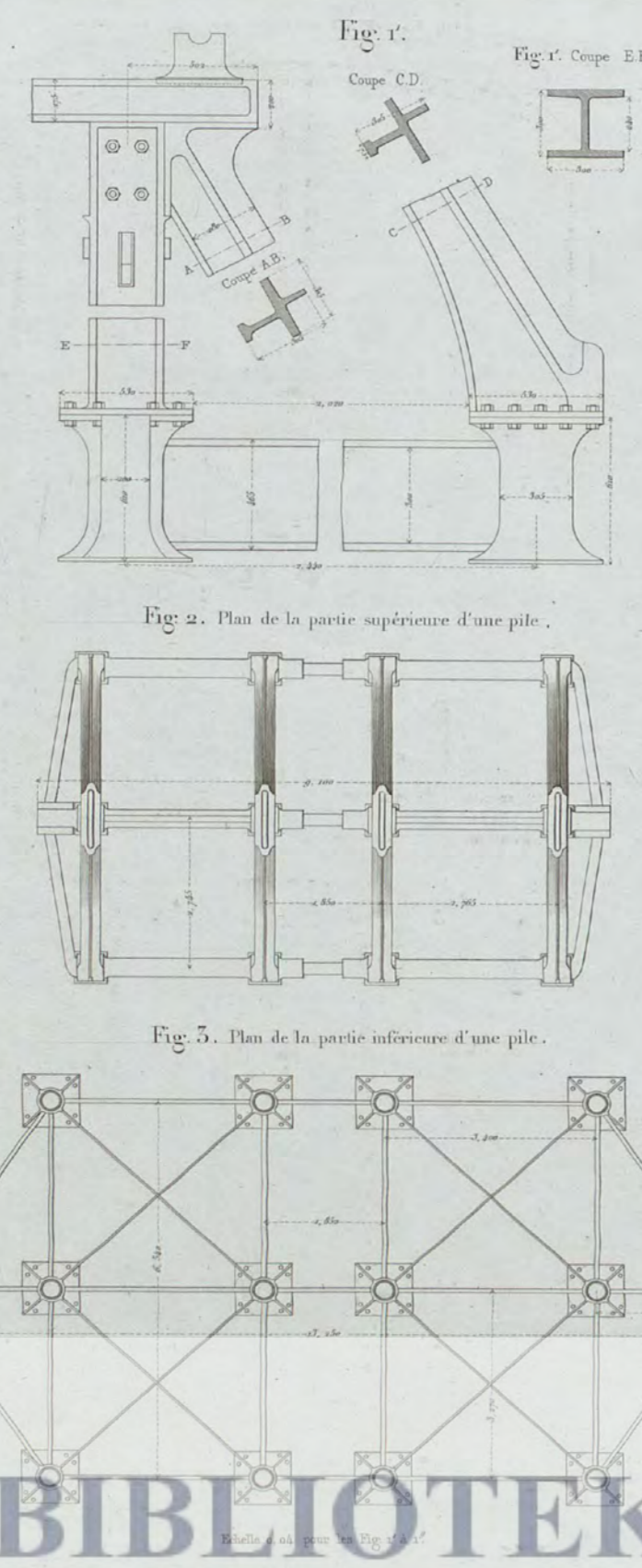
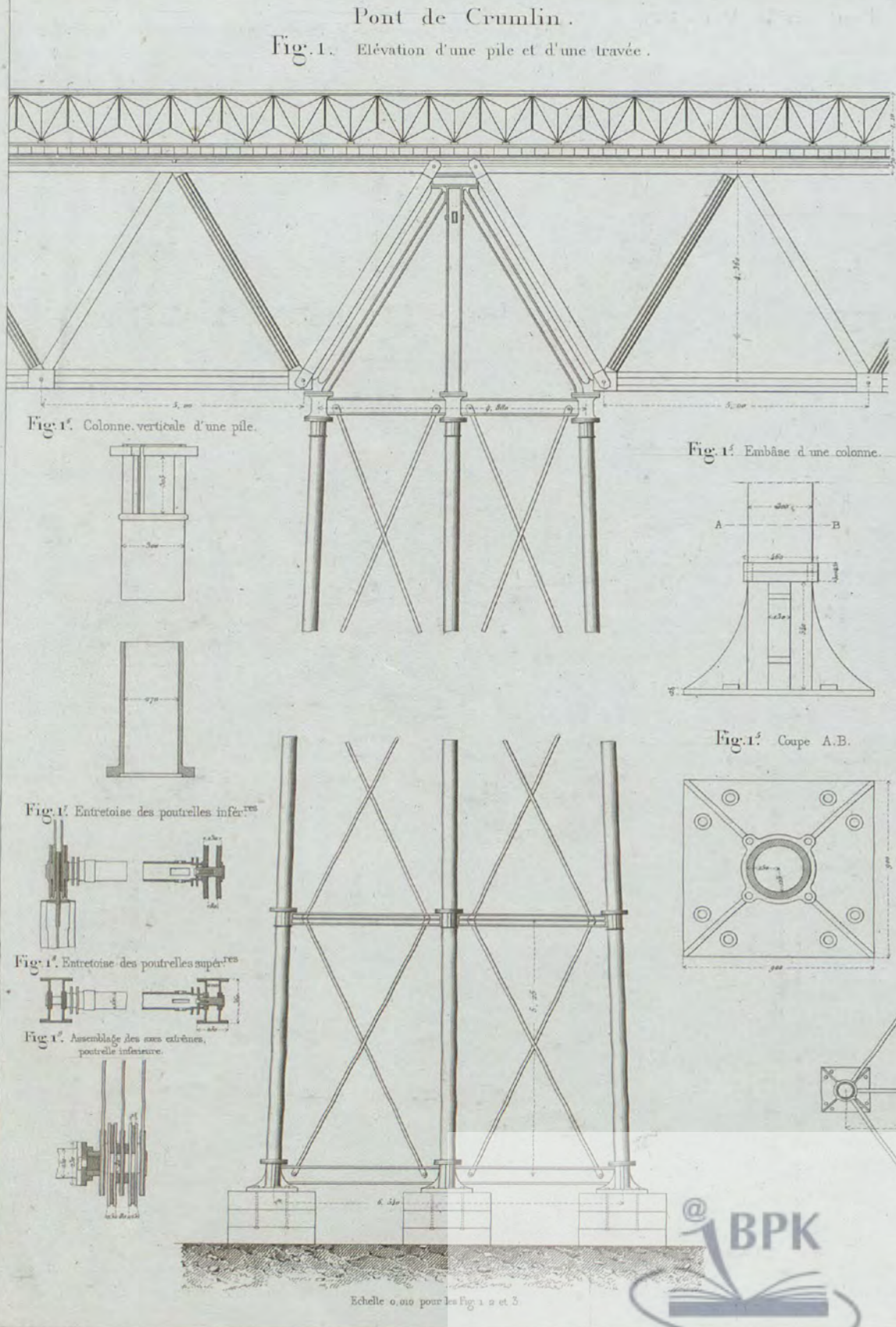

Fig. 1. Viaduc de Nogent sur Marne

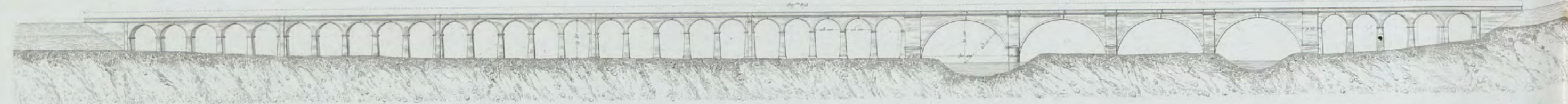

Fig. 2. Viaduc de l'Indre



Fig. 3. Viaduc de la Vouzie

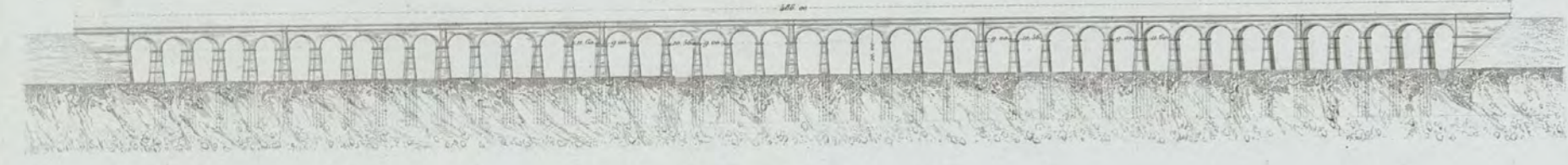

Fig. 4. Viaduc du Gœtzschthal

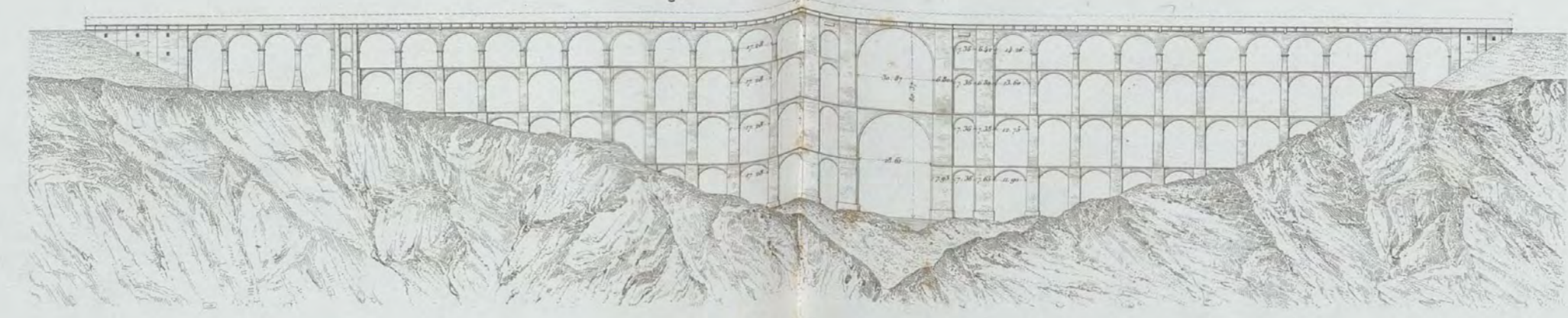

Fig. 5. Viaduc du Loing



Fig. 6. Viaduc de Gœrlitz

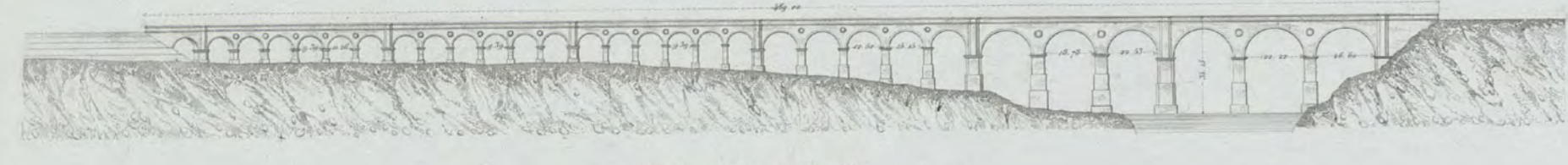

Fig. 7. Viaduc de la Largue



Fig. 8. Viaduc de Chantilly



Fig. 9. Viaduc de Chaumont

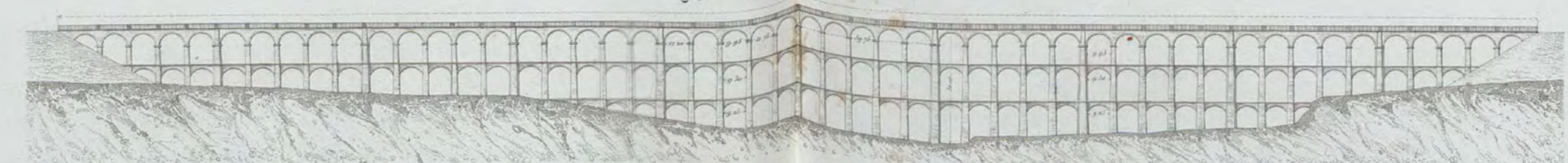

Fig. 10. Viaduc de Barantın



Fig. 11. Viaduc de S' Maurice



Fig. 12. Aqueduc de Roquefavour

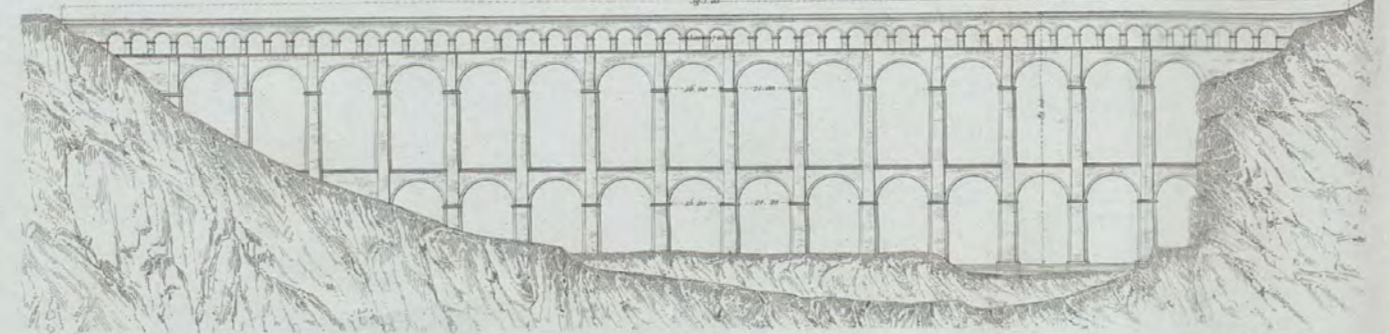

Fig. 13. Viaduc de l'Elsterthal

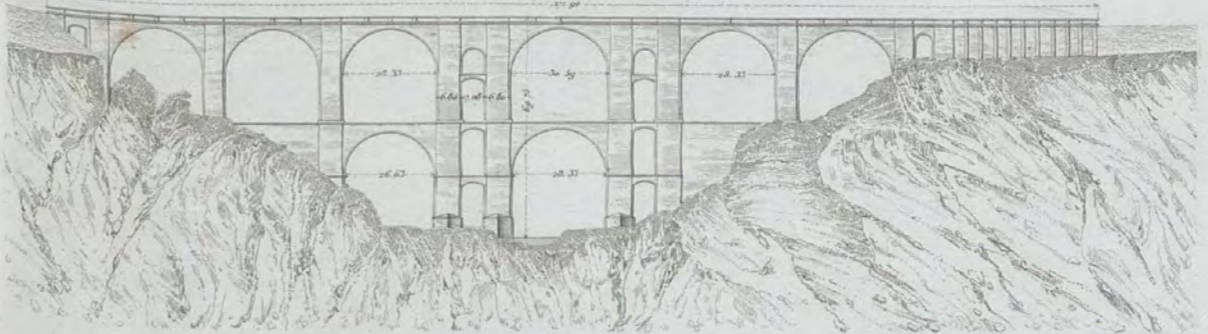

Fig. 14. Viaduc du Roesbaechel

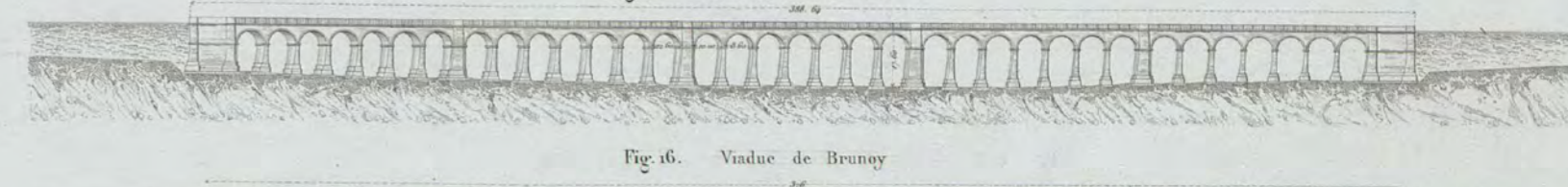

Fig. 15. Viaduc de Chanzy



Fig. 16. Viaduc de Brunoy



Fig. 17. Viaduc de Loekvaod



Fig. 18. Viaduc du chemin de Durham-Junction

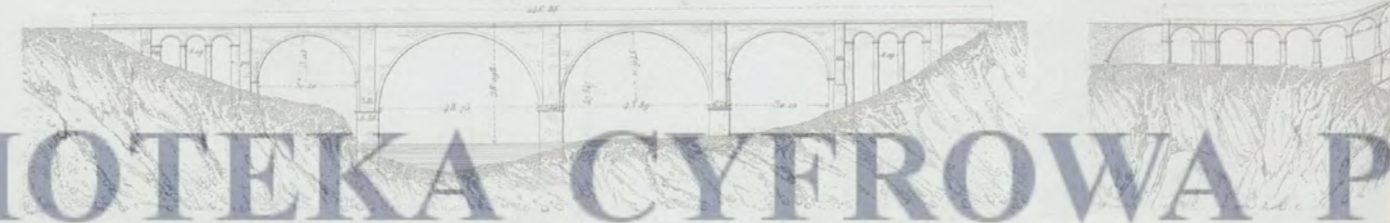

Fig. 19. Viaduc de la Valsérine



Fig. 20. Viaduc de la Combe de Fin

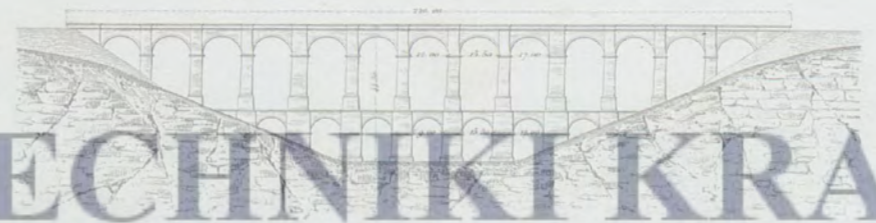

Fig. 21. Viaduc de Comelle



BIBLIOTEKA CYFROWA POLITECHNIKI KRAKOWSKIEJ

Fig. 1. Viaduc de Durham

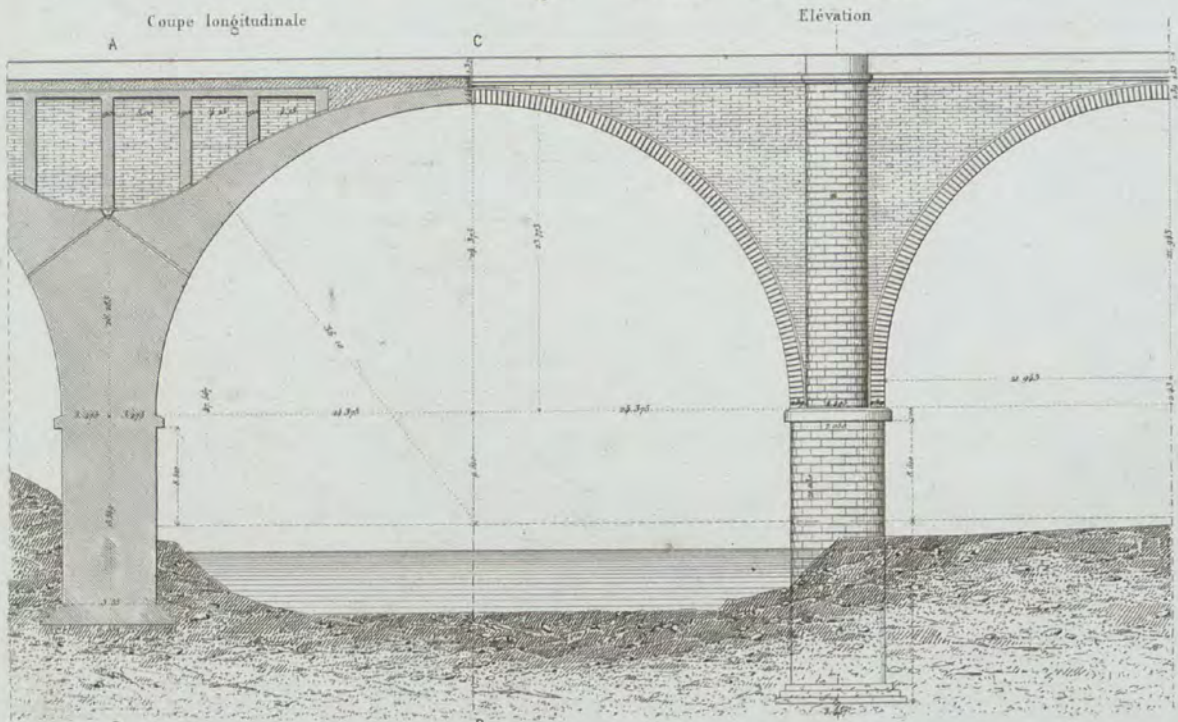

Fig. 1'

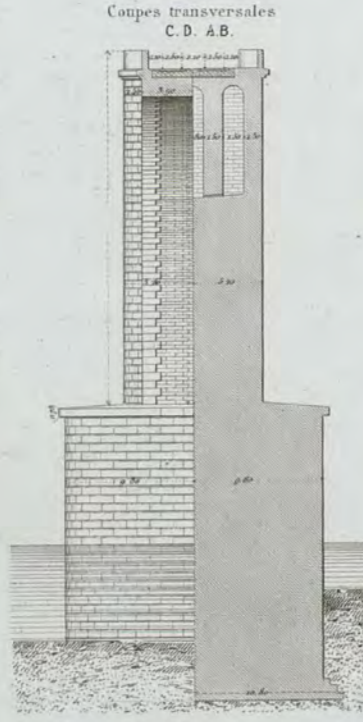

Fig. 2. Viaduc de Lockwood Fig. 2'

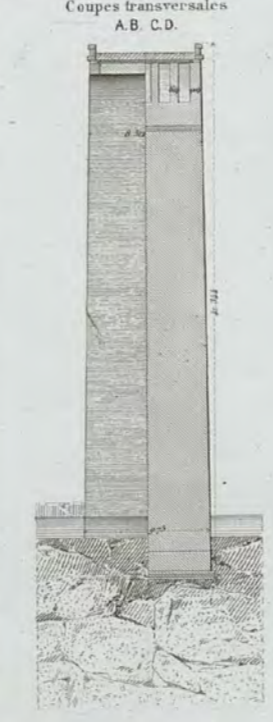
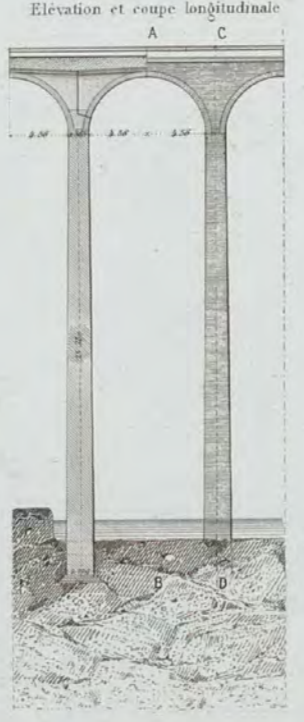

Fig. 5. Viaduc du Goeltzschthal

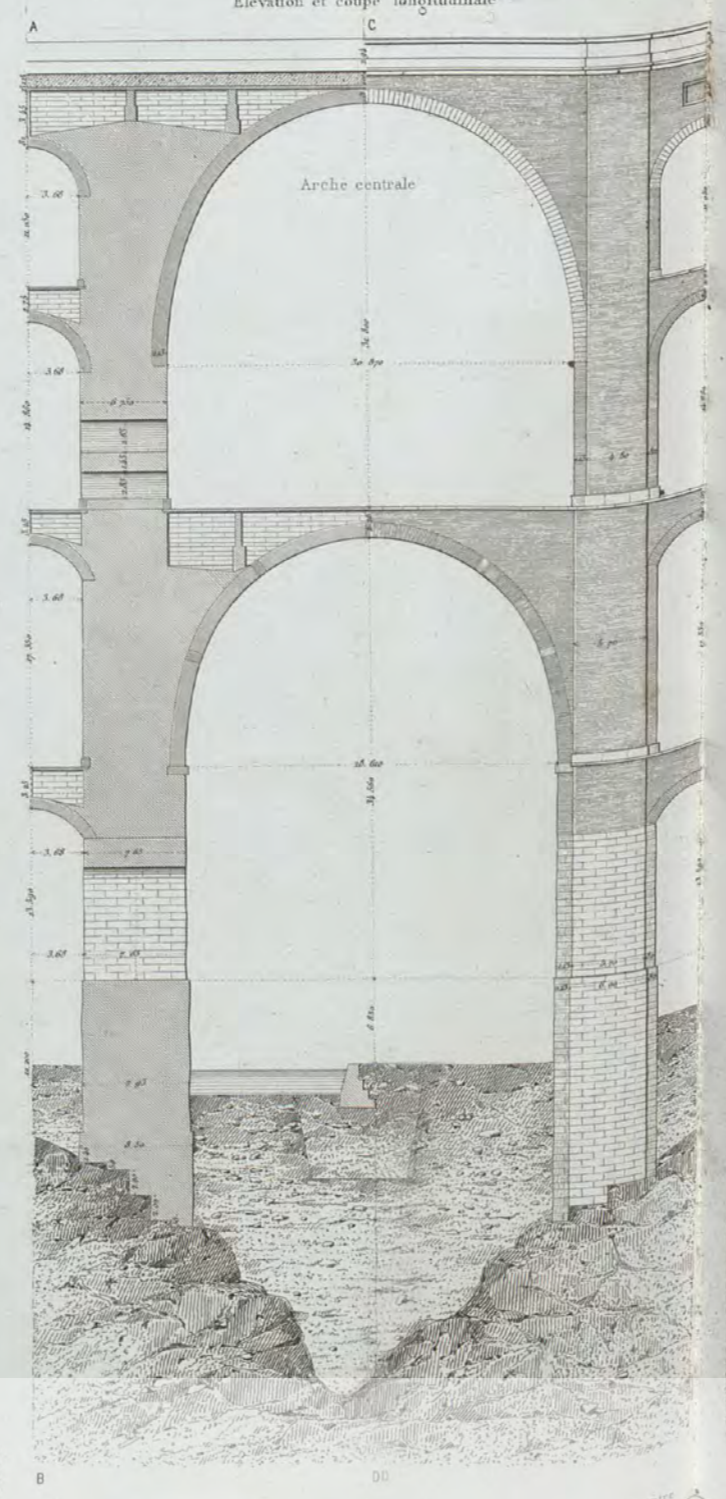

Fig. 5'

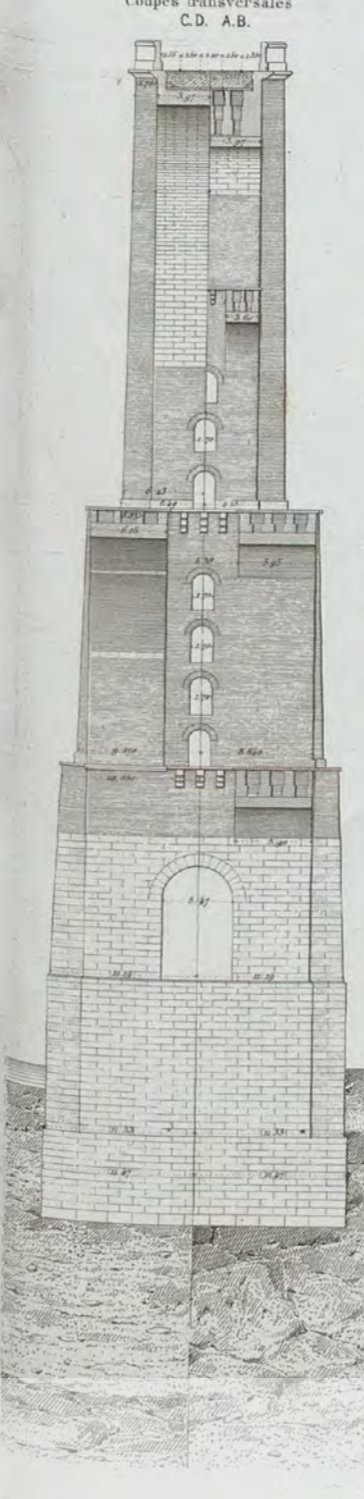

Fig. 4. Viaduc de Comelle

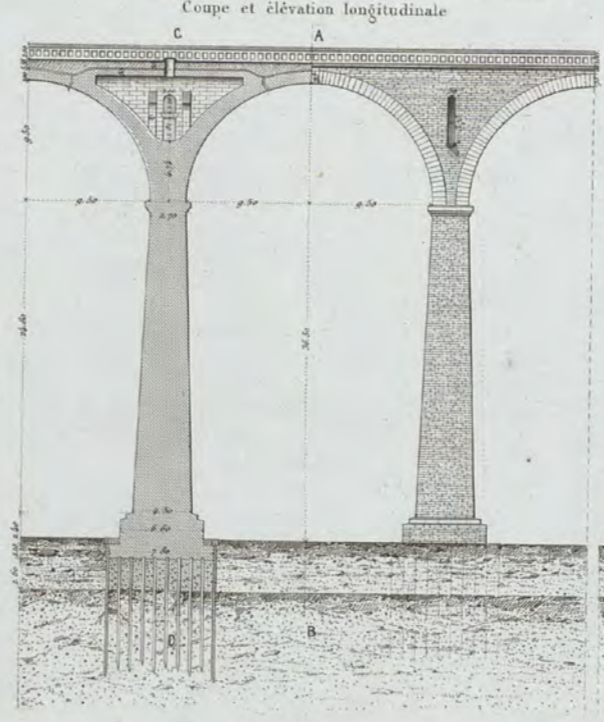

Fig. 4'

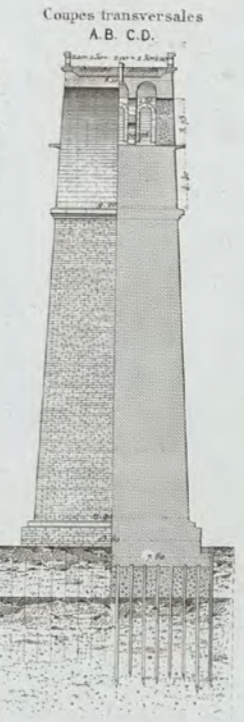

Fig. 5. Viaduc de Nogent-sur-Marne

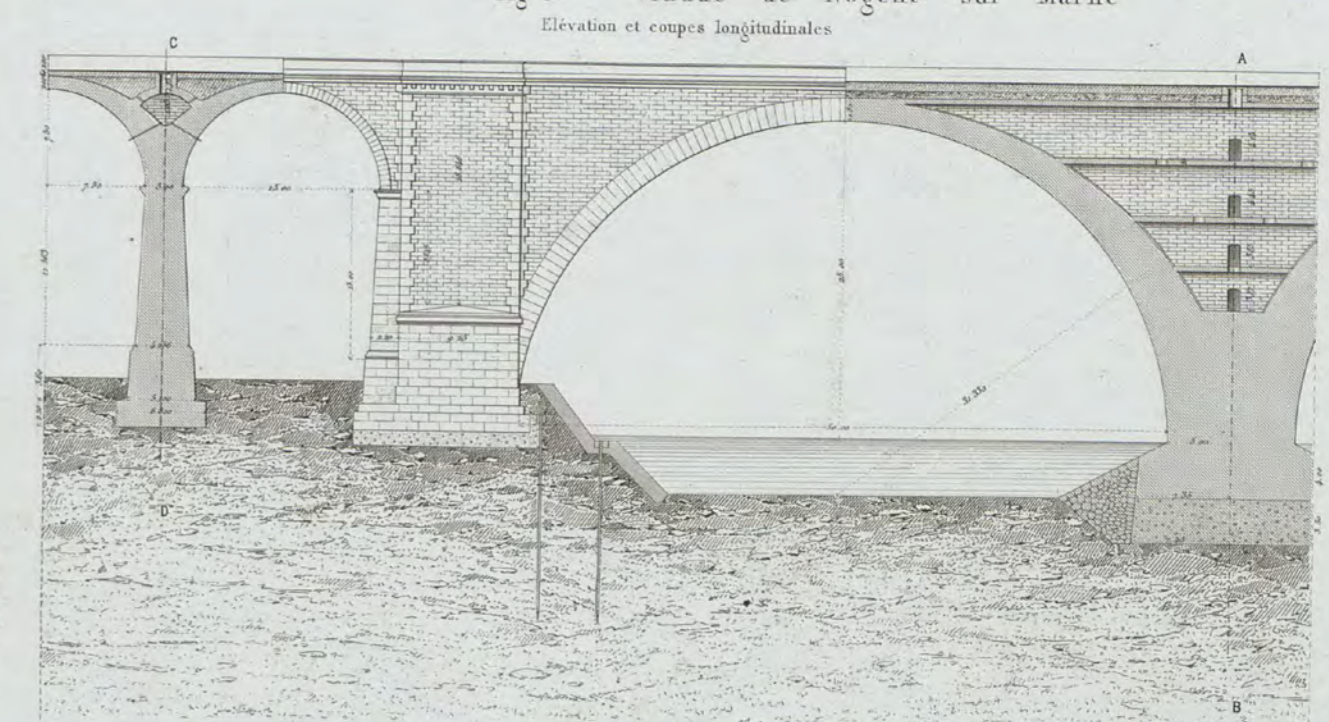

Fig. 5'

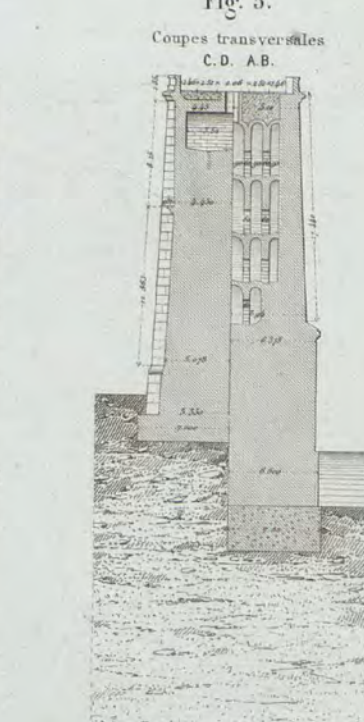

Fig. 6. Viaduc de la Valserine Fig. 6'

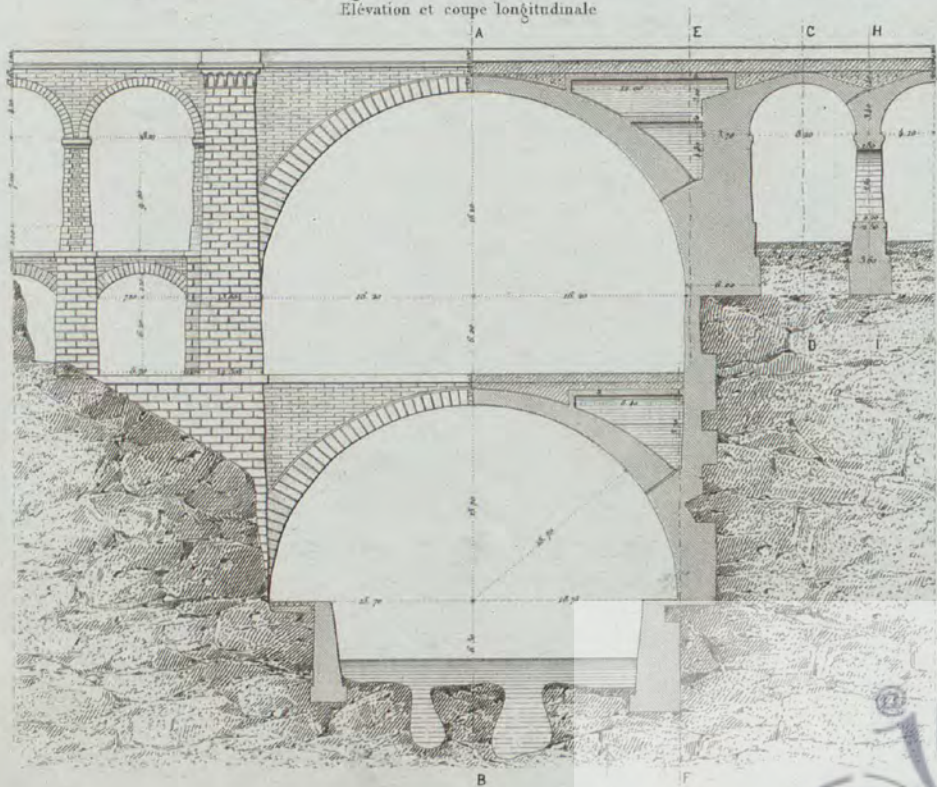

Fig. 6'



Fig. 6'

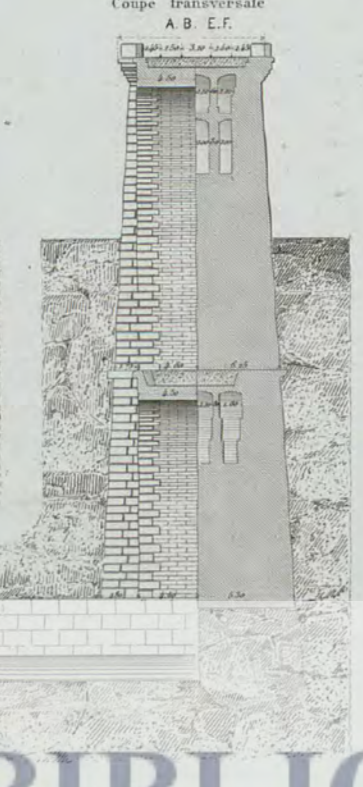

Fig. 7. Viaduc de Chaumont Fig. 7'

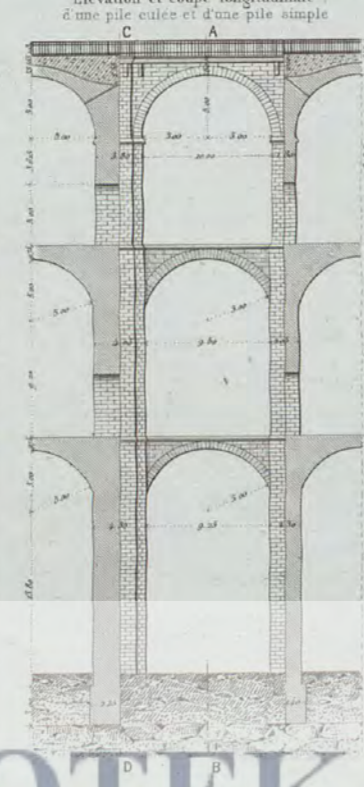

Fig. 7'

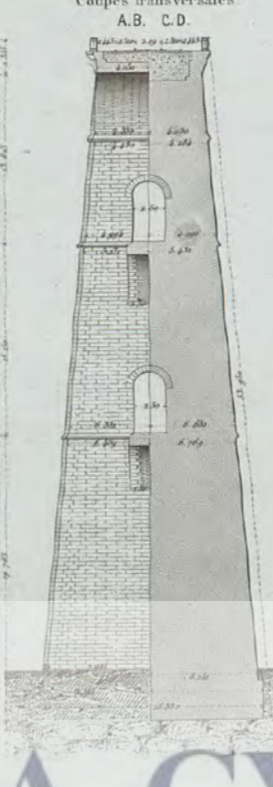

Fig. 8. Viaduc de la Combe de Fin Fig. 8'

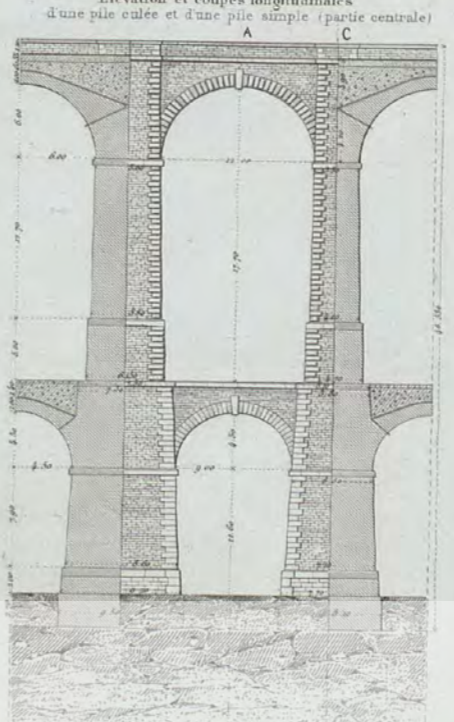

Fig. 8'

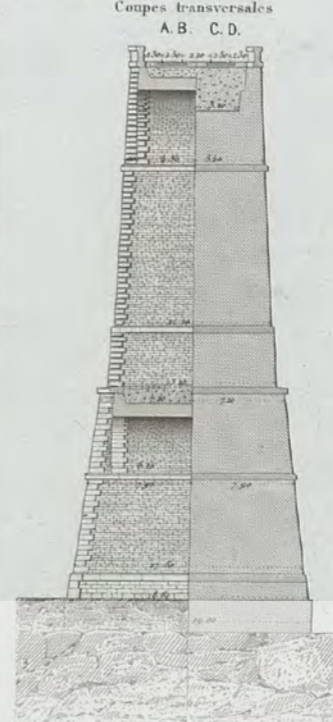

Fig. 9. Viaduc de Barentin

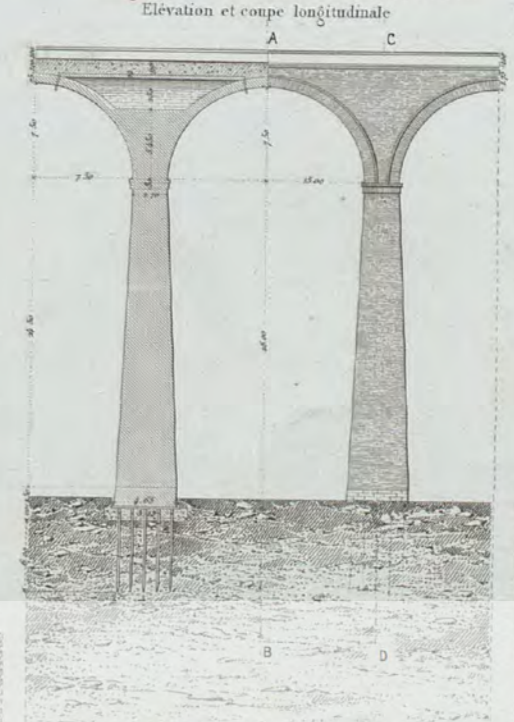

Fig. 9'



Fig. 10. Viaduc de Gorlitz



Fig. 10'

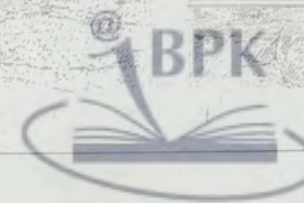
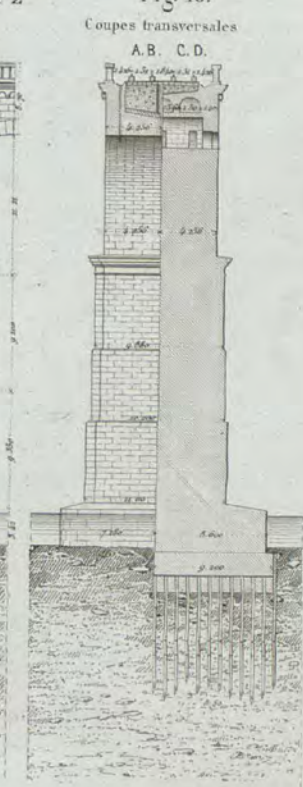

BIBLIOTEKA CYFROWA POLITECHNIKI KRAKOWSKIEJ

Fig. 1. Pont sur la Durance.



Fig. 2. Pont Napoleon (Chemin de ceinture)



Fig. 3. Pont de la Midouze.



Fig. 4. Pont de Plessis-les-Tours, sur la Loire



Fig. 5. Pont de Guignicourt.



Fig. 6. Pont de Rochereuil.



Fig. 7. Pont de Montlouis.

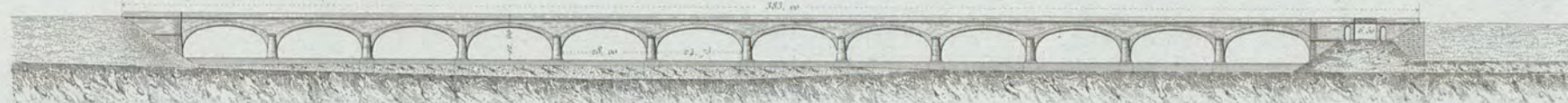

Fig. 8. Pont de l'Essart.



Fig. 9. Pont de Larmignon.



Fig. 10. Pont sur le Nékar.



Fig. 11. Pont aqueduc de St Phlin.



Fig. 12. Pont du Val Benoit.



Fig. 13. Pont sur la baie de la Canche.



Fig. 14. Pont de Wittemberg.



Fig. 15. Pont de l'Alma.



Fig. 16. Pont de Longueville-les-Metz.



Fig. 17. Pont de Port-de-Pille.



Fig. 18. Pont de Langley.

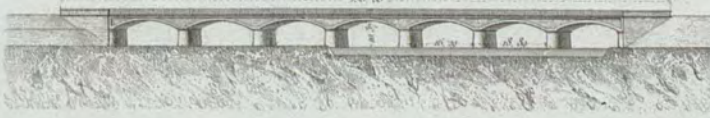

Fig. 19. Pont sur la Ners.



Fig. 20. Pont du Cher.



Fig. 21. Pont de Laversine.



Fig. 22. Pont de Libourne.

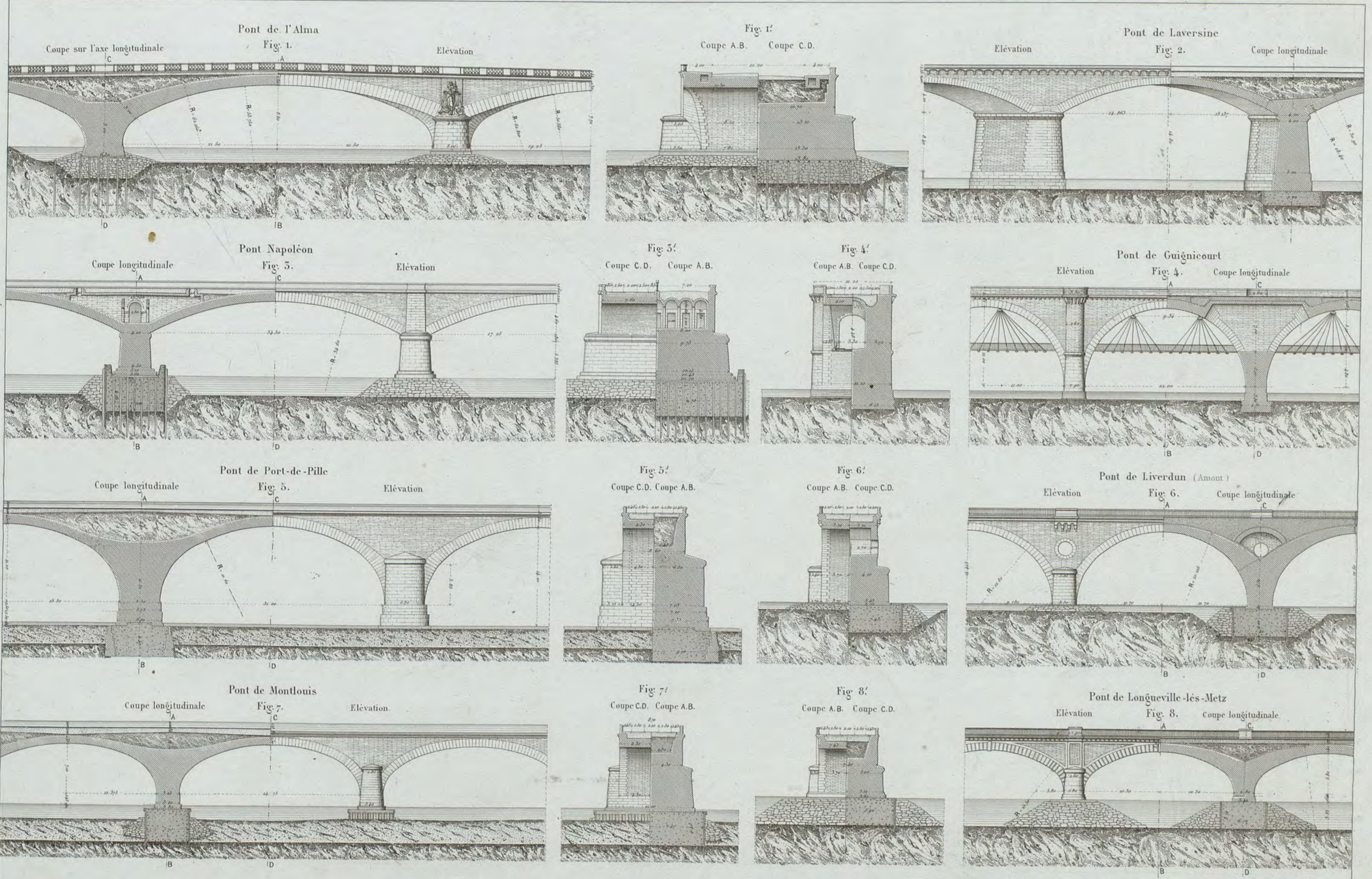

Fig. 23. Pont de Liverdun (Ament)



Echelle 1/1000





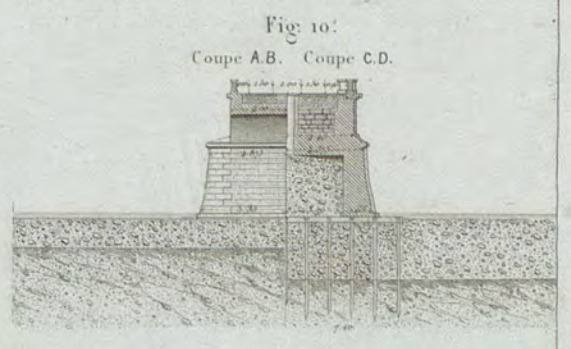
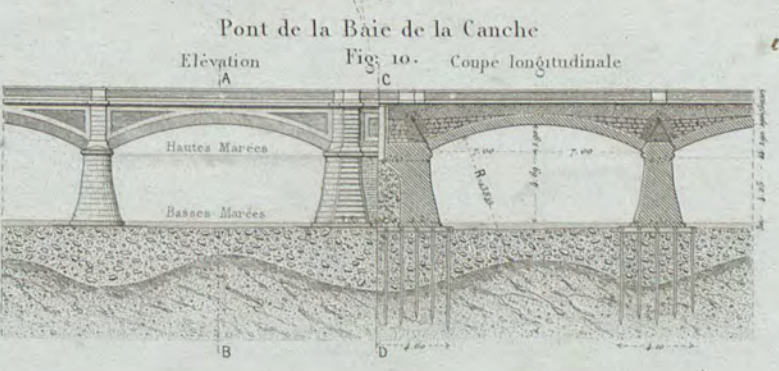
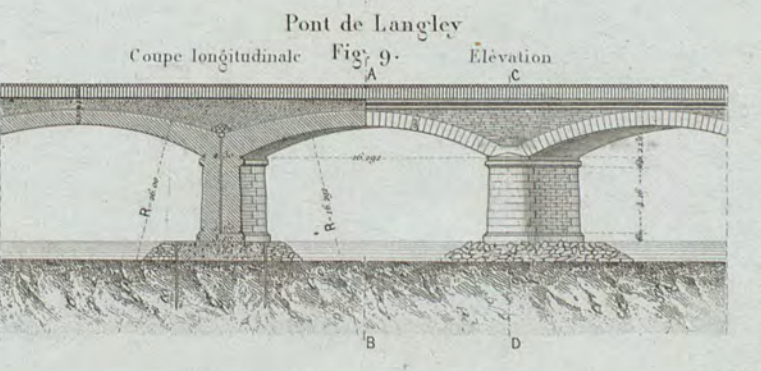
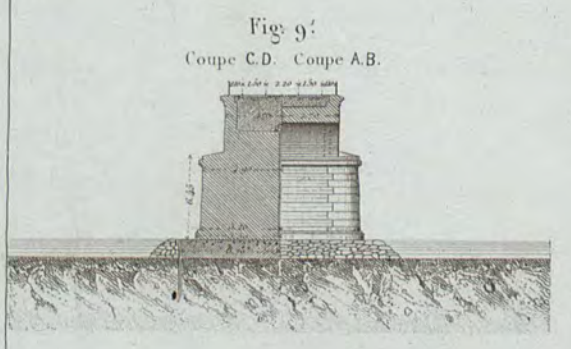
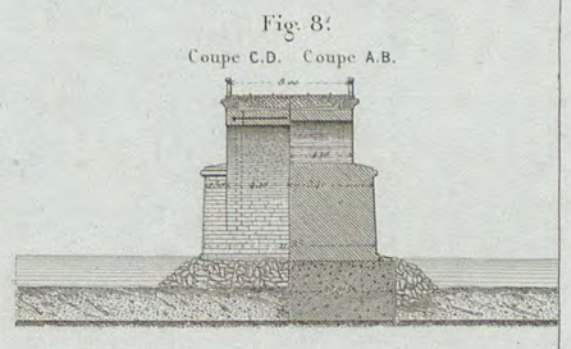
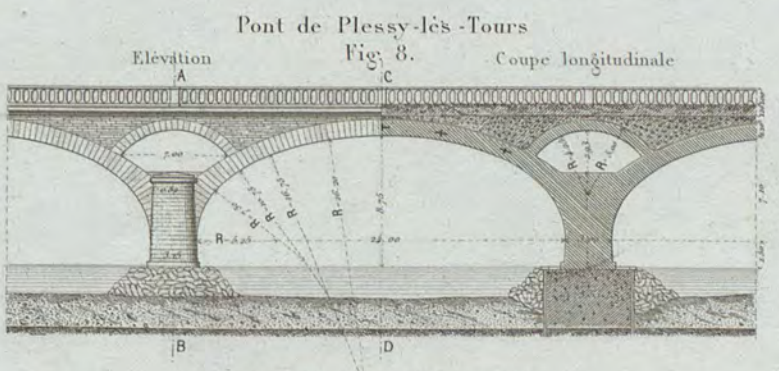
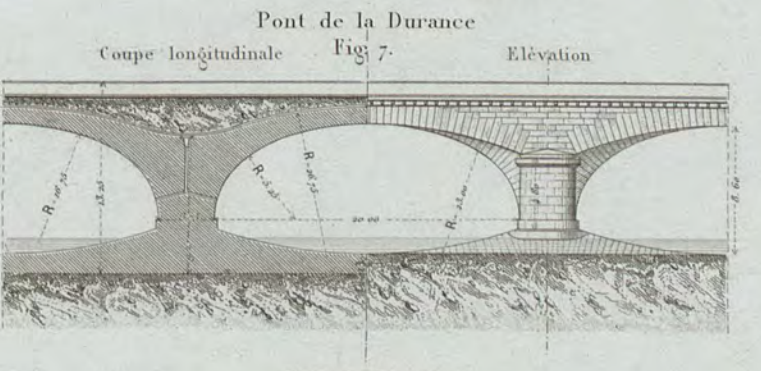
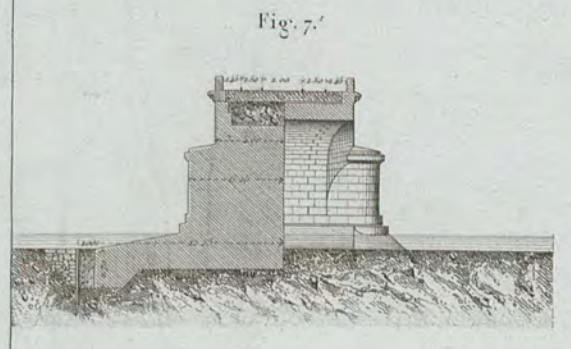
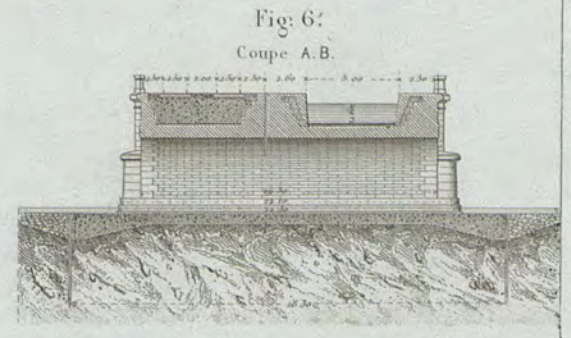
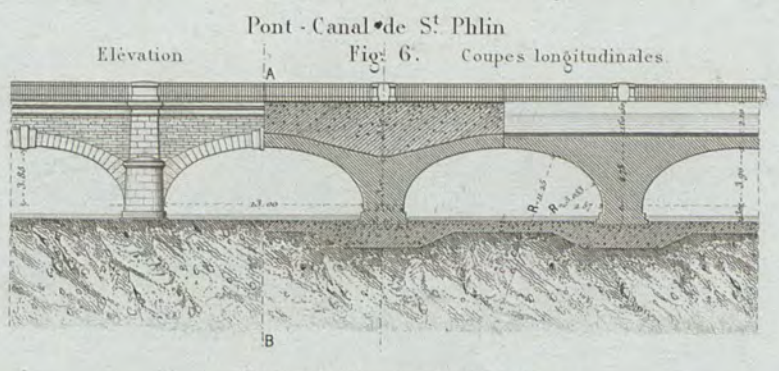
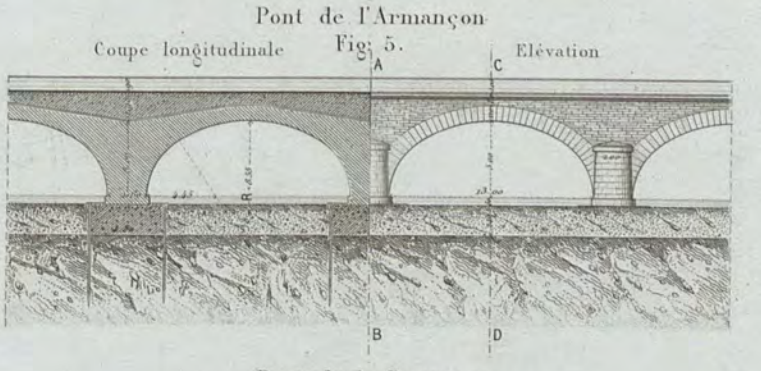
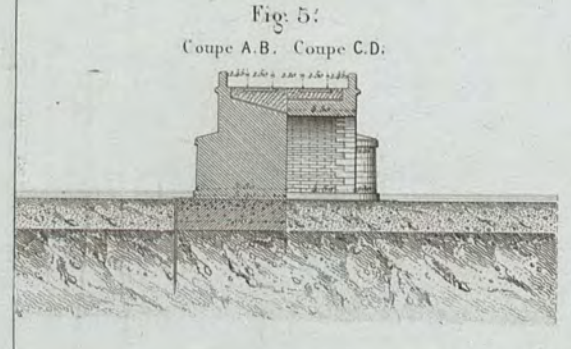
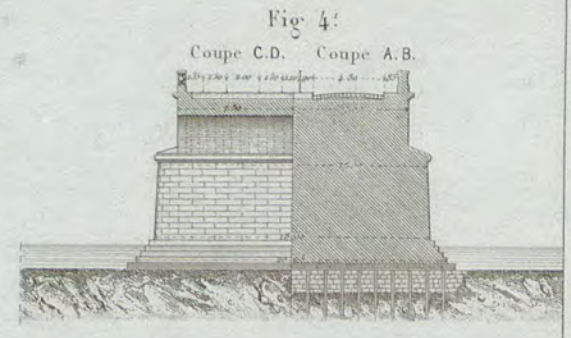
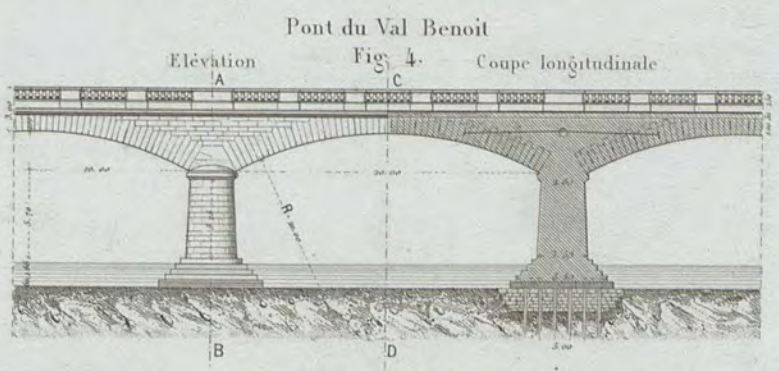
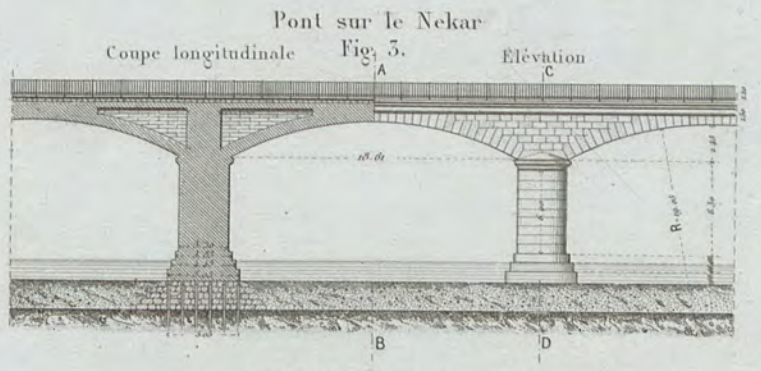
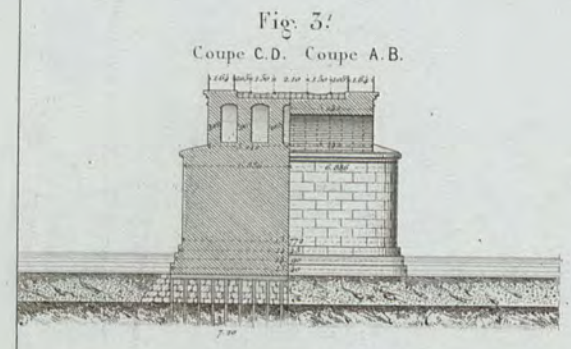
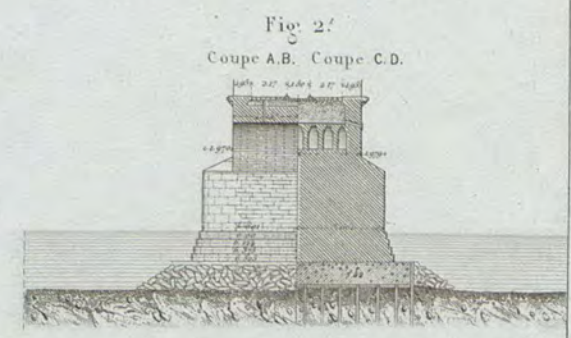
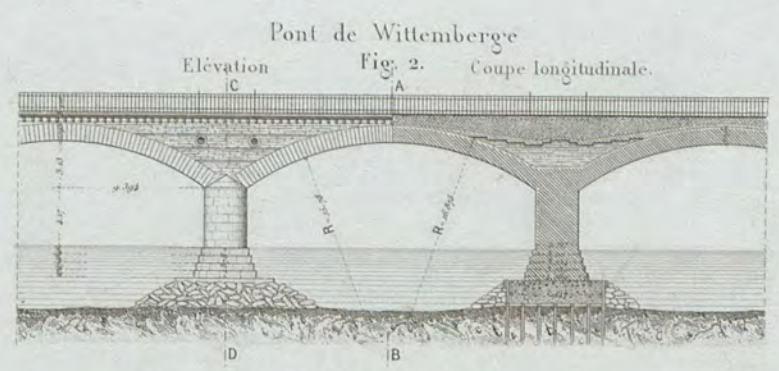
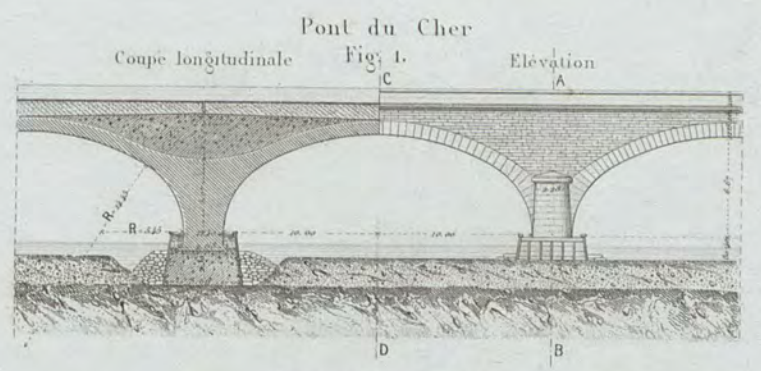
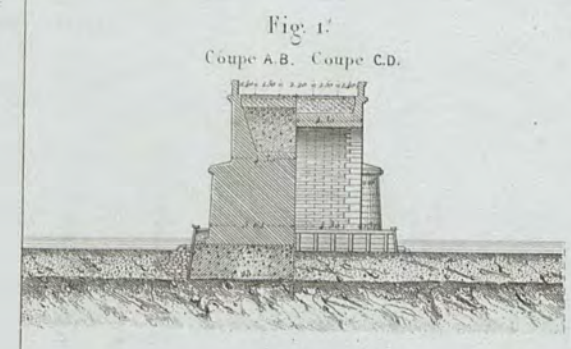

Echelle 0,002

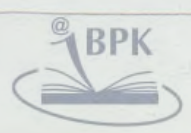



Fig. 1. Viaduc de Château-Fallet.

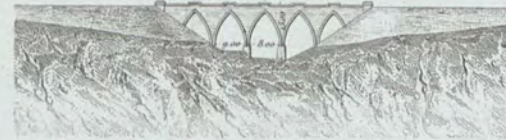

Fig. 2. Viaduc d'Aix-la-Chapelle.

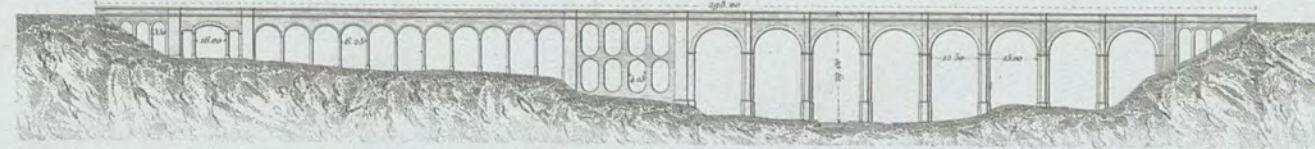

Fig. 3. Viaduc de la Cadière.



Fig. 4. Viaduc de Diémel.

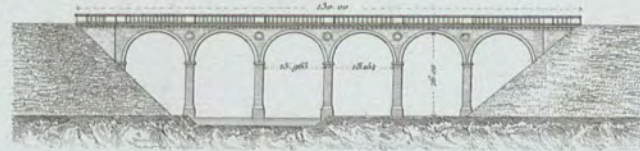

Fig. 5. Viaduc du Port de Vienne.



Fig. 6. Viaduc des Jones.



Fig. 7. Pont d'Auzon.



Fig. 8. Pont du Val St Lambert.

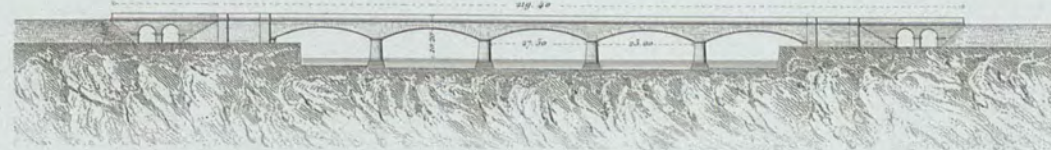

Fig. 9. Pont de la Drôme.



Fig. 10. Pont de Damelevières.

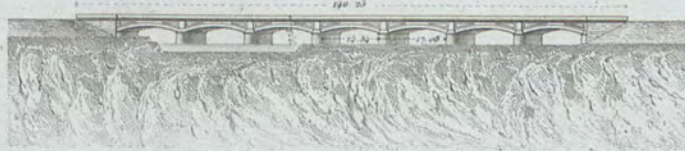

Fig. 11. Pont de Berne.

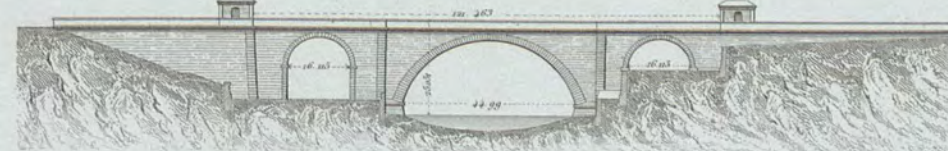

Fig. 12. Viaduc de Bellinghen.



Fig. 13. Viaduc de Malaunay.



Fig. 14. Viaduc sur la Galaure.



Fig. 15. Viaduc de Tavers.



Fig. 16. Pont en aval de Mézières (sur la Meuse)

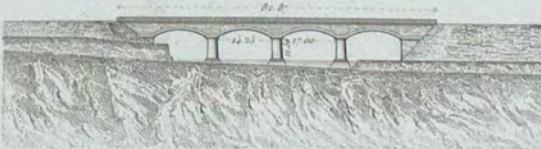

Fig. 17. Viaduc de Goldach.



Fig. 18. Viaduc des Riaux.



Fig. 19. Viaduc de l'Arc.

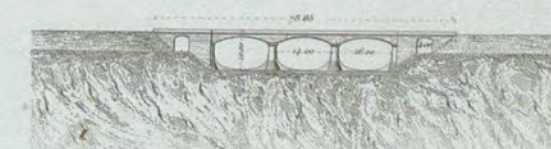

Fig. 20. Pont sur la Vilaine.

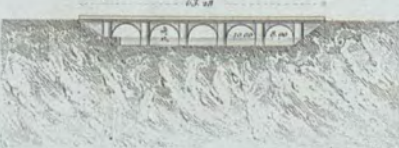

Fig. 21. Viaduc de l'Amance.

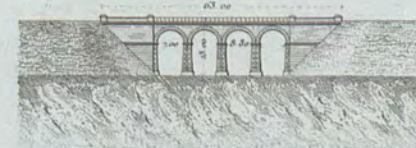

Fig. 22. Viaduc de la Vesdre.



Fig. 23. Viaduc de Baou.



Fig. 24. Viaduc des Aygalades.

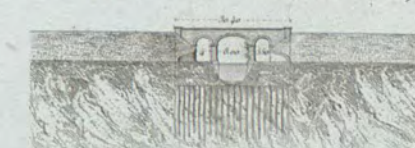

Echelle 0.0005.

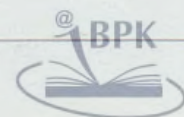

Fig. 1. Viaduc sur les lagunes de Venise.



Fig. 2. Viaduc à la Traversée de Nîmes.



Fig. 5. Viaduc d'Argentré.



Fig. 4. Pont et Viaduc de Wittemberg.



Fig. 5. Viaduc du Saalon.

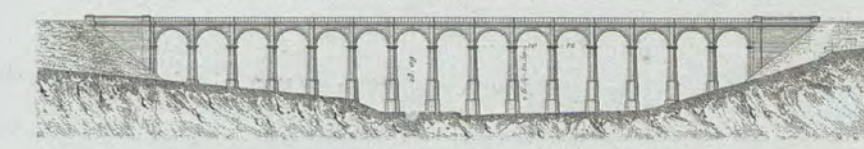

Fig. 6. Viaduc de Tarascon.



Fig. 7. Viaduc d'Arles.

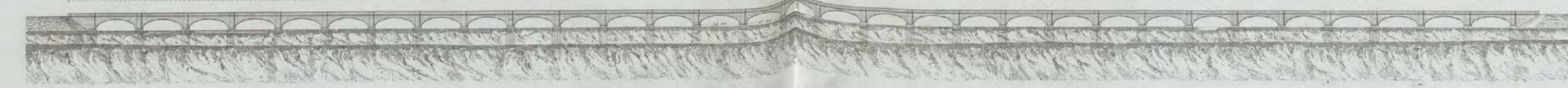

Fig. 8. Viaduc de S<sup>t</sup> Chamas.

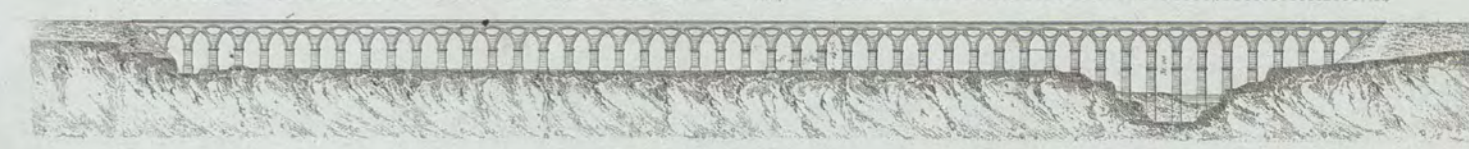

Fig. 9. Viaduc de la Manse.

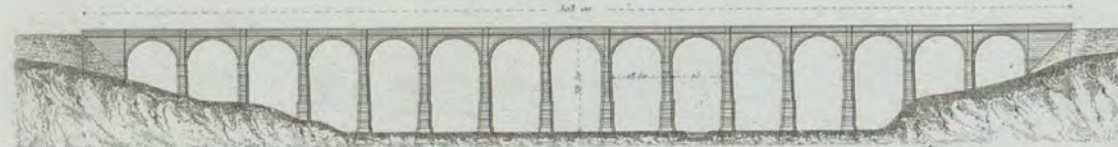

Fig. 10. Viaduc sur la Vallée de l'Ouse.



Fig. 11. Viaduc de Mireville.

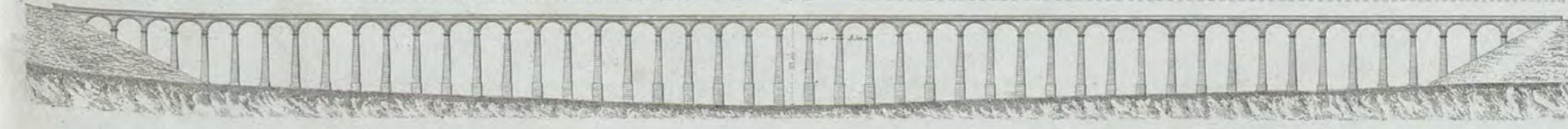

Fig. 12. Viaduc d'Hortes.

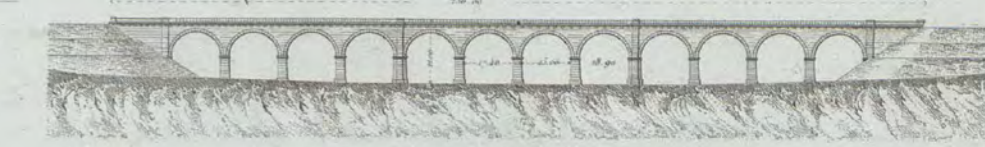

Fig. 15. Viaduc de Beaugency.



Fig. 14. Viaduc de Rumlingen.



Fig. 15. Viaduc de Bietigheim.

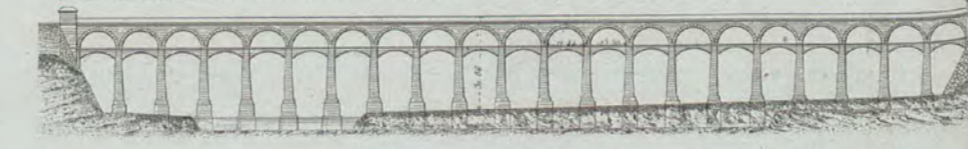

Fig. 16. Viaduc de Dolhain.



Fig. 17. Viaduc de la Selle.

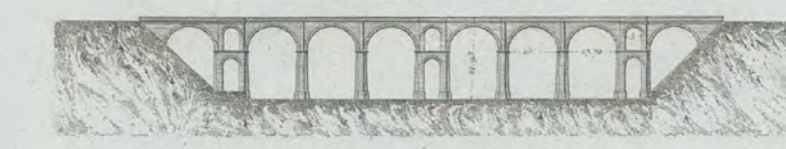

Fig. 18. Viaduc de Virolloy.



Fig. 19. Viaduc de Dinan.

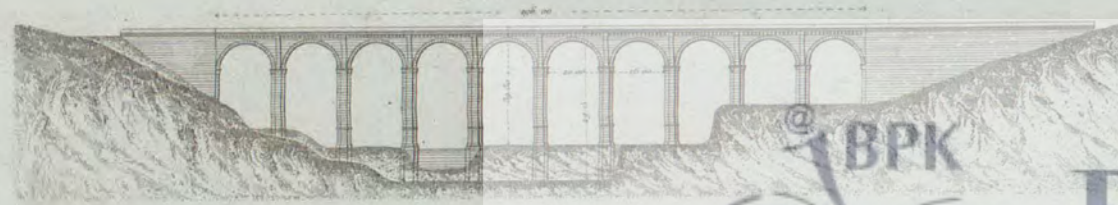

Fig. 20. Viaduc du Val Fleury.

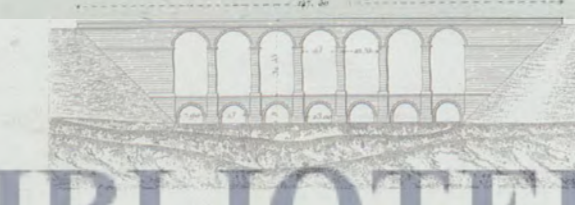

Fig. 21. Viaduc de S<sup>t</sup> Germain.



Fig. 22. Viaduc de la Combe Bouchard.



Fig. 25. Viaduc de la Mayenne à Laval.



Fig. 24. Viaduc de la Fure.

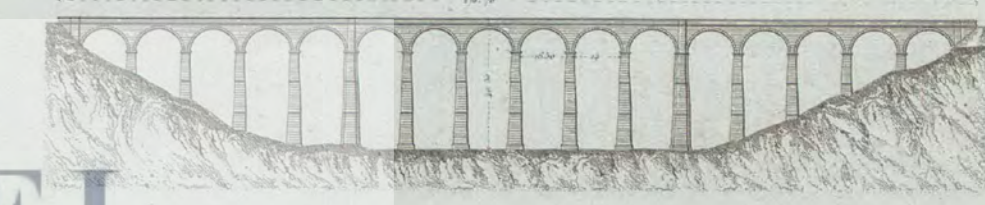

BIBLIOTEKA CYFROWA POLITECHNIKI KRAKOWSKIEJ

Fig. 1. Viaduc du Saalon.

Fig. 2. Viaduc de Rumligen.

Fig. 3. Pont sur l'Aar, à Berne.

Fig. 3'. Pont sur l'Aar, à Berne.

Fig. 4. Viaduc de Bellingen.

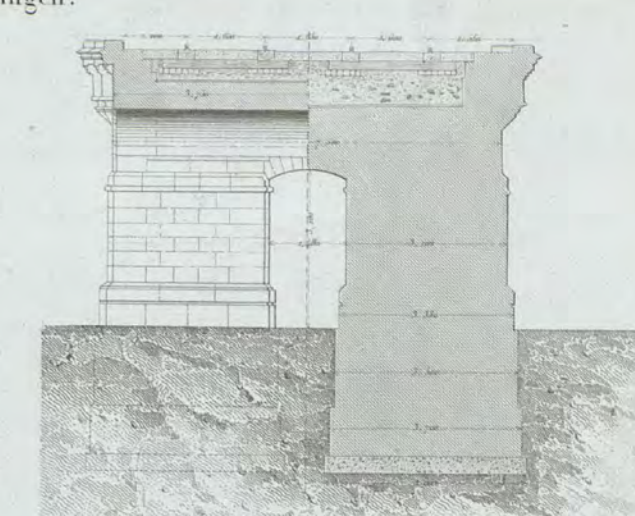
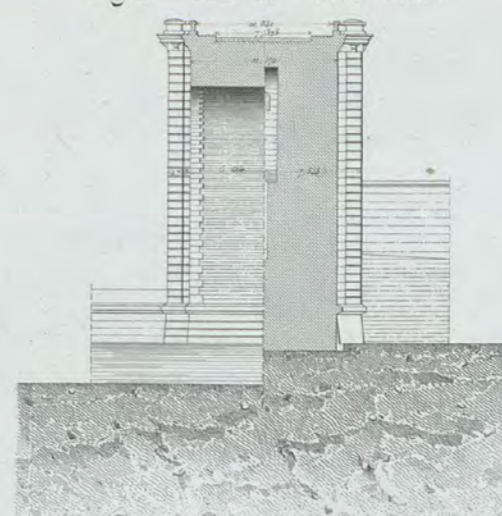
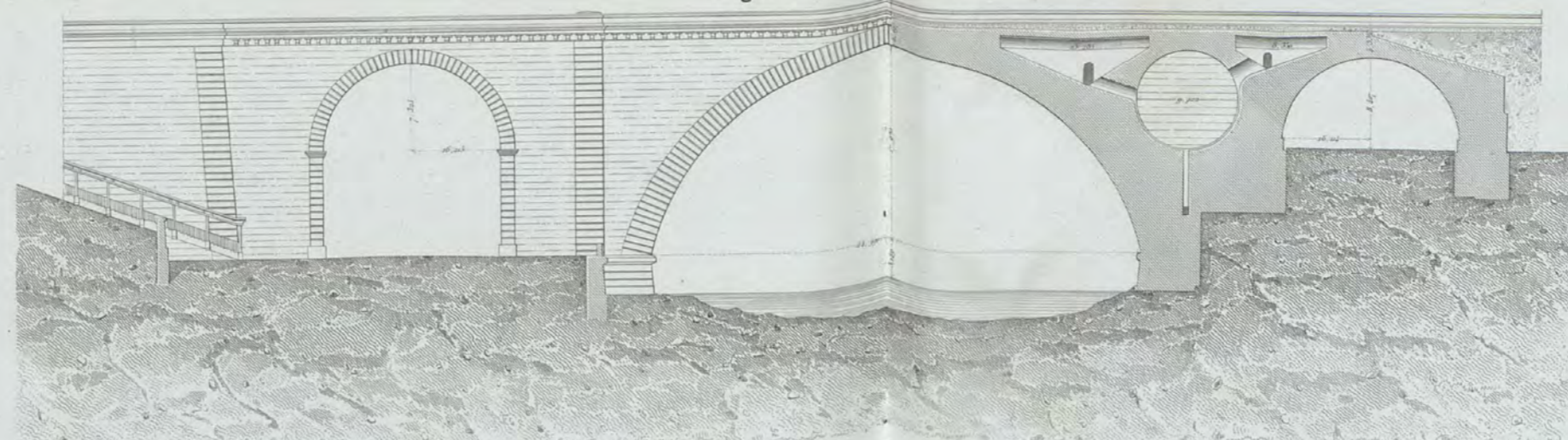
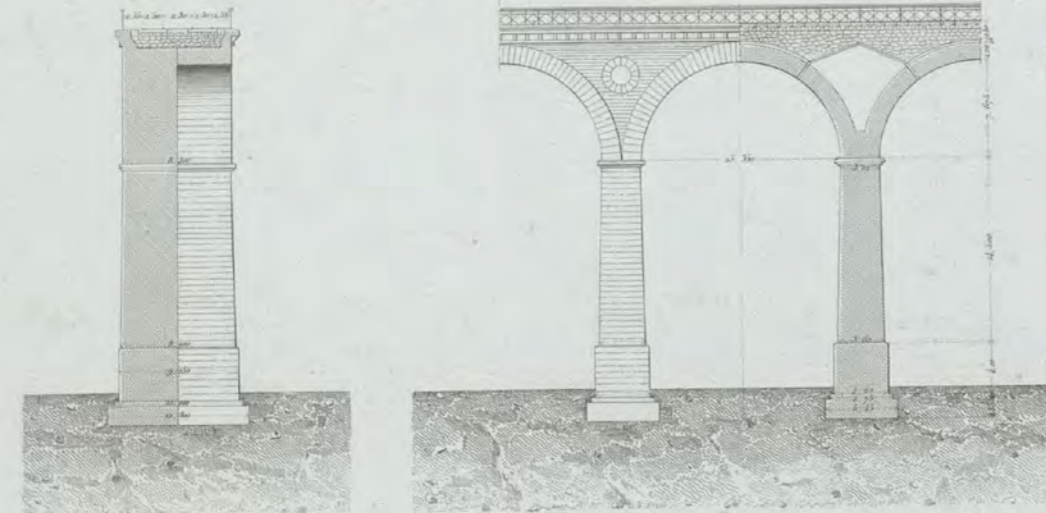
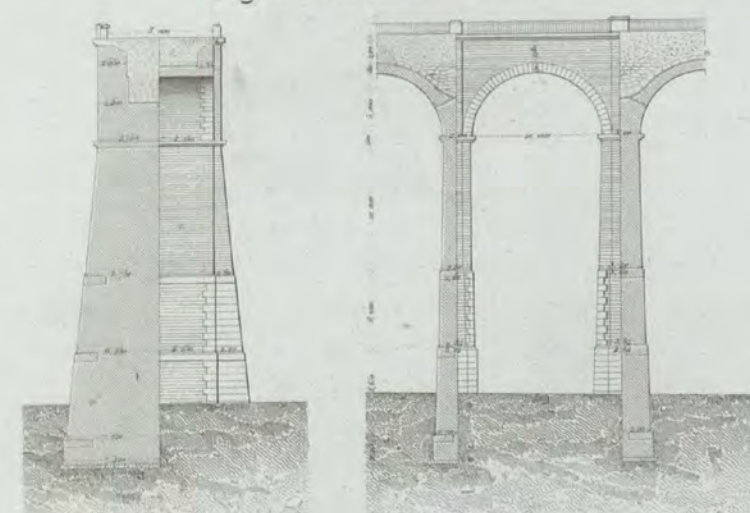

Fig. 5. Viaduc de Dolhain.

Fig. 6. Viaduc de Beaugency.

Fig. 7. Viaduc des Riaux.

Fig. 8. Viaduc des Jones.

Fig. 9. Viaduc d'Hortes.

Fig. 10. Viaduc de St Germain.

Fig. 10'. Viaduc de St Germain.

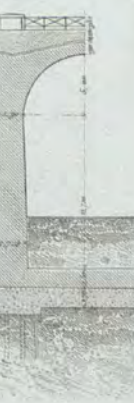
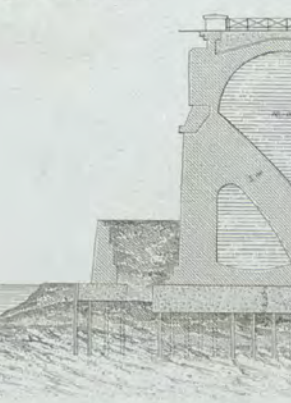
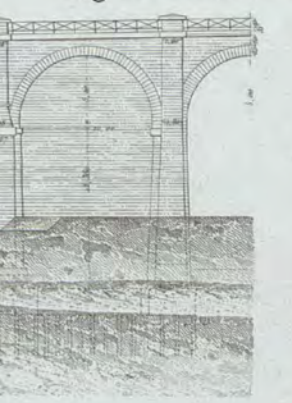
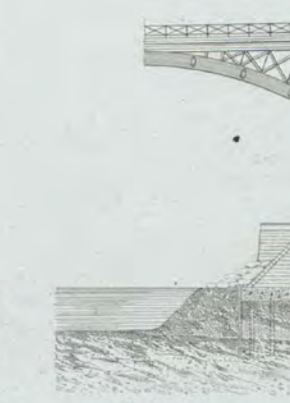
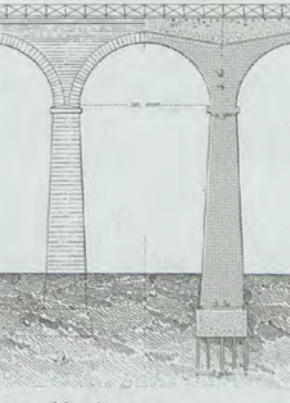
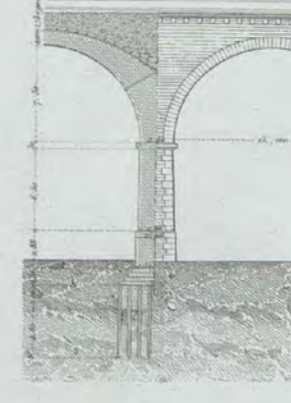
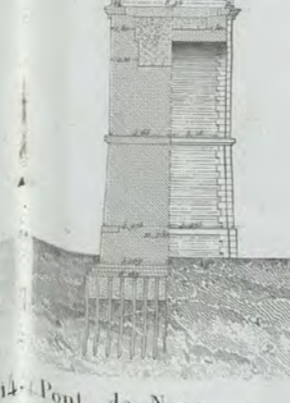
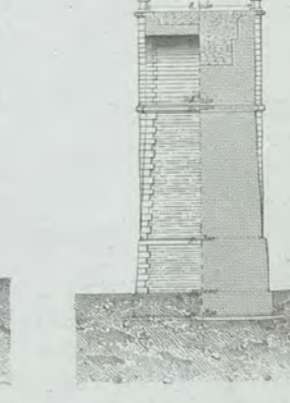
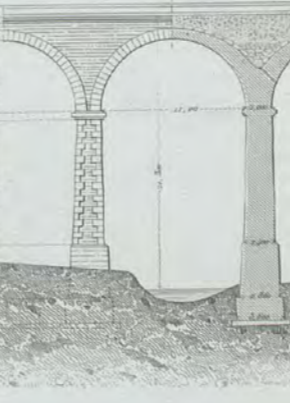
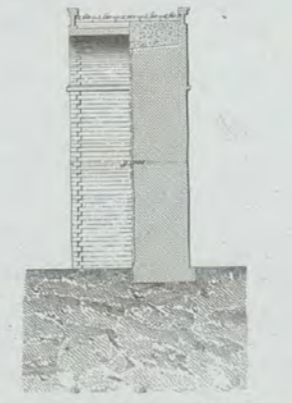
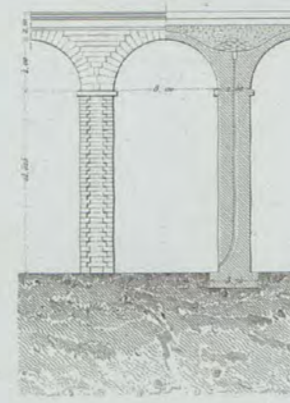
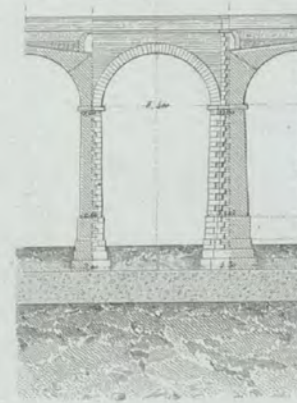
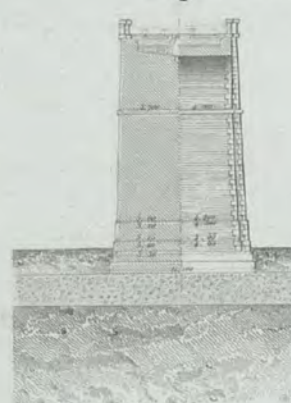
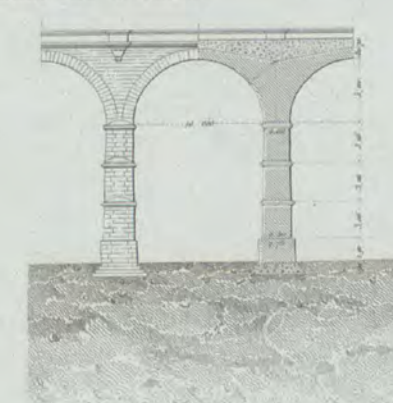
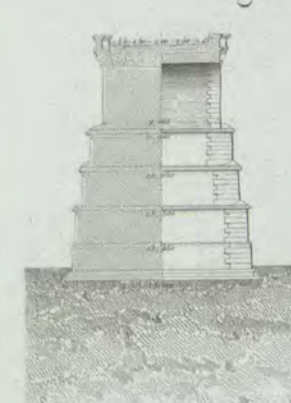

Fig. 11. Viaduc de l'Amanee.

Fig. 12. Pont du Val St Lambert.

Fig. 15. Viaduc de Viroflay.

Fig. 14. Pont de Ners.

Fig. 15. Pont près Mézières.

Fig. 16. Viaduc de St Maurice.

Fig. 17. Pont de l'Arc.

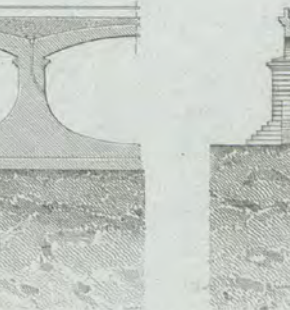
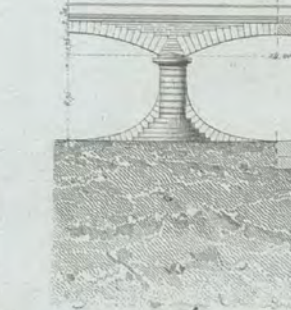
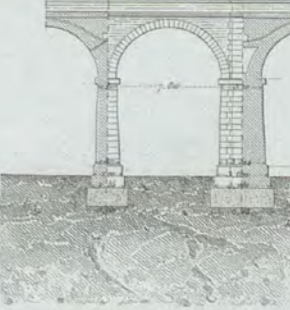
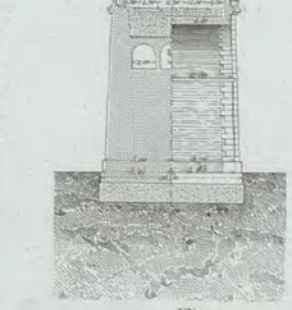
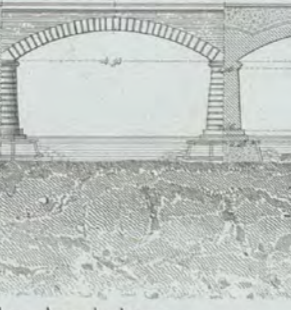
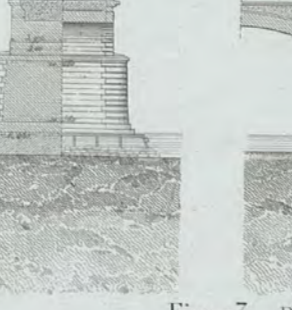
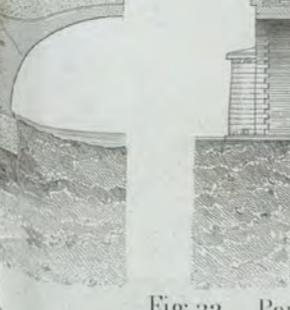
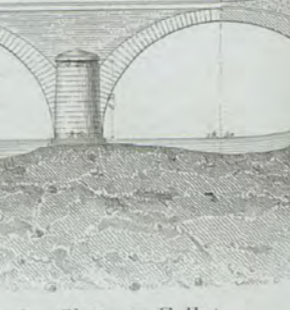
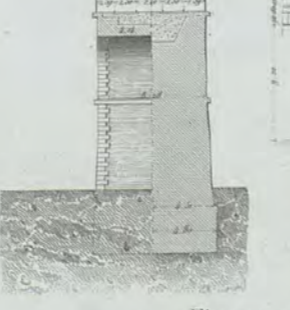
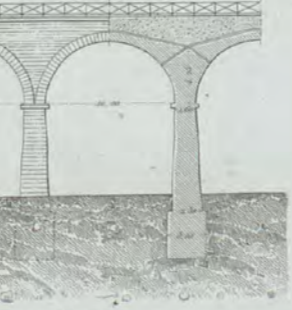
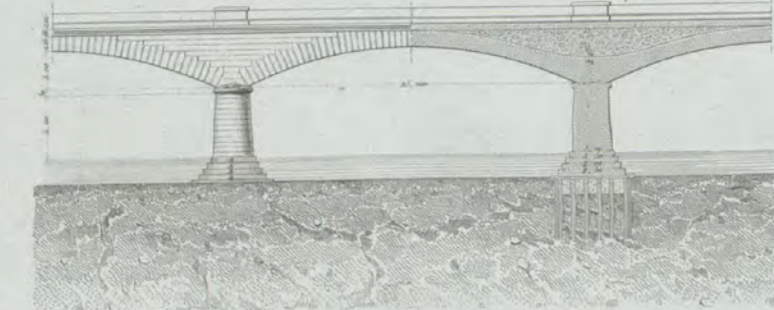
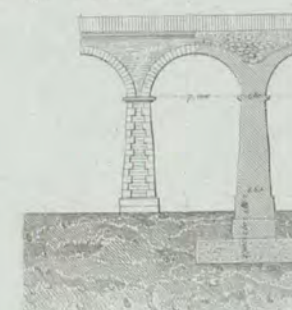
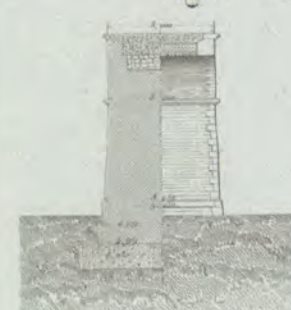

Fig. 18. Pont sur la Vilaine.

Fig. 19. Pont de Damelevières.

Fig. 20. Pont du Baou.

Fig. 21. Pont du Château-Fallet.

Fig. 22. Pont de la Cadière.

Fig. 23. Pont des Ayalades.

Fig. 24. Viaduc des lagunes de Venise.

Fig. 25. Viaduc d'Argentré.

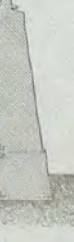
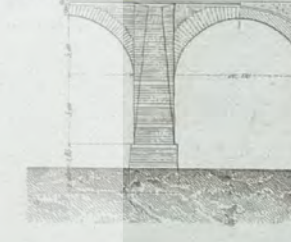
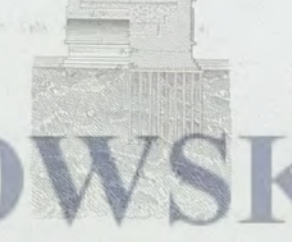
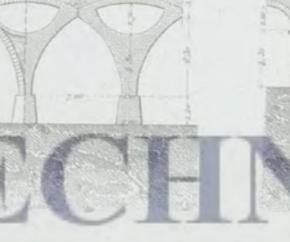
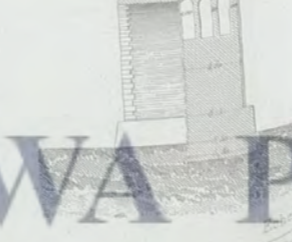
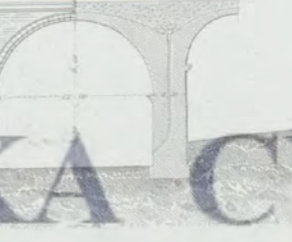
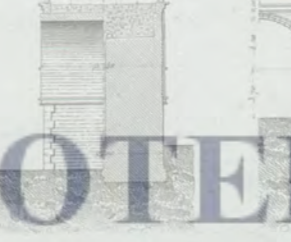
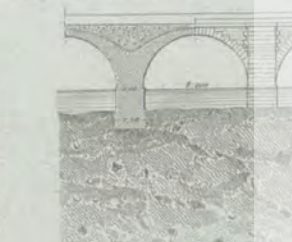
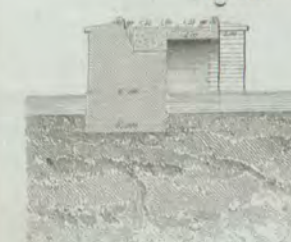

BIBLIOTEKA CYFROWA POLITECHNIKI KRAKOWSKIEJ

Fig. 1. Viaduc de Diémeil.

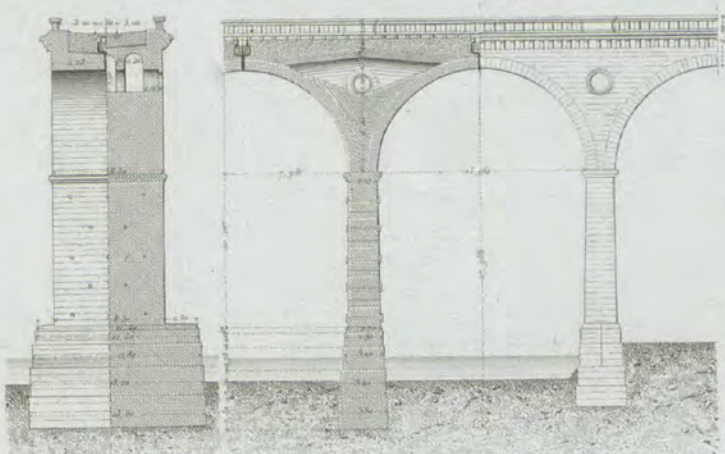

Fig. 2. Viaduc de Laval.

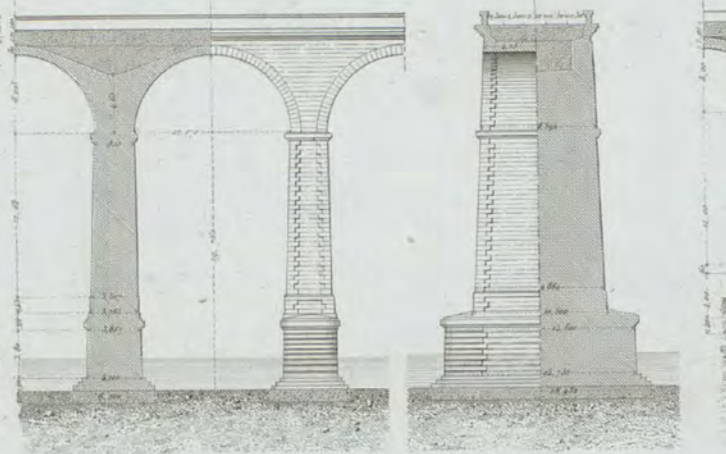

Fig. 3. Viaduc de Brunoy.

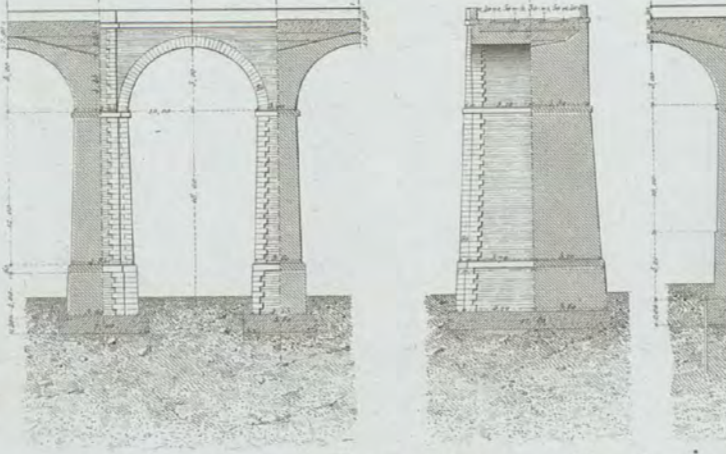

Fig. 4. Viaduc du Loing.

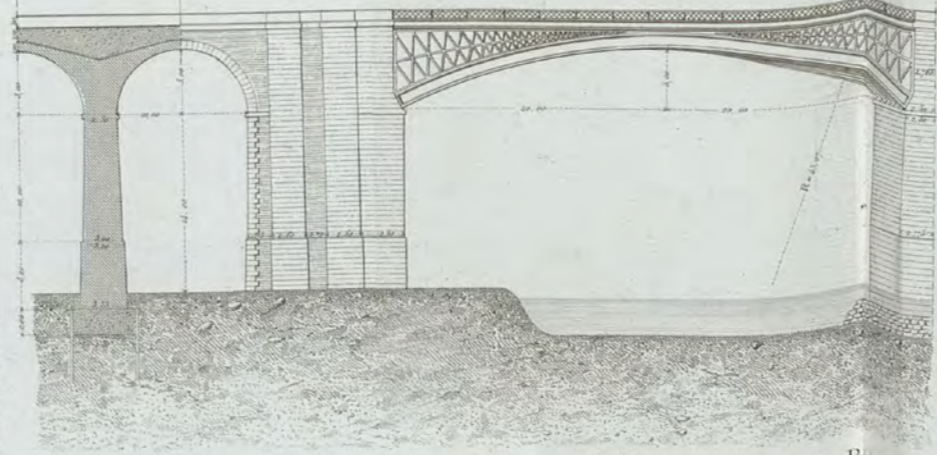

Fig. 5. Viaduc de Malaunay.

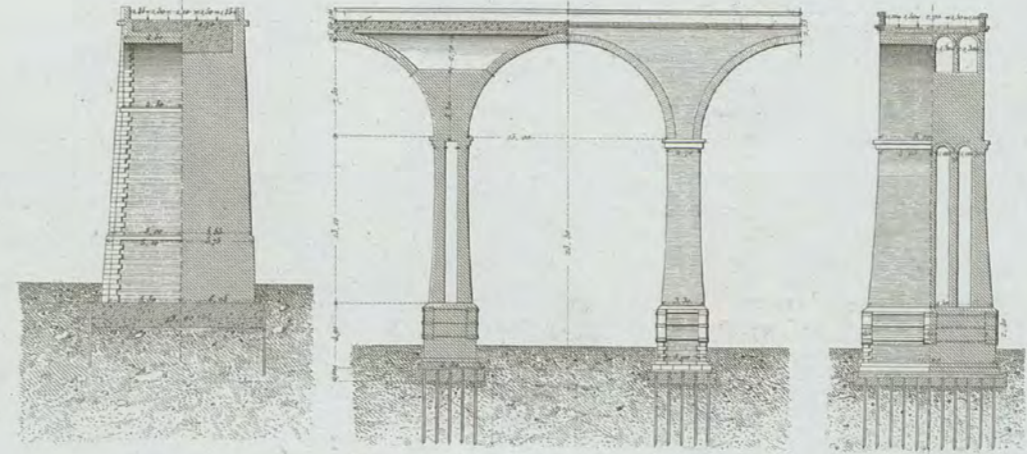

Fig. 6. Viaduc de Goldach.

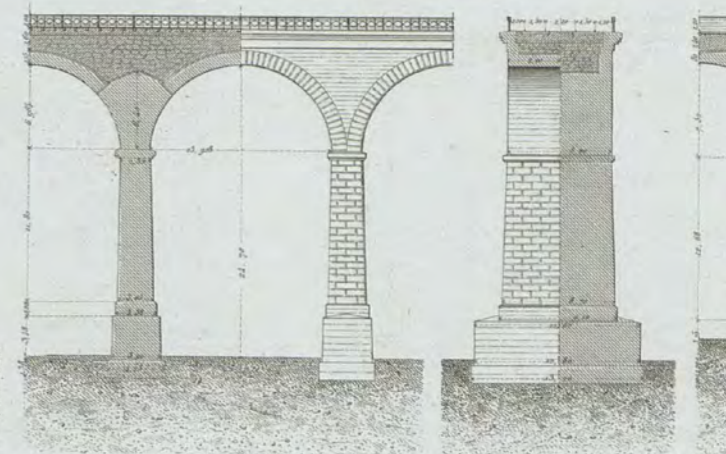

Fig. 7. Viaduc de la Selle.

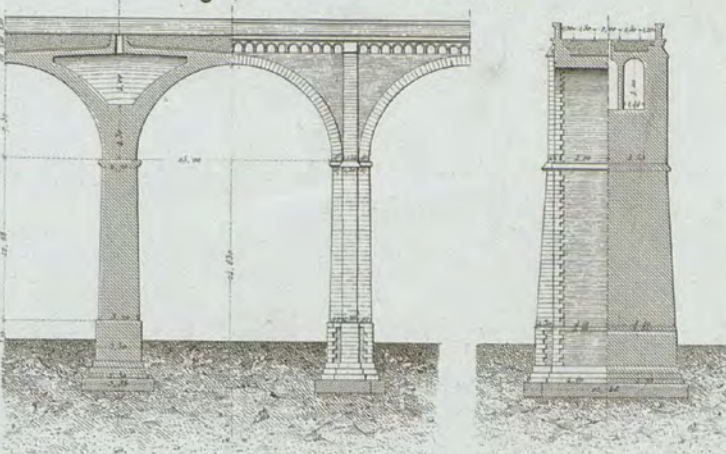

Fig. 8. Viaduc de la Vouzie.

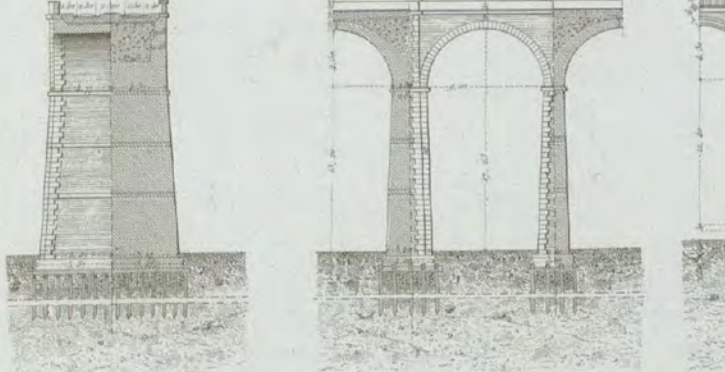

Fig. 9. Viaduc de la Roesbaëchel.

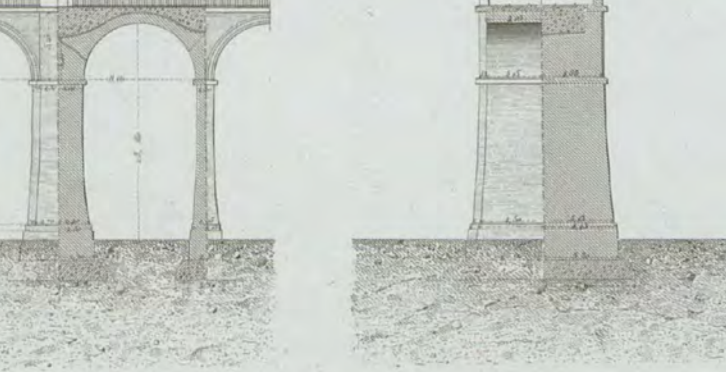

Fig. 10. Viaduc de Changis.

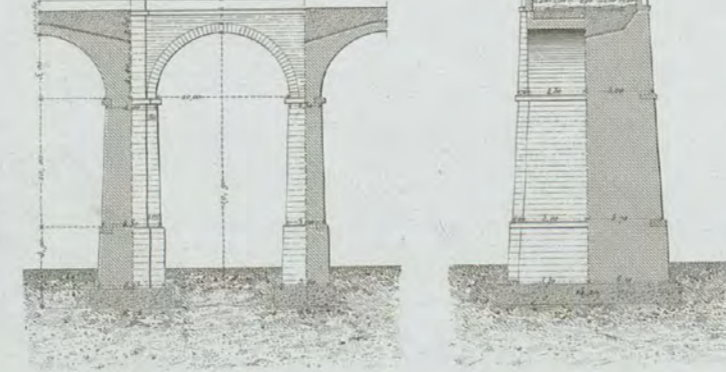

Fig. 11. Aqueduc de Bonnelavouir.

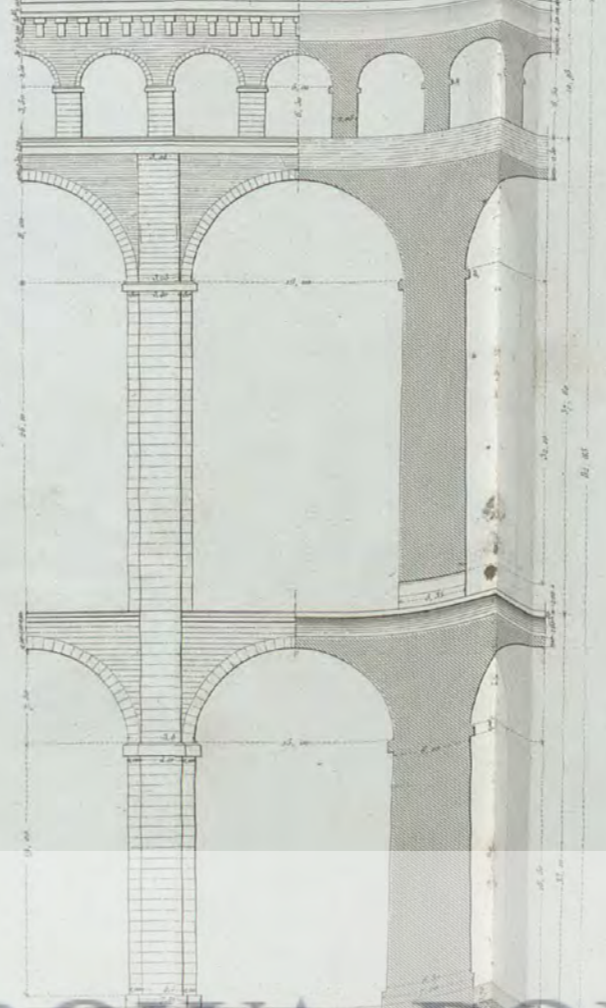

Fig. 12. Viaduc de la Lague.

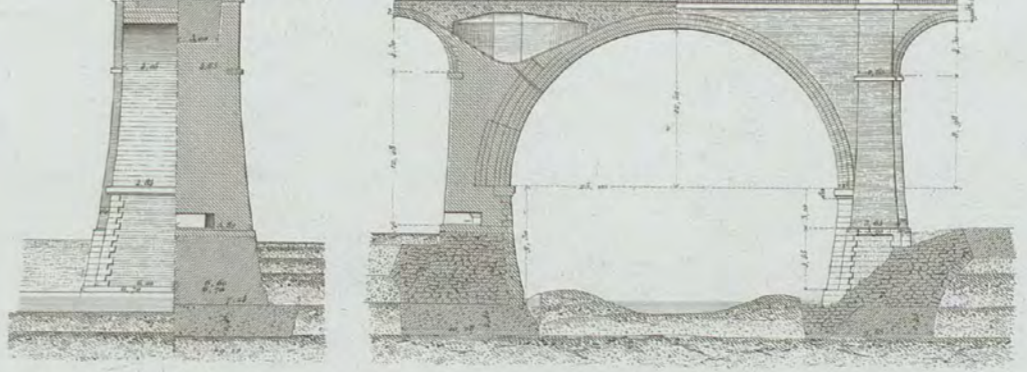

Fig. 13. Viaduc de l'Indre.



Fig. 14. Viaduc de Chantilly.

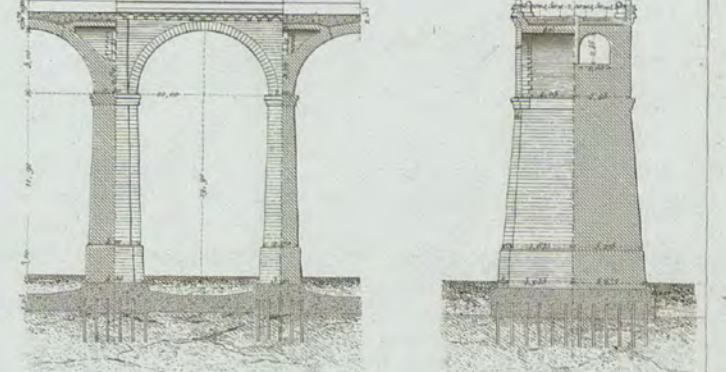

Fig. 15. Viaduc de la Mause.

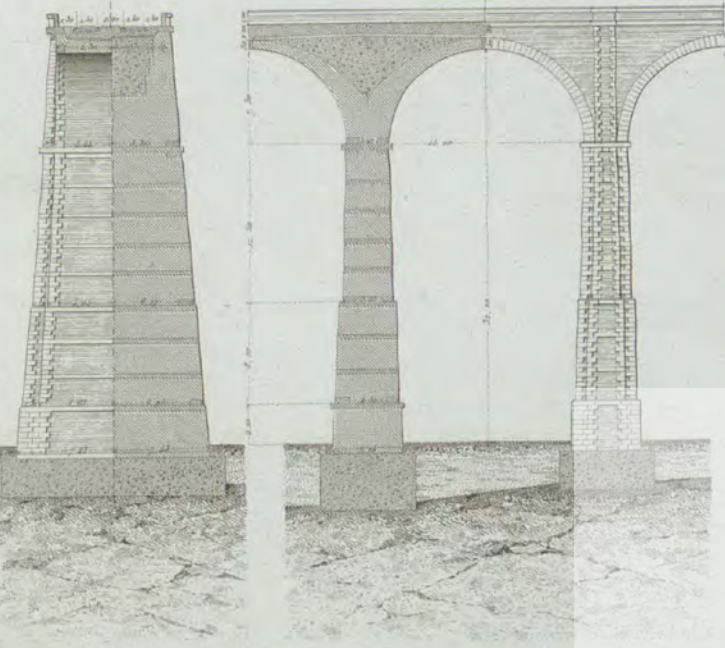

Fig. 16. Viaduc de Dinan.



Fig. 17. Viaduc du Val-Fleury.

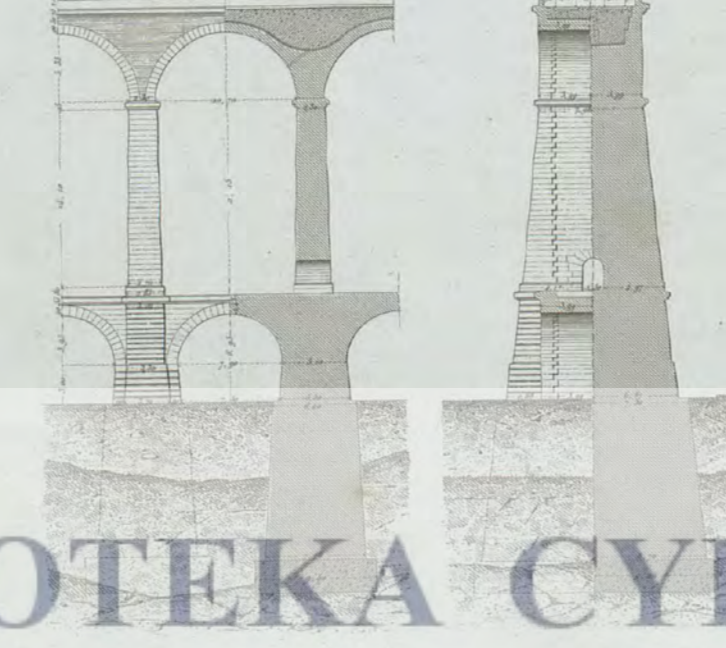

Fig. 18. Viaduc de la Combe-Boucard.



Fig. 19. Viaduc de la Fure.

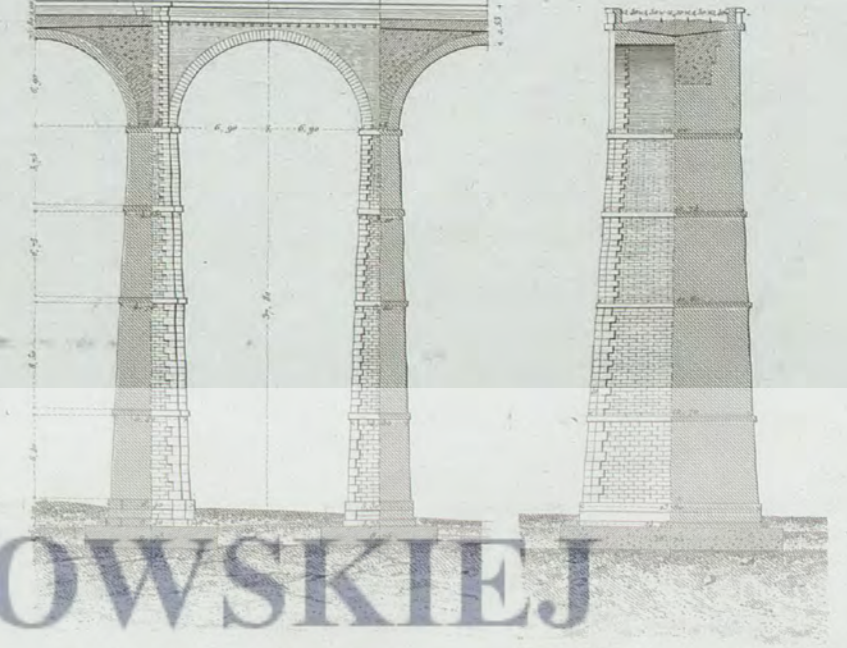

Fig. 20. Viaduc de Mirville.



BIBLIOTEKA CYFROWA POLITECHNIKI KRAKOWSKIEJ

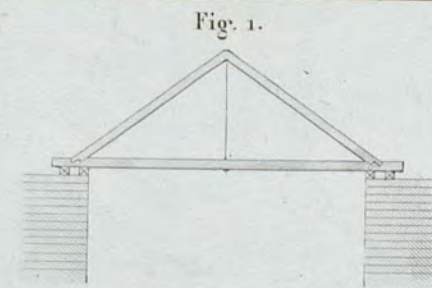

Fig. 1.

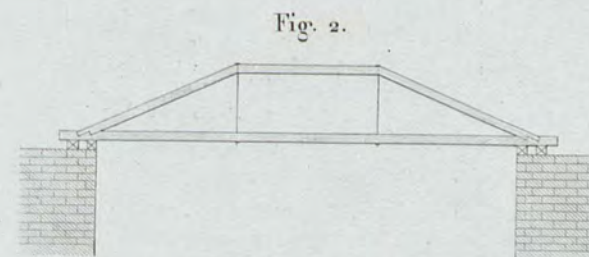

Fig. 2.

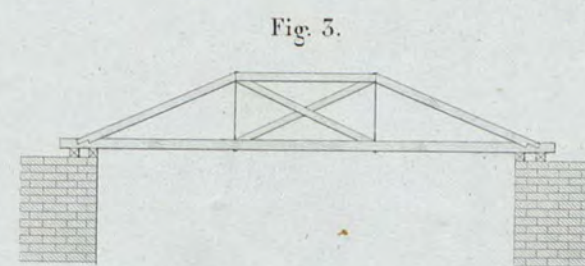

Fig. 3.

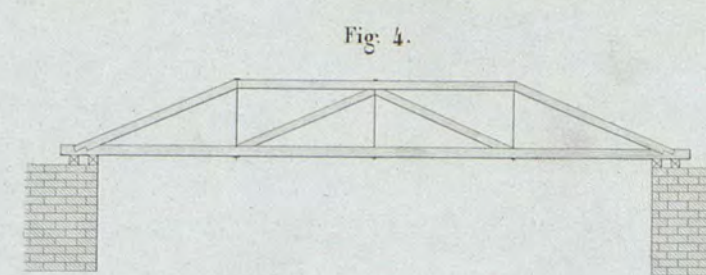

Fig. 4.



Fig. 5. Pont du Nicker

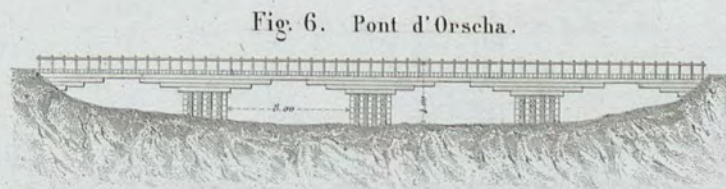

Fig. 6. Pont d'Orscha.

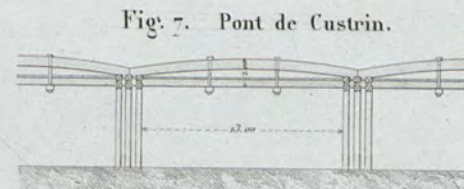

Fig. 7. Pont de Custrin.



Fig. 8. Estacade du Mourmelon.

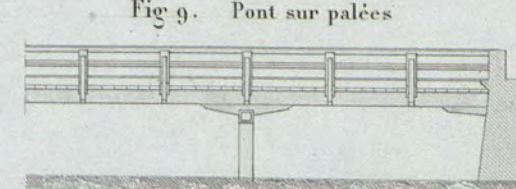

Fig. 9. Pont sur palées

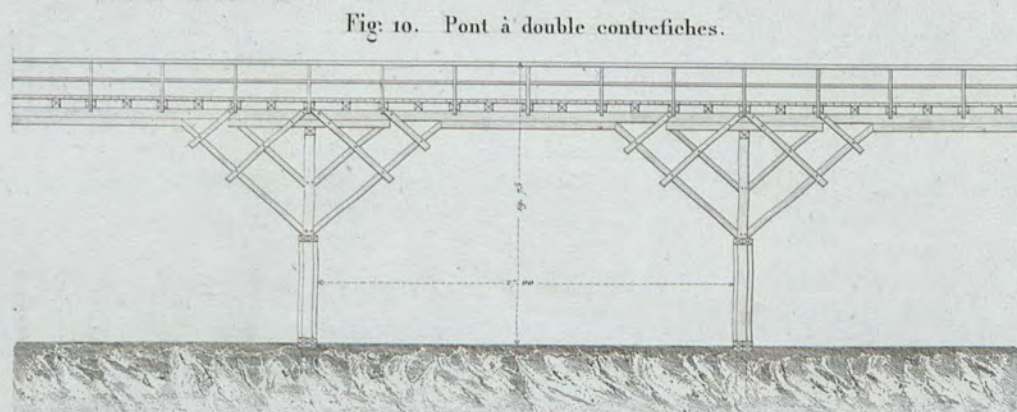

Fig. 10. Pont à double contrefiches.

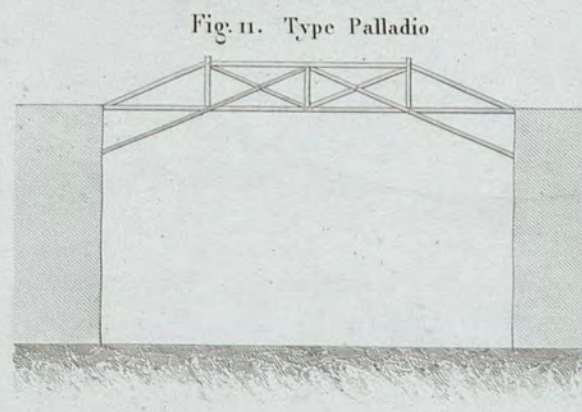

Fig. 11. Type Palladio

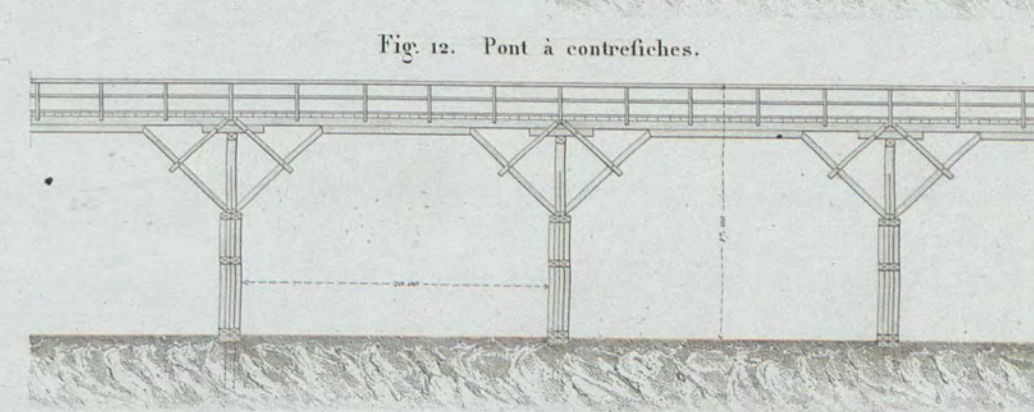

Fig. 12. Pont à contrefiches.

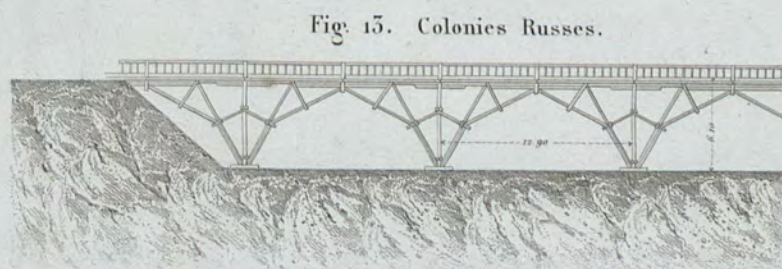

Fig. 13. Colonies Russes.

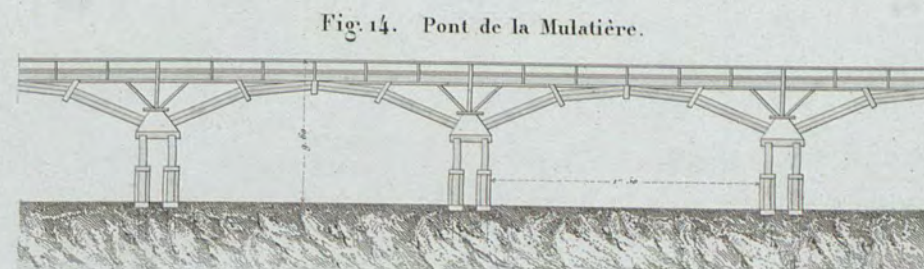

Fig. 14. Pont de la Mulatière.

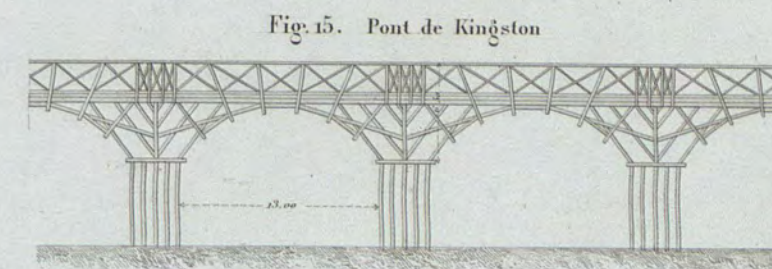

Fig. 15. Pont de Kingston

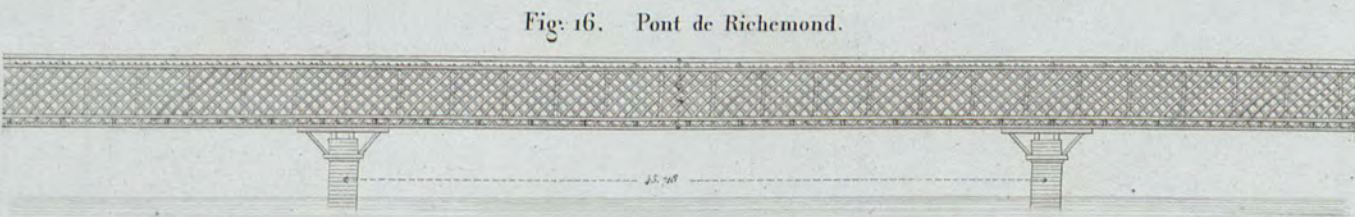

Fig. 16. Pont de Richemond.

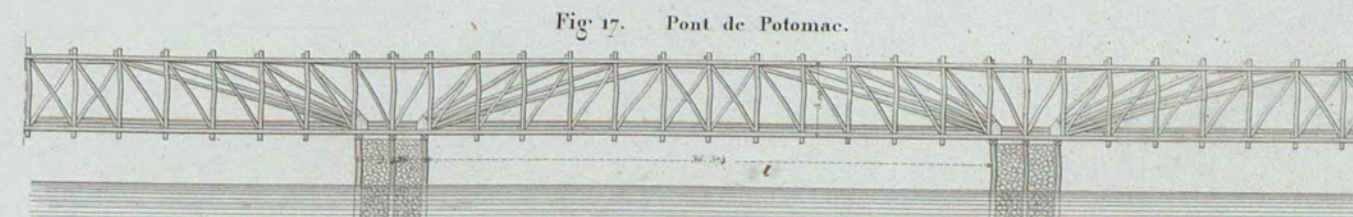

Fig. 17. Pont de Potomac.

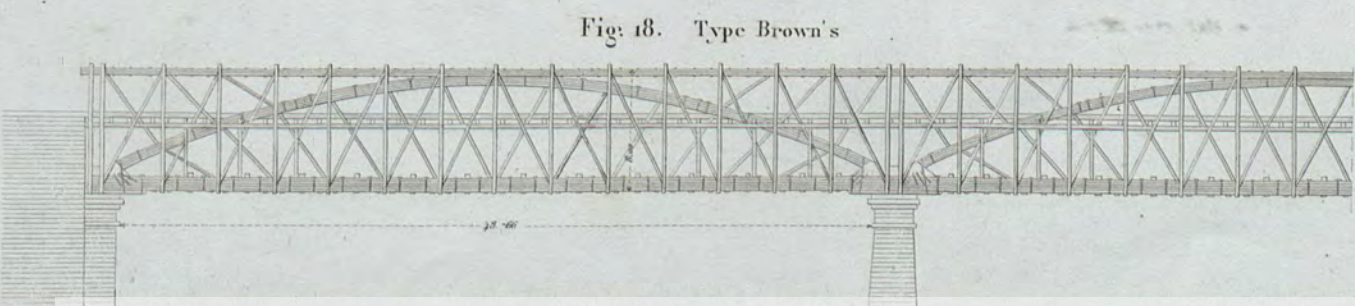

Fig. 18. Type Brown's

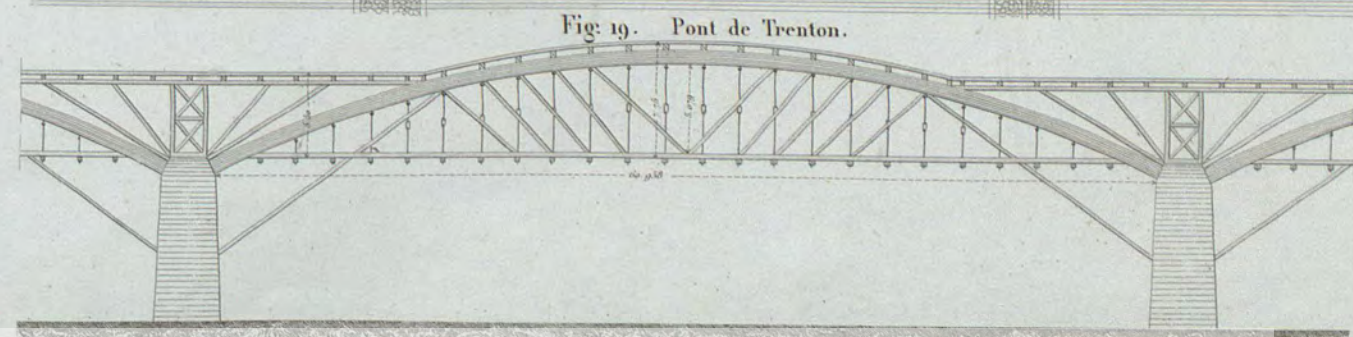

Fig. 19. Pont de Trenton.



Fig. 1. Pont sur la Mehaga.  
(Colonies Russes)



Fig. 2. Pont de Schaffouse.



Fig. 5. Pont de Bamberg.



Fig. 5. Pont de Bellow-Falls.

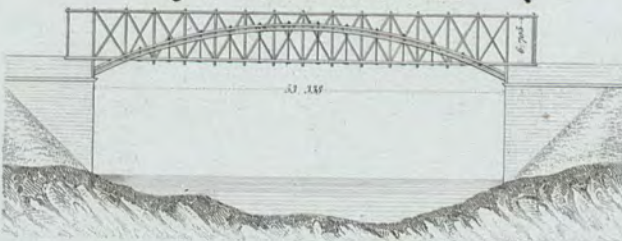

Fig. 6. Pont de Kempten.

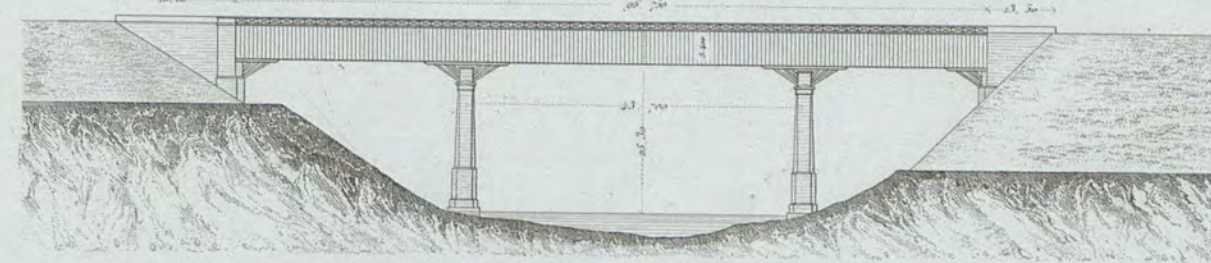

Fig. 7. Pont de Burlington.



Fig. 8. Pont de Chicapoë.

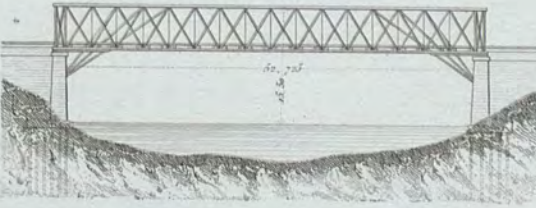

Fig. 9. Pont sur la Tweed.

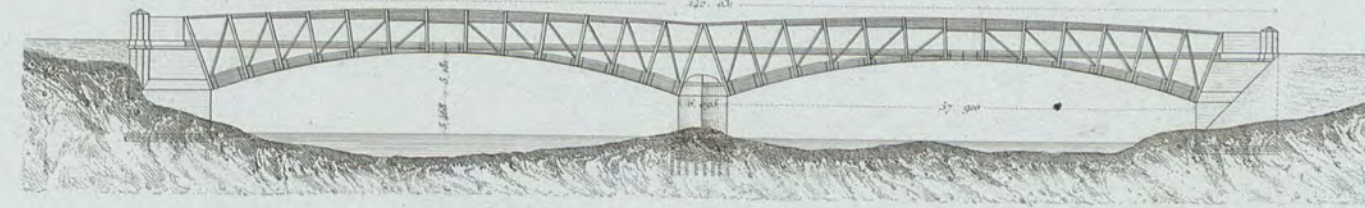

Fig. 10. Pont de Zurich.



Fig. 11. Pont de l'Utica.



Fig. 12. Pont provisoire à Asnières.

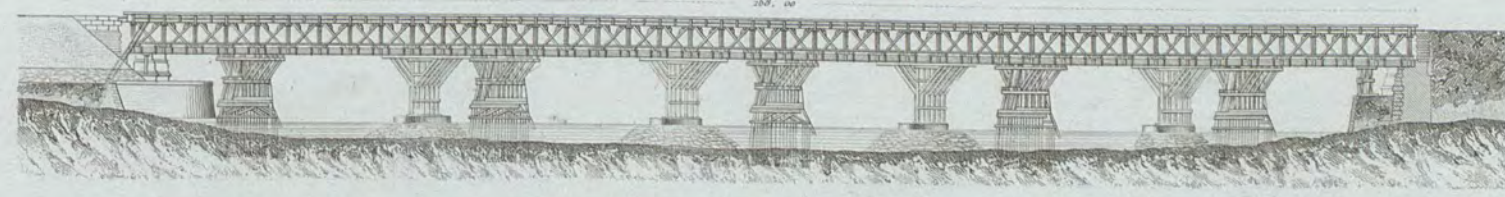

Fig. 13. Pont Américain sur le Canal de la Marne au Rhin.  
(Camp de Châlons)



Fig. 14. Pont de Besigheim.



Fig. 15. Viaduc sur la Moorswater.

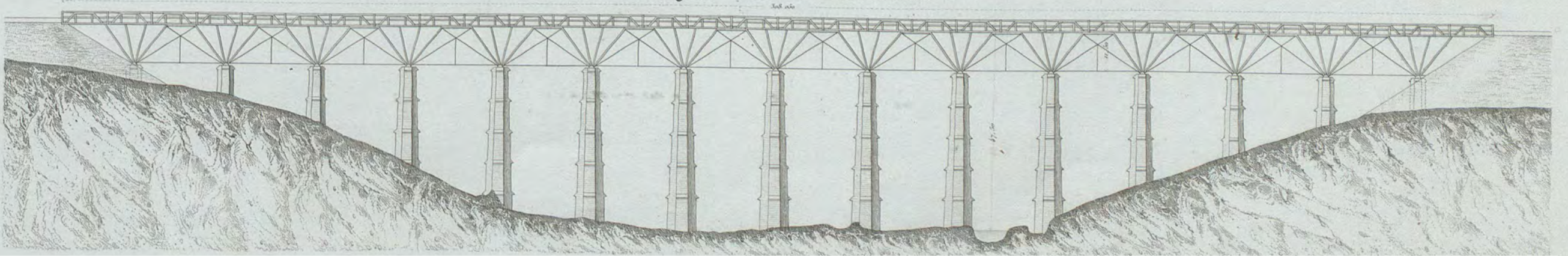

Fig. 1. Pont de Peacock

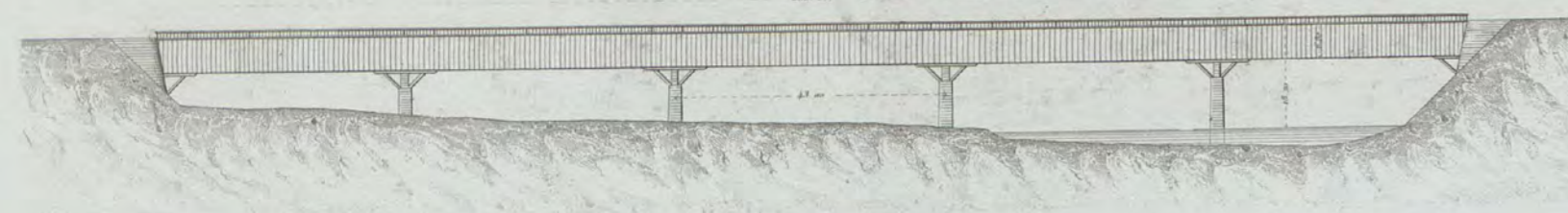

Fig. 2. Viaduc de Willington



Fig. 3. Pont de Scotswood

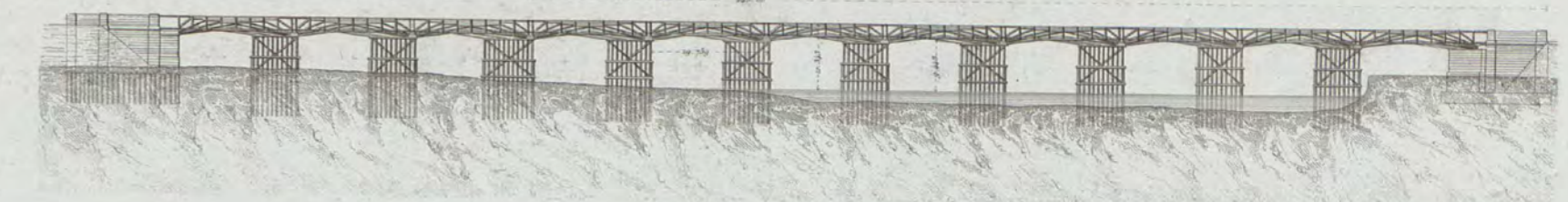

Fig. 4. Pont sur la rivière l'Etherow

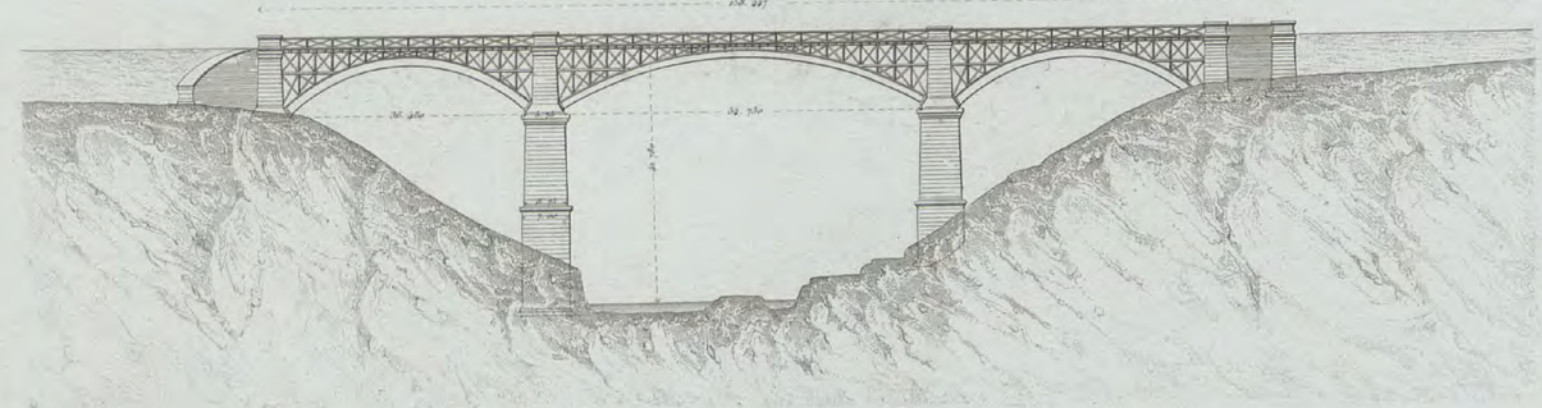

Fig. 5. Pont du Haut-Portage

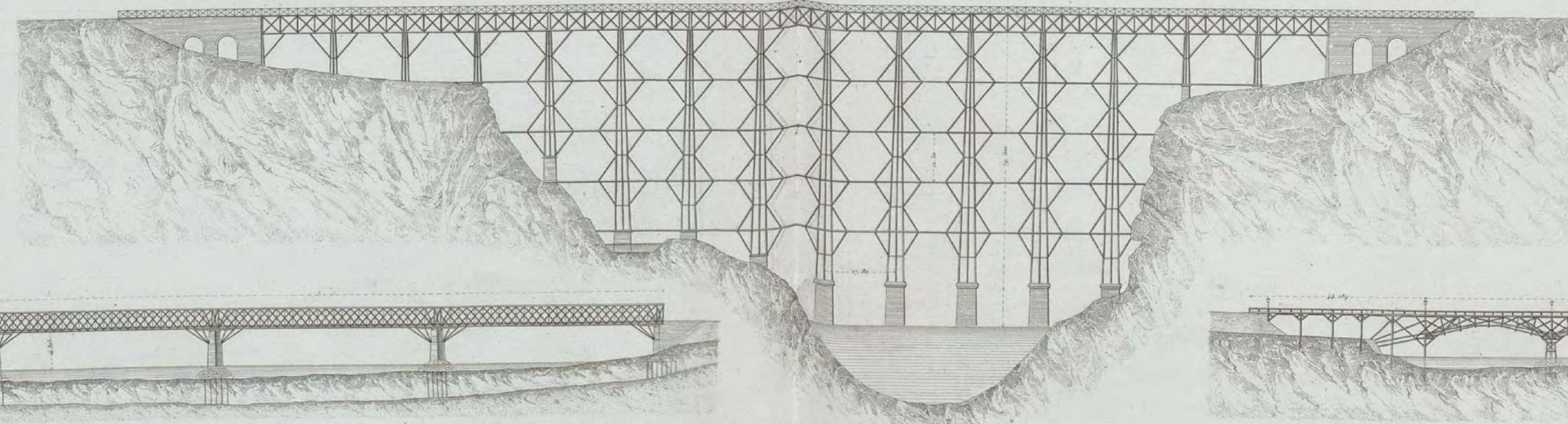

Fig. 6. Pont de Cascade Glen

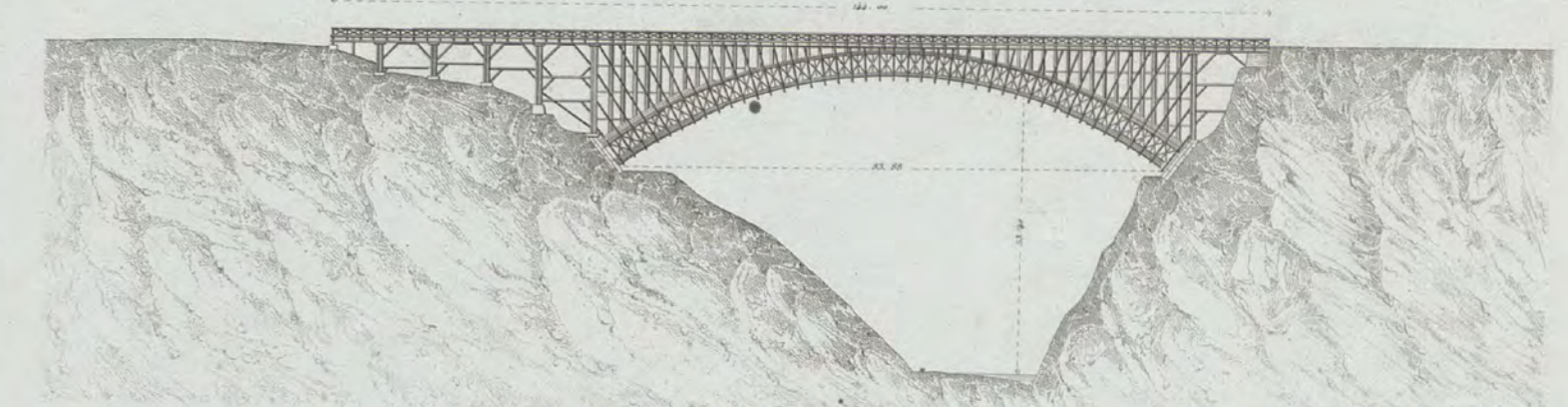

Fig. 7. Pont sur le Connecticut

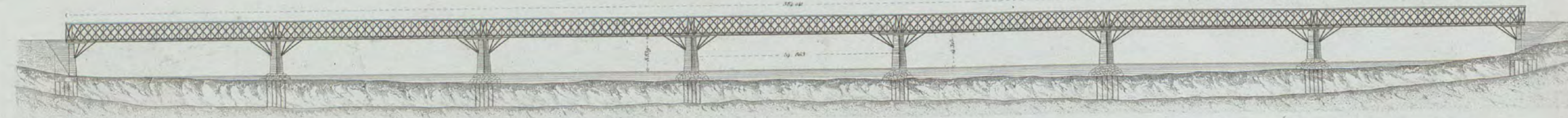

Fig. 8. Pont provisoire sur le Neckar



Fig. 9. Pont du Cornwall

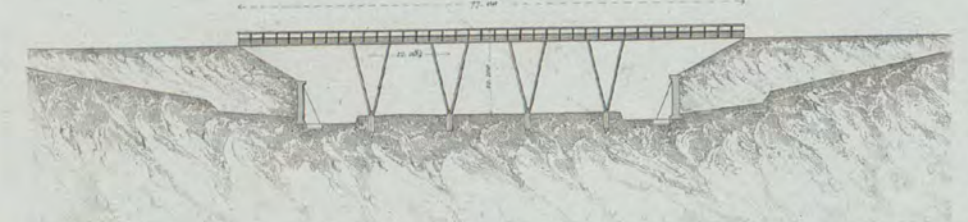

Fig. 10. Viaduc de Landore



Fig. 11. Pont sur la Murg



Fig. 12. Pont de Waltenhofer-Bach



Fig. 13. Pont sur la Msta



Fig. 14. Pont de Bandon



BIBLIOTEKA CYFROWA POLITECHNIKI KRAKOWSKIEJ

Echelle 1/1000 pour 1 mètre

Fig. 1. Pont sur le Dirschau.

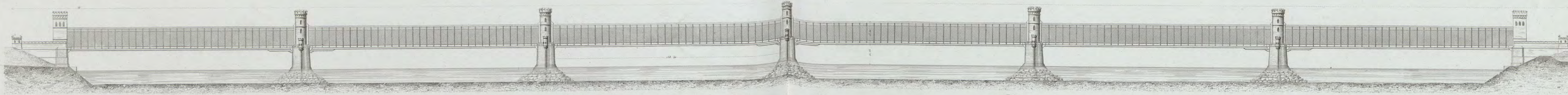

Fig. 2. Pont du viaduc de la Boyne.

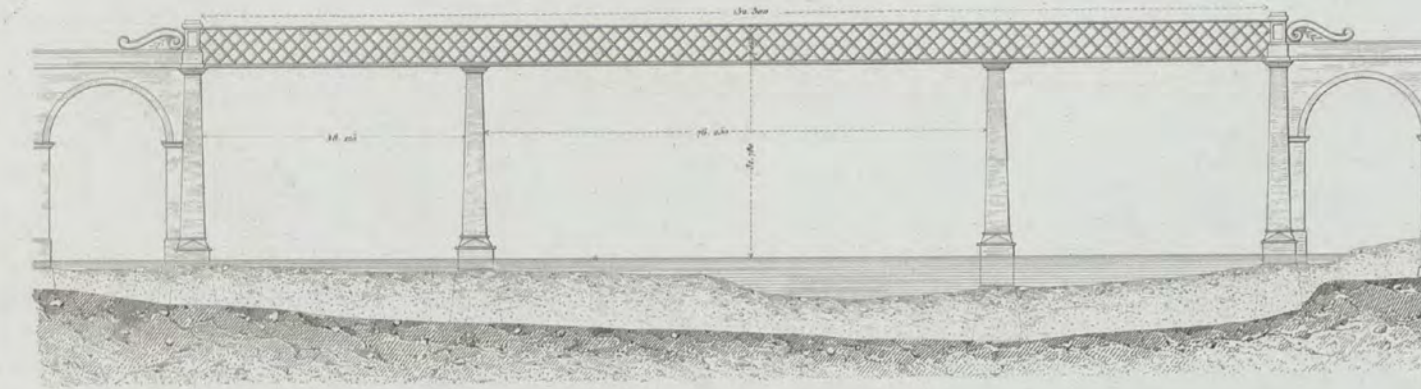

Fig. 3. Pont du Niagara.



Fig. 4. Pont sur l'Aar.

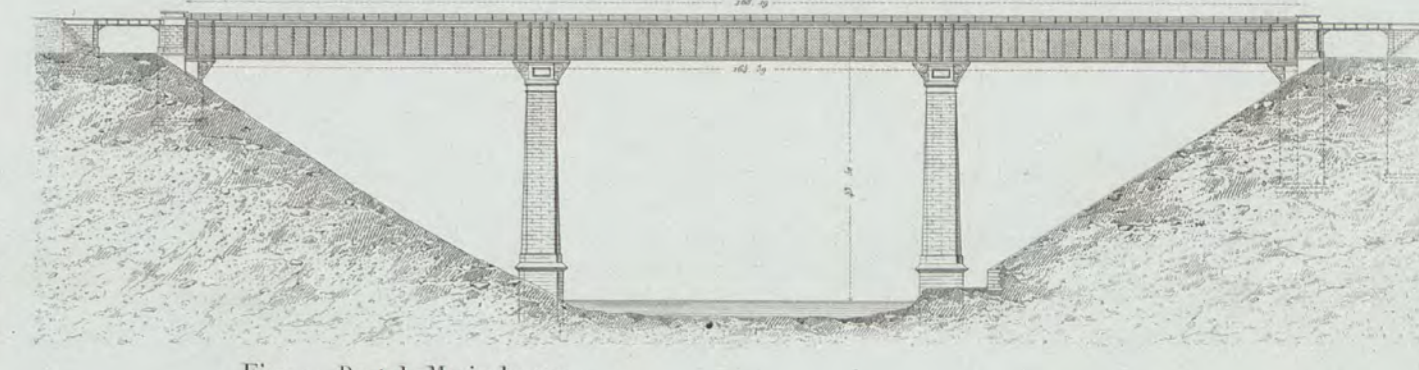

Fig. 5. Pont sur la Saône.

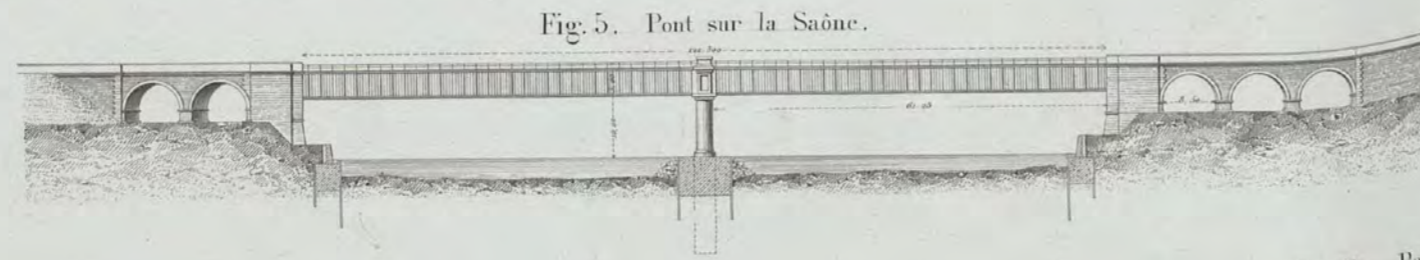

Fig. 6. Pont d'Asnières.



Fig. 9. Pont de Marienbourg.

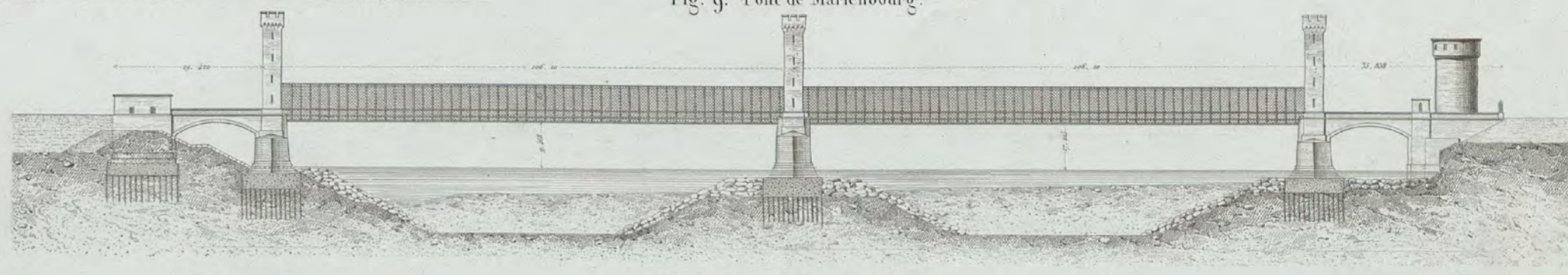

Fig. 7. Pont de Langon.



Fig. 8. Pont sur la Sitter.

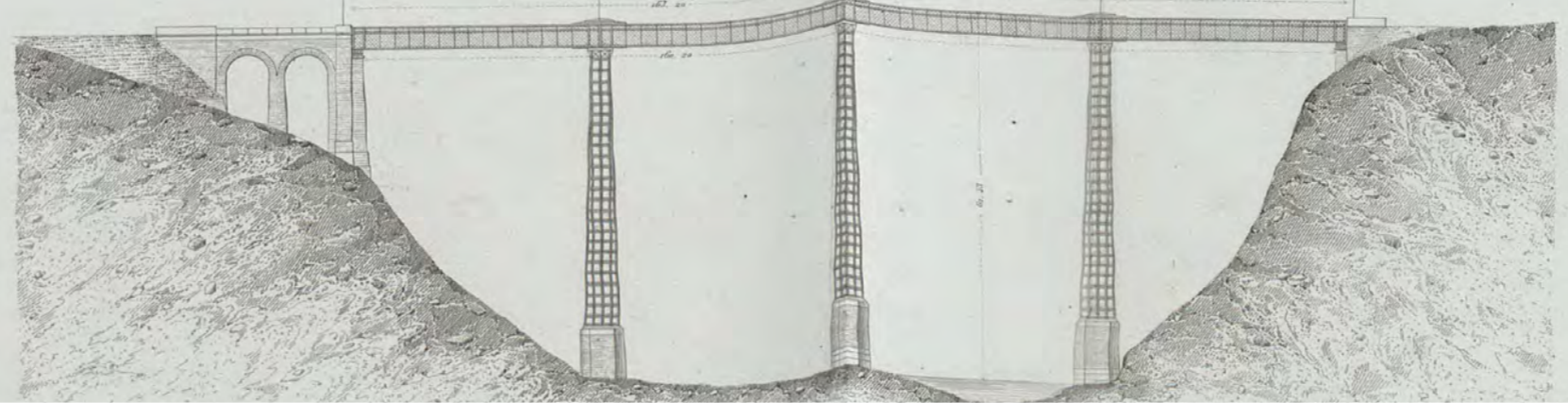

Fig. 10. Pont du Liestal.



Fig. 11. Pont de Vina-del-Mar.



Fig. 12. Pont sur le Canal S' Denis.



Fig. 13. Pont de Chely.



Fig. 14. Pont de Backleed street à Londres.



Fig. 15. Pont du Cirou.



Fig. 16. Pont d'Arcole.



Fig. 17. Pont viaduc de Lunas.

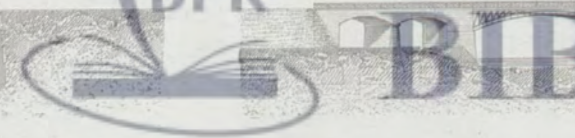

Fig. 18. Pont sur le Lac Atalia.



Fig. 19. Pont d'Offenbourg.

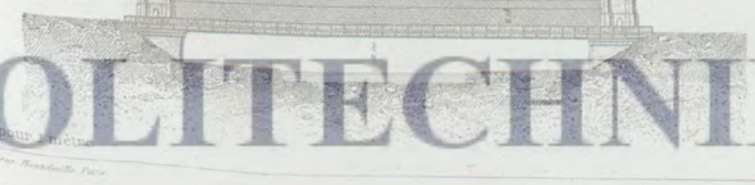

Fig. 20. Pont de Rëgensburg.



Fig. 21. Pont de Windsor.



BIBLIOTEKA CYFROWA POLITECHNIKI KRAKOWSKIEJ



Détails des ponts en fer.

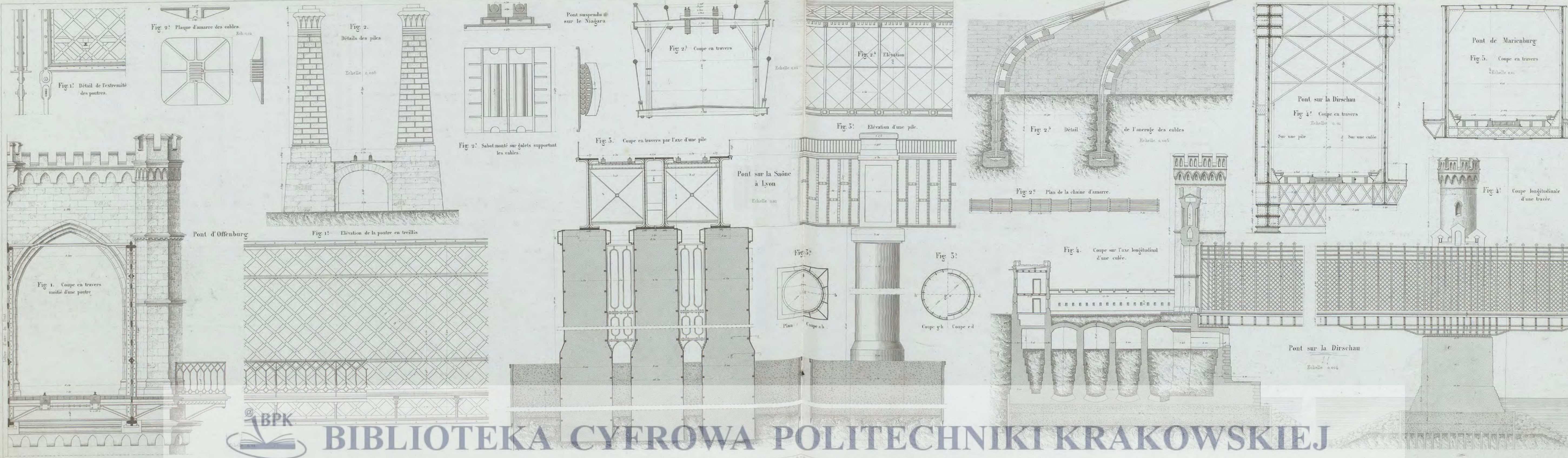

BIBLIOTEKA CYFROWA POLITECHNIKI KRAKOWSKIEJ

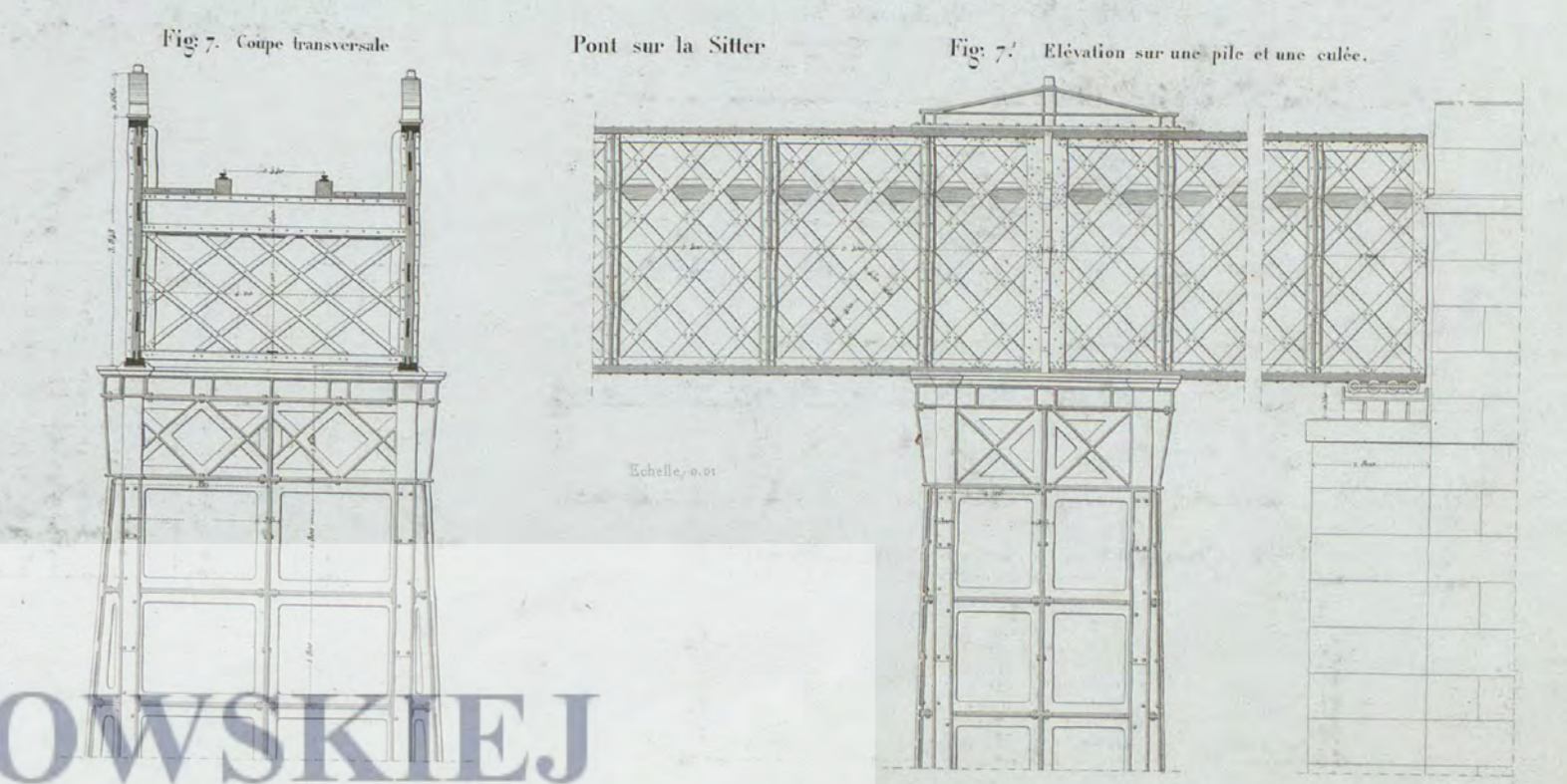
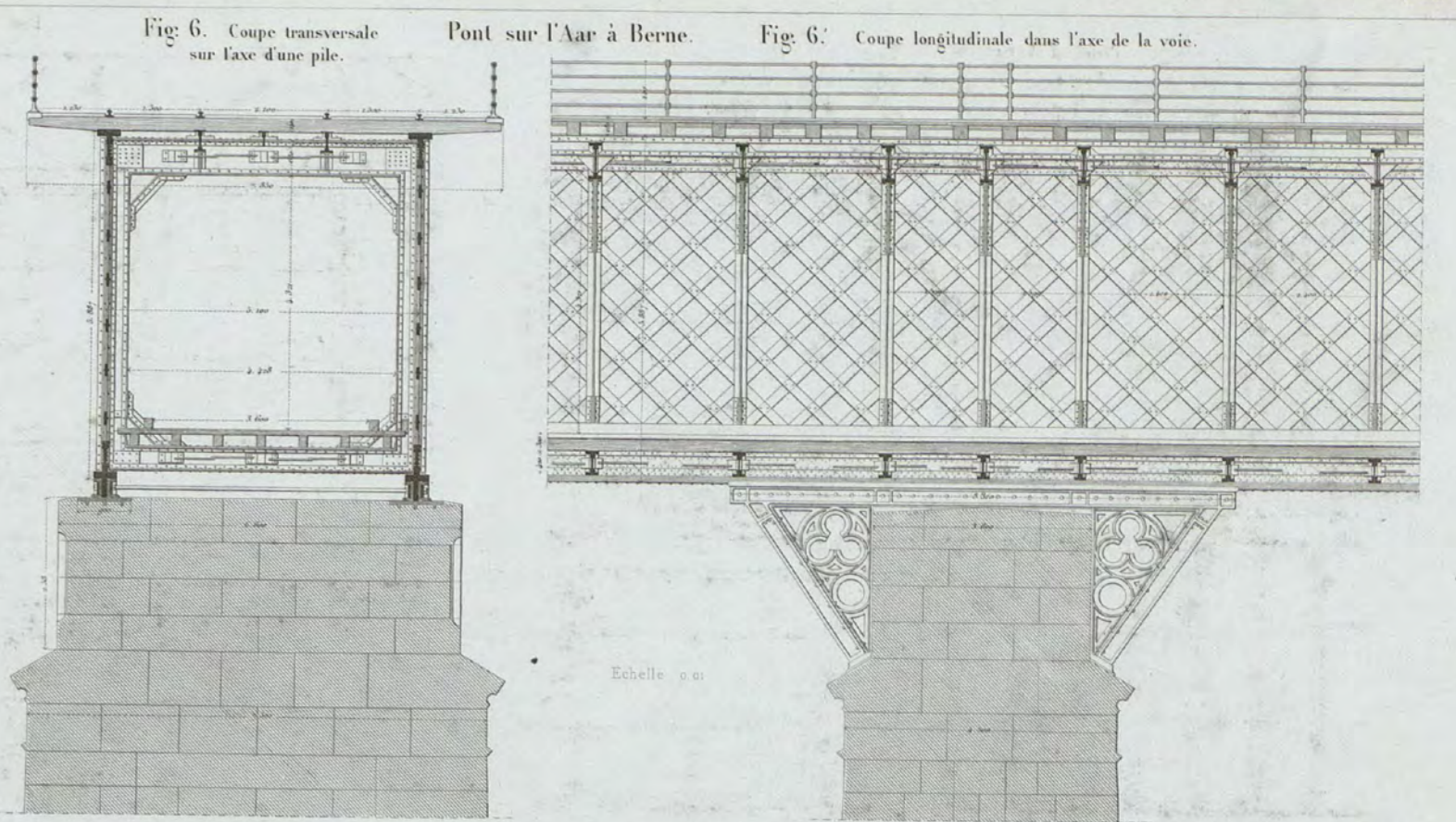
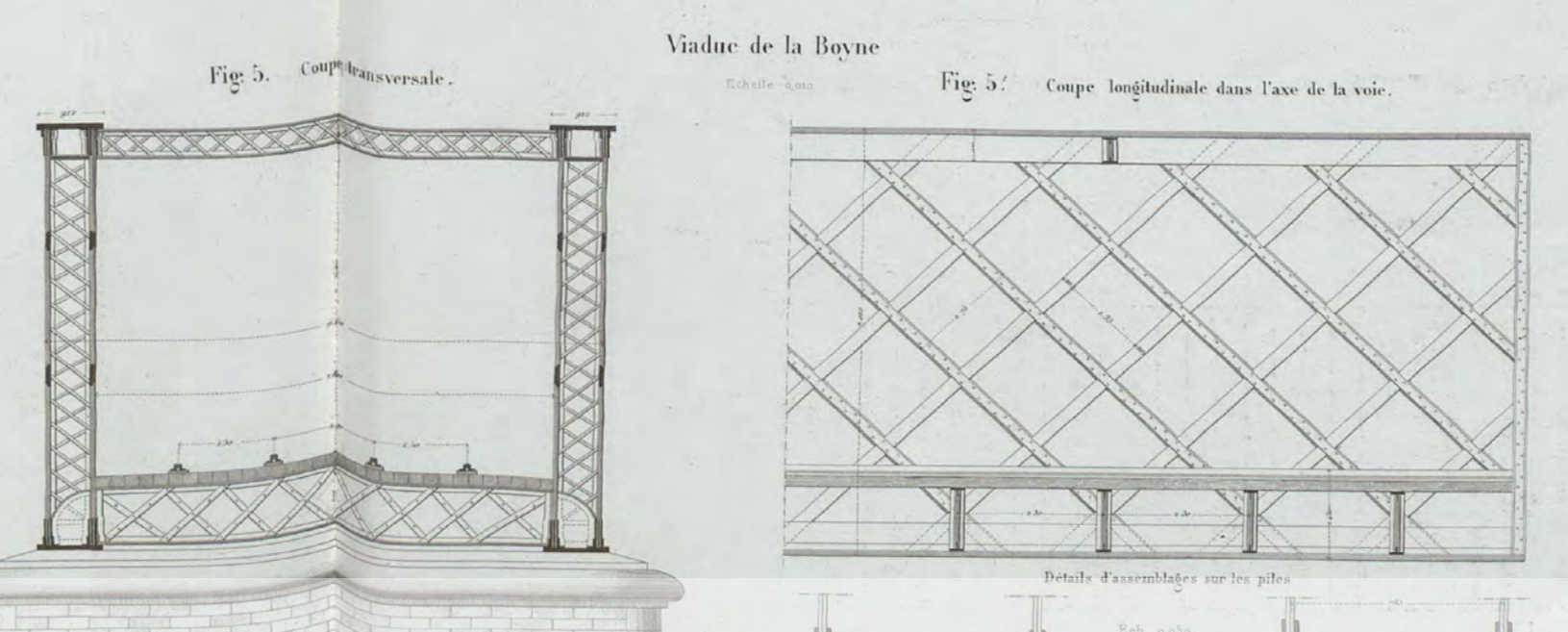
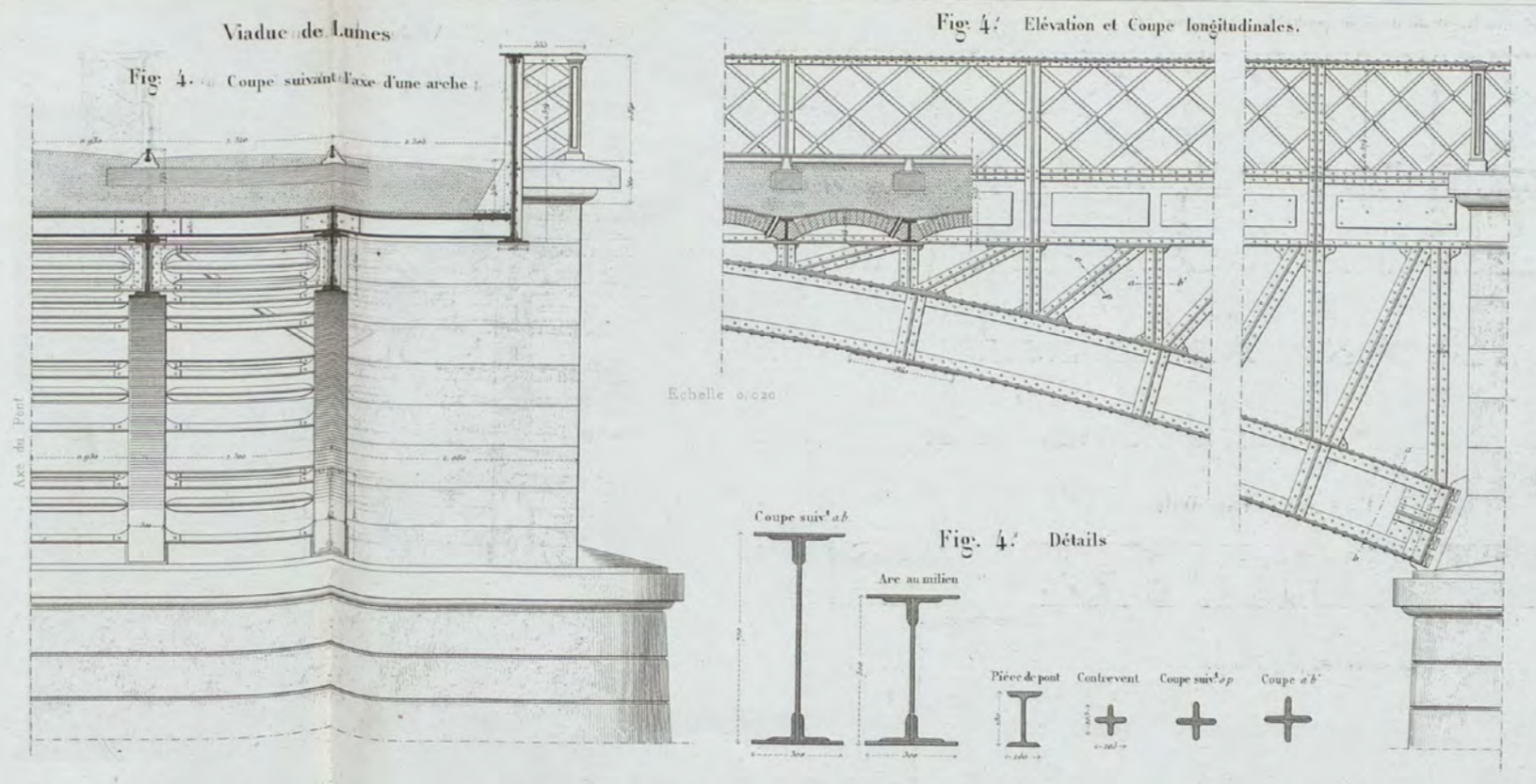
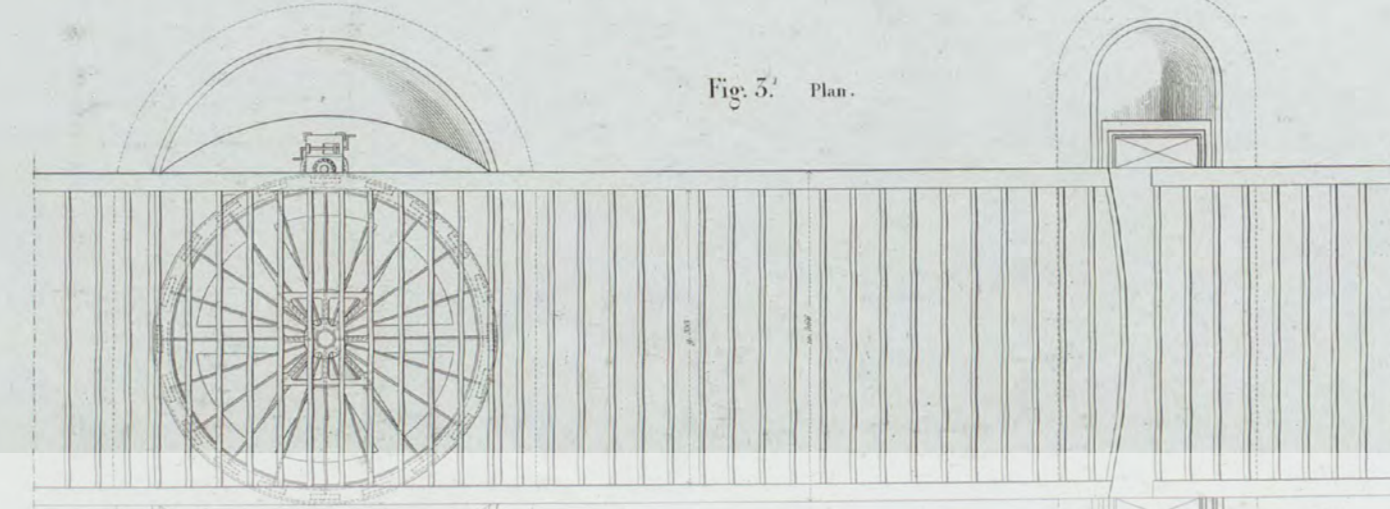
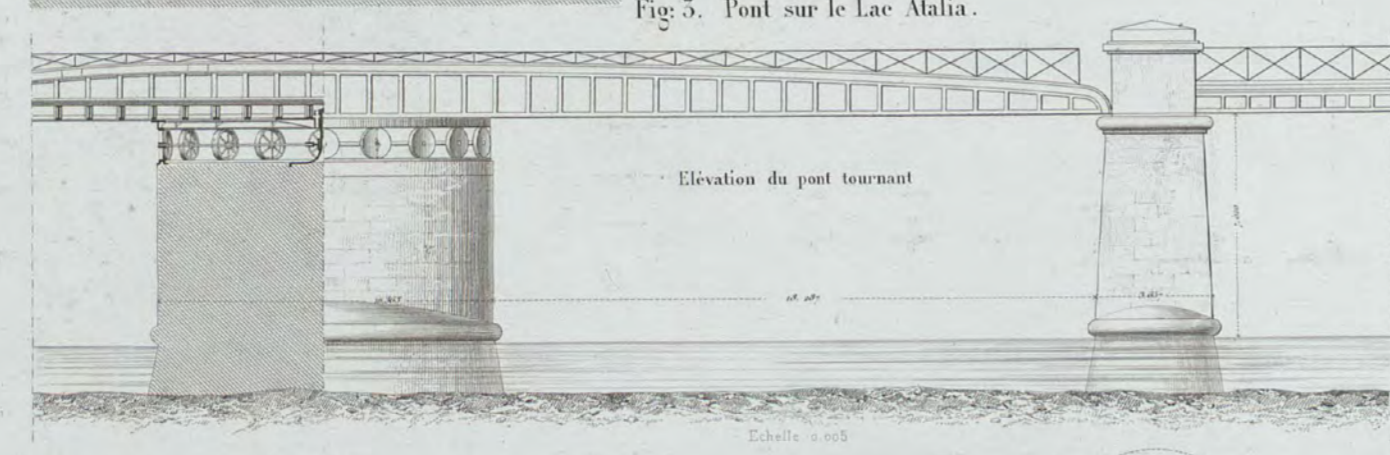
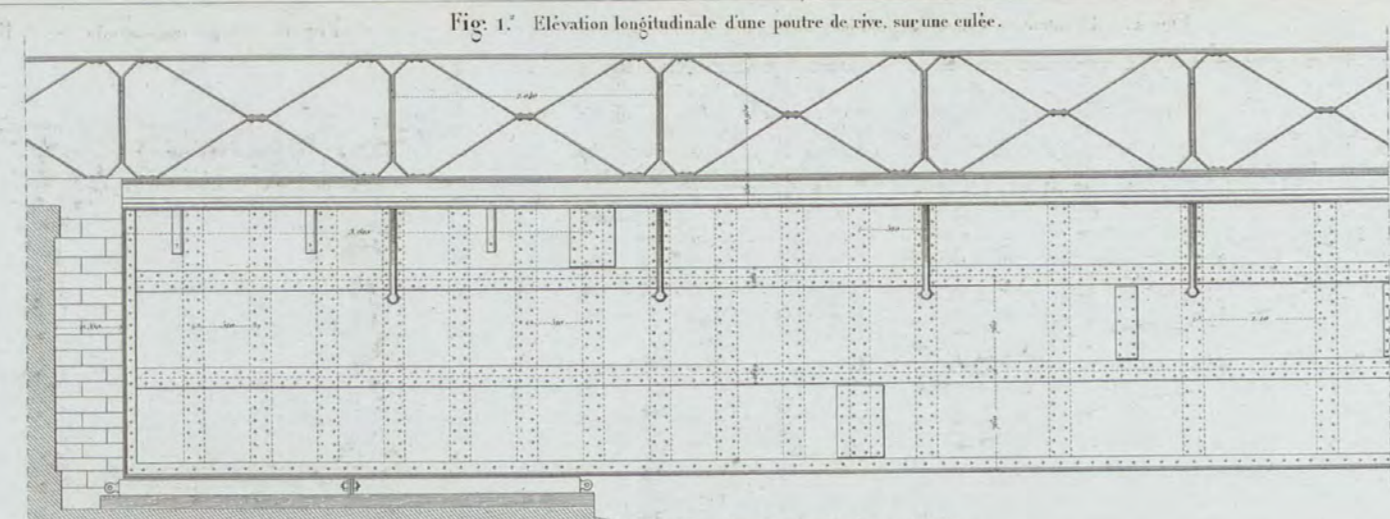
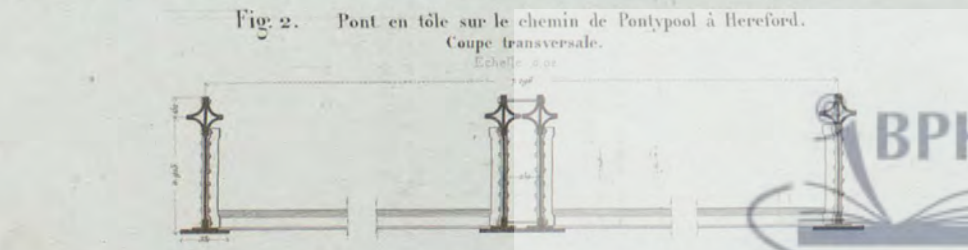
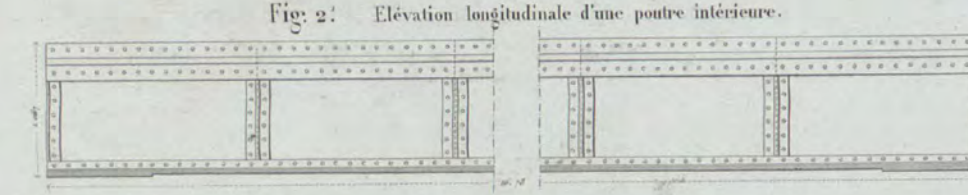
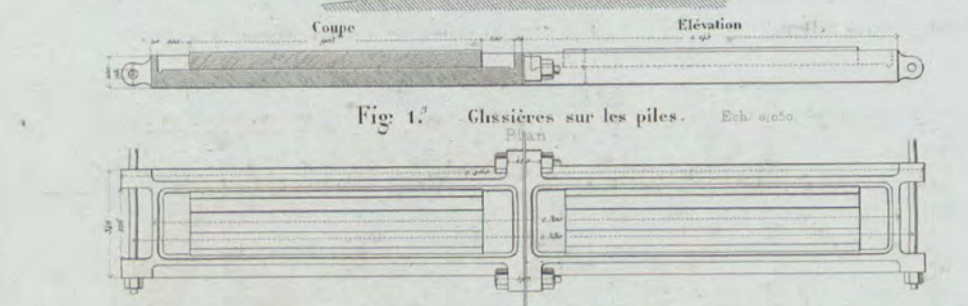
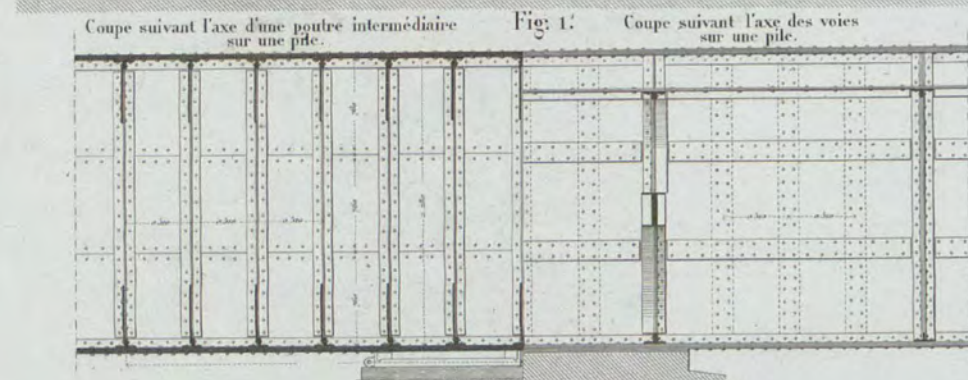
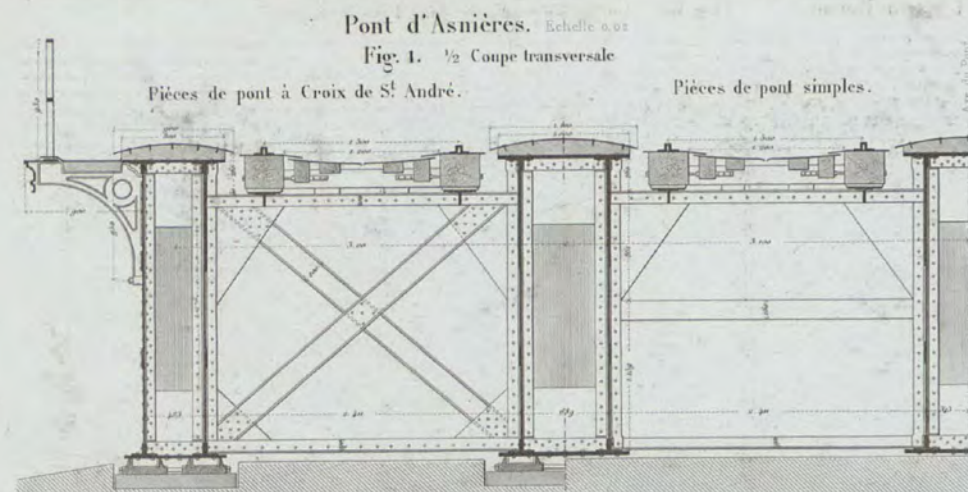

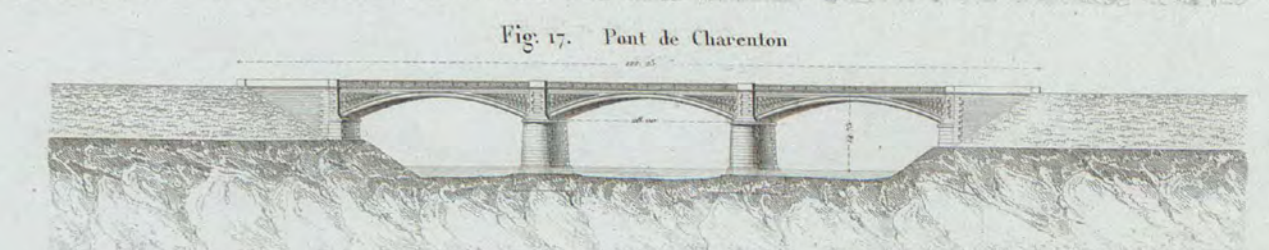
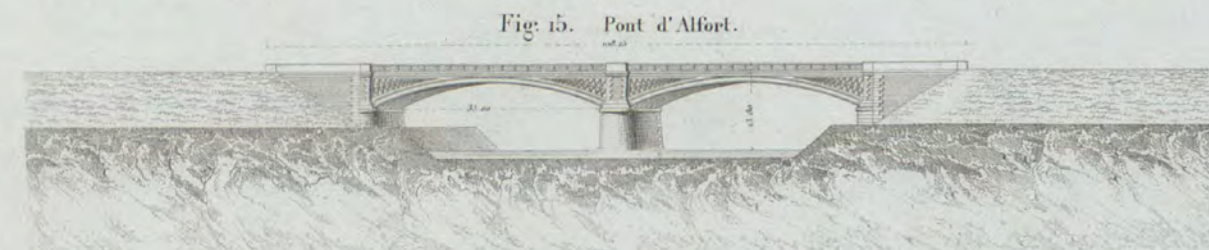
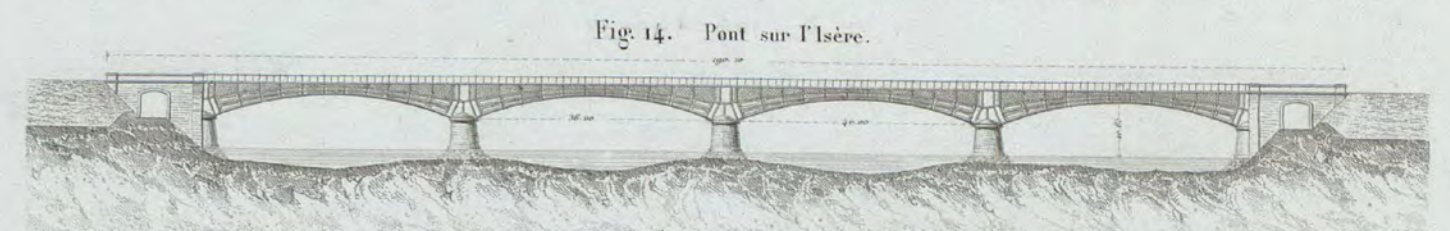
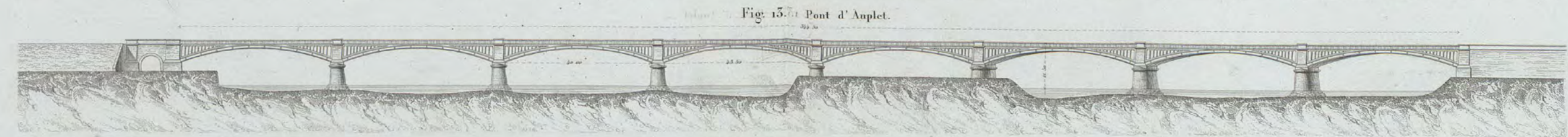
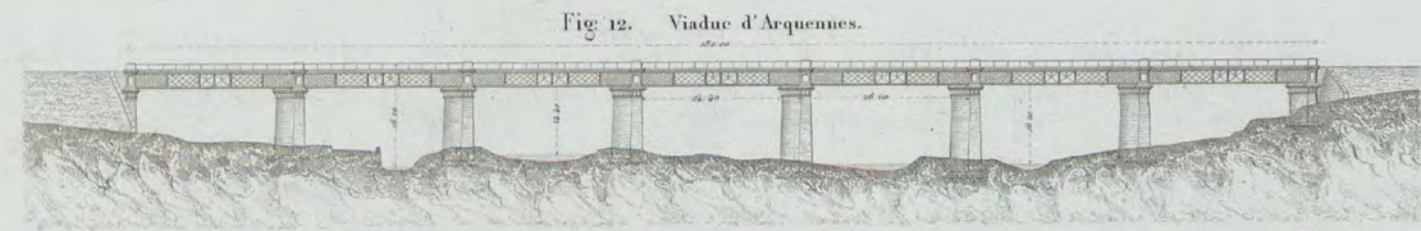
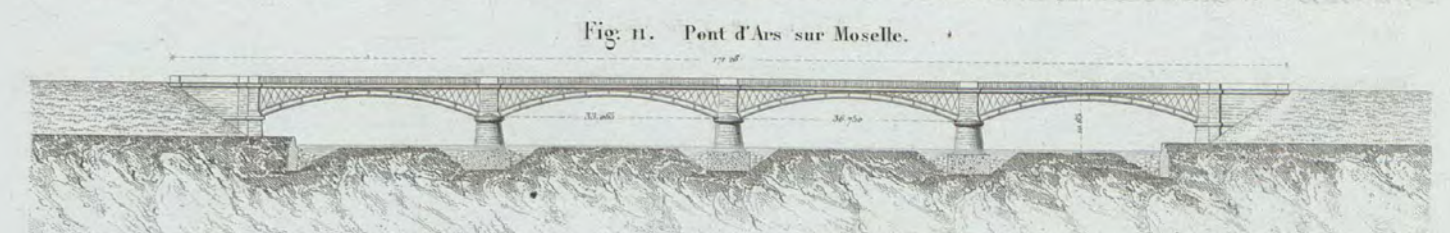
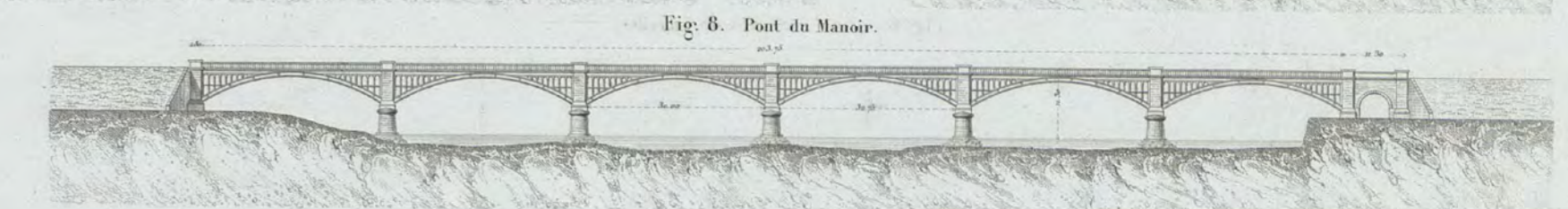
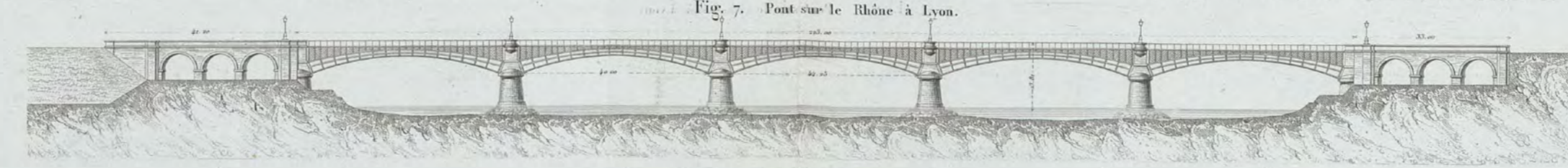
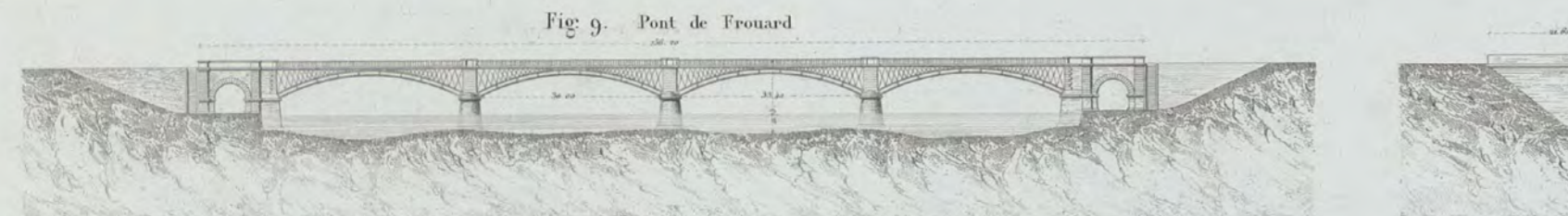
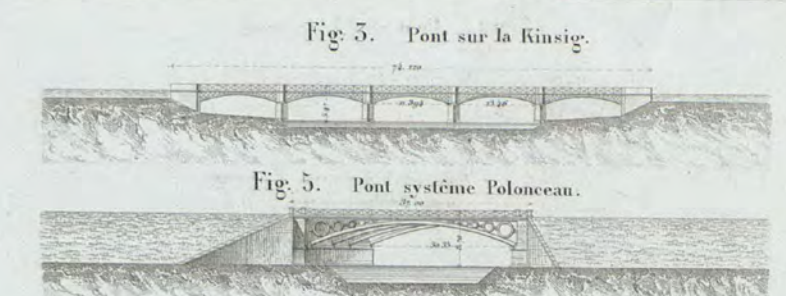

BIBLIOTEKA CYFROWA POLITECHNIKI KRAKOWSKIEJ

Echelle 1/5000 pour 1 mètre.

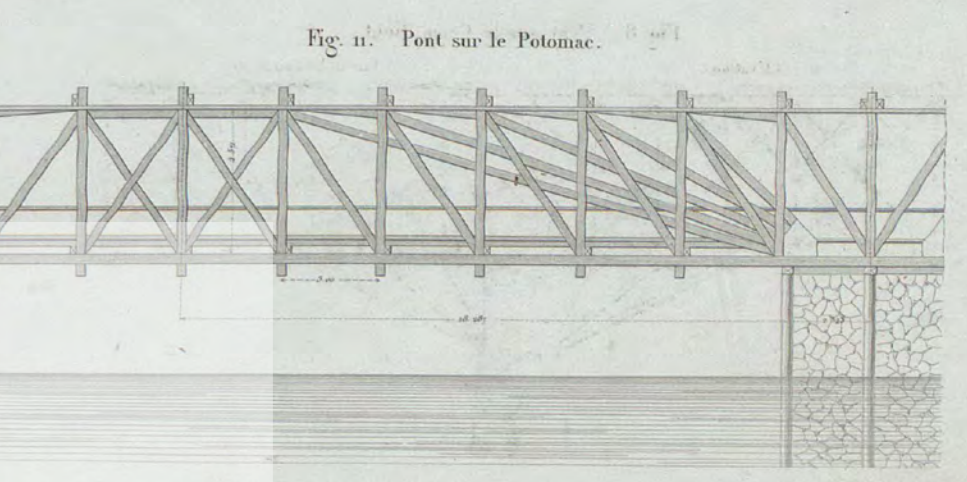
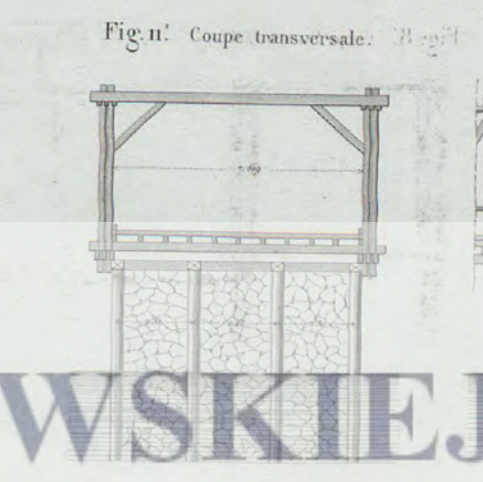
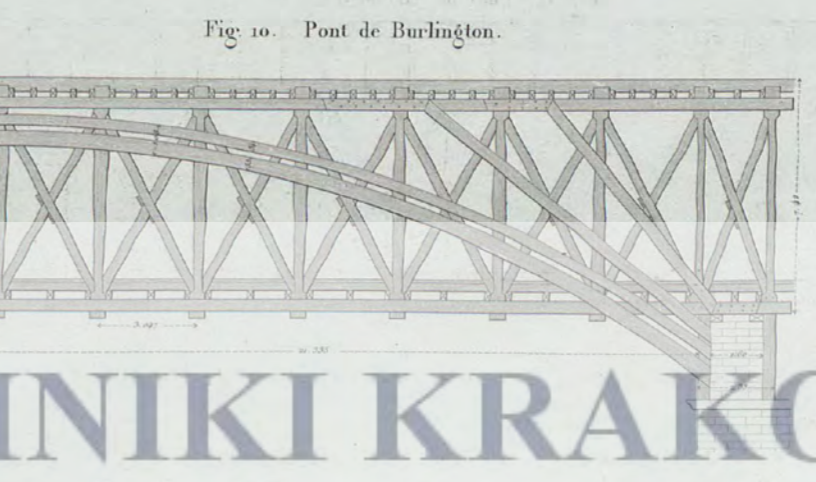
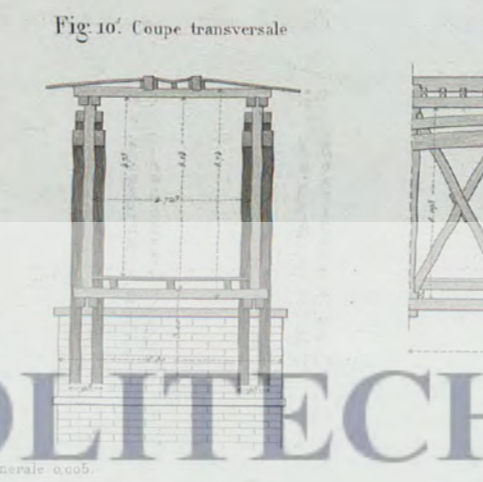
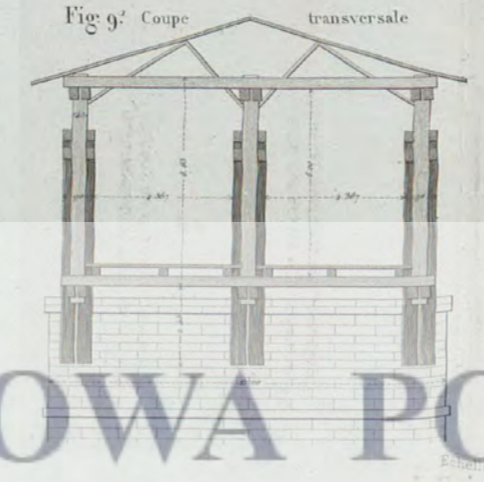
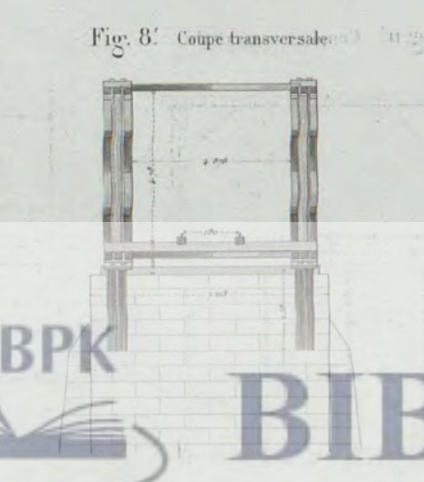
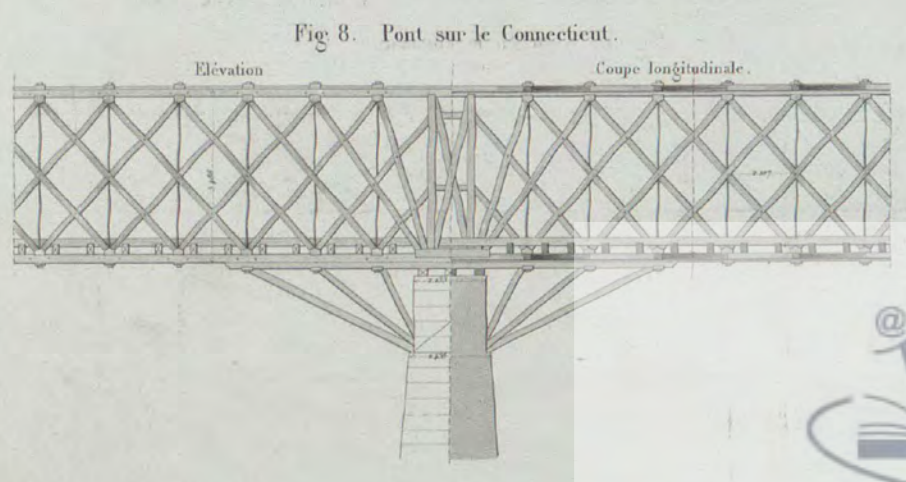
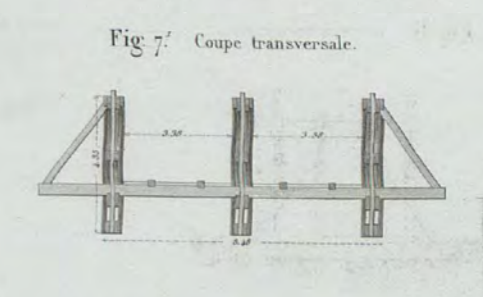
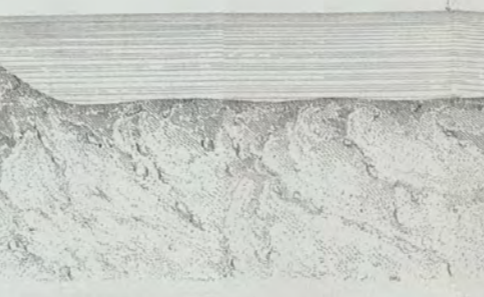
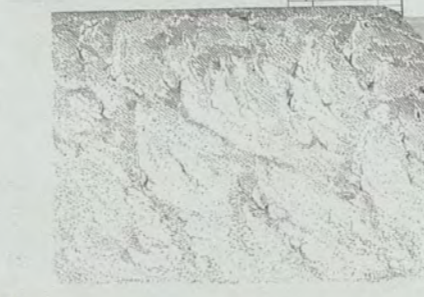
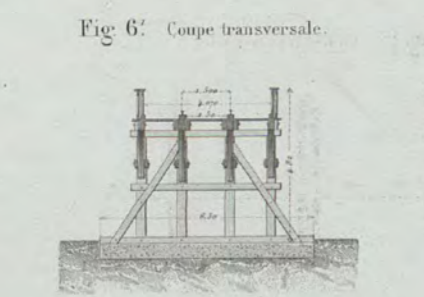
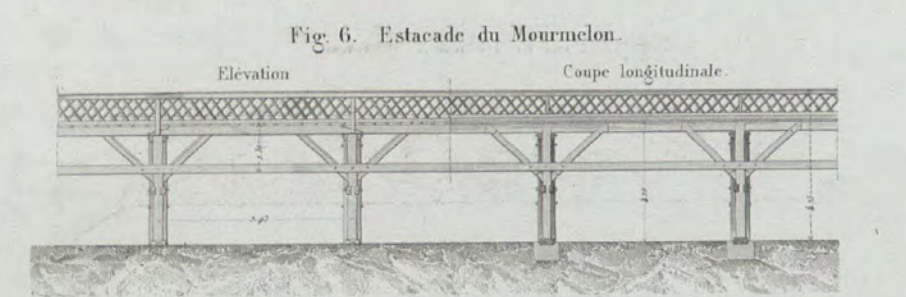
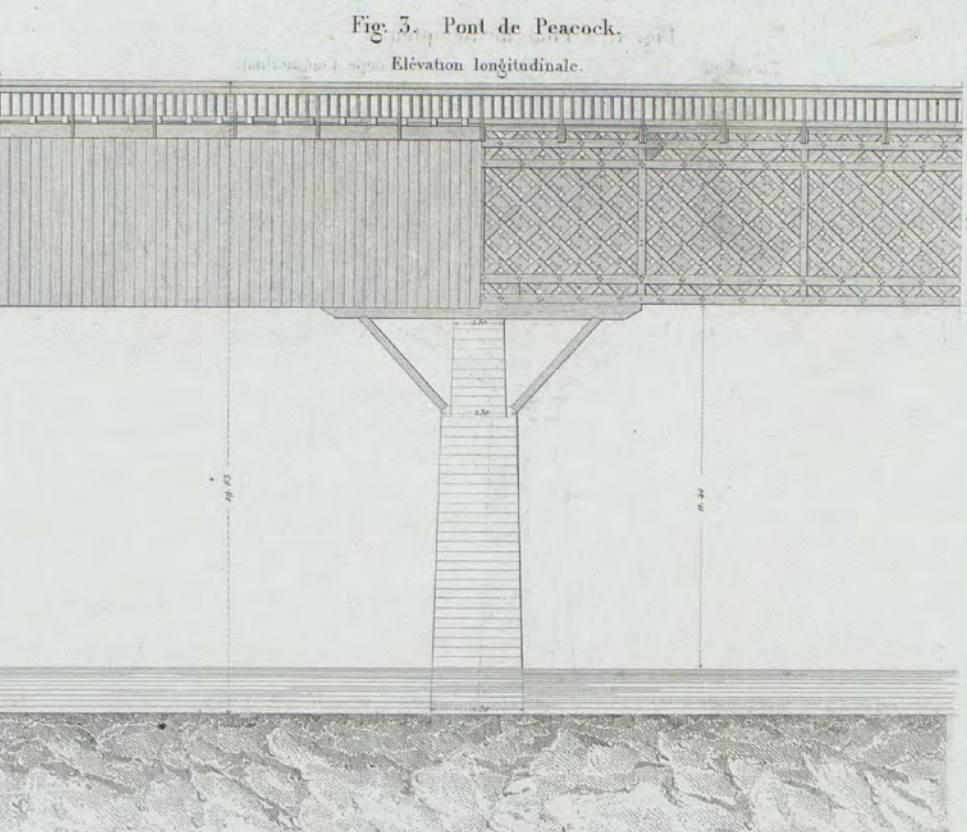
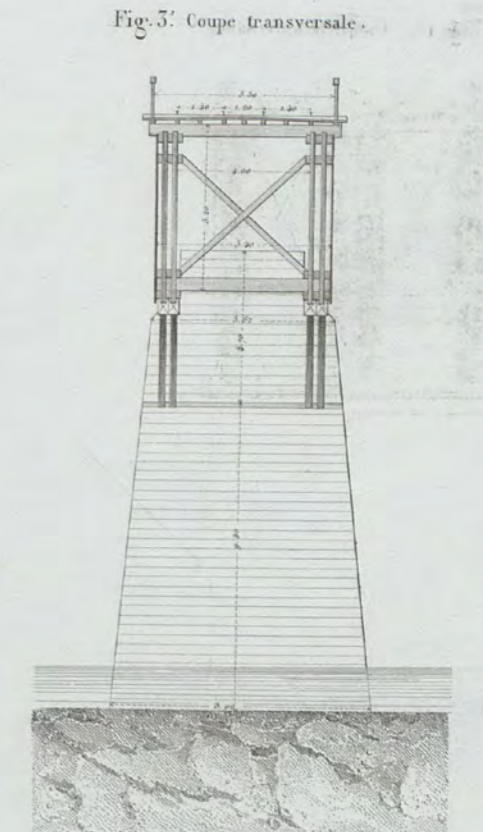
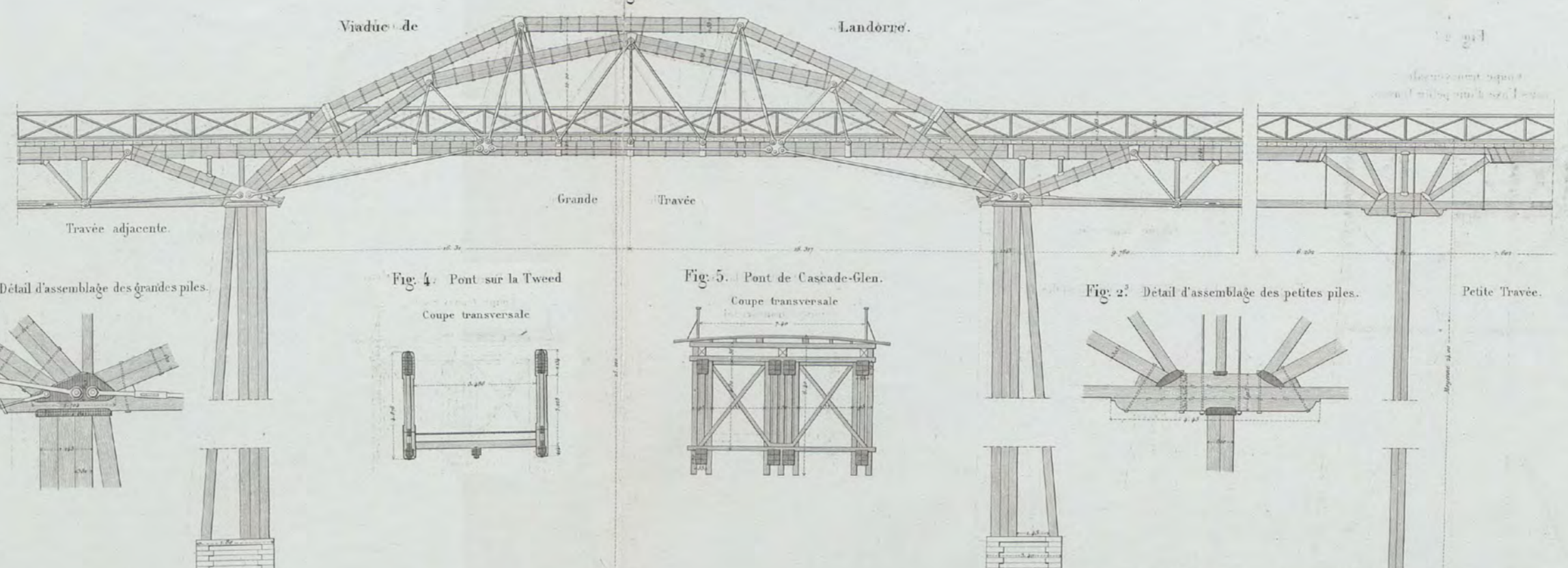
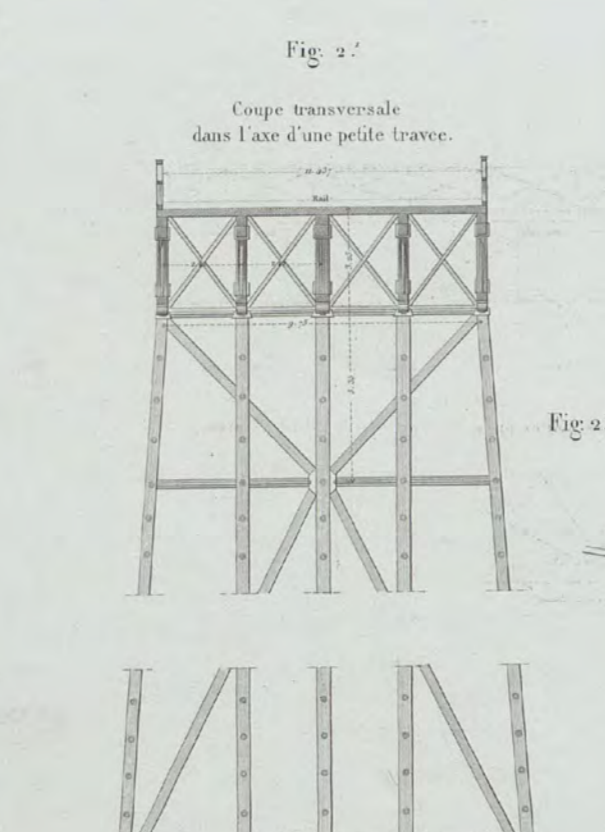
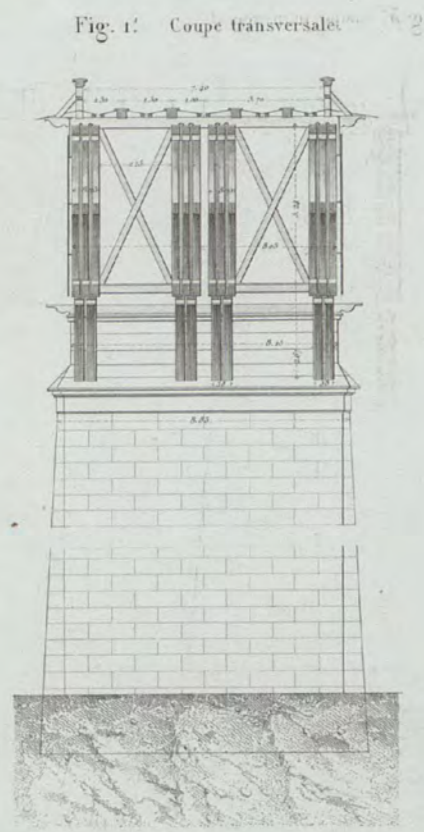
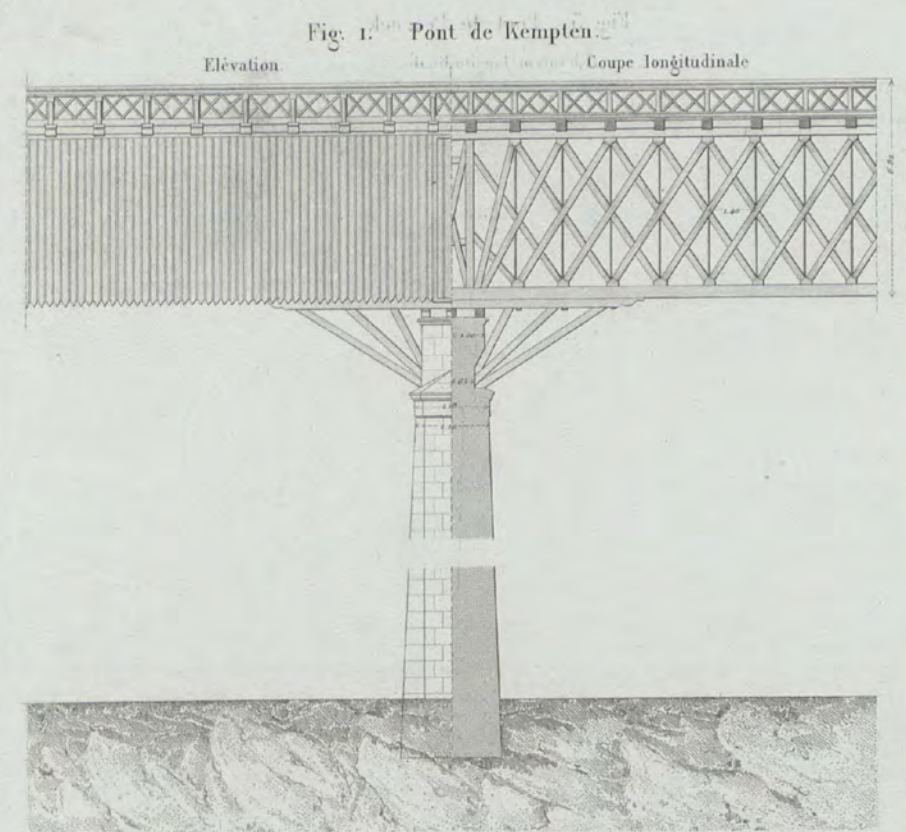

BIBLIOTEKA CYFROWA POLITECHNIKI KRAKOWSKIEJ

Fig. 1. Pont de Scotwood.

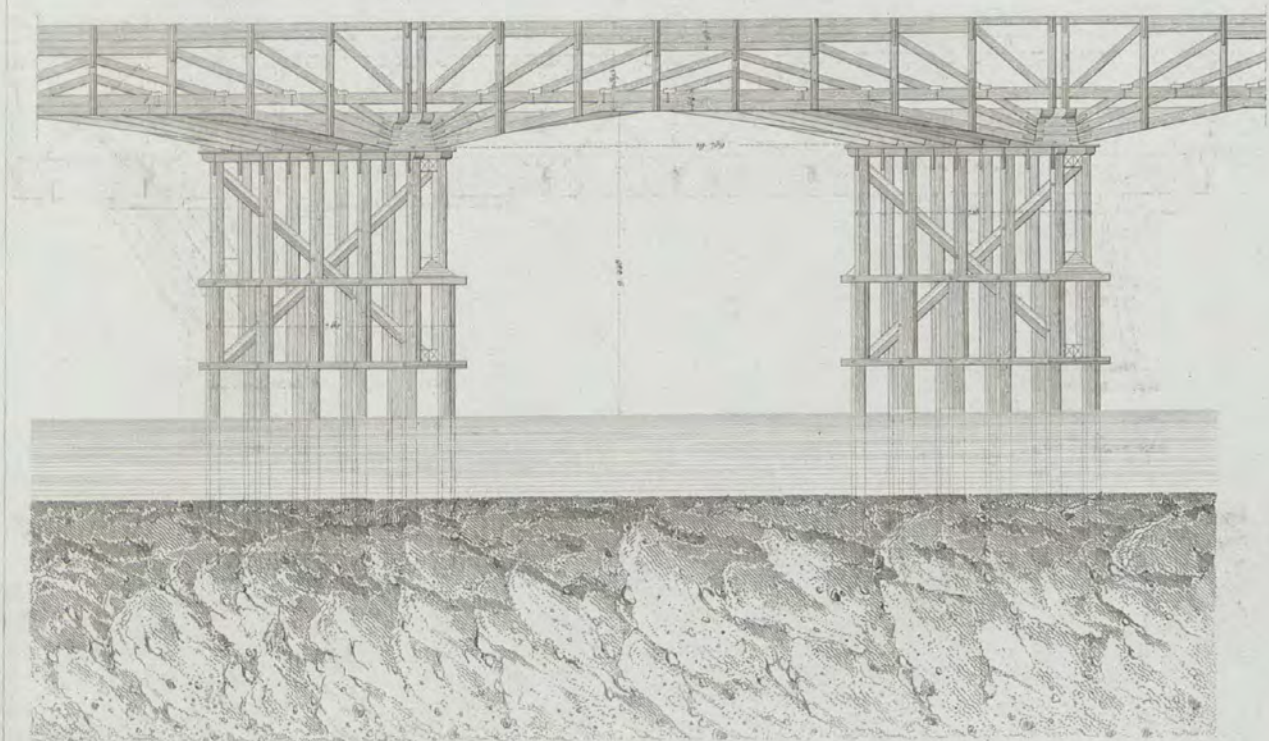

Fig. 1. Coupe transversale.

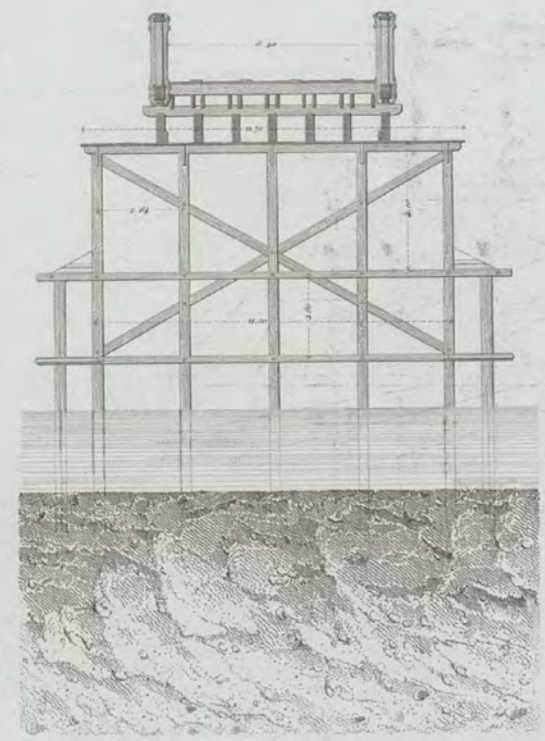

Fig. 2. Coupe transversale

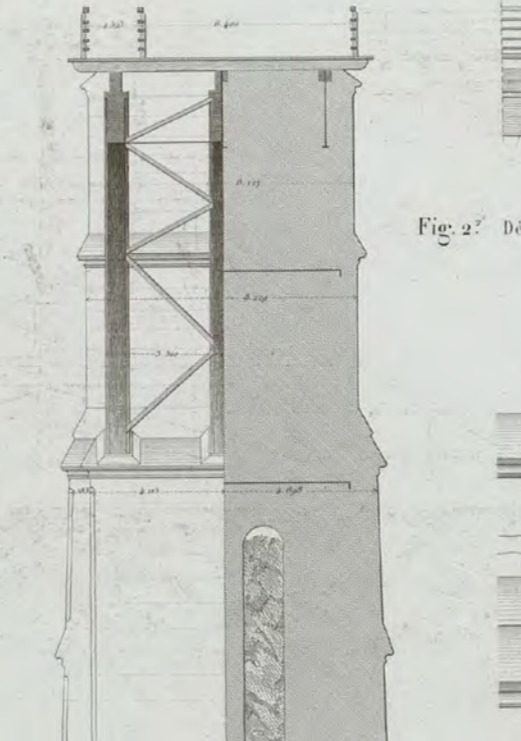

Fig. 2. Viaduc de Willington.

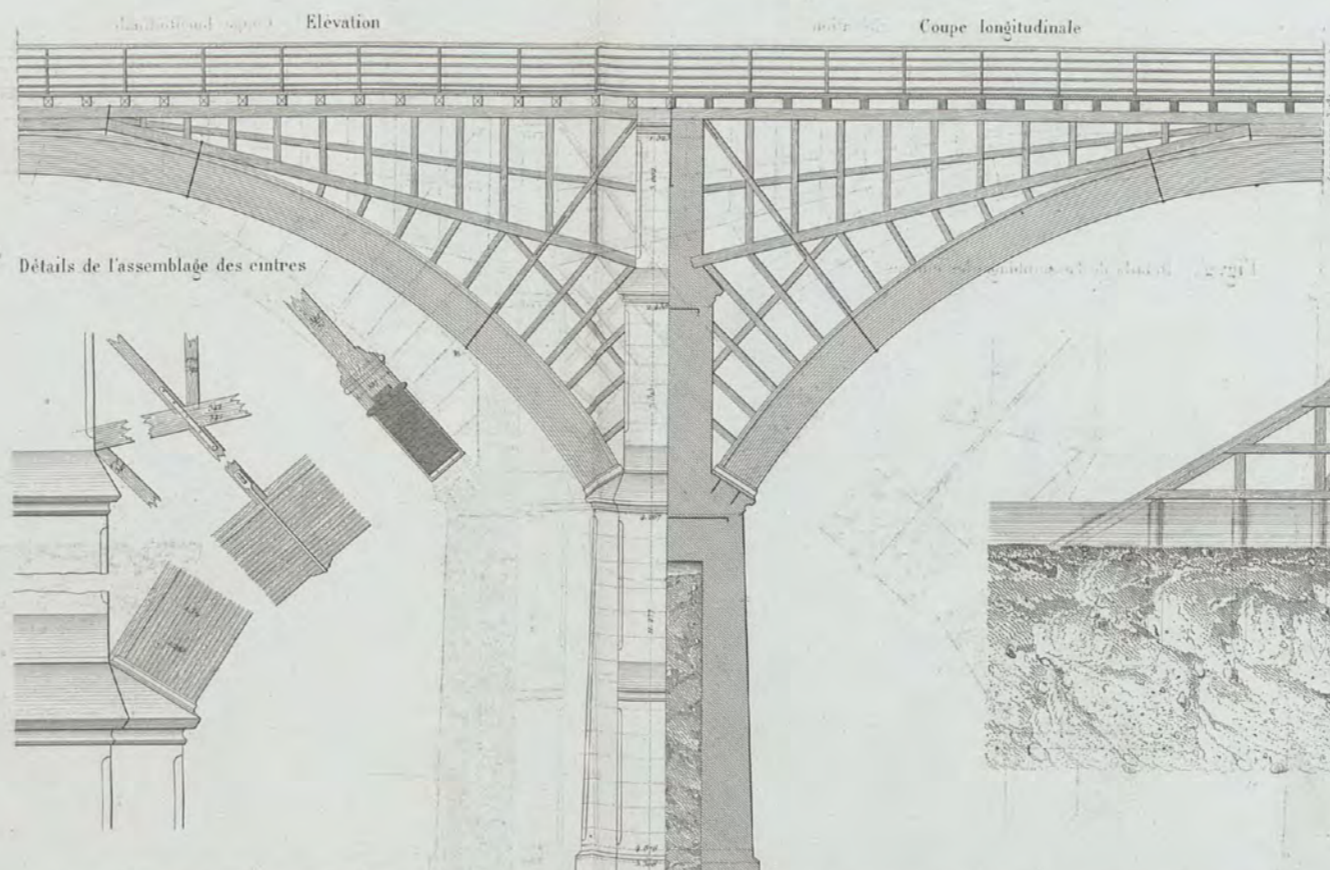

Fig. 2. Détails de l'assemblage des entres

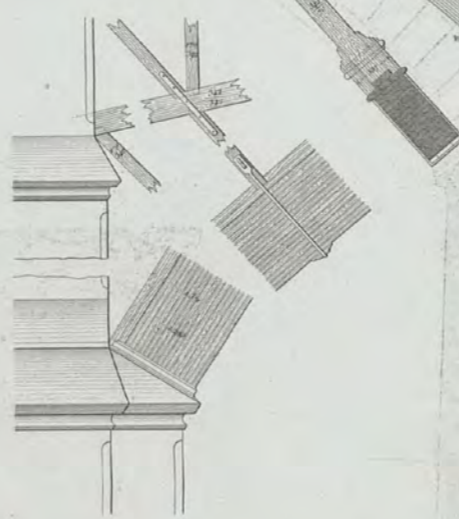

Fig. 3. Coupe transversale.

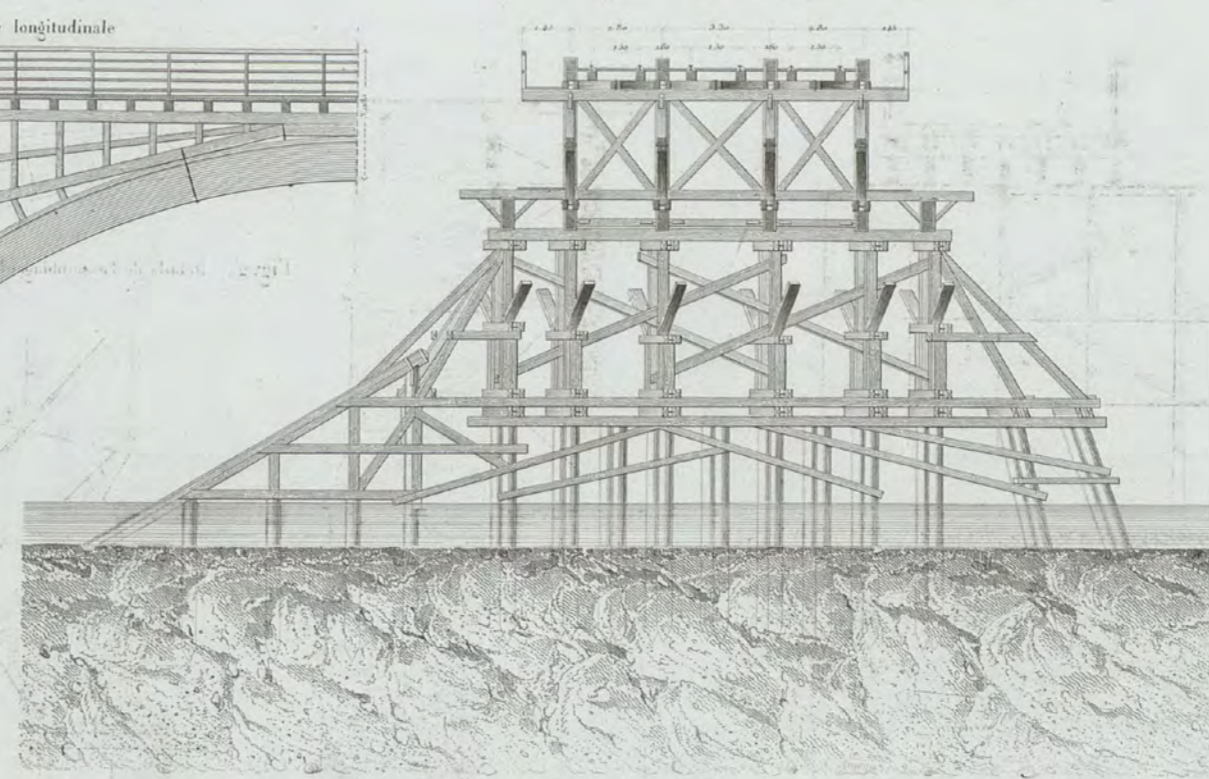

Fig. 5. Pont provisoire sur la Seine à Asnières.

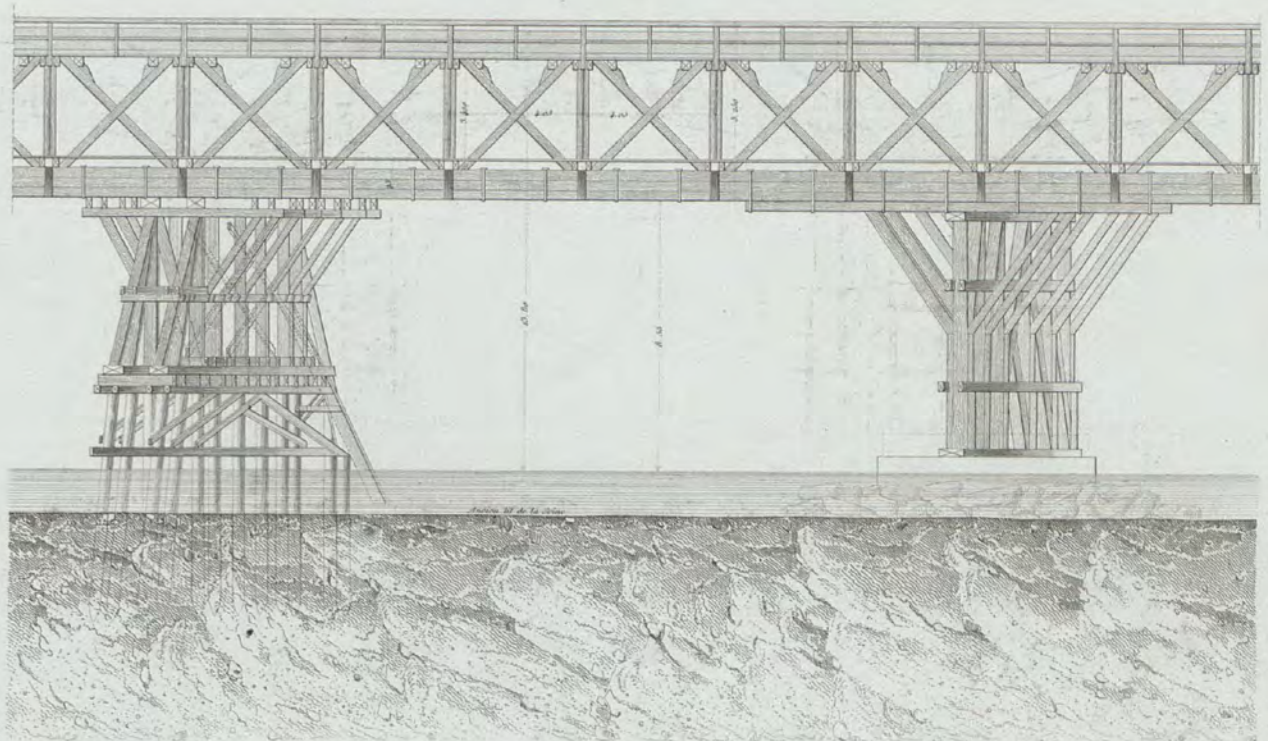

Fig. 4. Pont provisoire sur le Neckar



Fig. 4. Coupe transversale

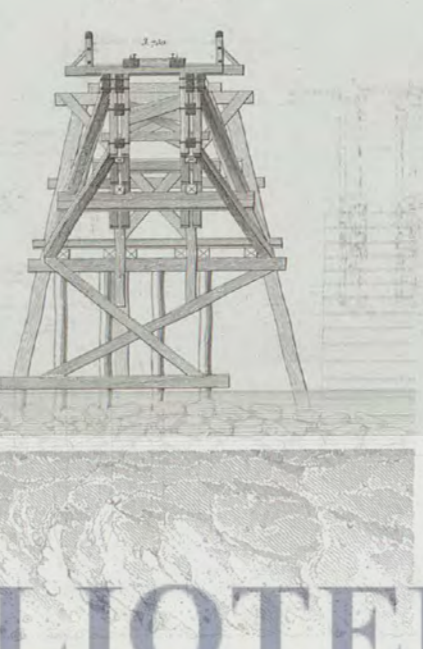

Fig. 2. Détails de la Voie.

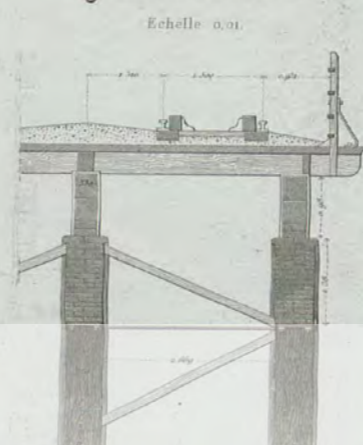

Fig. 2. Plan des contreventements

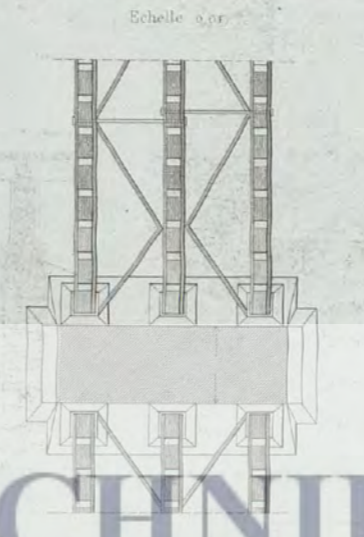

Fig. 5. Pont de Bandon

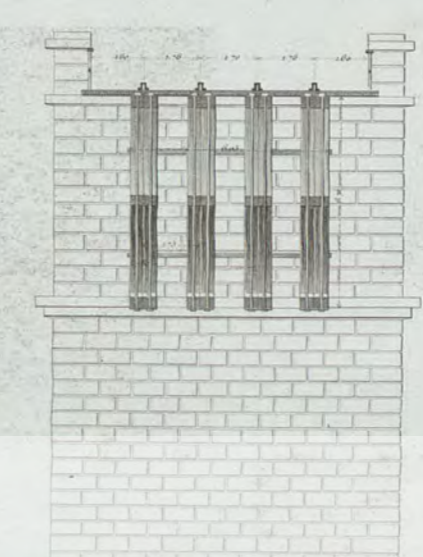

Fig. 6. Coupe transversale.

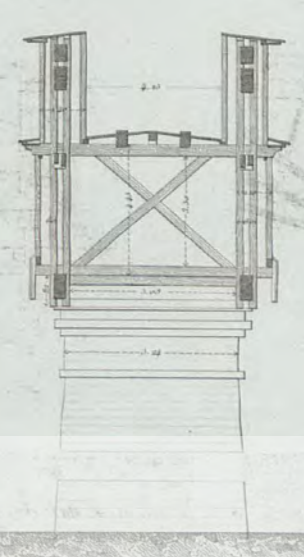
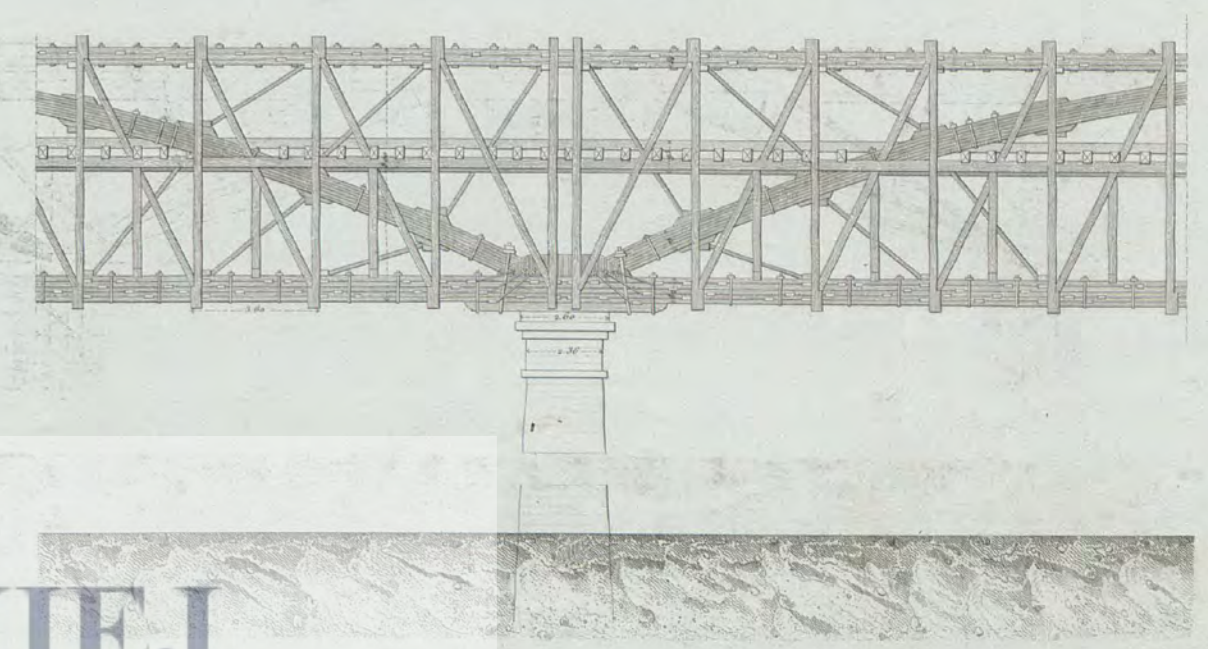

Fig. 6. Pont de Browns



BIBLIOTEKA CYFROWA POLITECHNIKI KRAKOWSKIEJ

Pont de Vina del Mar

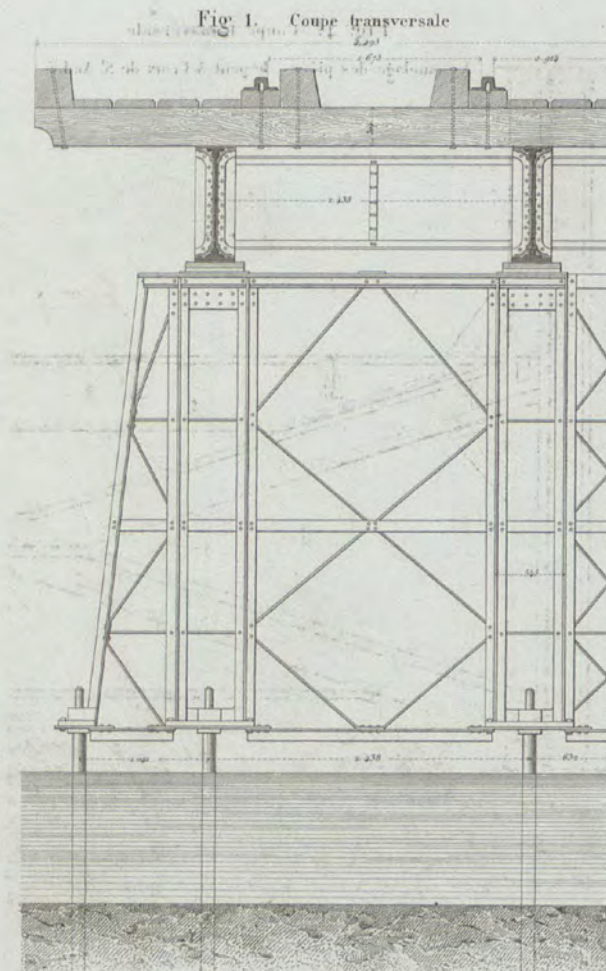
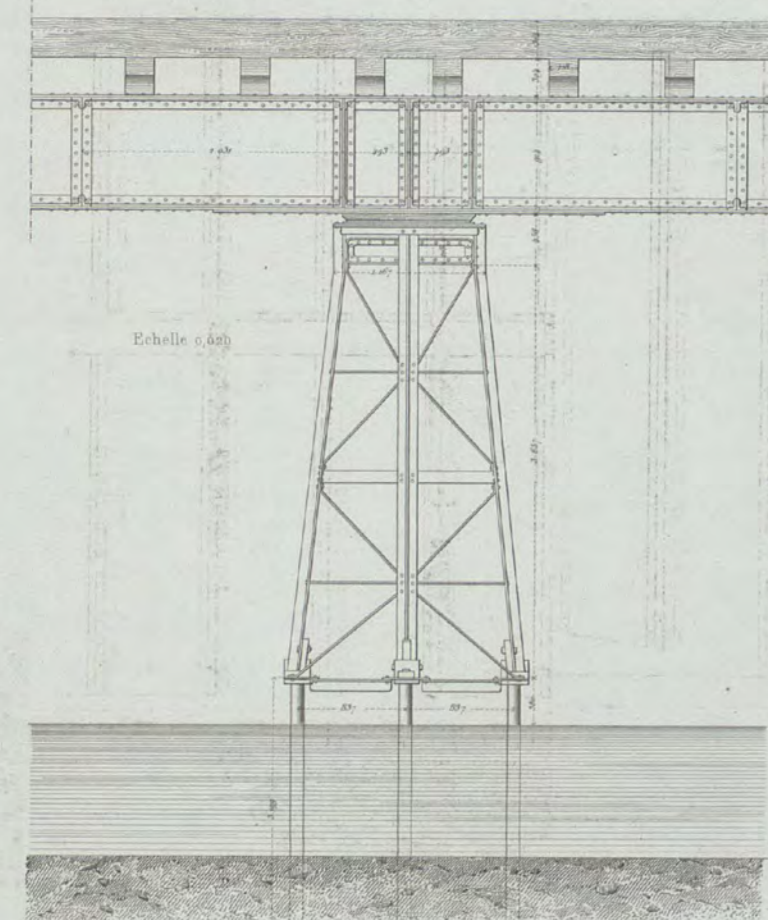

Fig. 1. Elevation longitudinale dans l'axe d'une travée.



Pont sur le Canal S<sup>t</sup> Denis

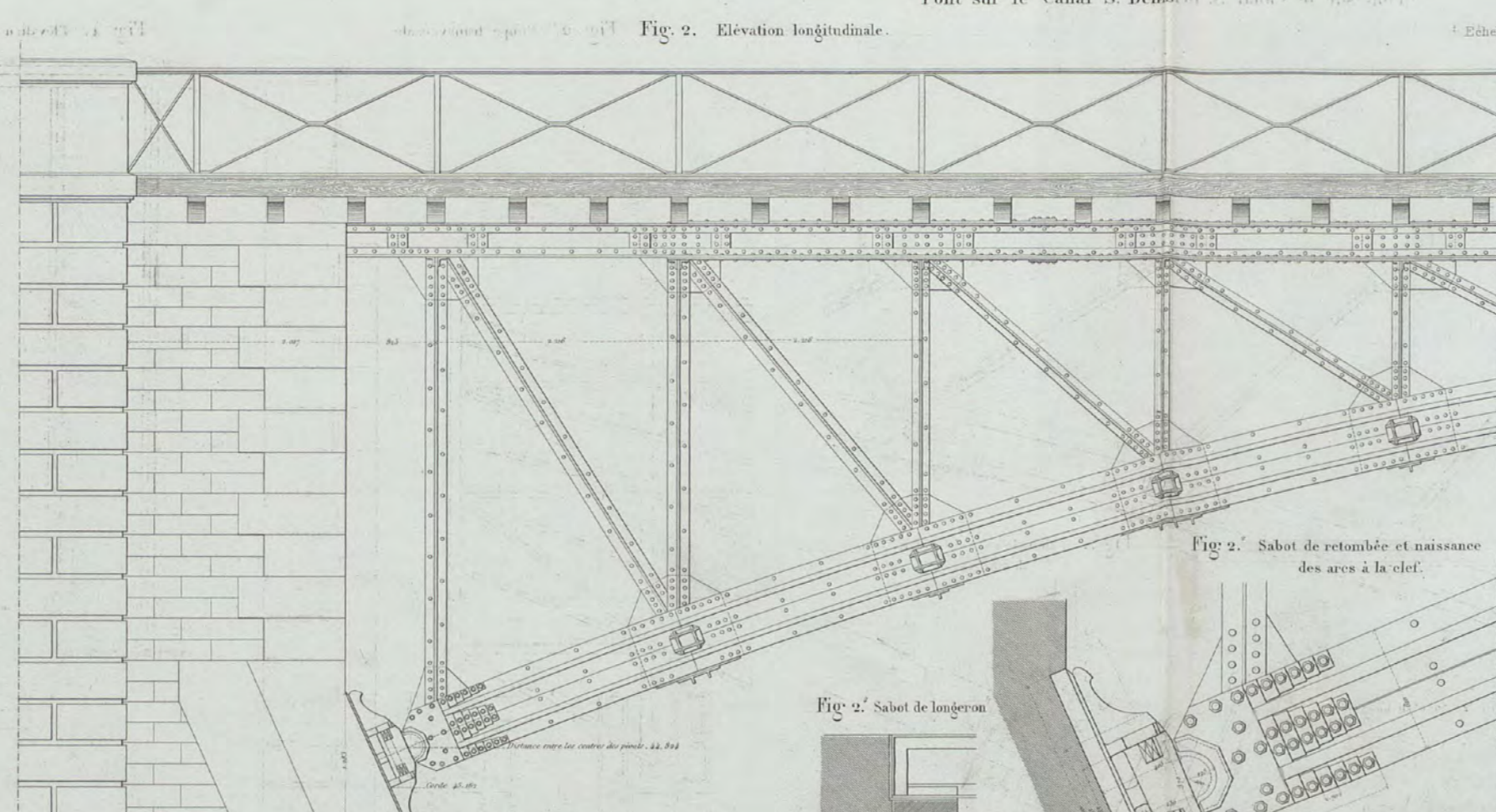
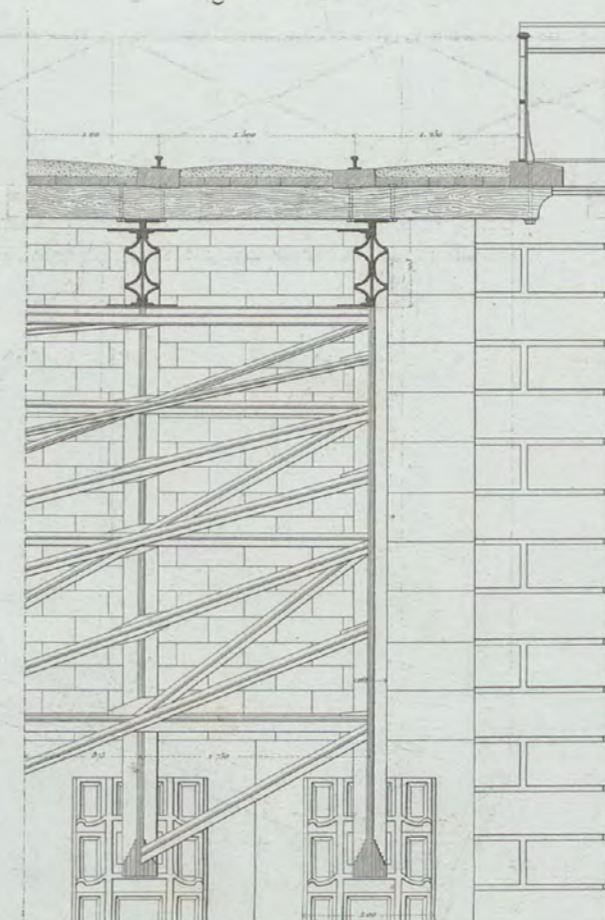

Fig. 2. Coupe transversale



Pont de Langon

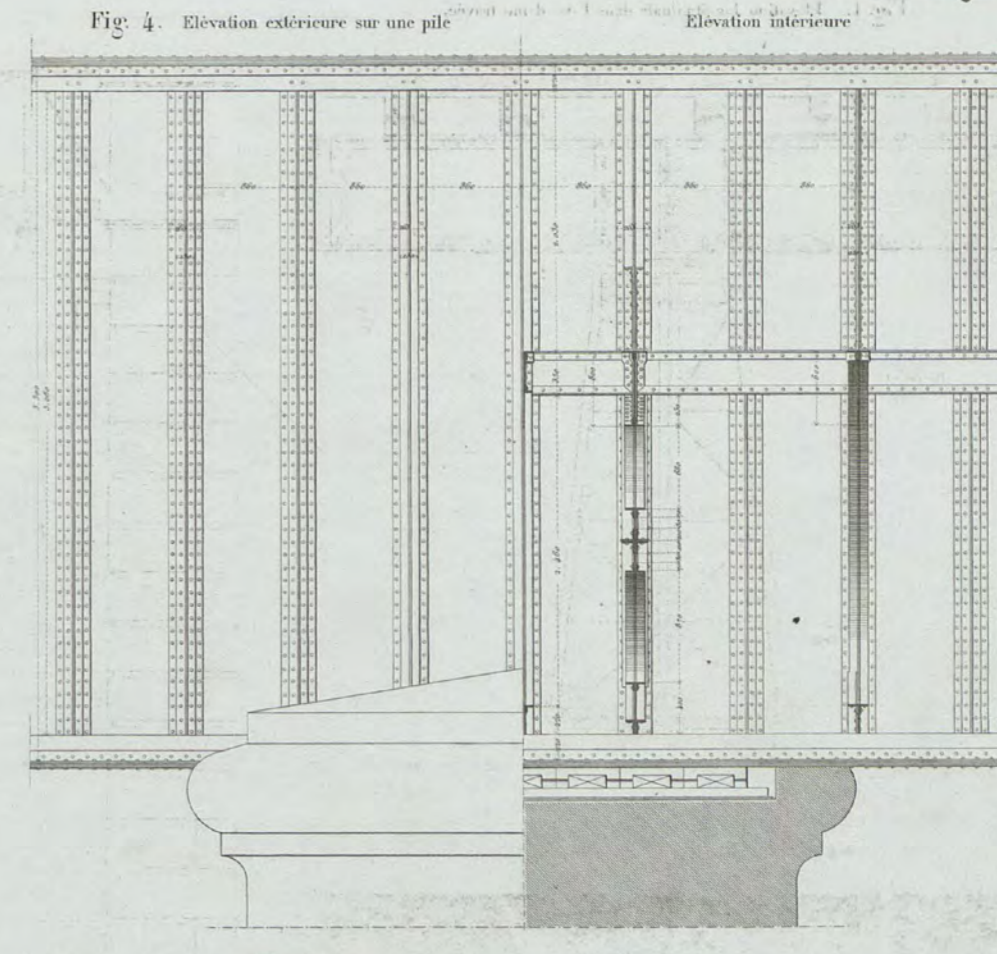
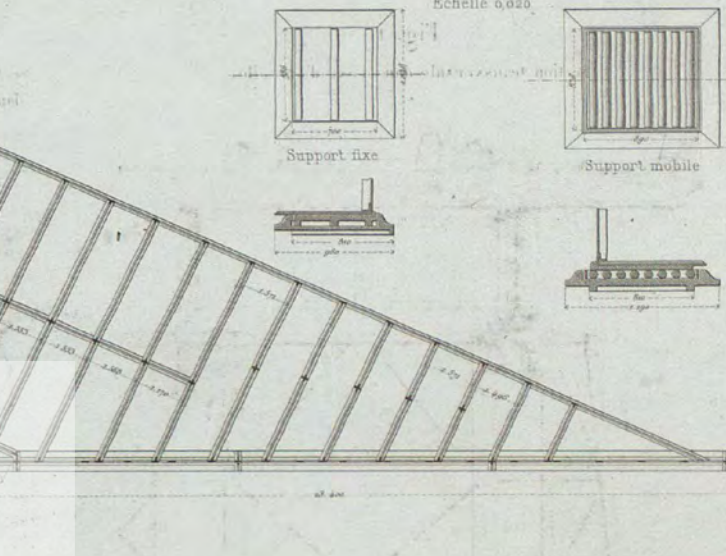
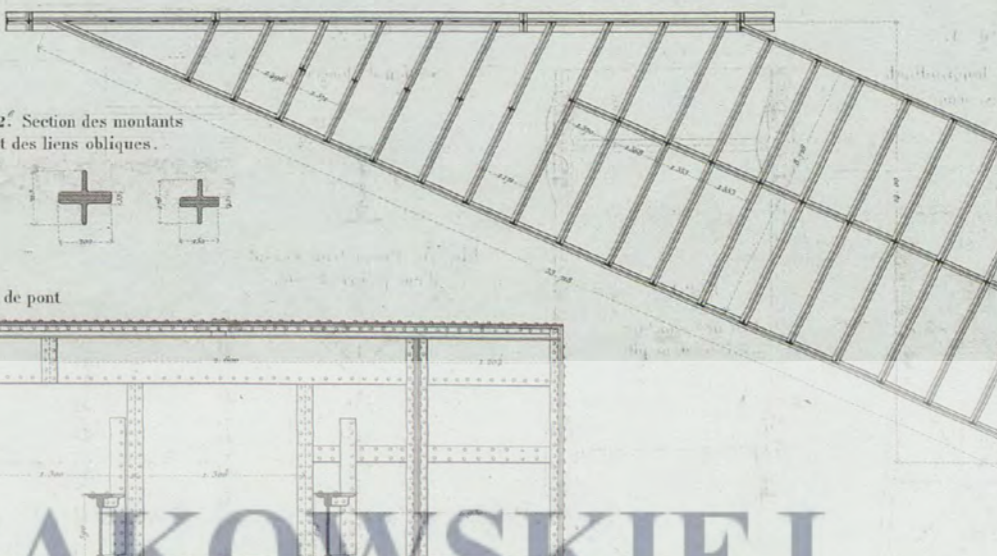
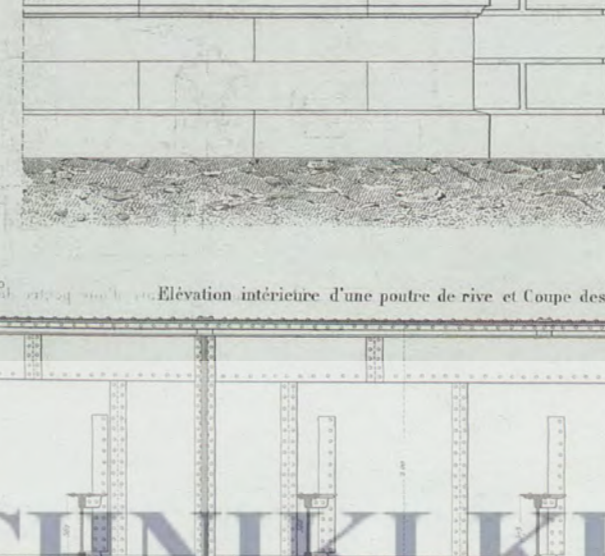
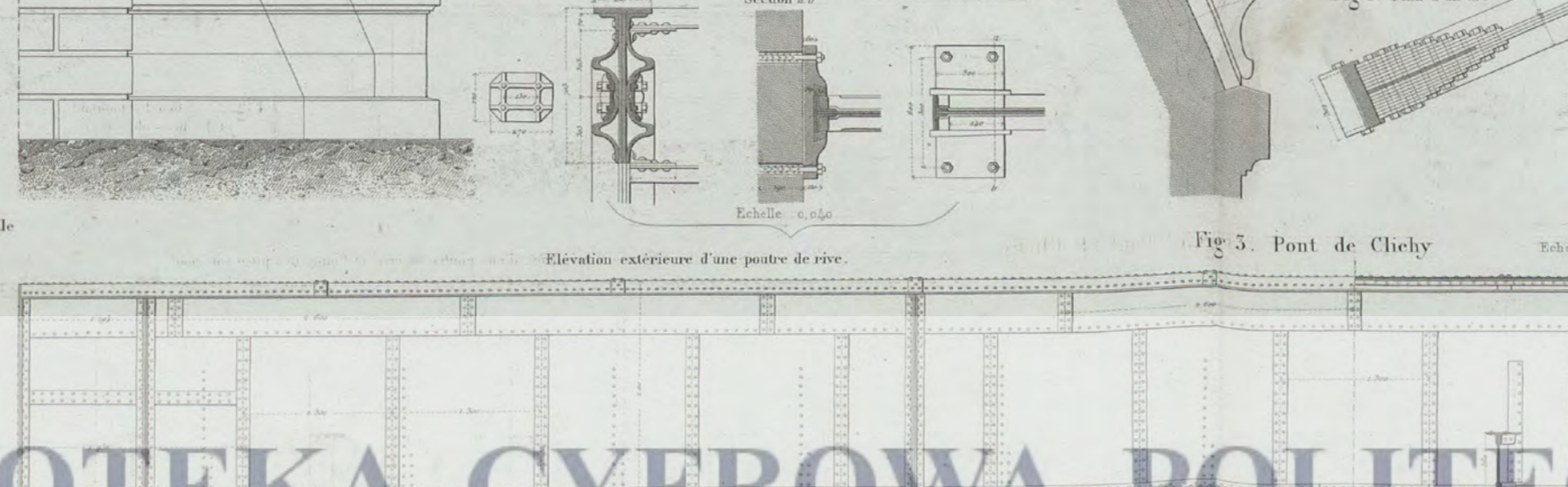
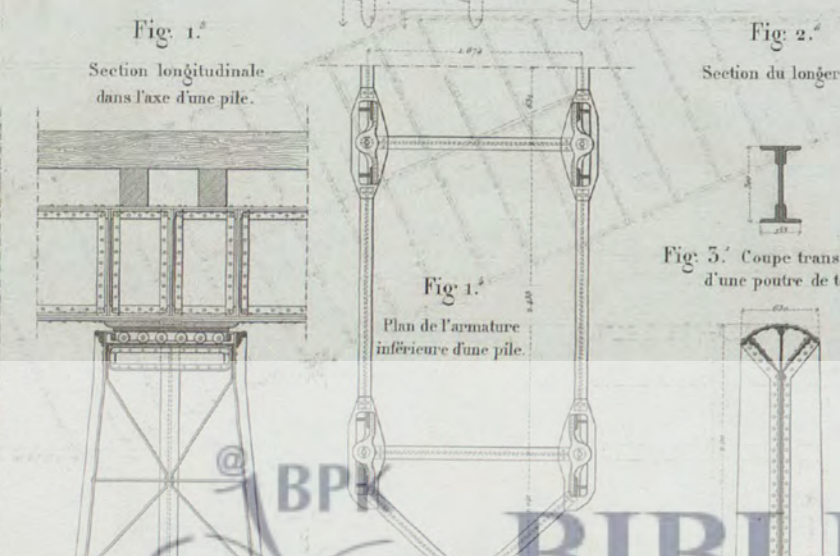
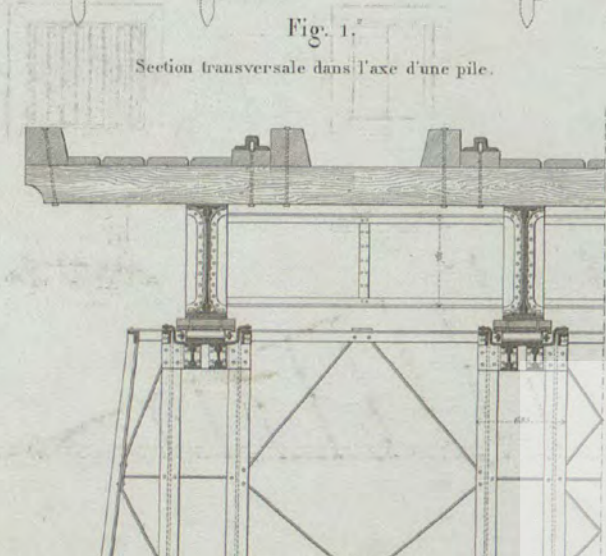
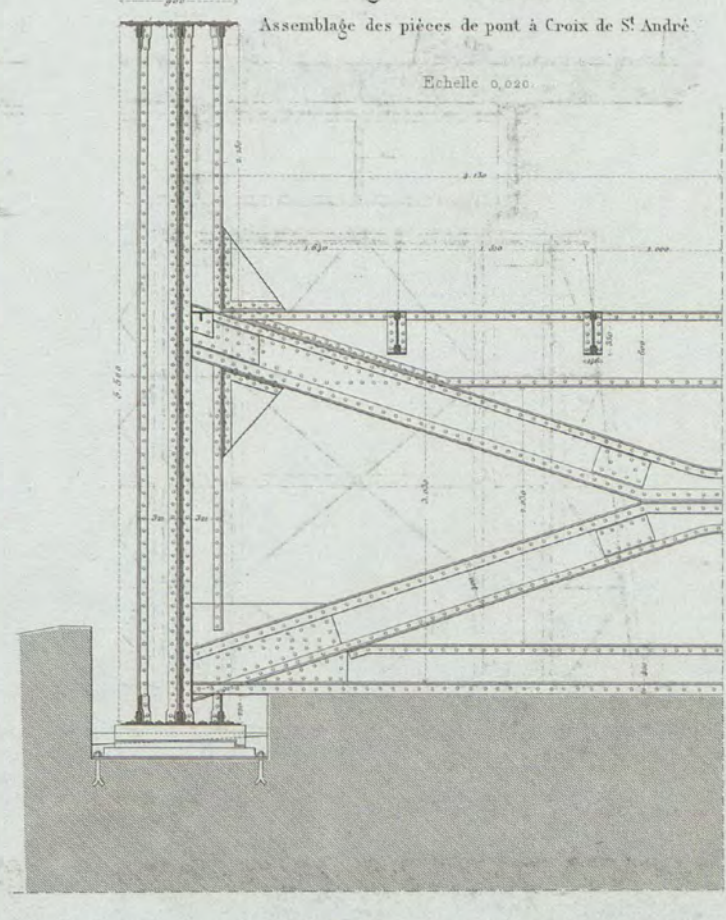

Fig. 4. Coupe transversale



BIBLIOTEKA CYFROWA POLITECHNIKI KRAKOWSKIEJ



Fig. 1. Pont de Windsor

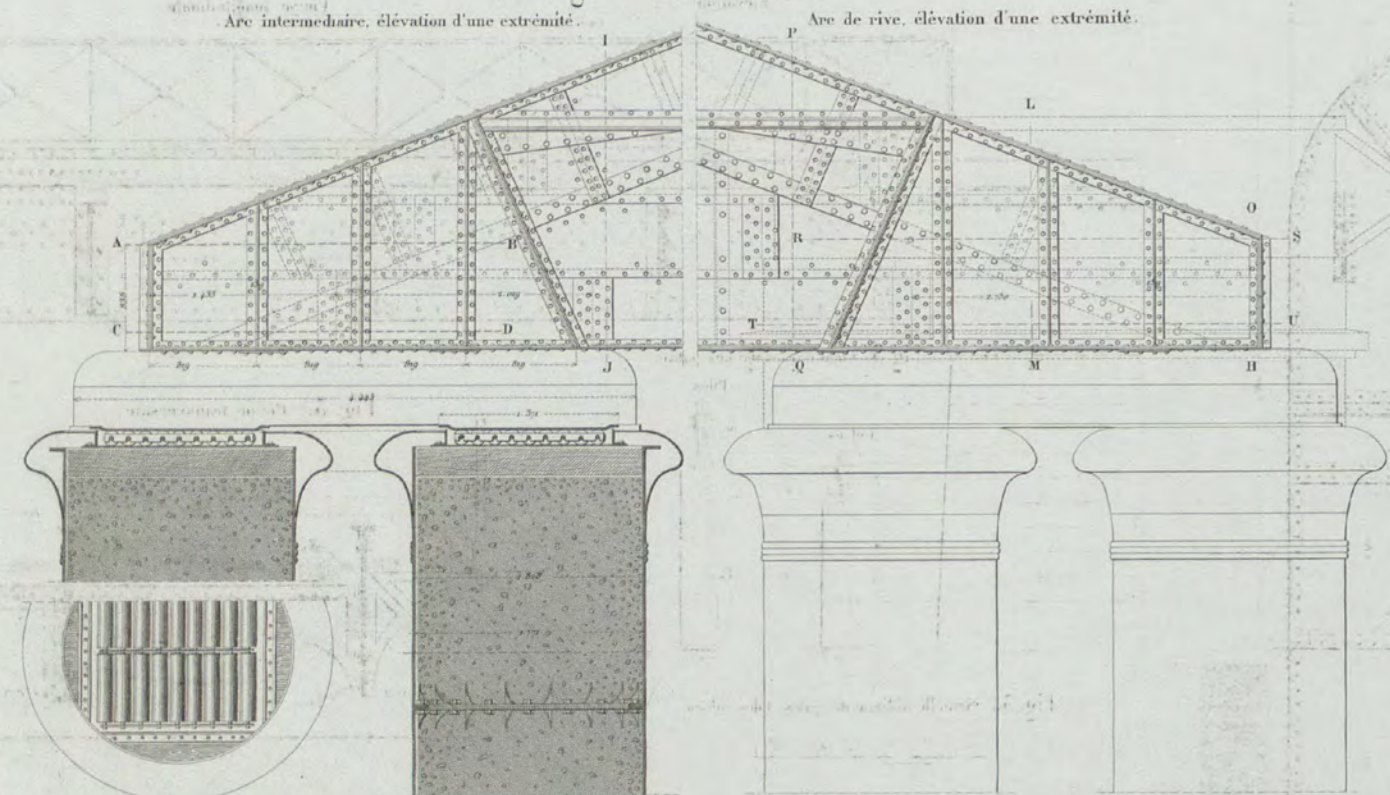

Fig. 2. Pont du Ciron

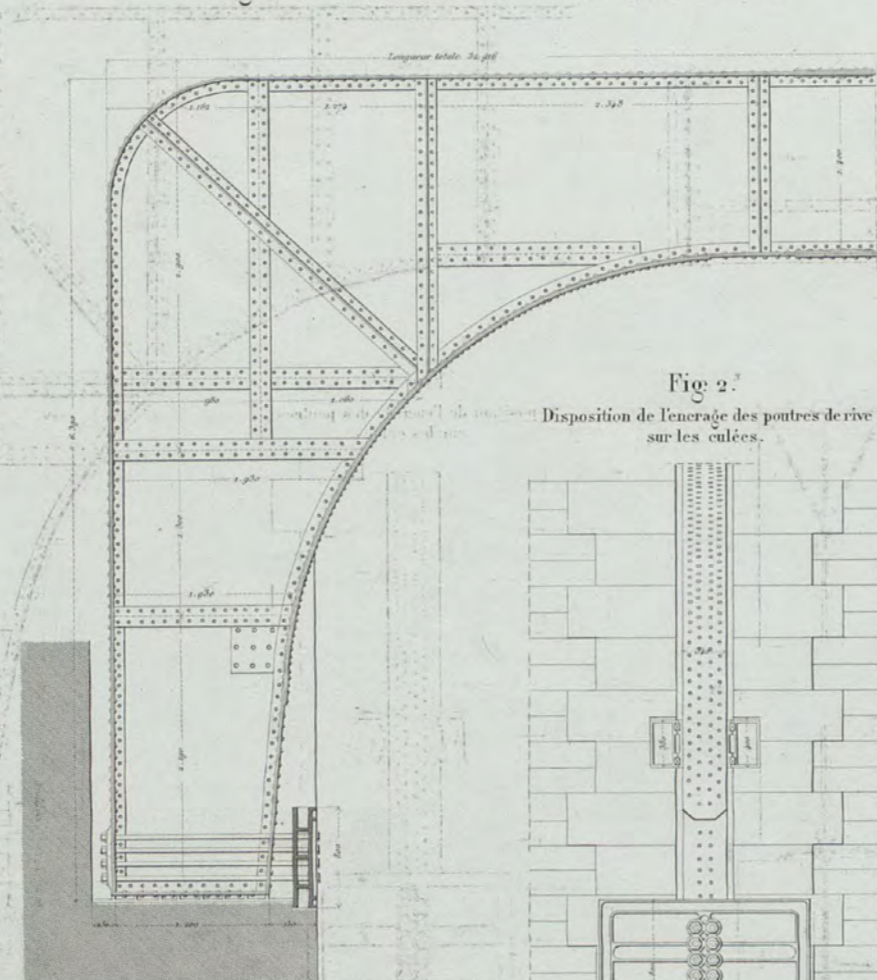

Fig. 2. Pont du Ciron  
Coupe transversale

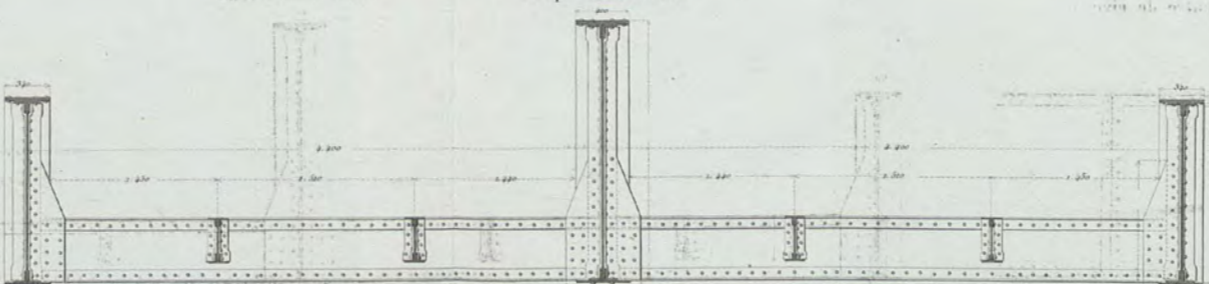

Fig. 2. Elévation intérieure d'une extrémité de poutre intermédiaire.

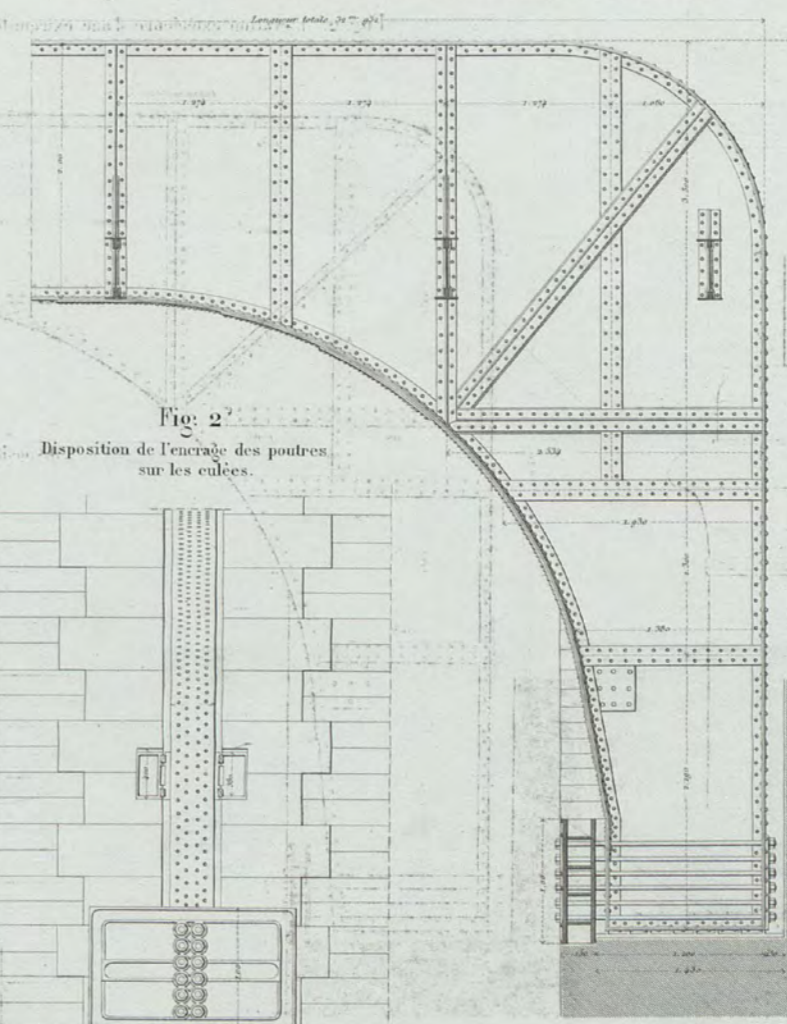

Fig. 3. Pont sur le Canal de l'Escaut

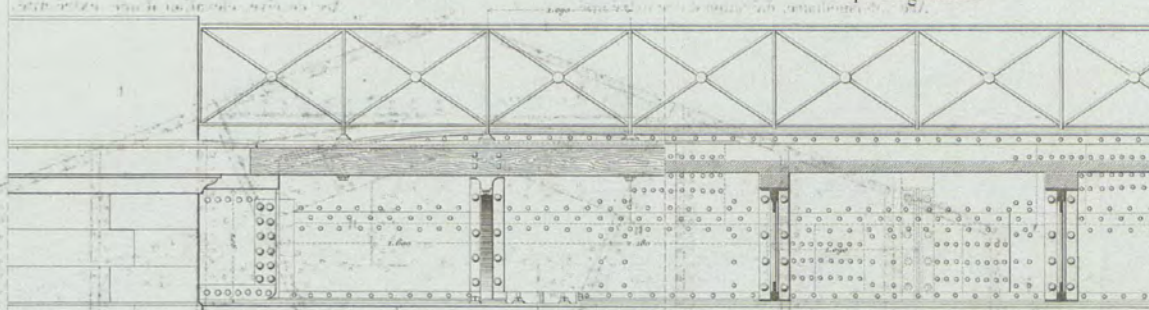

Fig. 3. Coils de serrage des patins

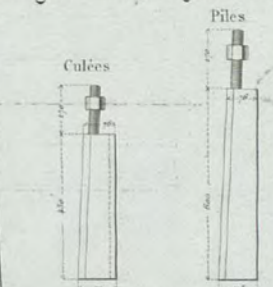

Fig. 3. Coupe transversale

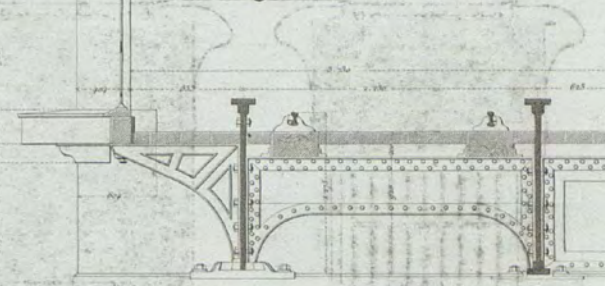

Fig. 2. Disposition de l'encrage des poutres de rive sur les culées.

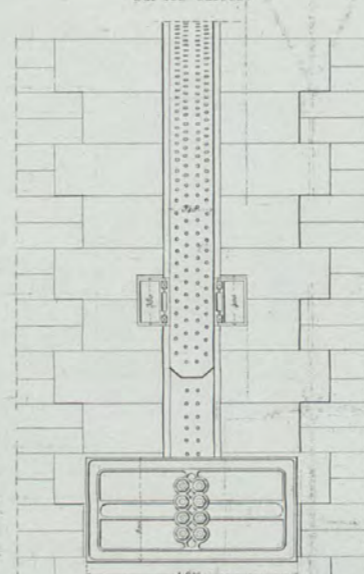

Fig. 1. Coupe transversale

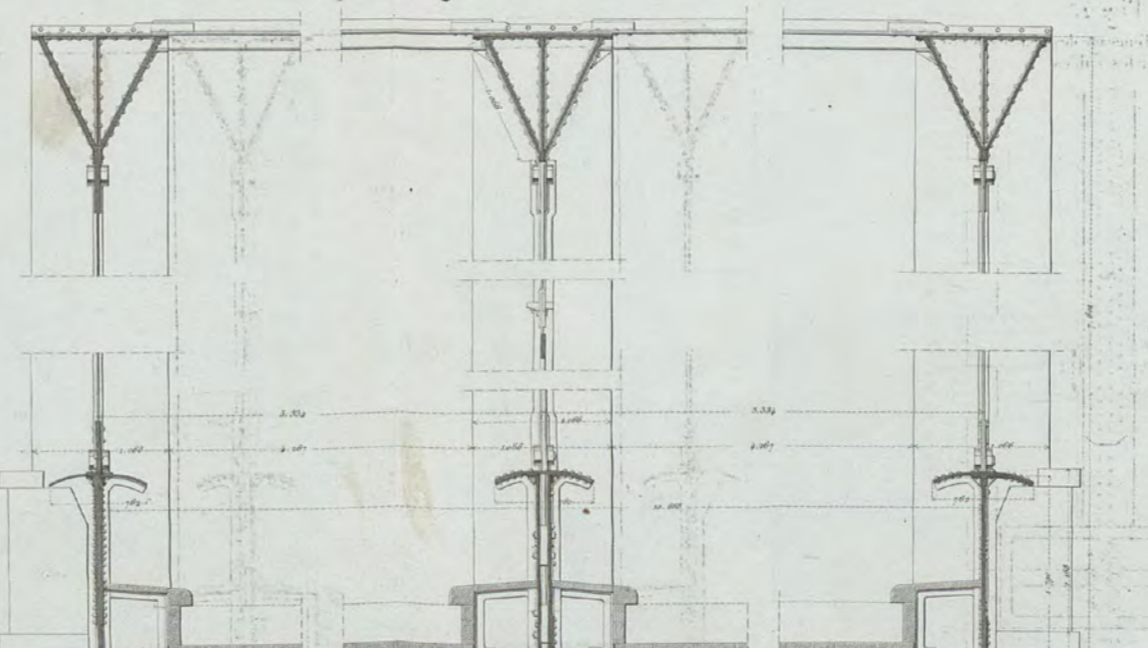

Fig. 2. Disposition de l'encrage des poutres sur les culées.

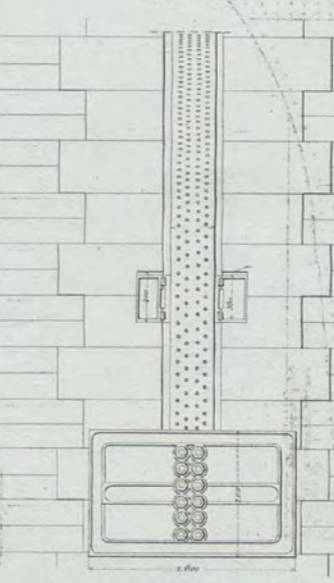

Fig. 3. Semelle oblique des piles et des culées

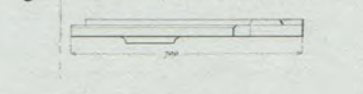

Fig. 1. Arc de Rive. Elévation extérieure

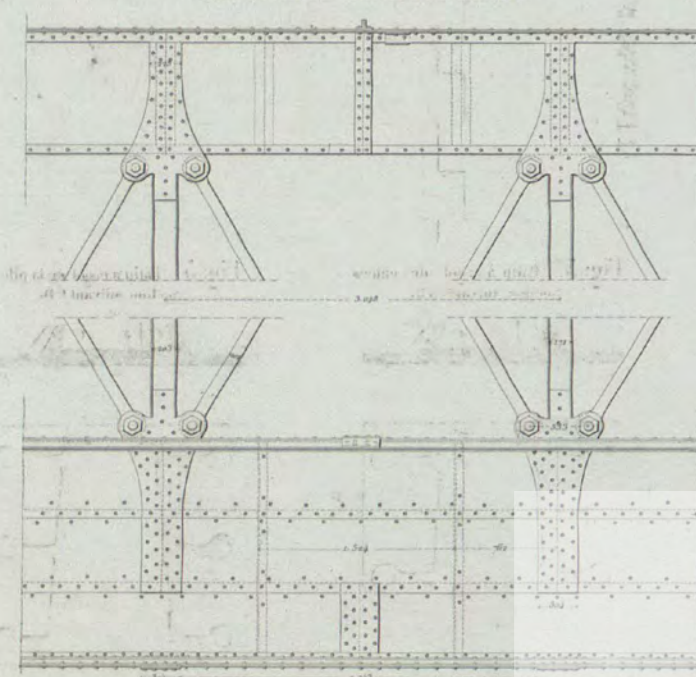

Fig. 1. Arc intermédiaire. Elévation intérieure

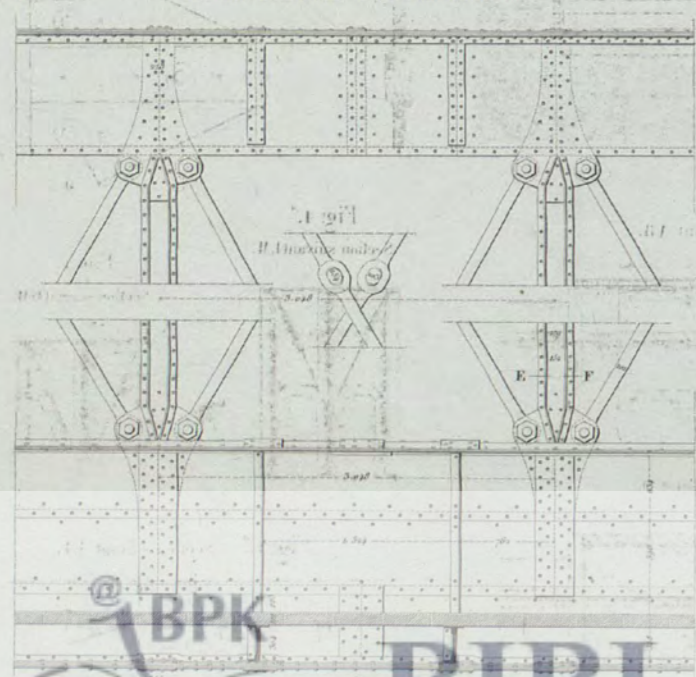

Fig. 1. Section suivant RS.

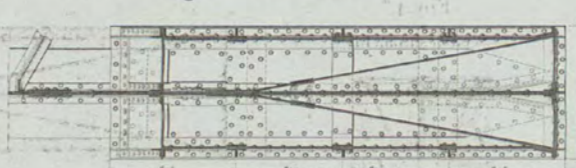

Fig. 1. Section suivant PQ.

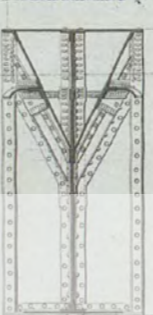

Fig. 1. Section suivant TU.

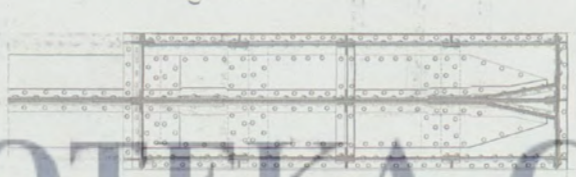

Fig. 1. Section suivant AB.

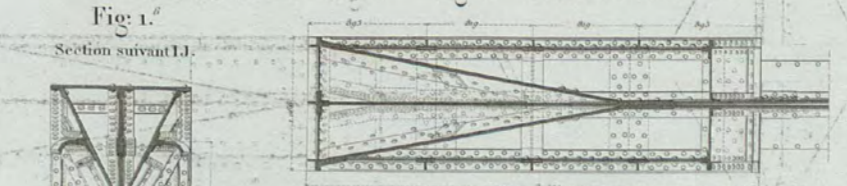

Fig. 1. Section suivant IJ.



Fig. 1. Section suivant CD.

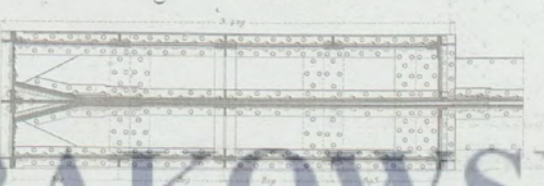

Fig. 1. Section suivant LM.

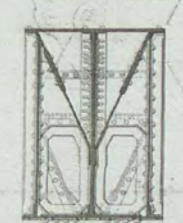

Fig. 1. Section suivant OI.



Fig. 1. Section suivant EF.



Fig. 3. Patin à ergot des culées Section suivant AB.

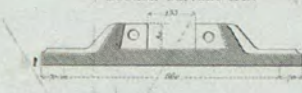
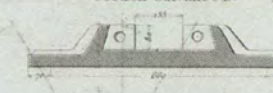
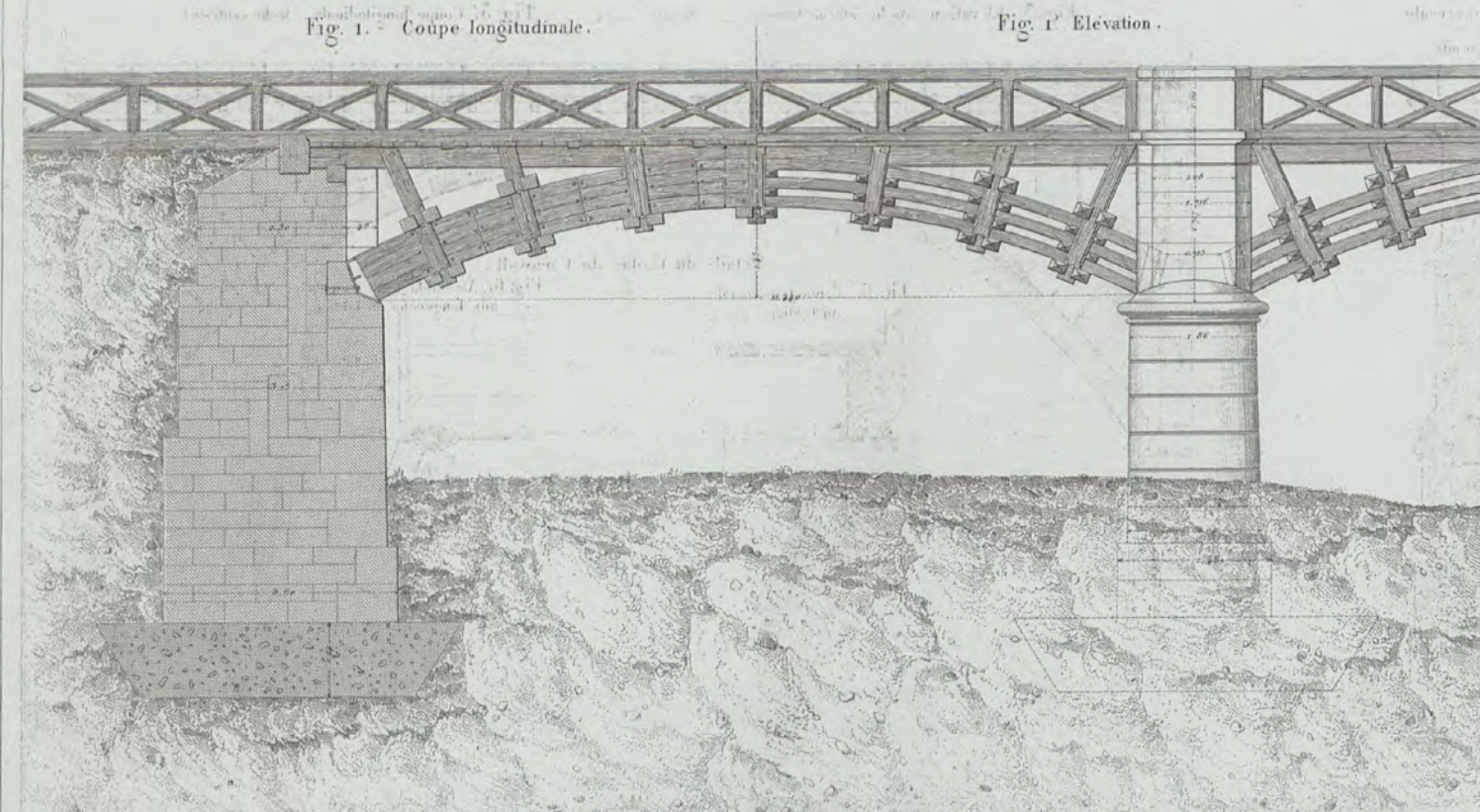

Fig. 3. Patin à ergot de la pile Section suivant CD.



BIBLIOTEKA CYFROWA POLITECHNIKI KRAKOWSKIEJ

Pont sur la Murg. Echelle 001



Pont sur la Msta. Echelle 0005. Fig. 2. Coupe transversale. Fig. 2. Elevation.

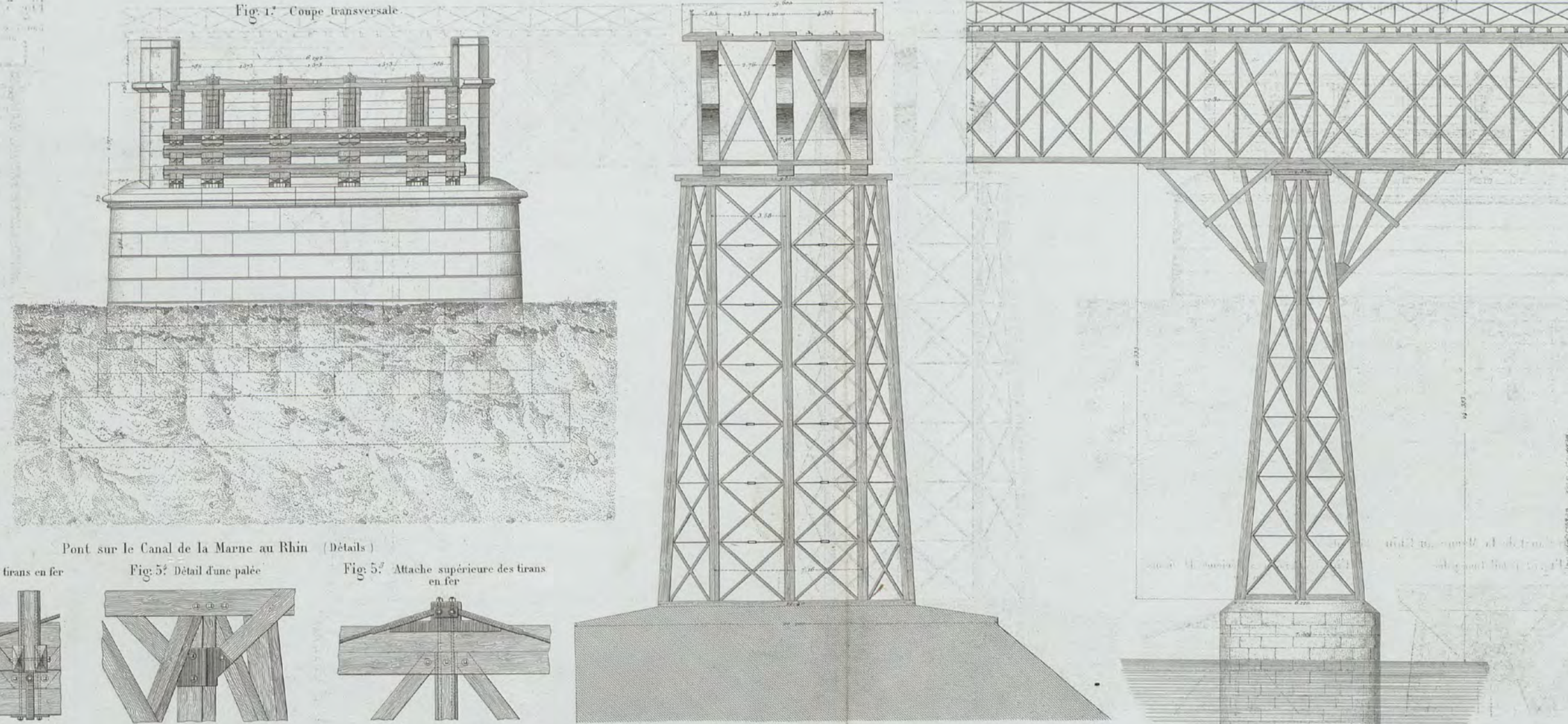

Viaduc de Wellington Dean. Echelle 0004

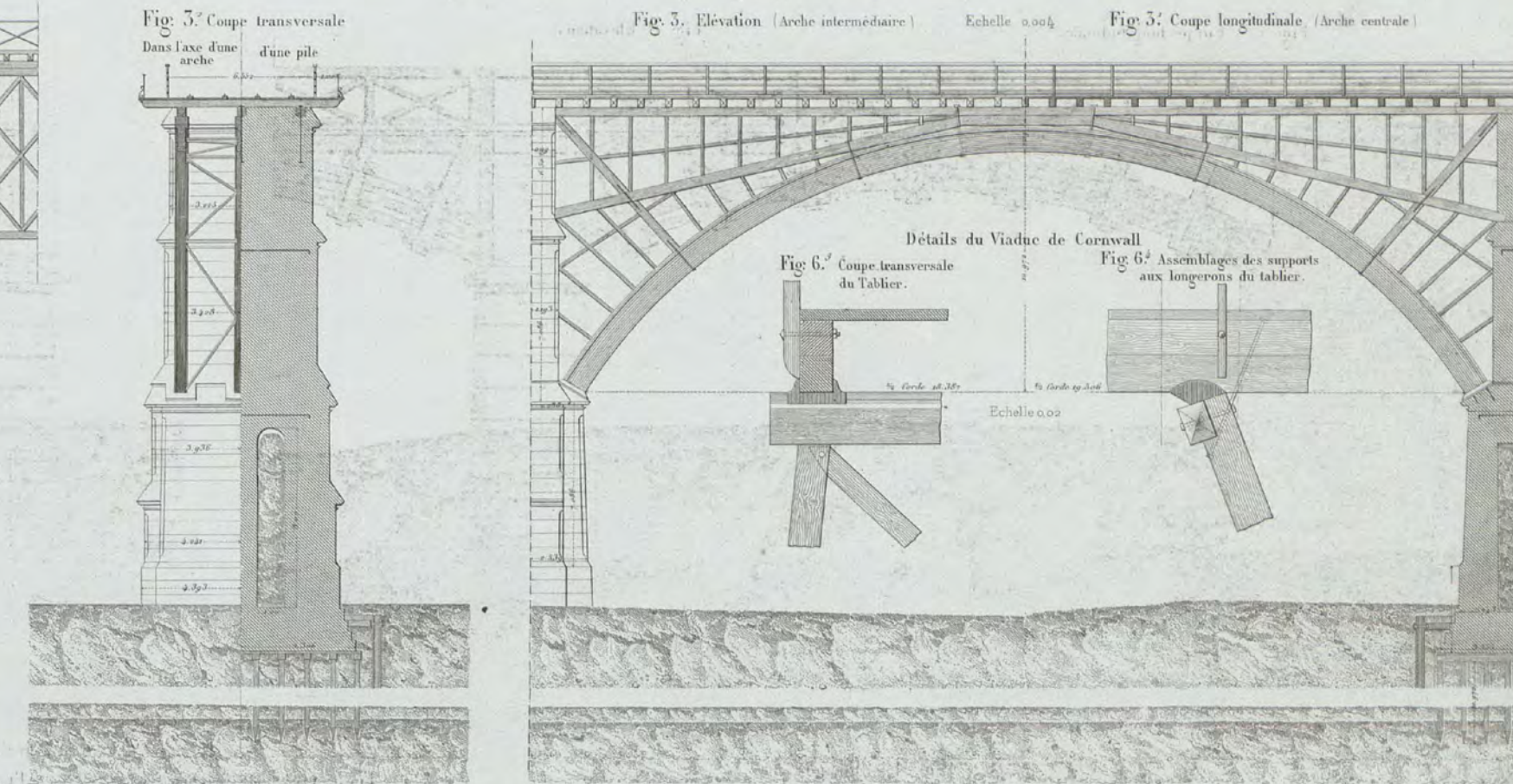

Pont de Chikapoc. Echelle 0005

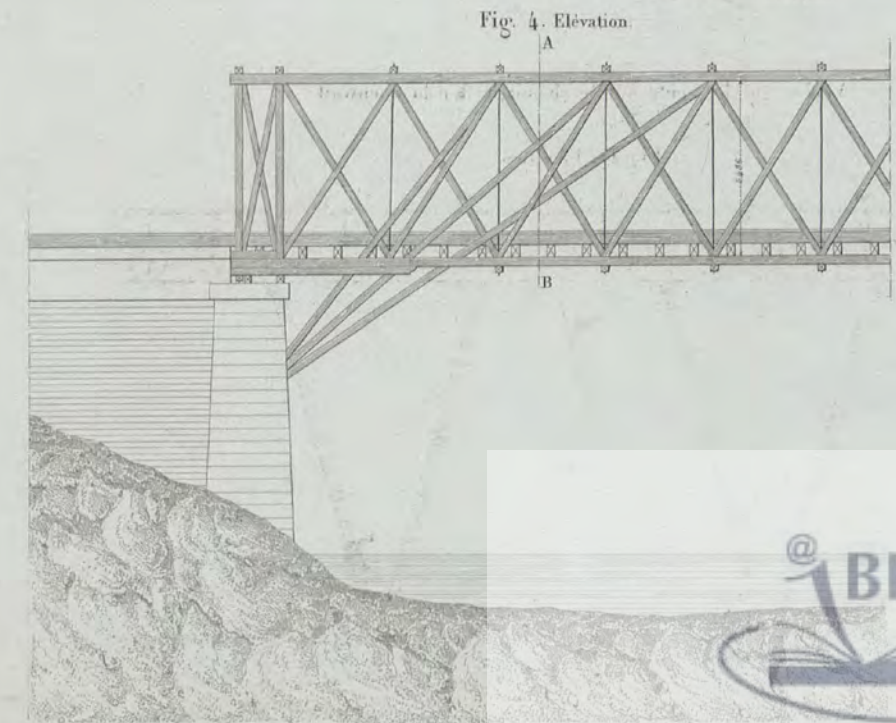

Pont sur le Canal de la Marne au Rhin (Détails). Echelle 002

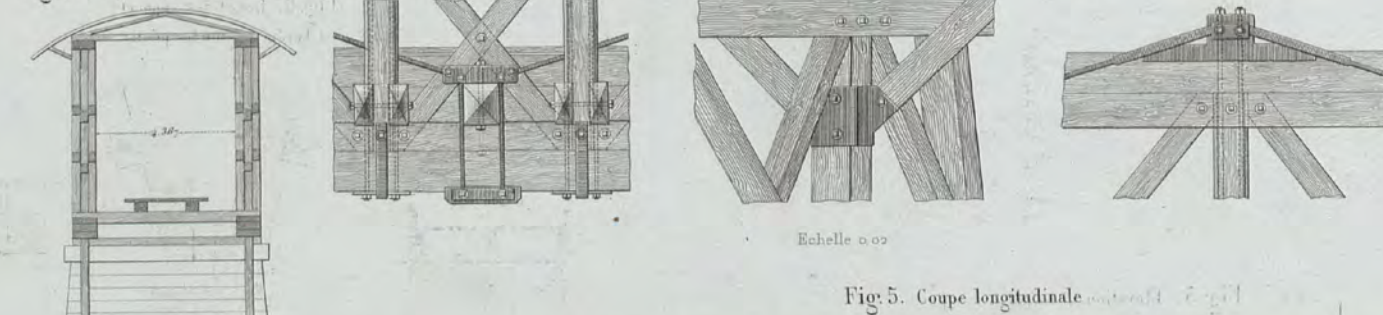

Pont Américain sur le Canal de la Marne au Rhin. Echelle 0005



Viaduc en charpente sur le chemin de fer du Cornwall. Echelle 0005

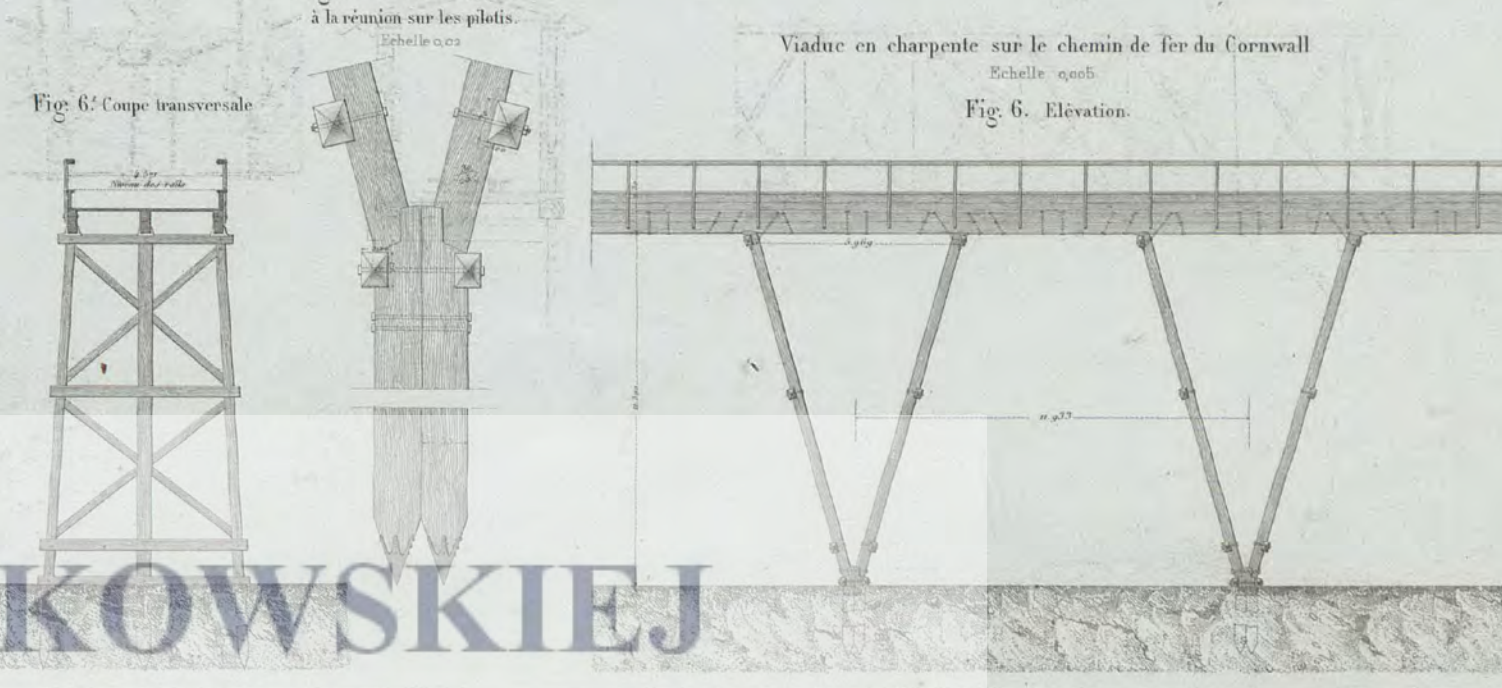

BIBLIOTEKA CYFROWA POLITECHNIKI KRAKOWSKIEJ



Fig. 1  
Culée. Côté de Beaucaire. Elevation.

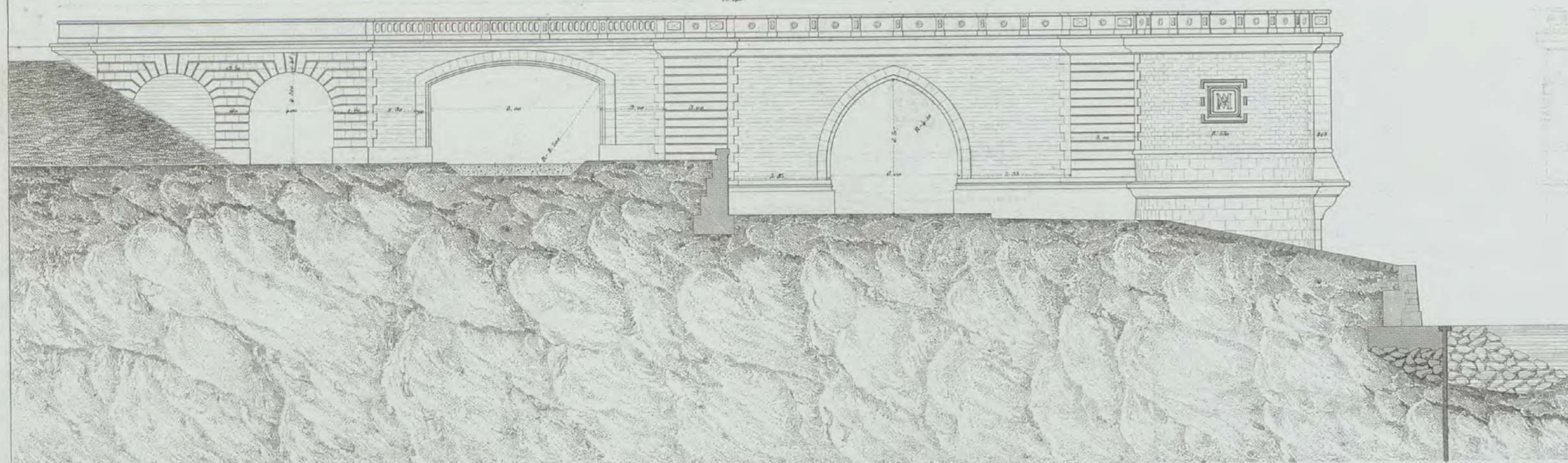

Fig. 2  
Pile. Elevation.

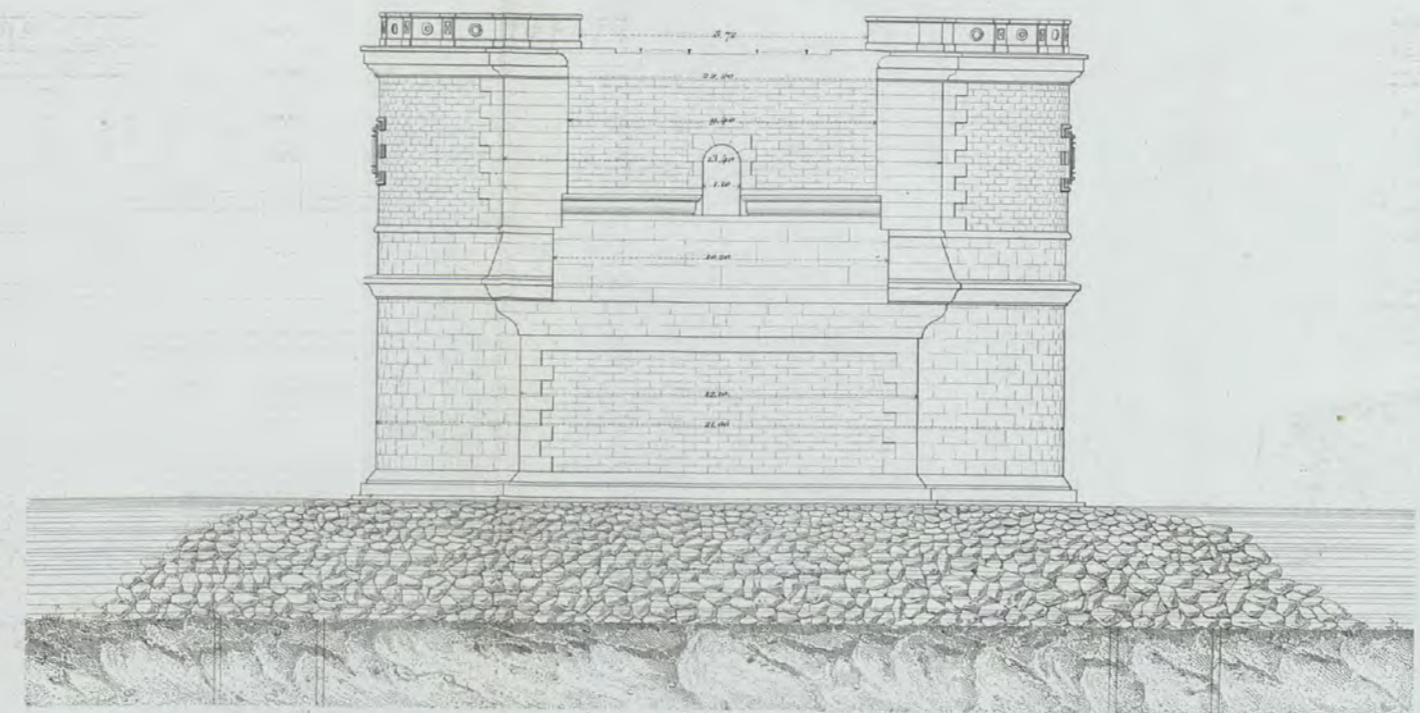

Fig. 5  
Culée. Côté de Tarascon. Elevation.

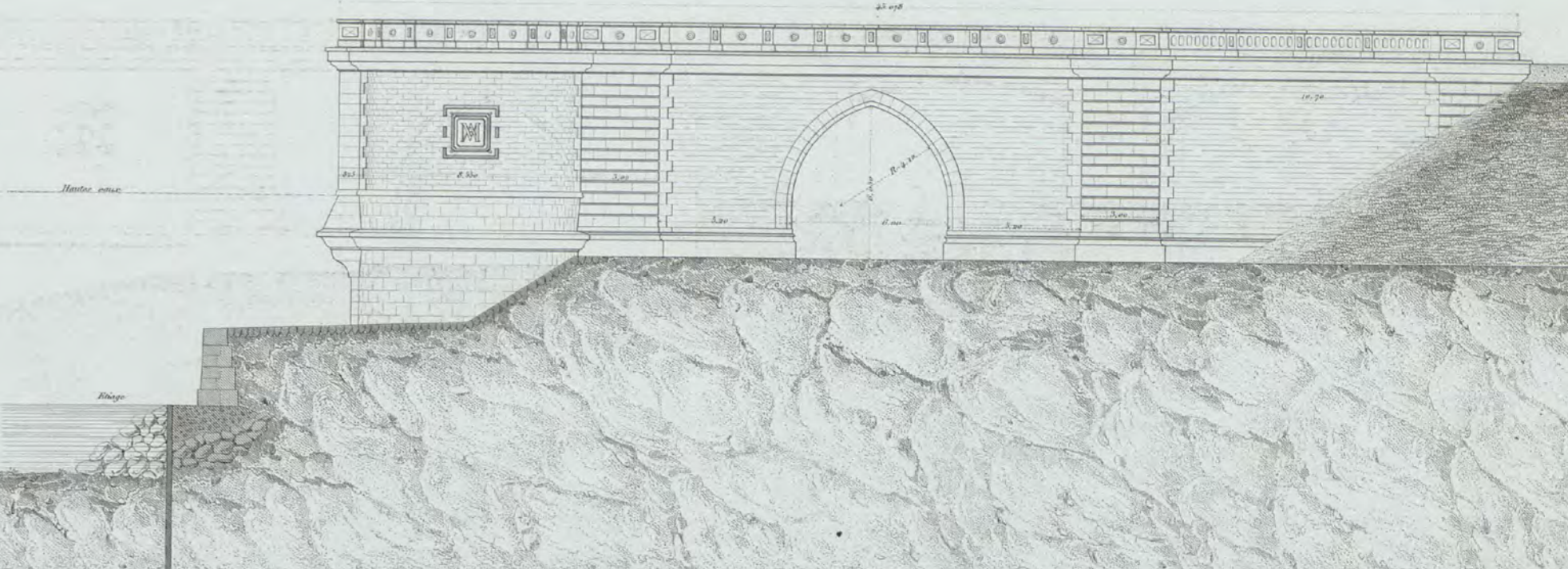

Fig. 1<sup>r</sup>  
Culée. Côté de Beaucaire. Coupe.

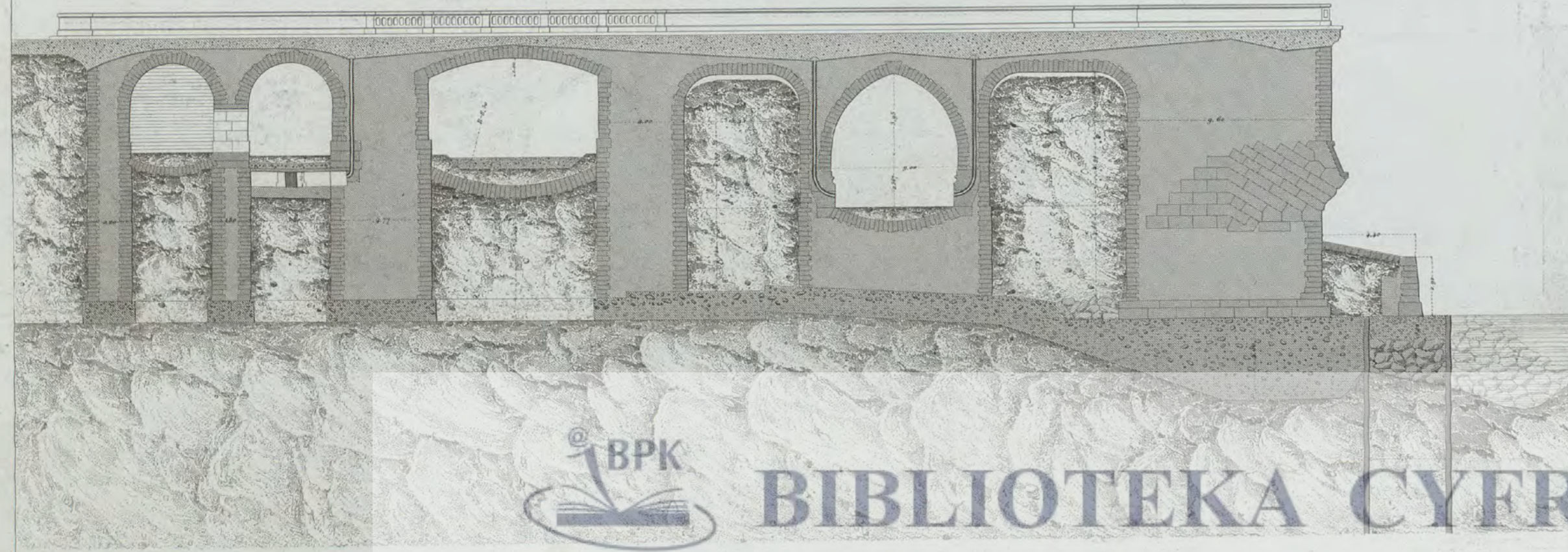

Fig. 2<sup>r</sup>  
Pile. Coupe longitudinale.

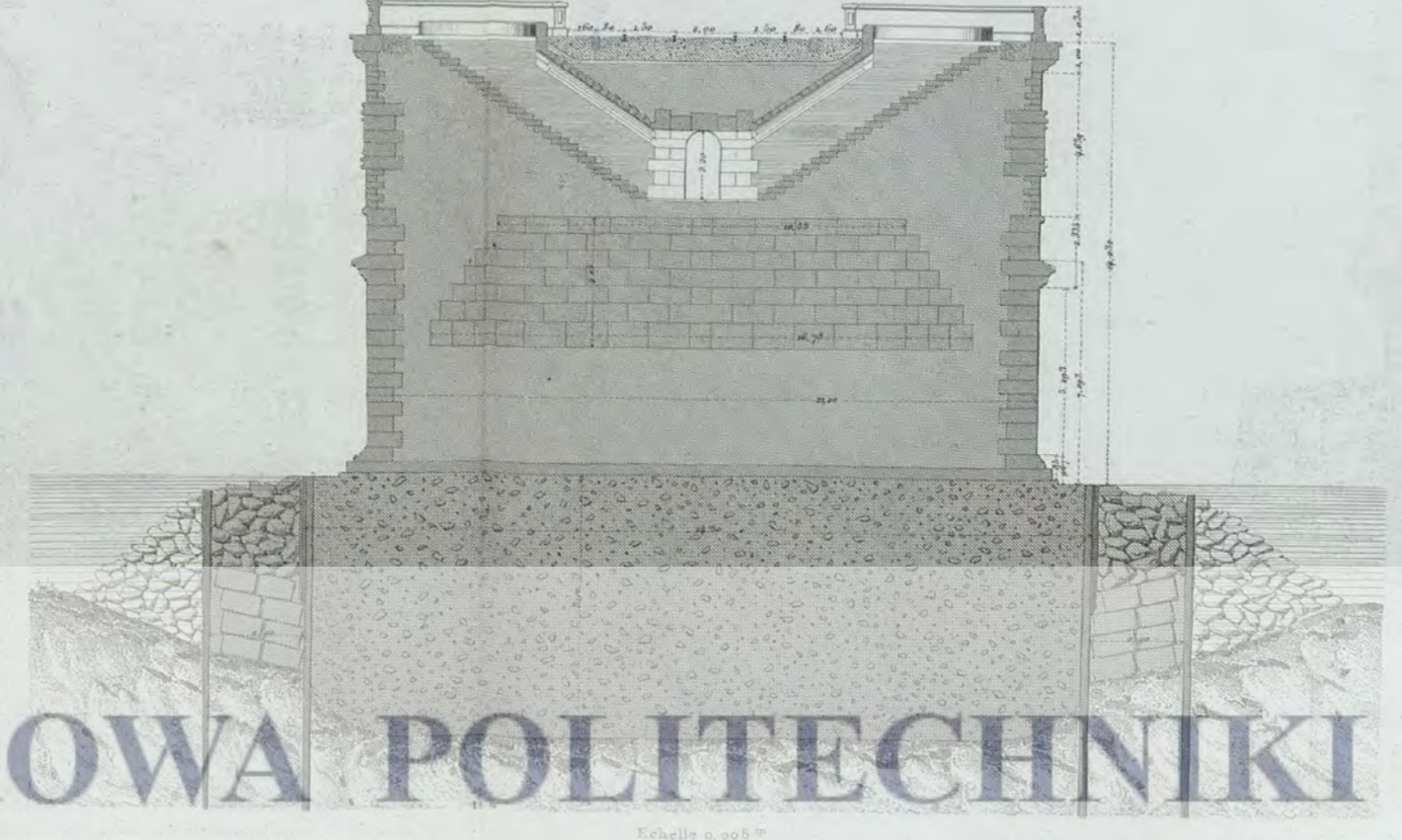
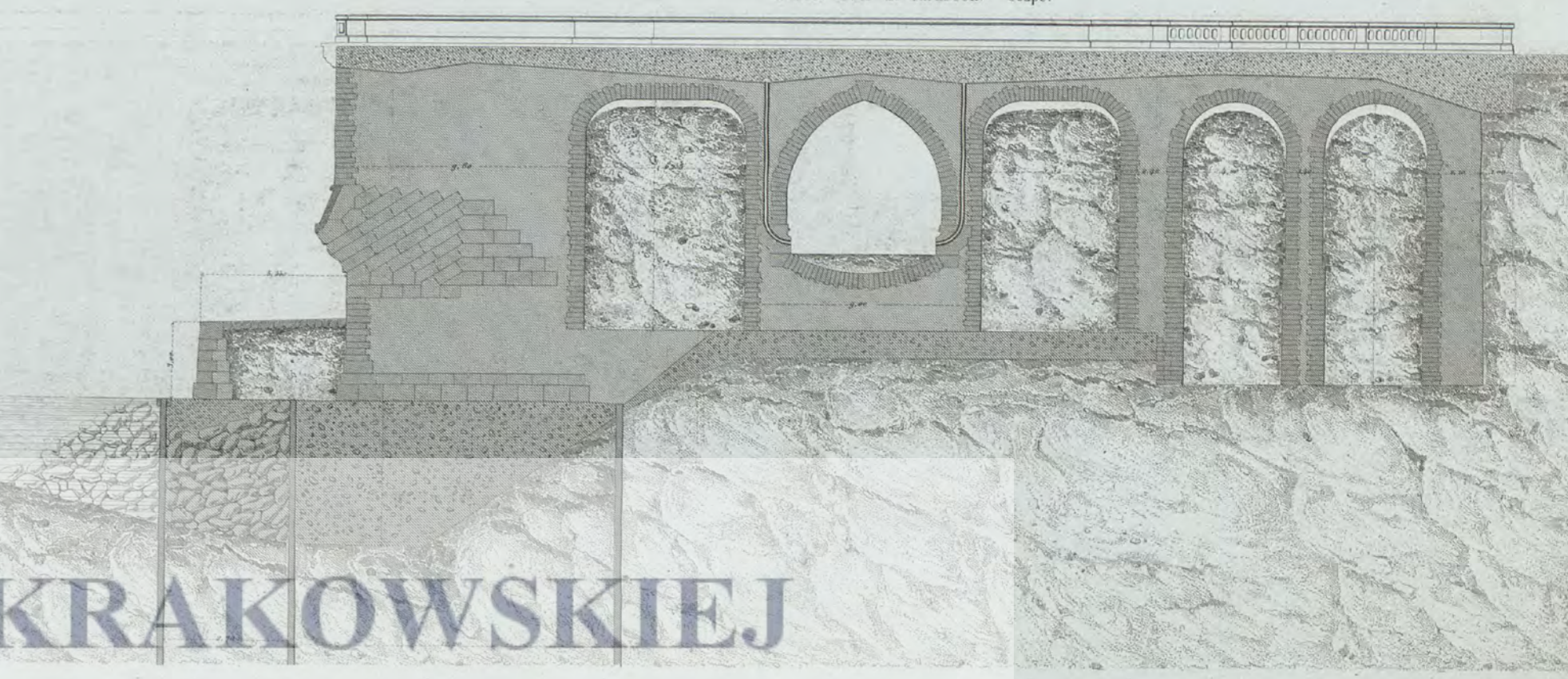
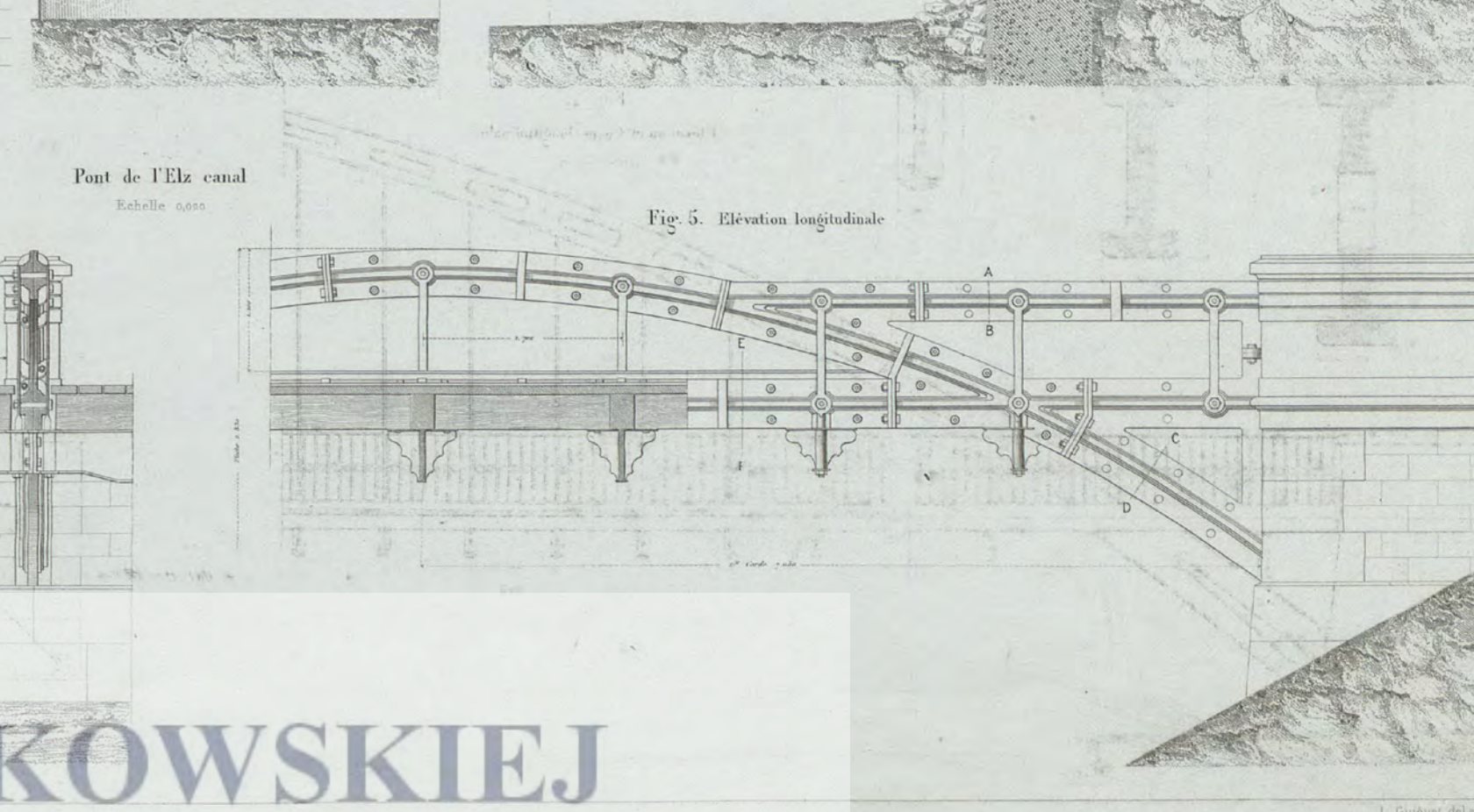
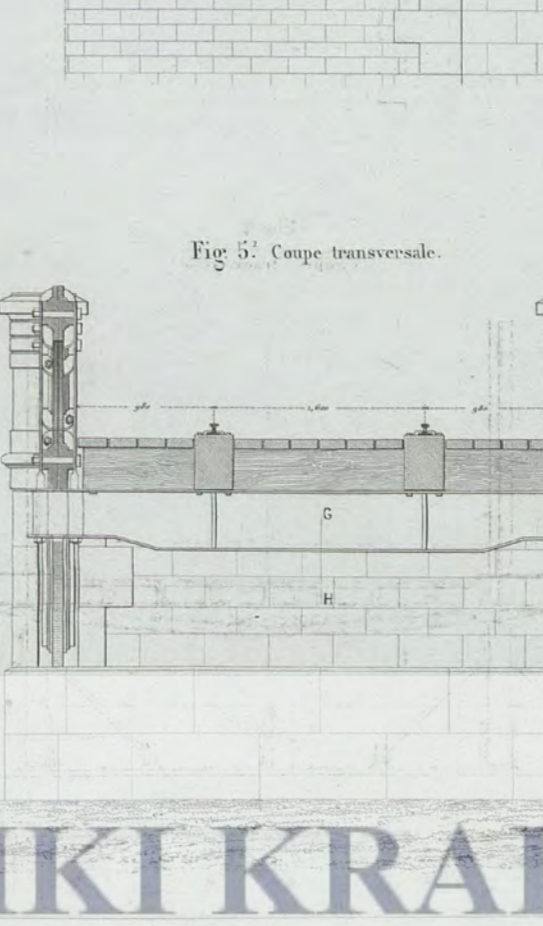
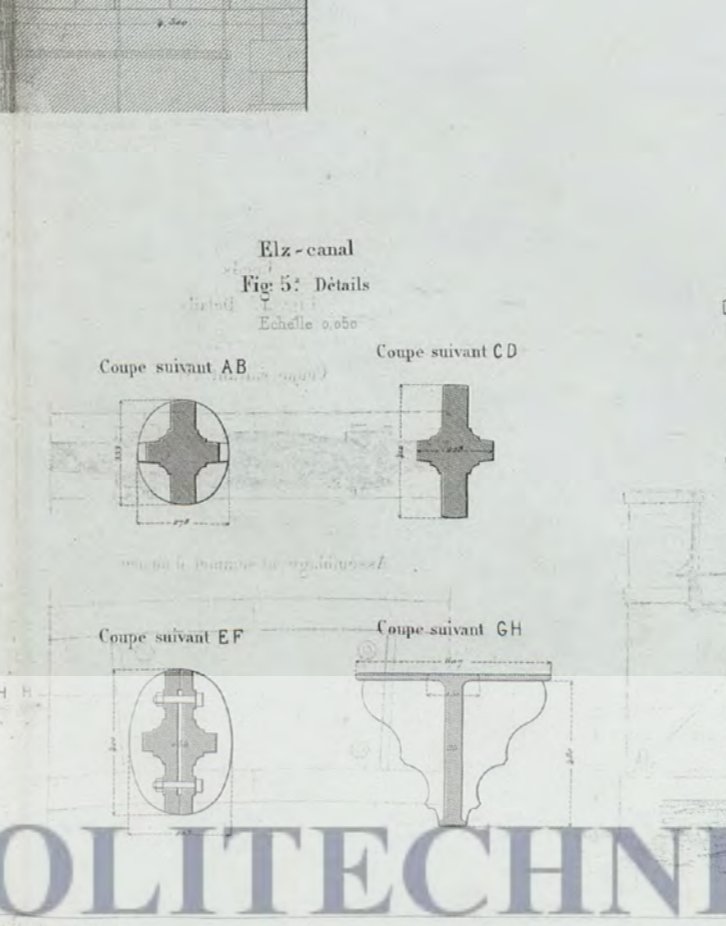
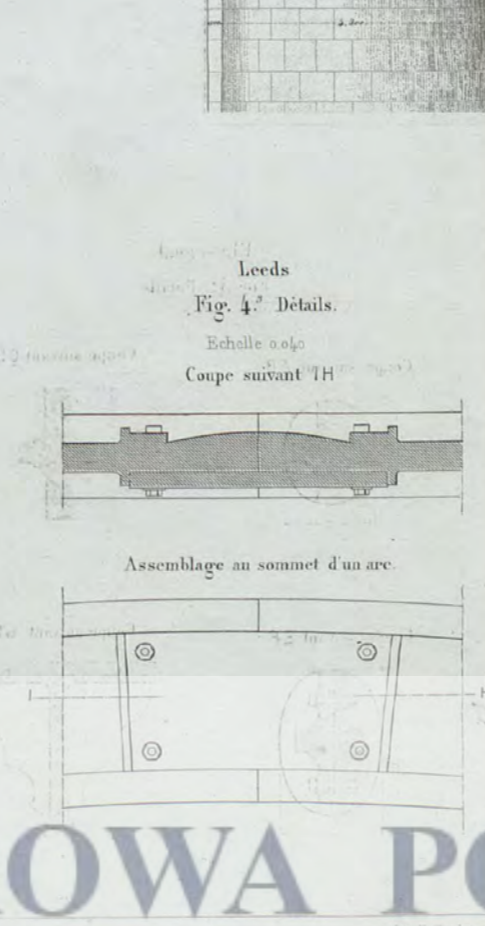
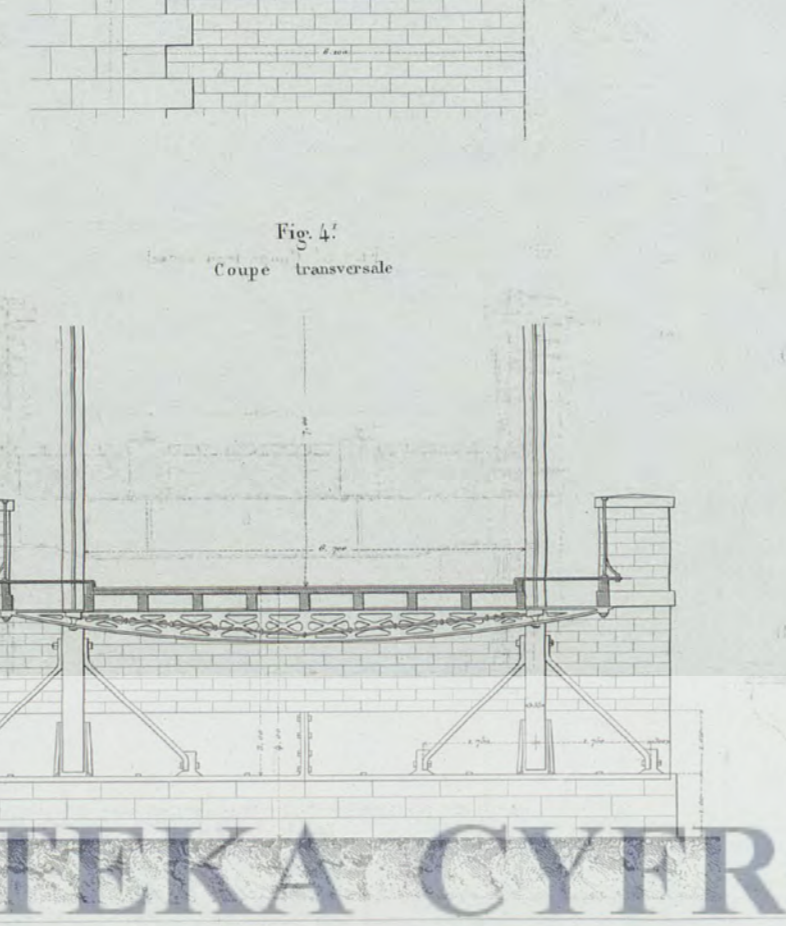
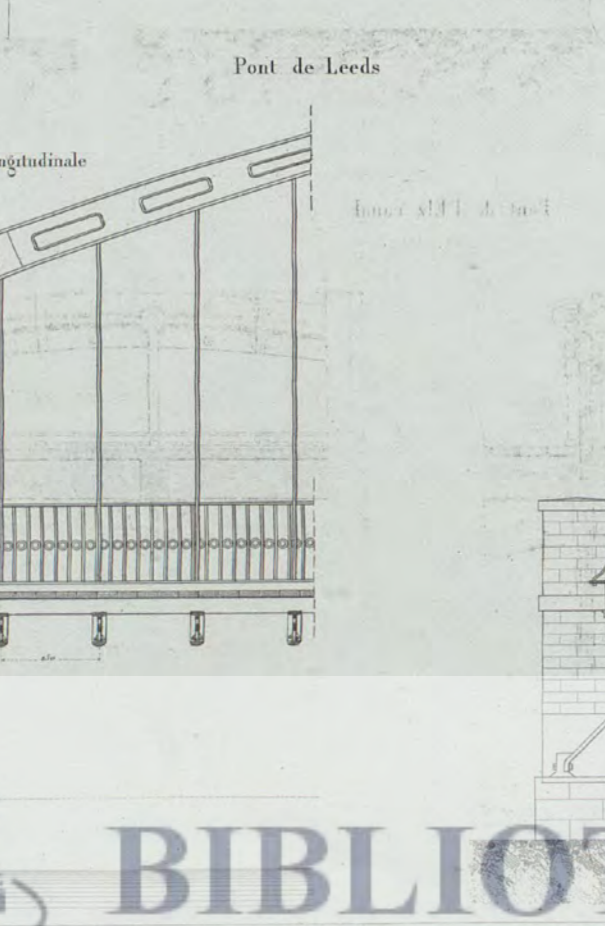
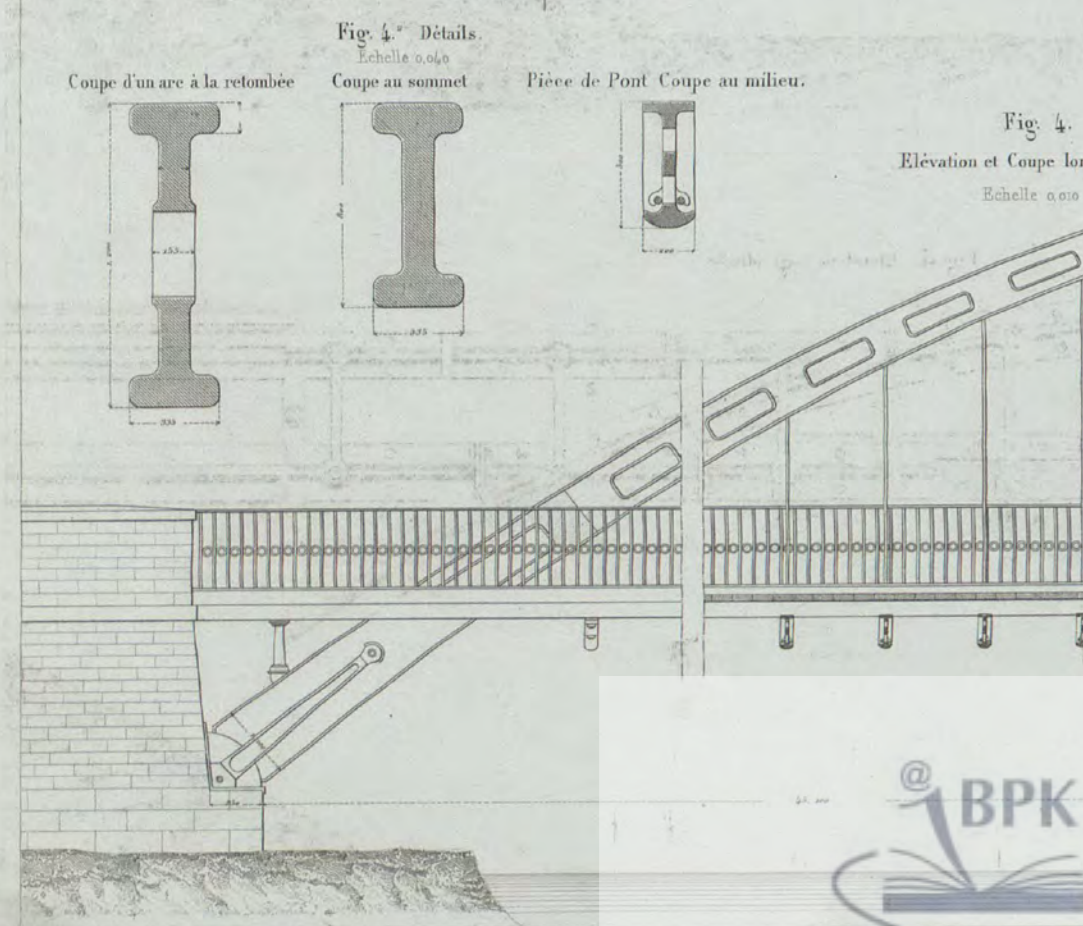
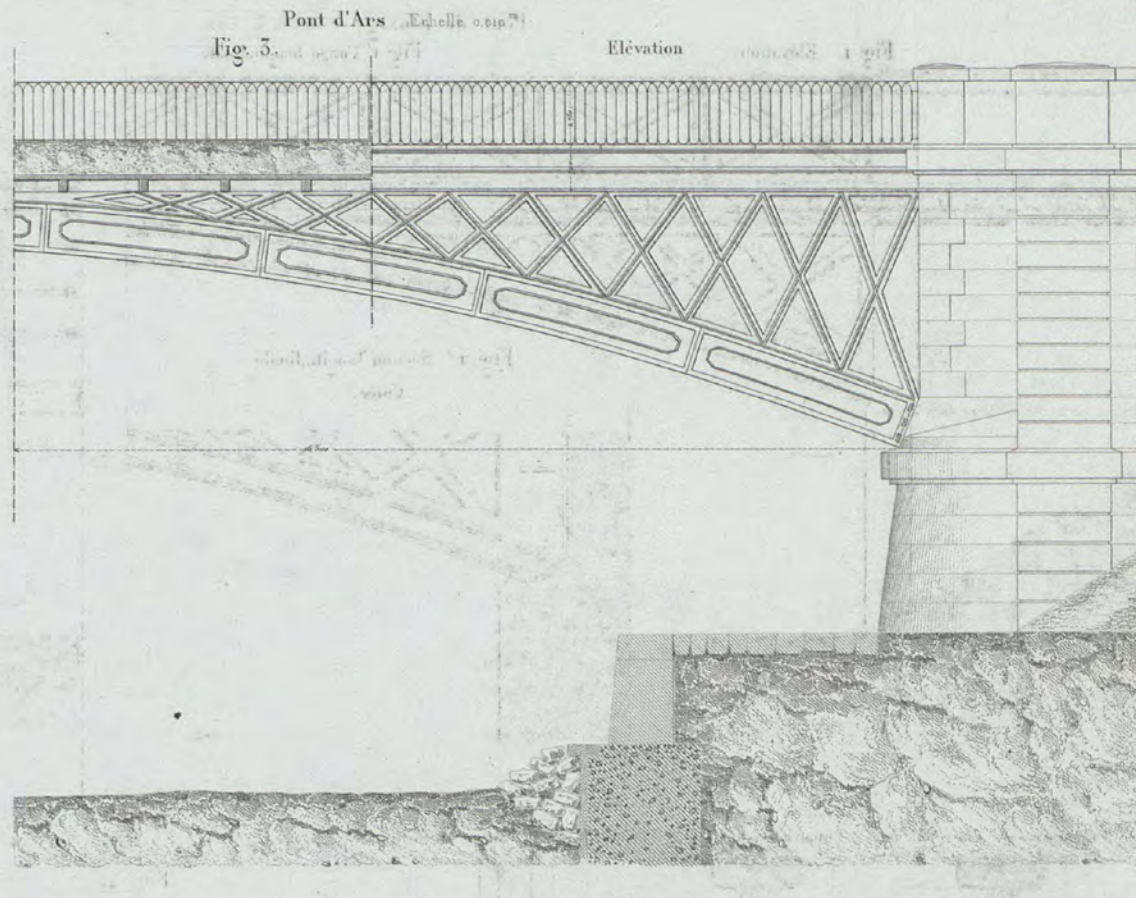
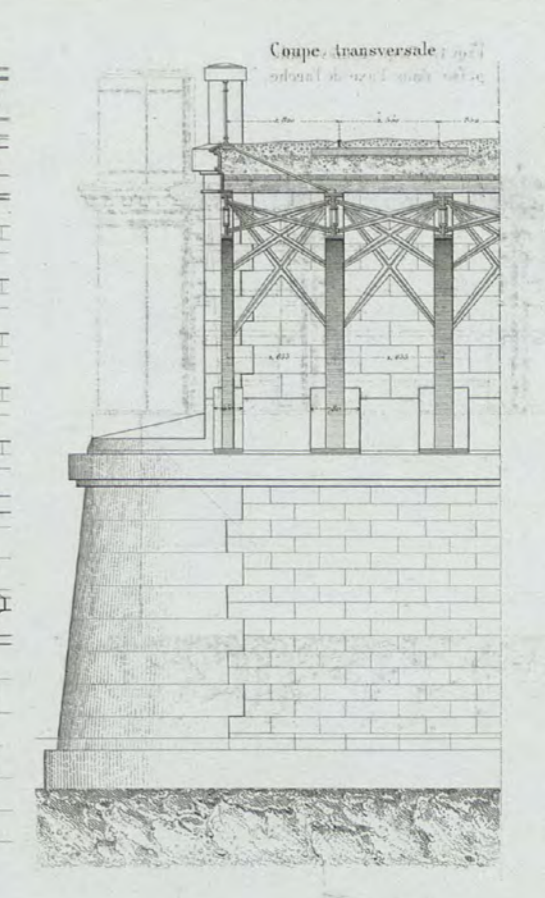
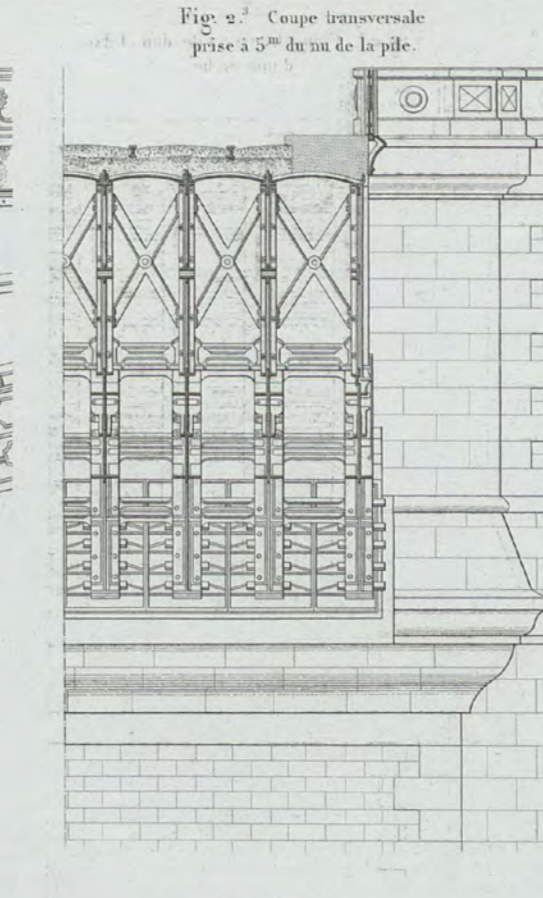
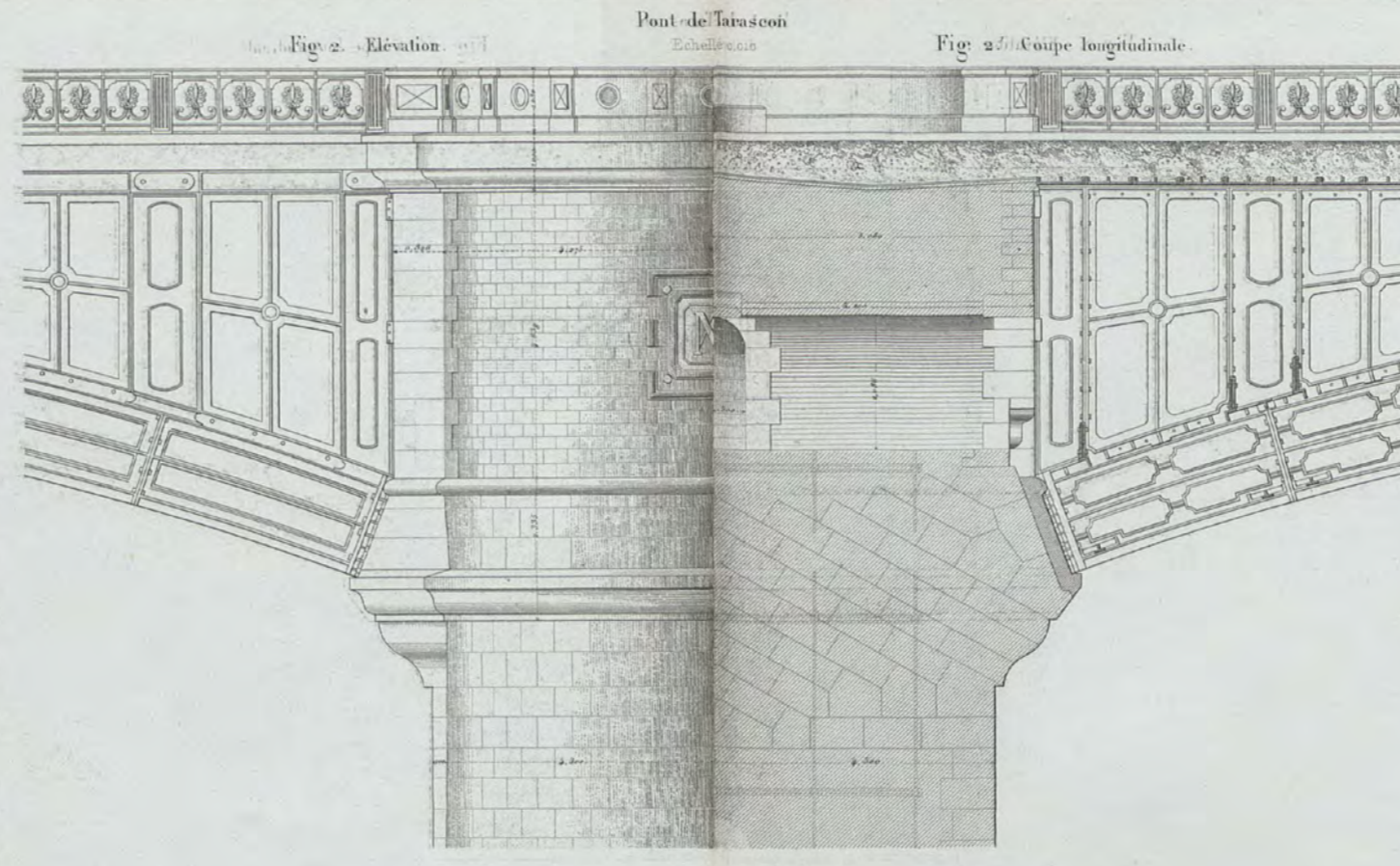
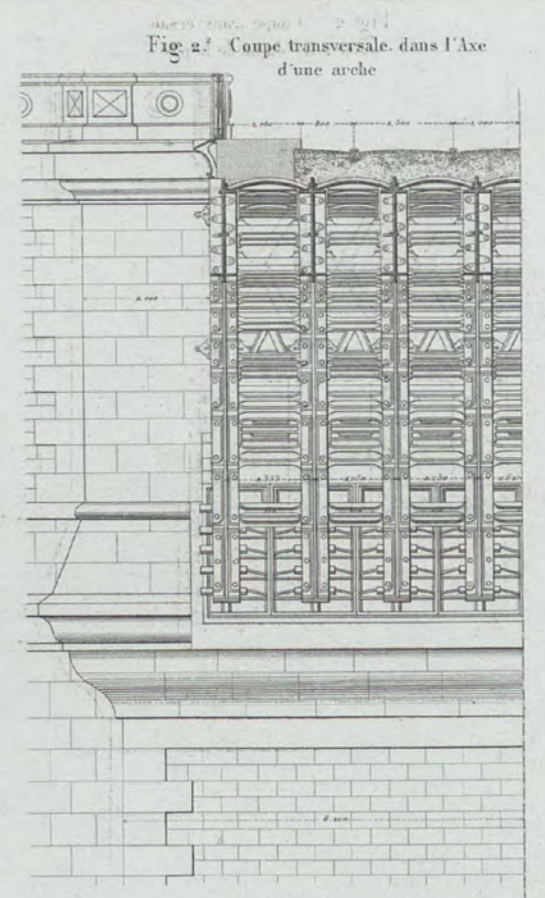
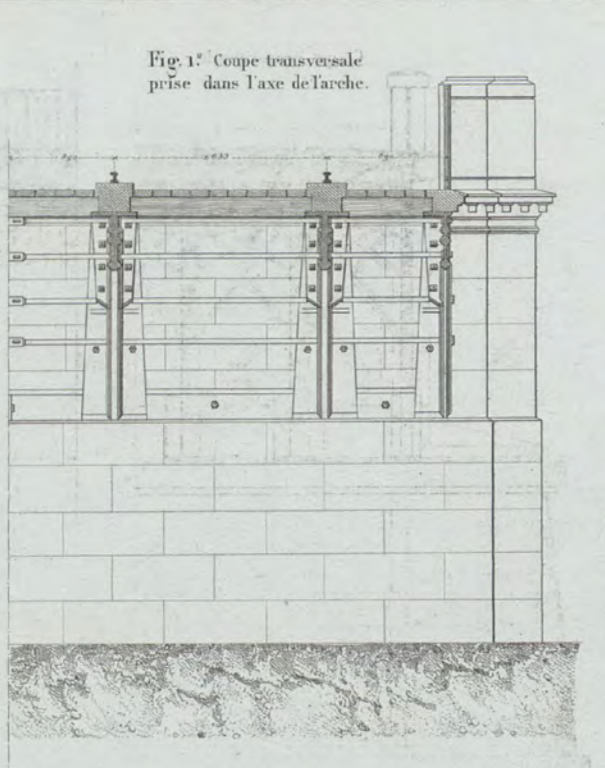
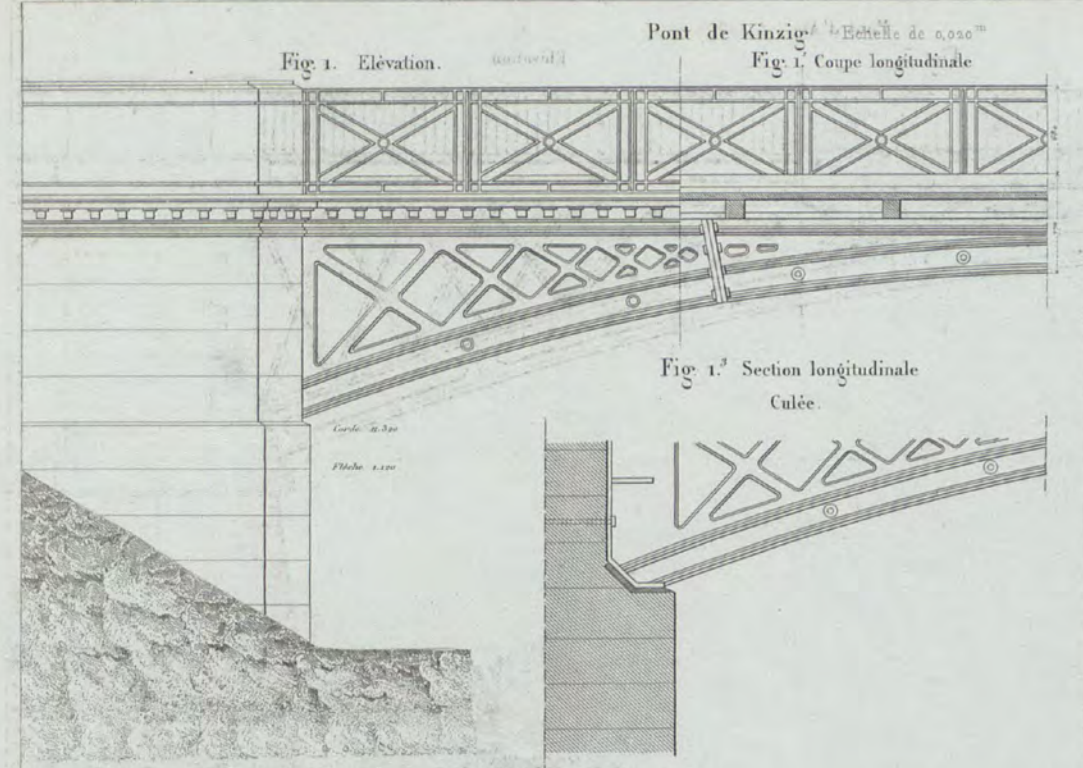

Fig. 5<sup>r</sup>  
Culée. Côté de Tarascon. Coupe.



BIBLIOTEKA CYFROWA POLITECHNIKI KRAKOWSKIEJ

Echelle 1/1000



BIBLIOTEKA CYFROWA POLITECHNIKI KRAKOWSKIEJ

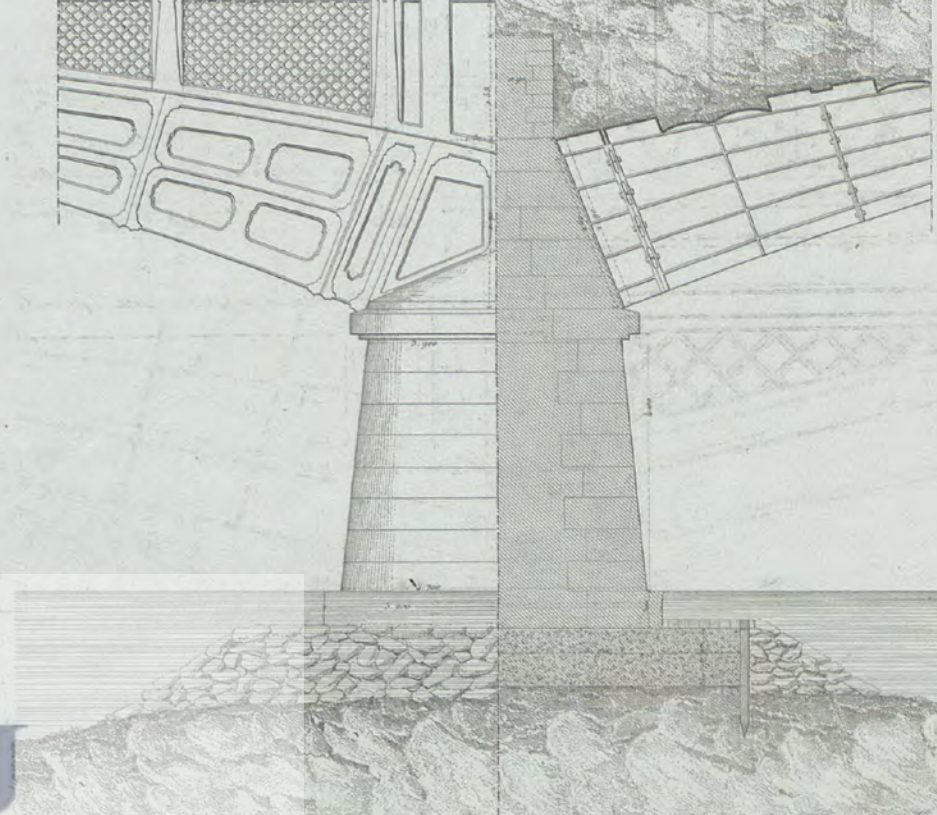
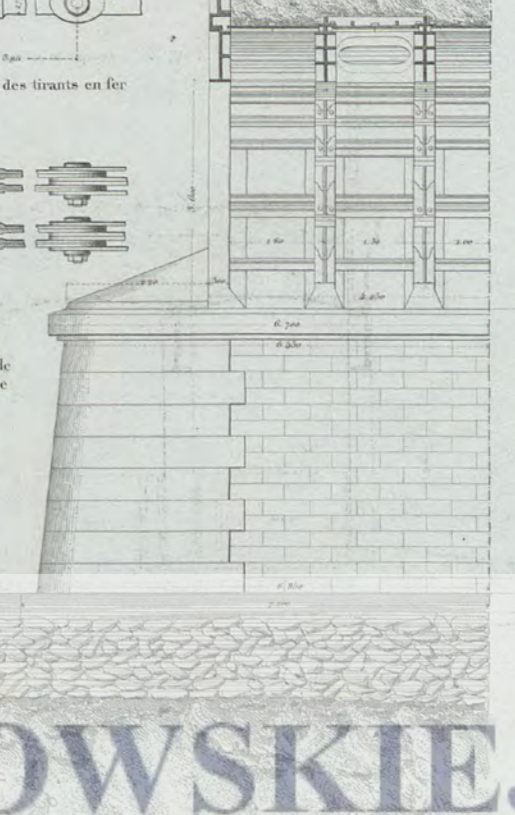
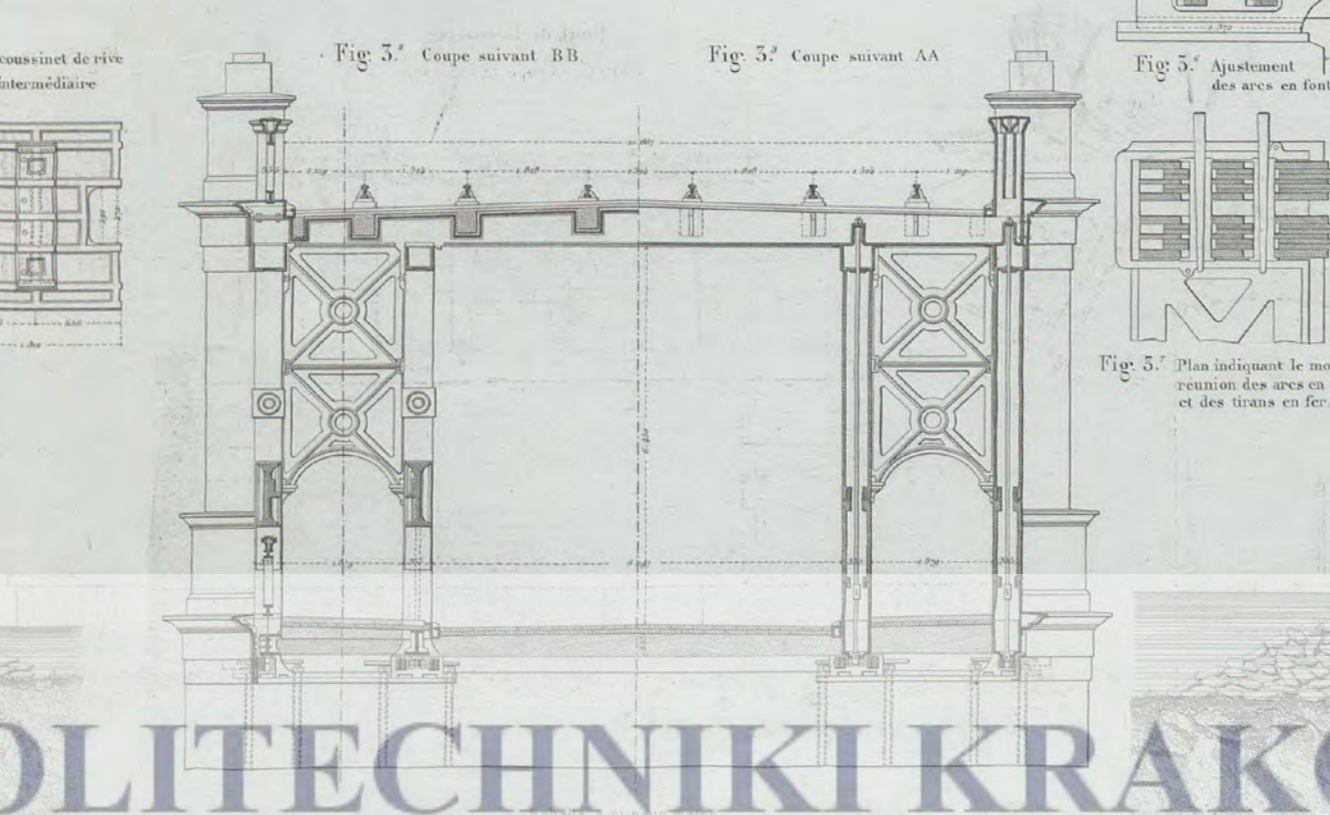
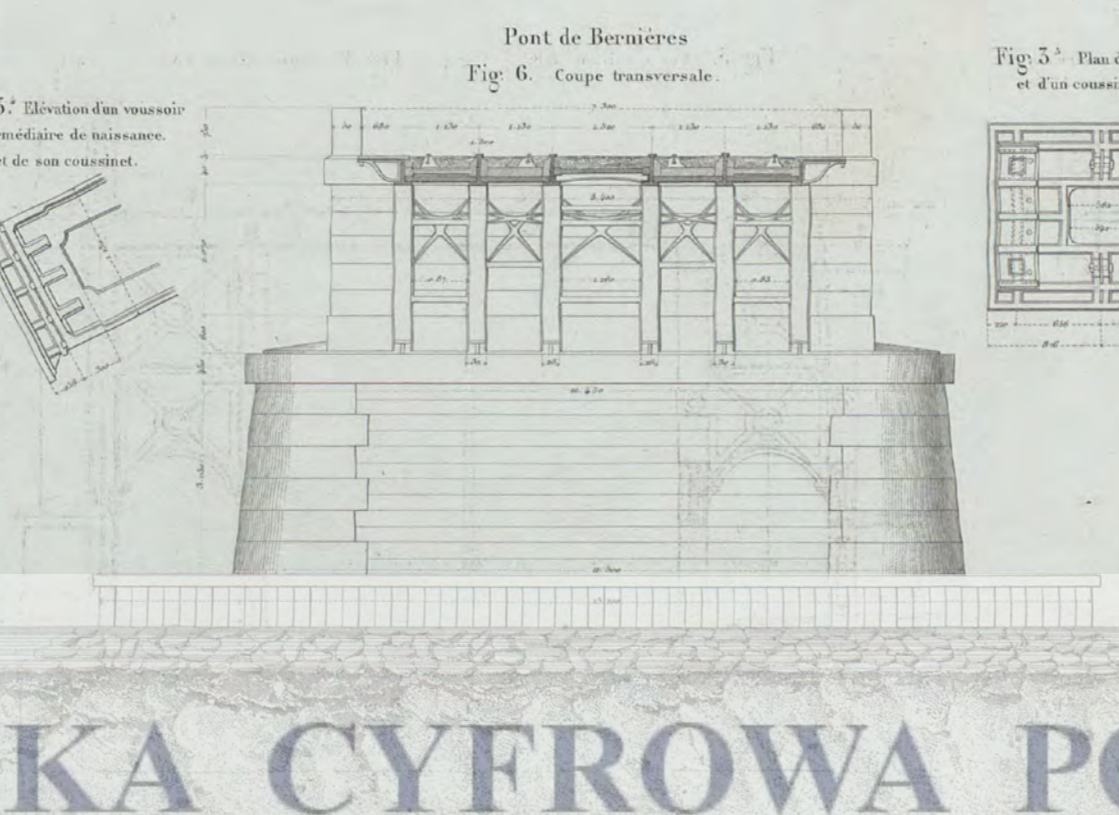
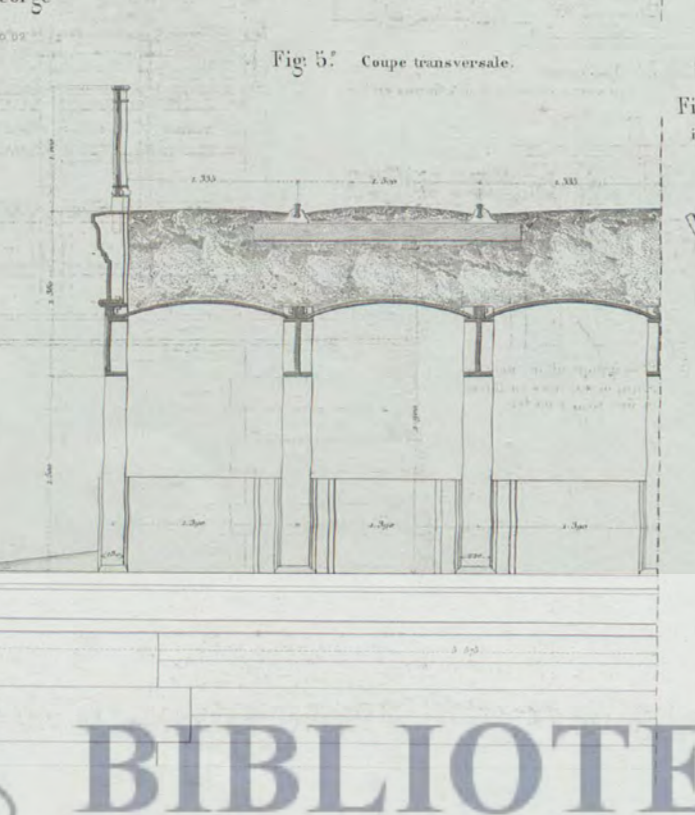
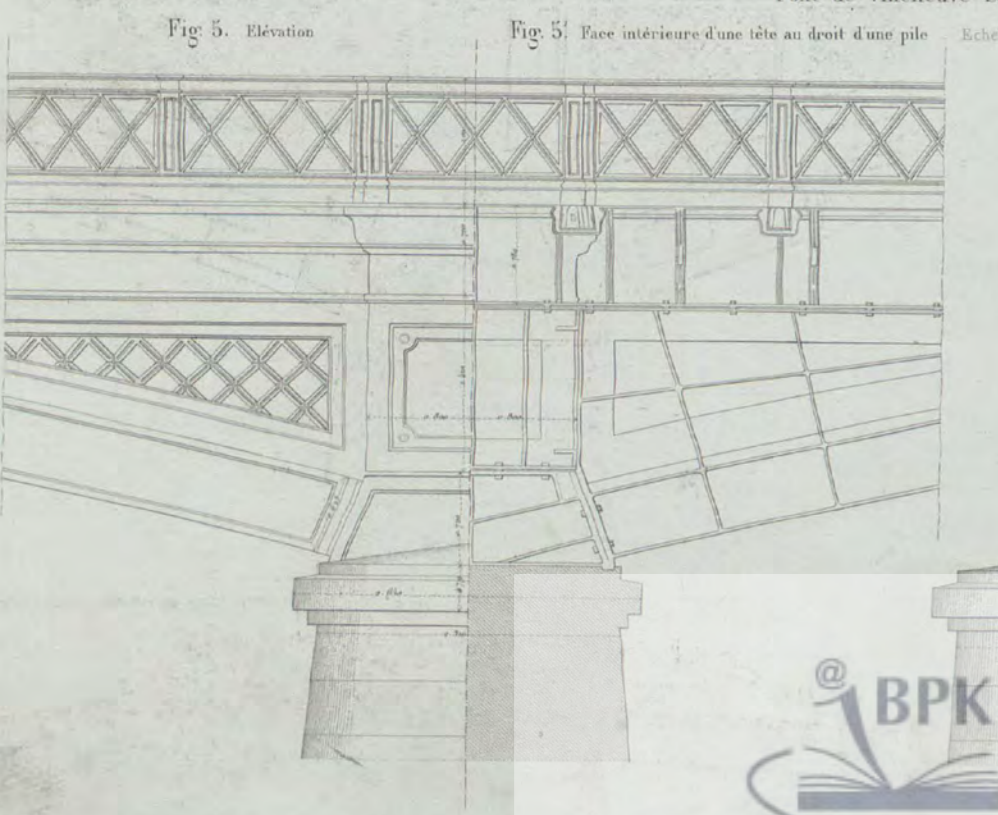
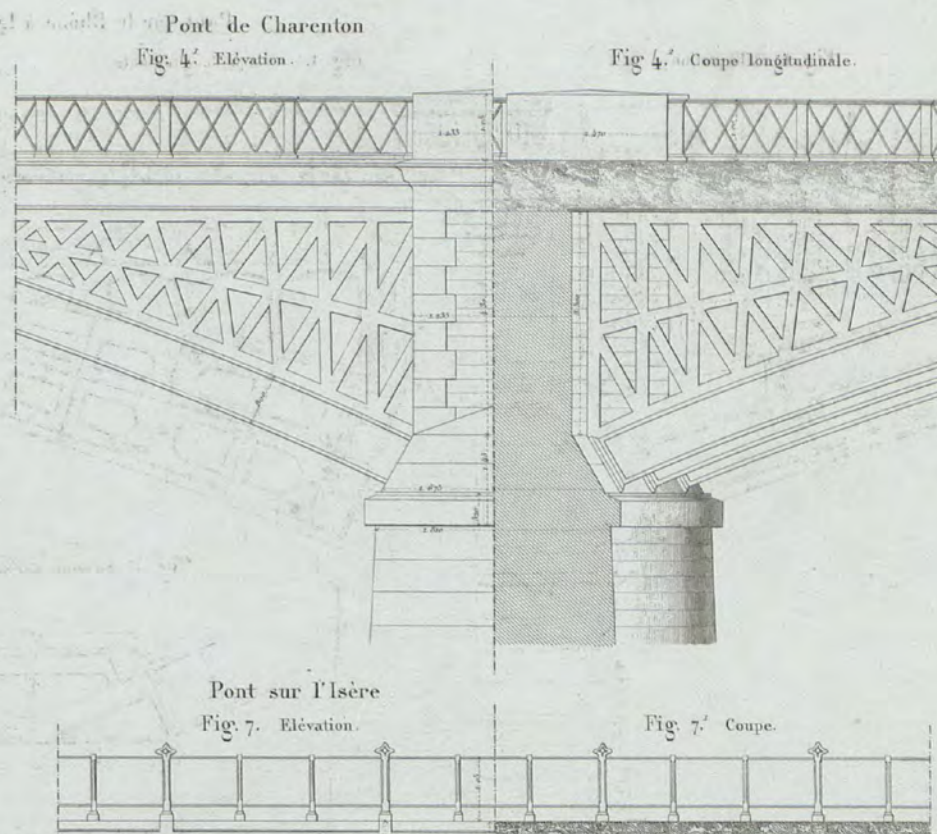
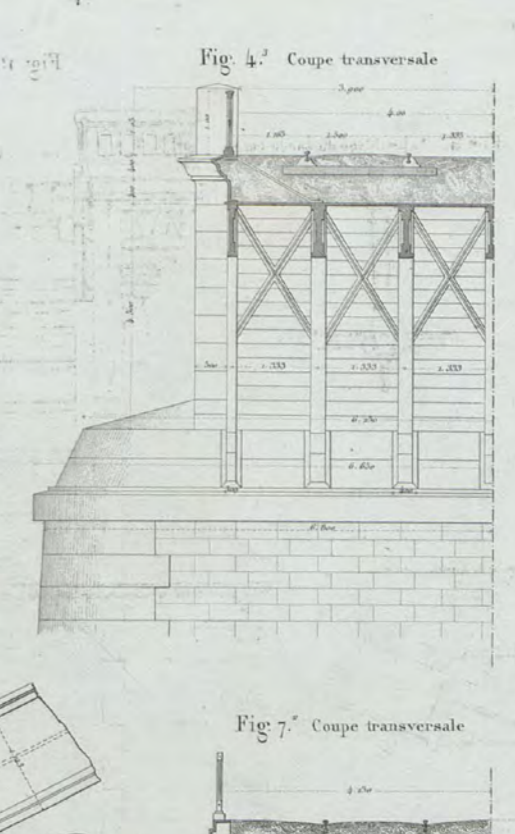
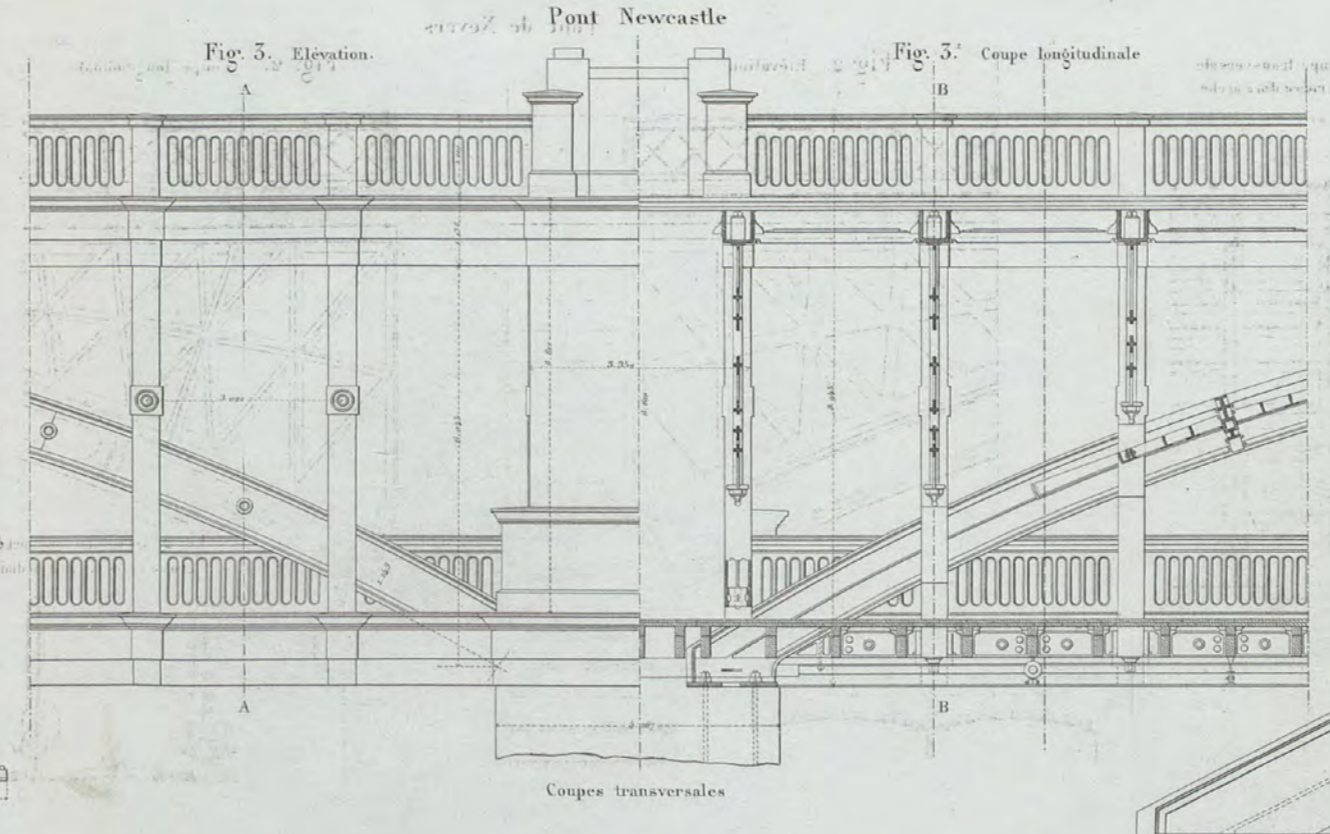
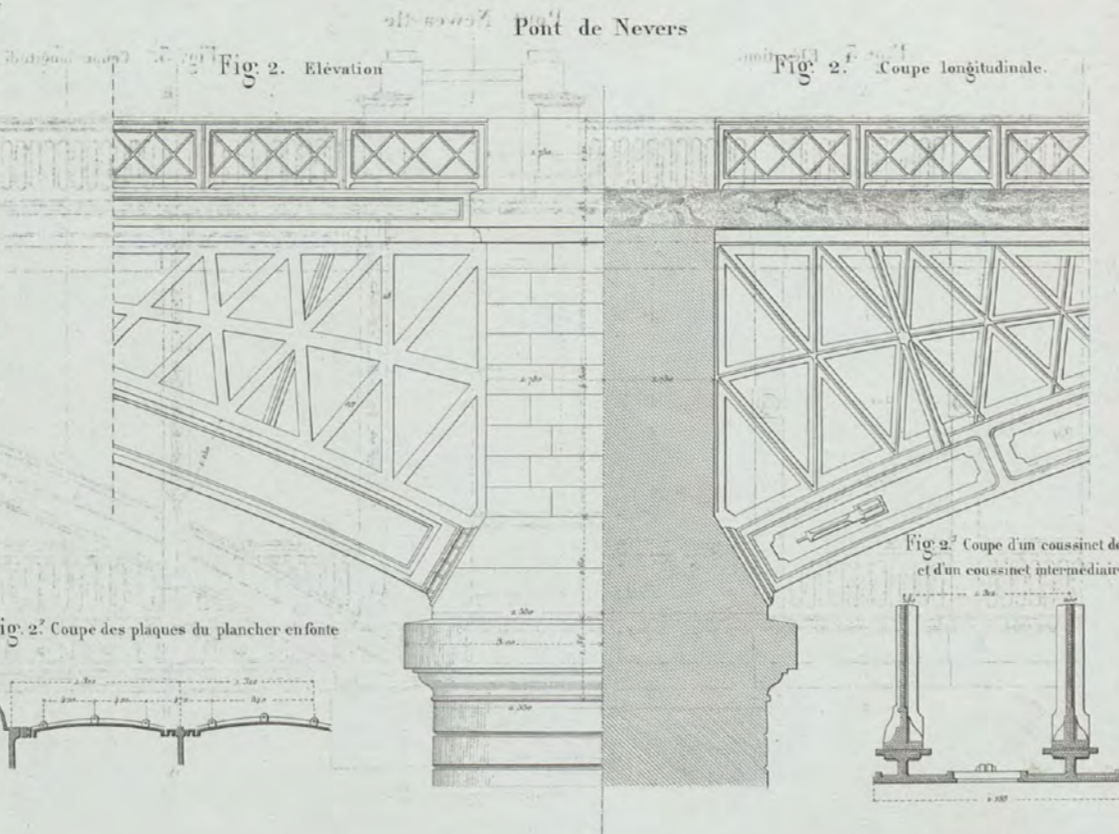
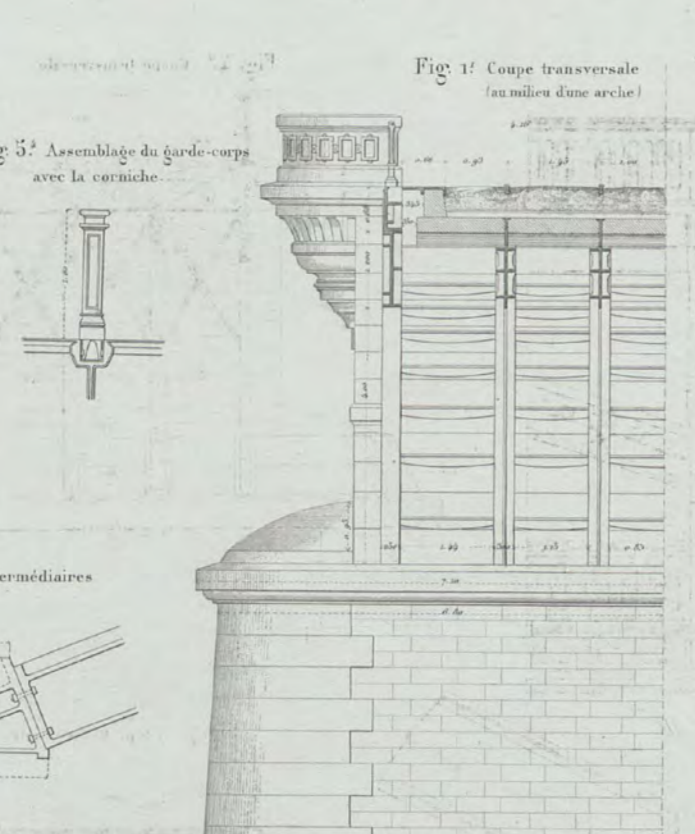
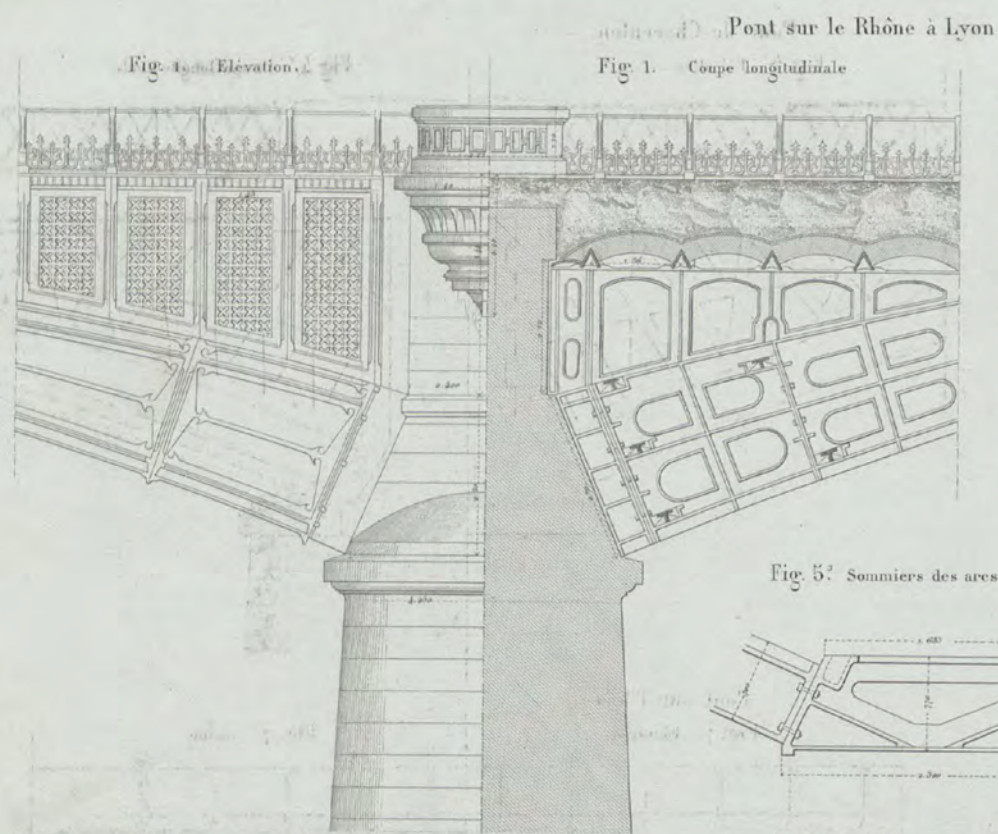

BIBLIOTEKA CYFROWA POLITECHNIKI KRAKOWSKIEJ

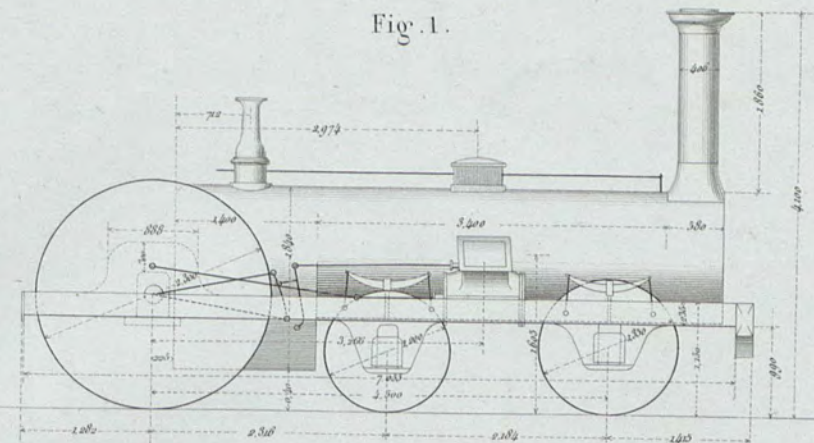

Fig. 1.<sup>1</sup>

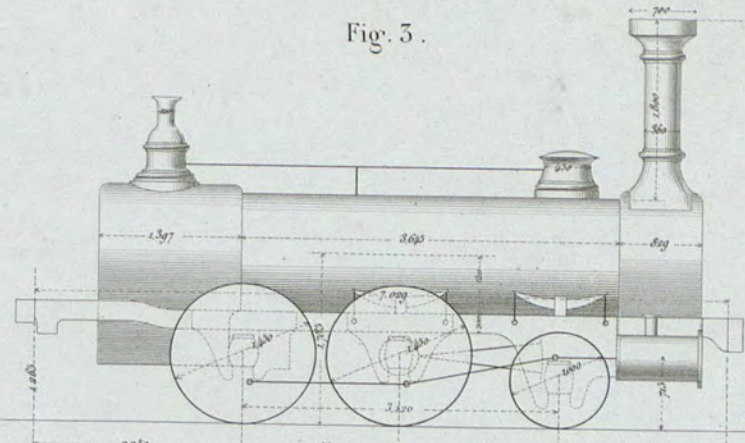
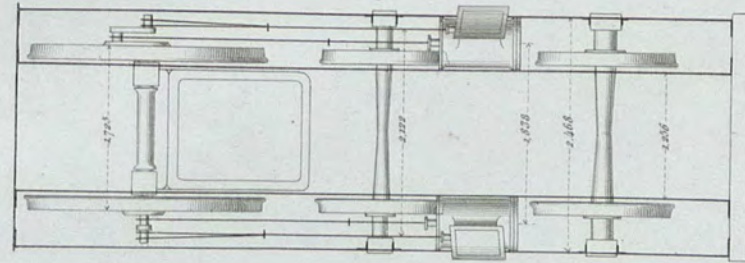

Fig. 3.<sup>1</sup>

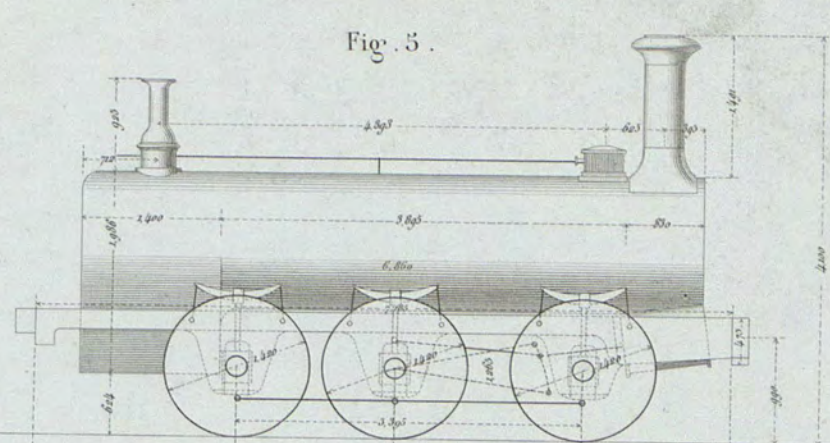
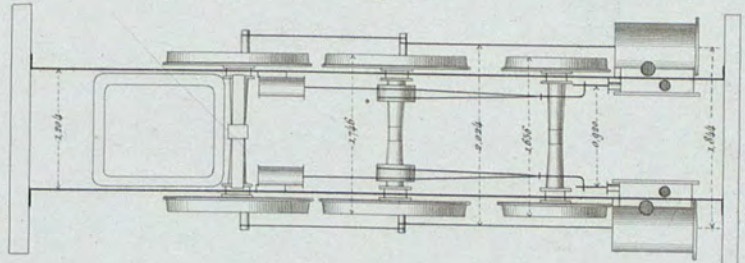

Fig. 5.<sup>1</sup>

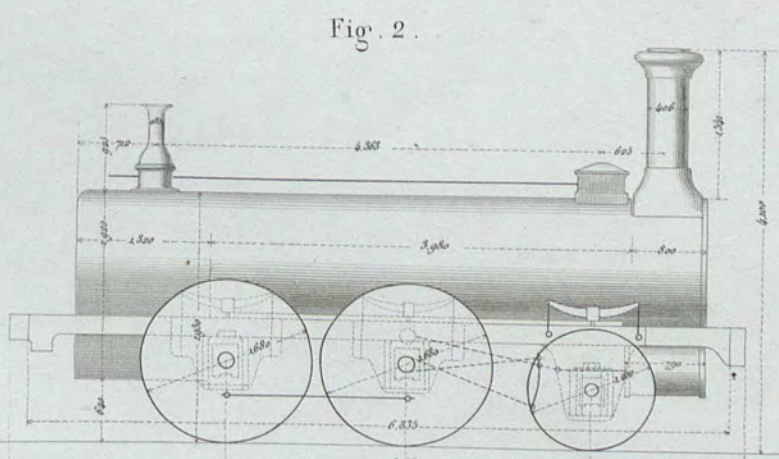
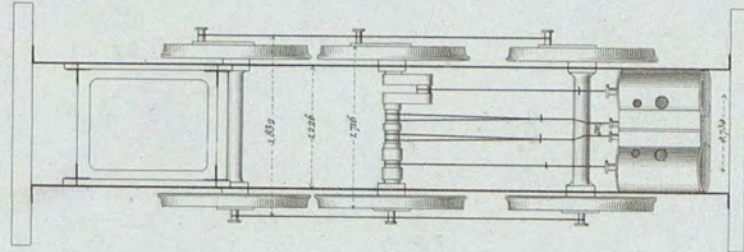

Fig. 2.<sup>1</sup>

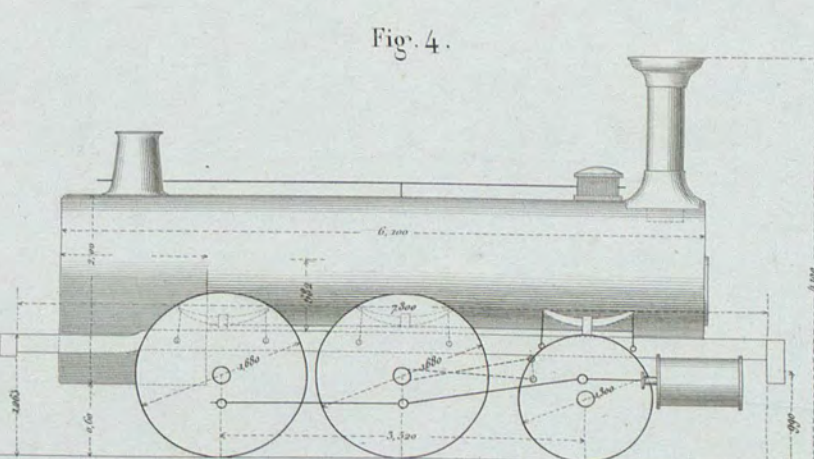
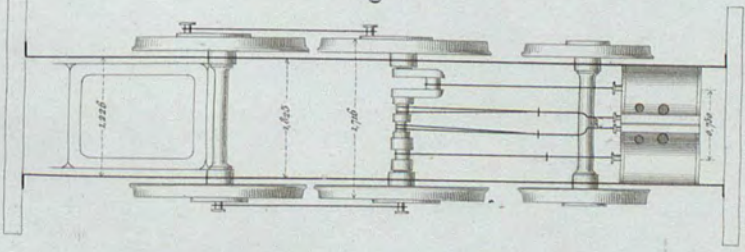

Fig. 4.<sup>1</sup>

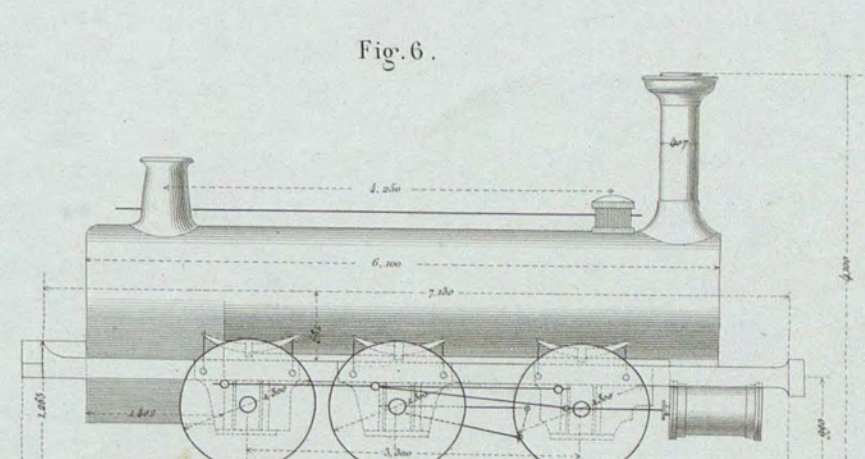
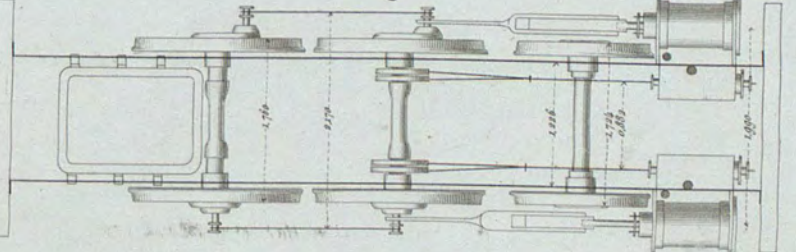
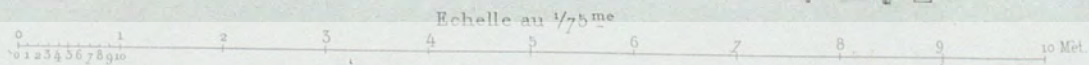
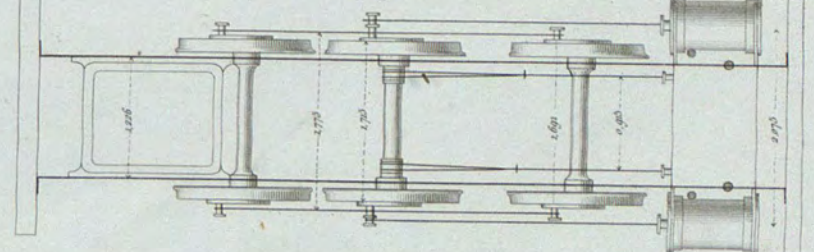

Fig. 6.<sup>1</sup>



A. Jacquin dir.<sup>1</sup>





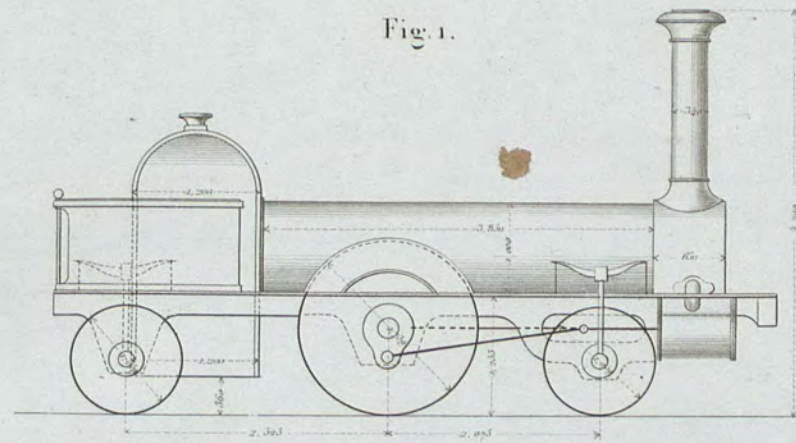

Fig. 1.

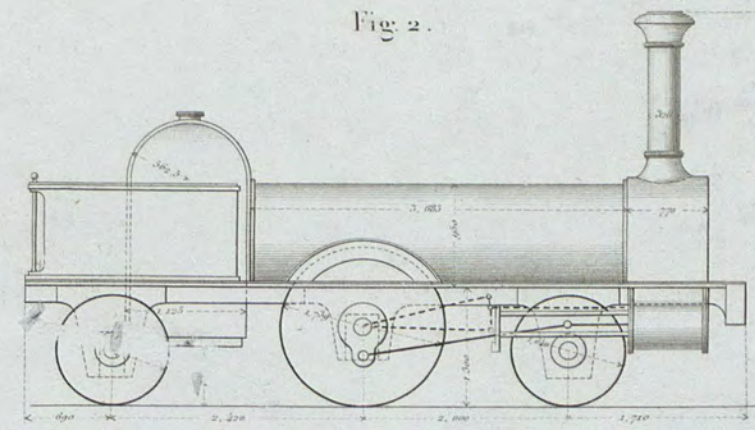

Fig. 2.

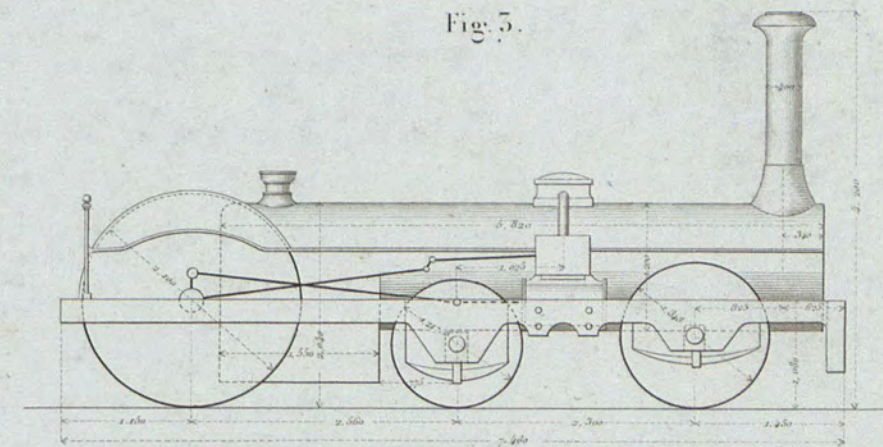

Fig. 3.

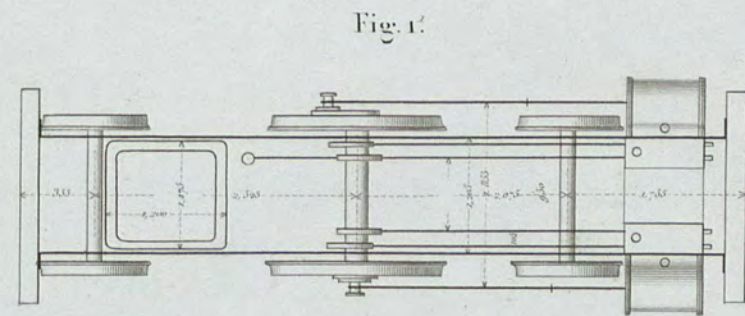

Fig. 1'.

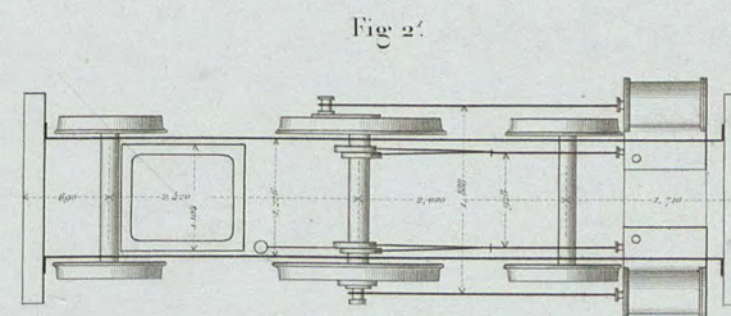

Fig. 2'.

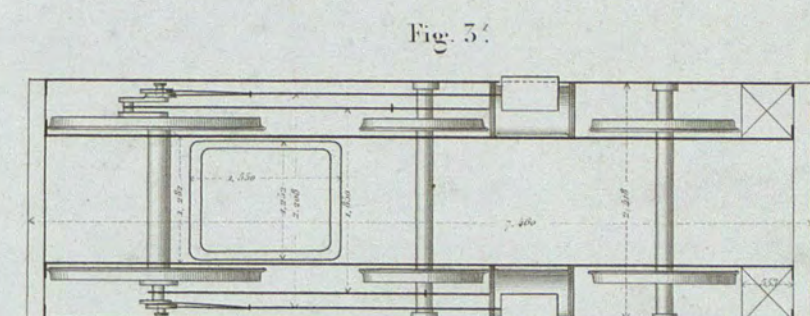

Fig. 3'.

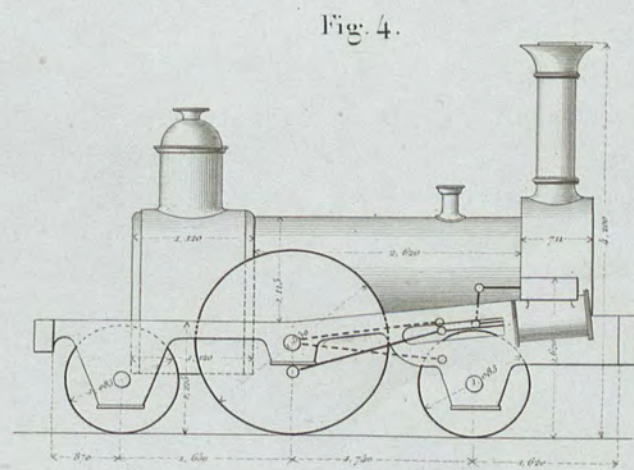

Fig. 4.

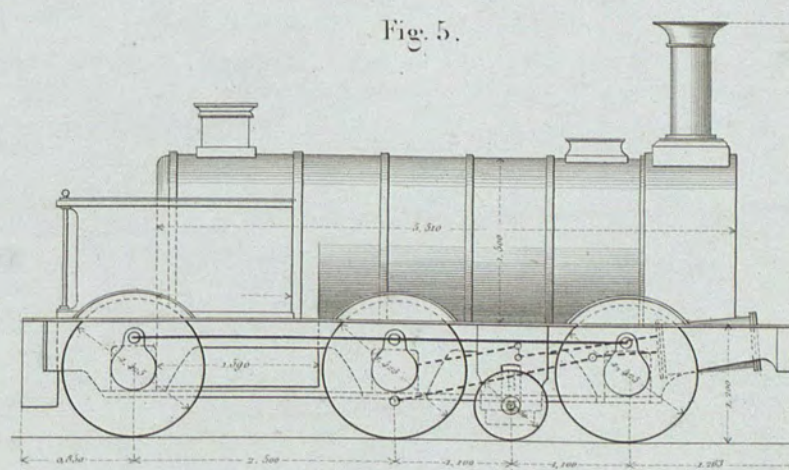

Fig. 5.

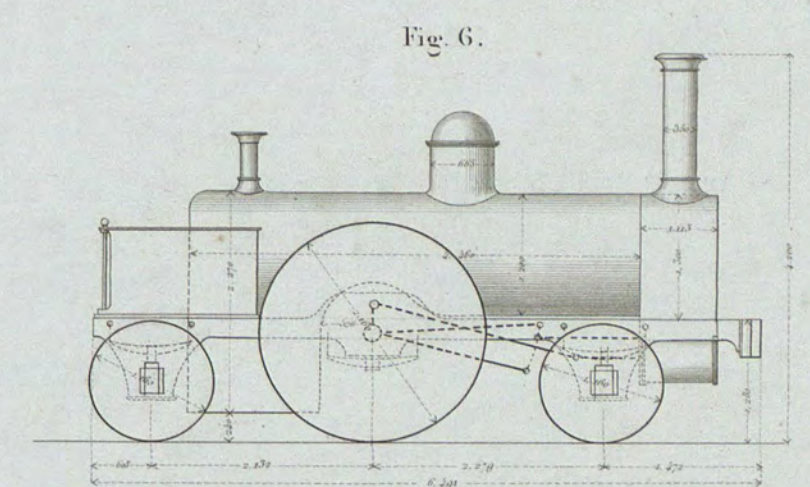

Fig. 6.

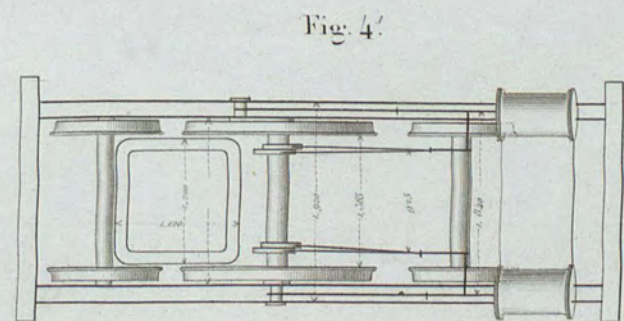

Fig. 4'.

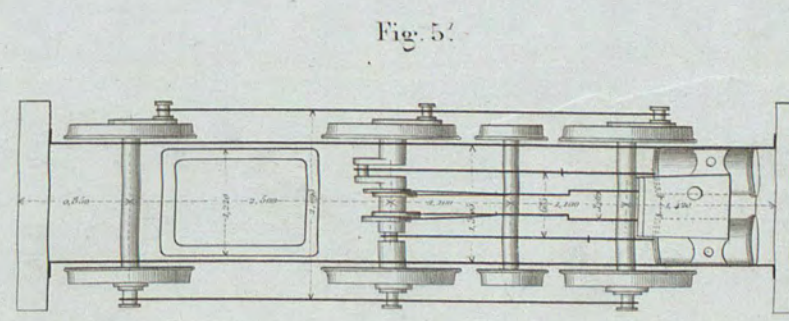

Fig. 5'.

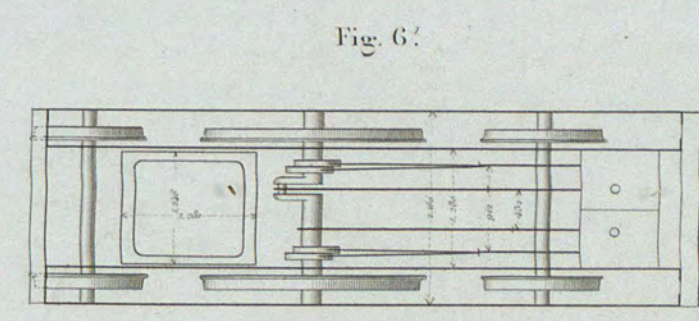

Fig. 6'.

Echelle à 1/50

Nord.

Ardennes.

Fig. 1.

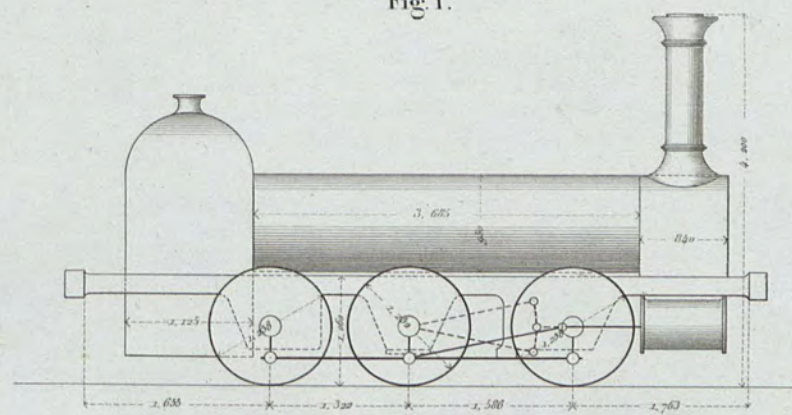

Fig. 2.

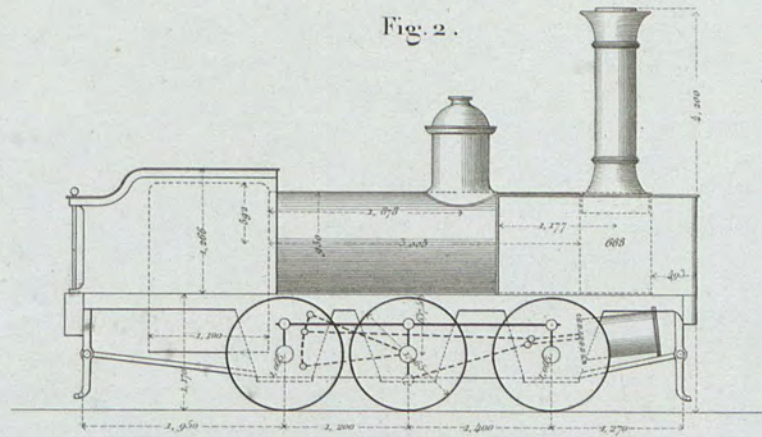

Fig. 5.

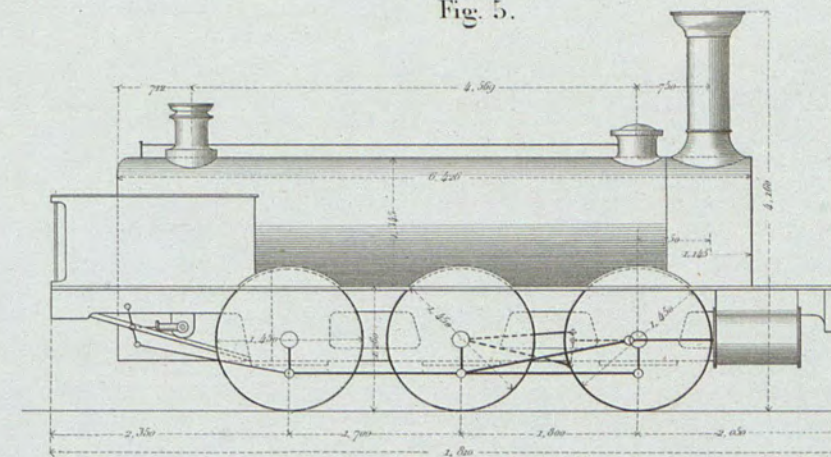

Fig. 1'.

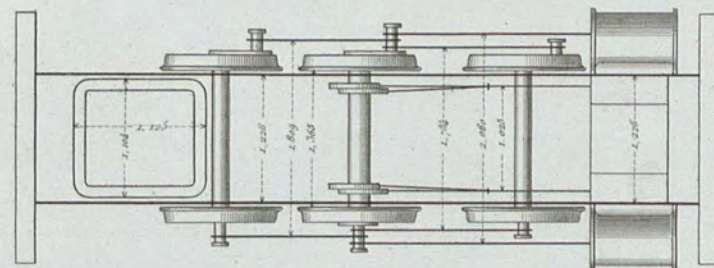

Fig. 2'.

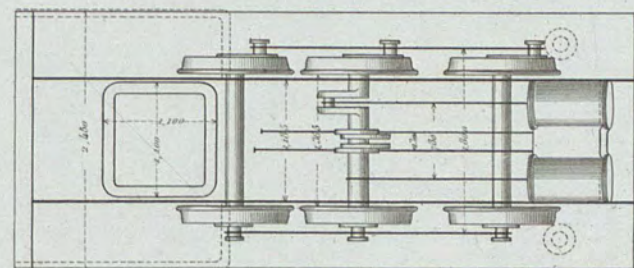

Fig. 5'.

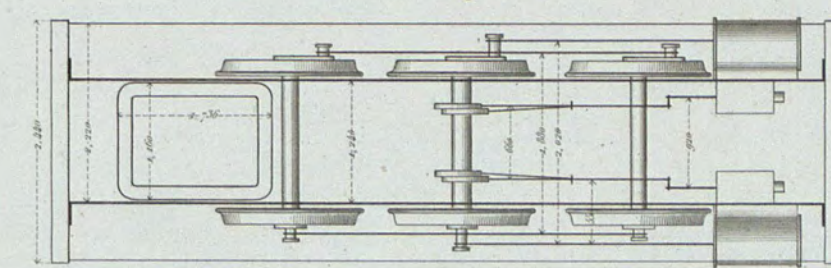

Fig. 3.

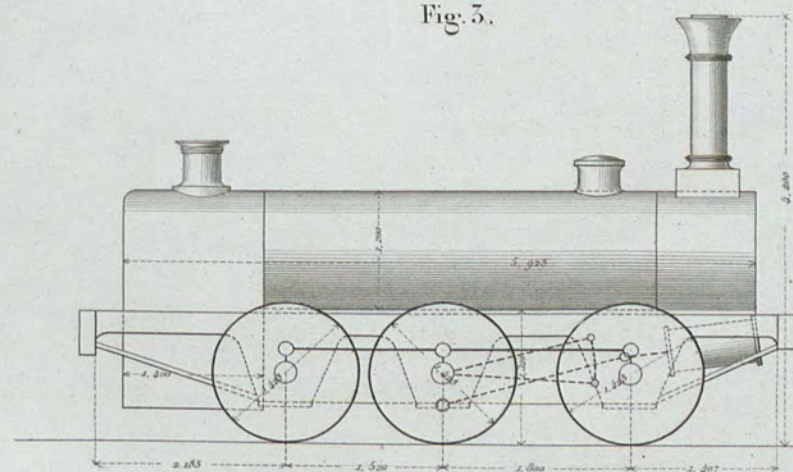

Fig. 4.

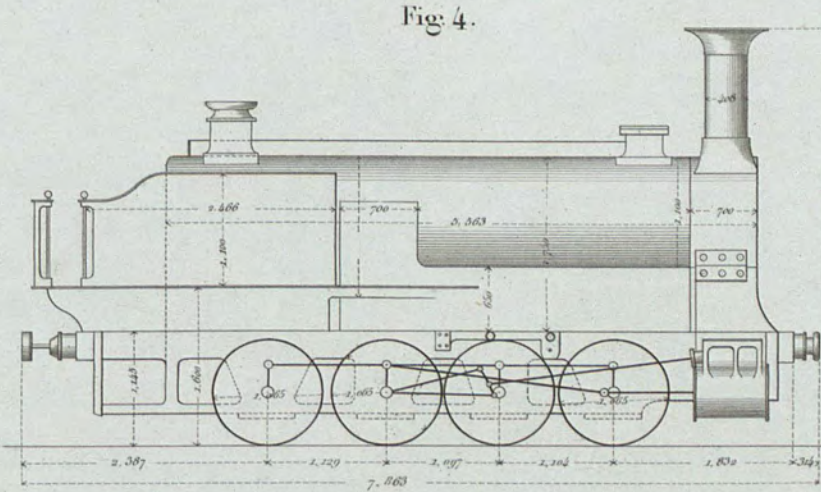

Fig. 6.

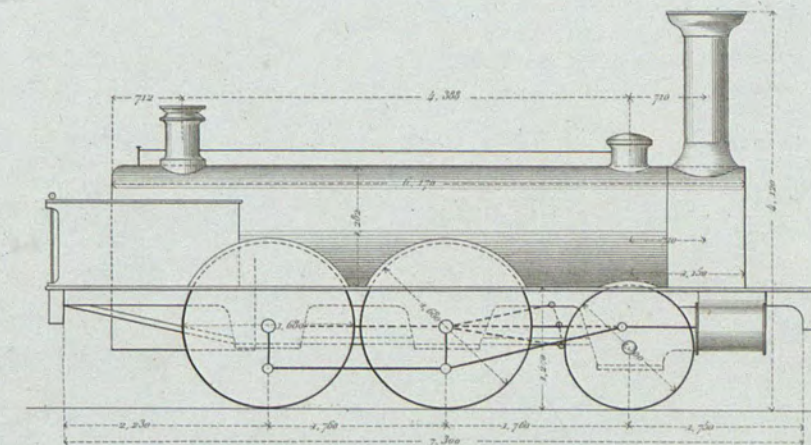

Fig. 3'.

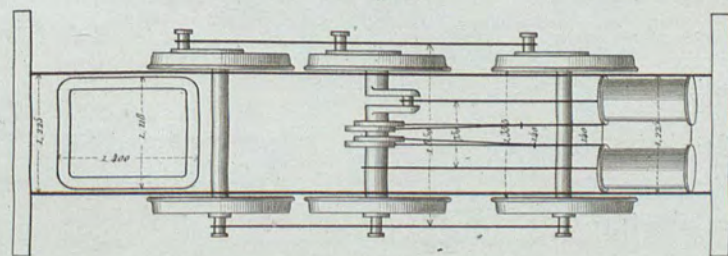

Fig. 4'.

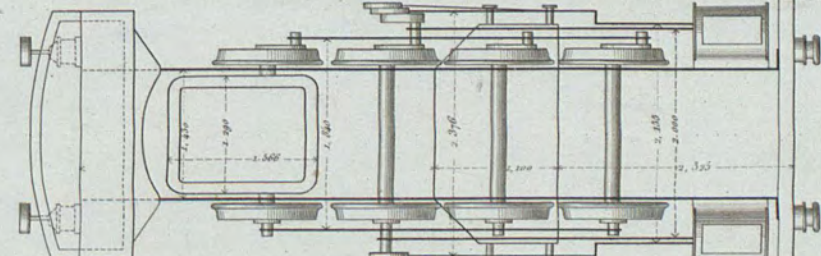
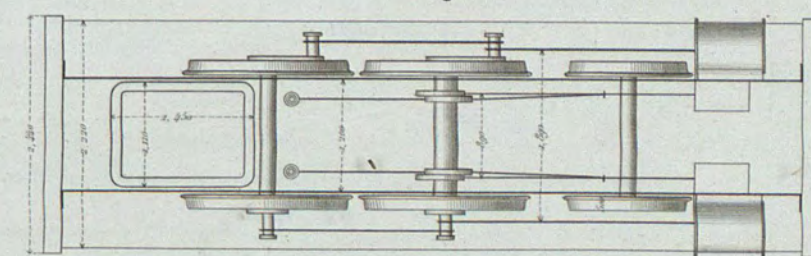

Fig. 6'.



Echelle a 1/75<sup>e</sup>

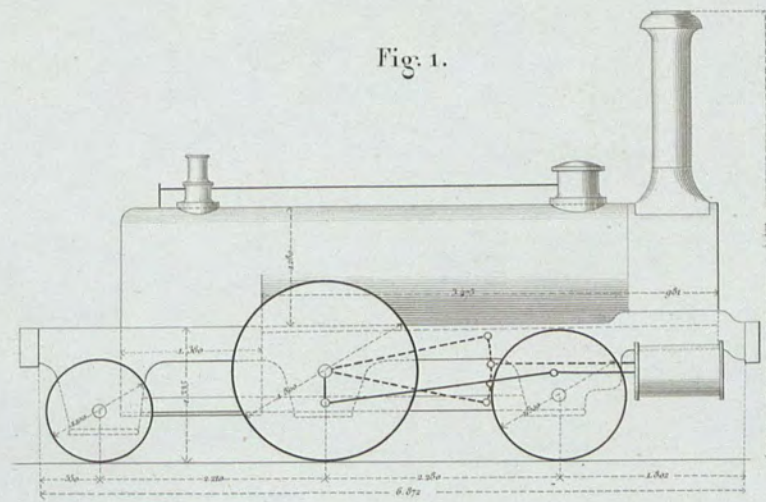

Fig. 1.

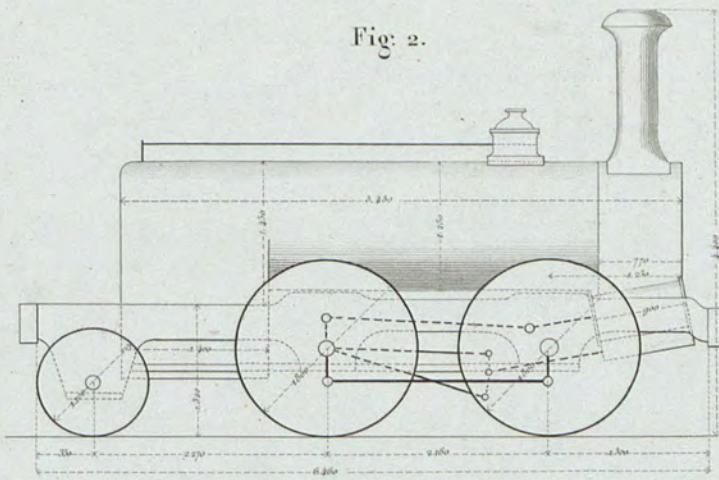

Fig. 2.

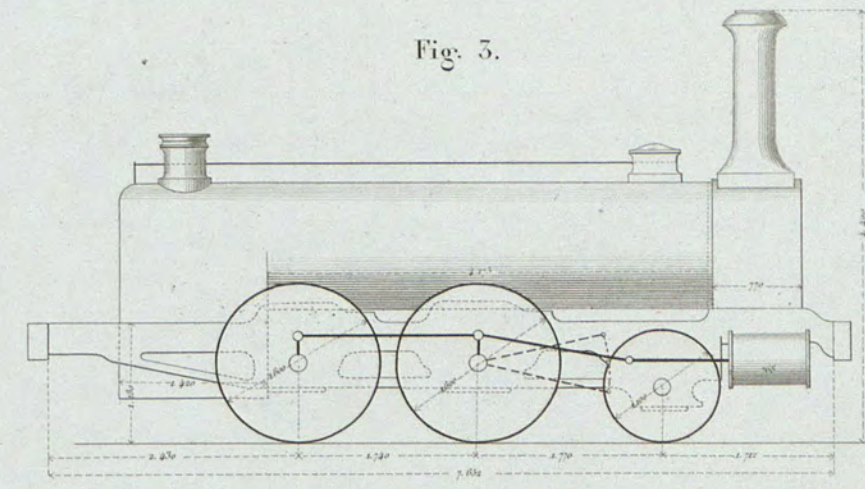

Fig. 5.

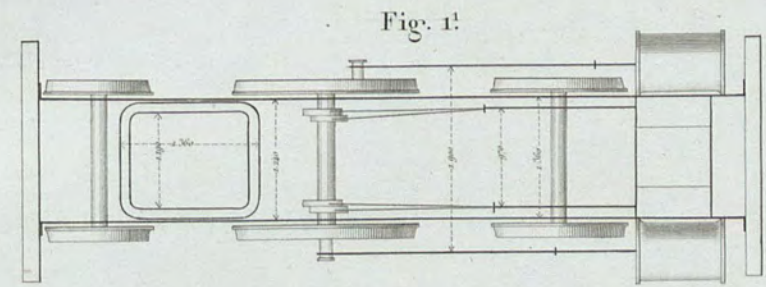

Fig. 1'

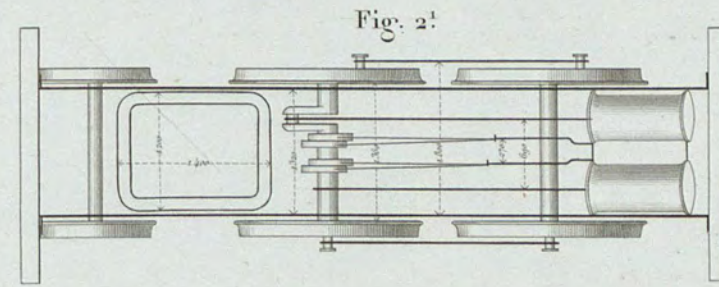

Fig. 2'

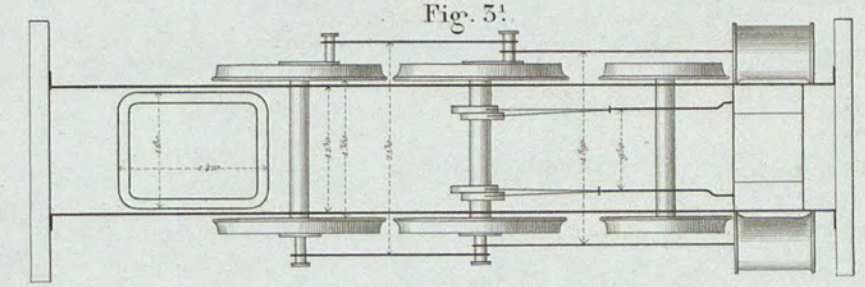

Fig. 5'

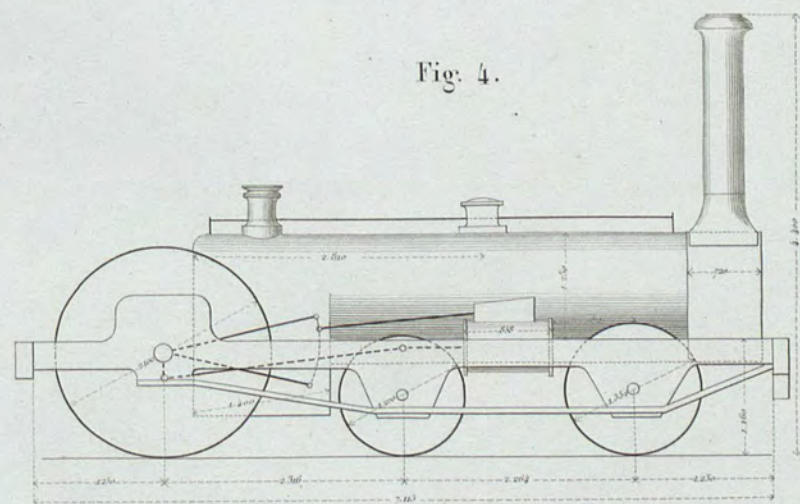

Fig. 4.

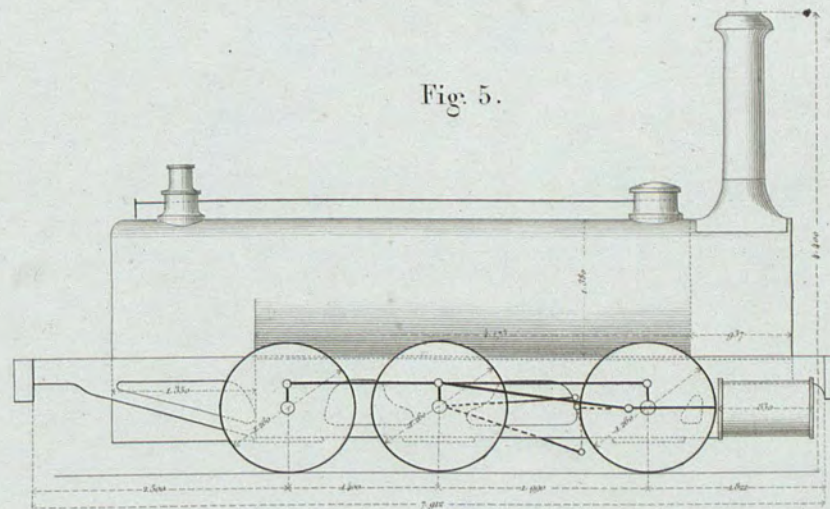

Fig. 5.

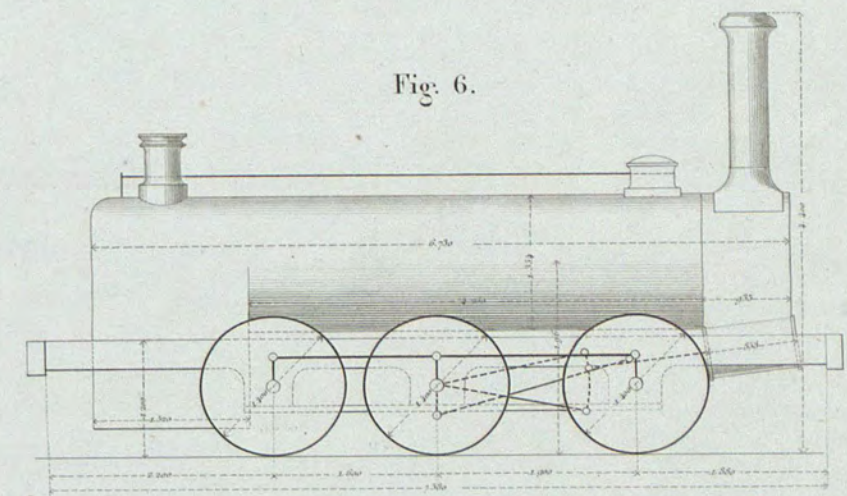

Fig. 6.

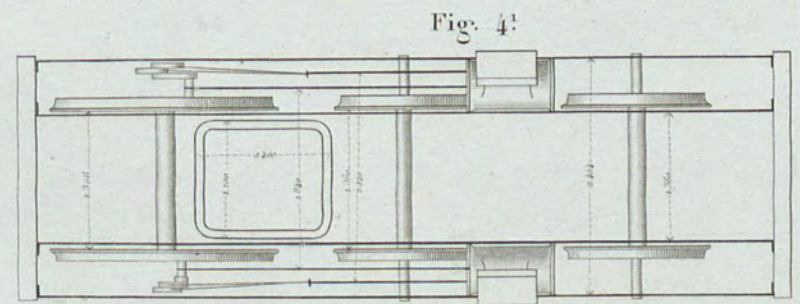

Fig. 4'

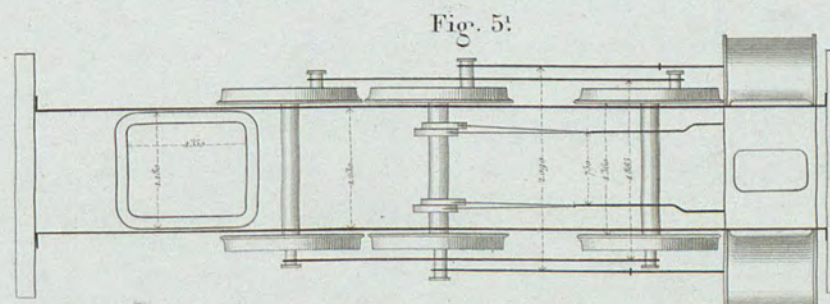

Fig. 5'

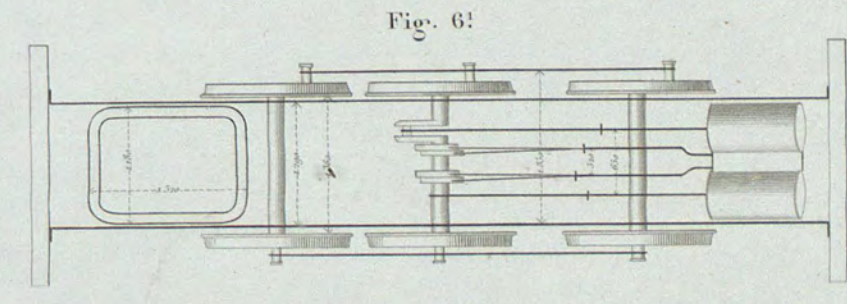

Fig. 6'

Echelle 1/75<sup>me</sup>



Fig. 1.

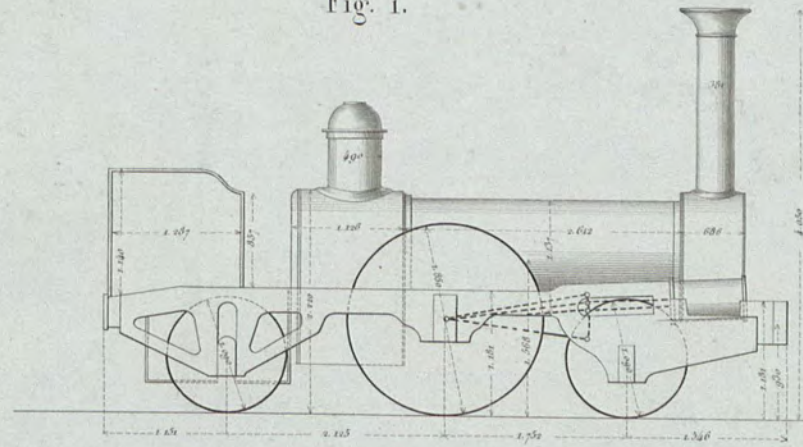

Fig. 2.

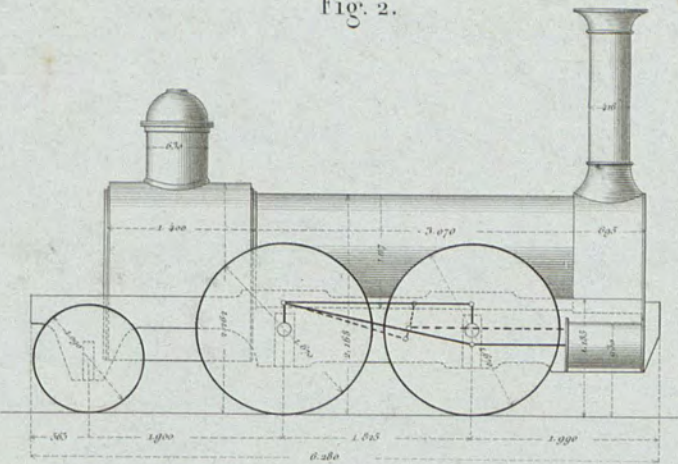

Fig. 3.

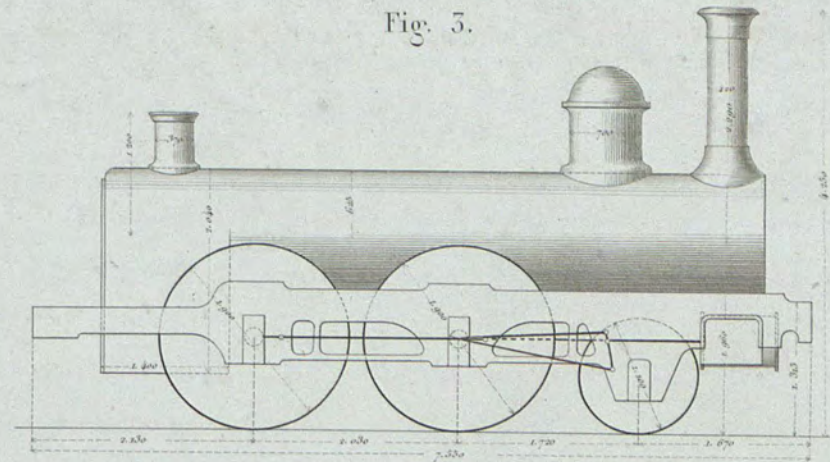

Fig. 1'

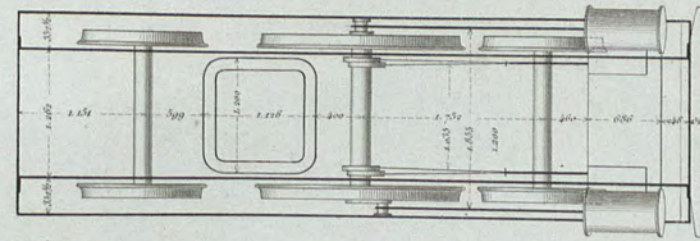

Fig. 2'

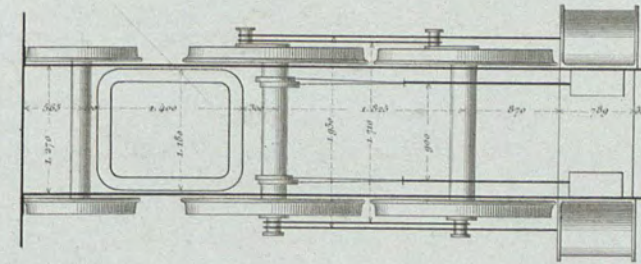

Fig. 3'

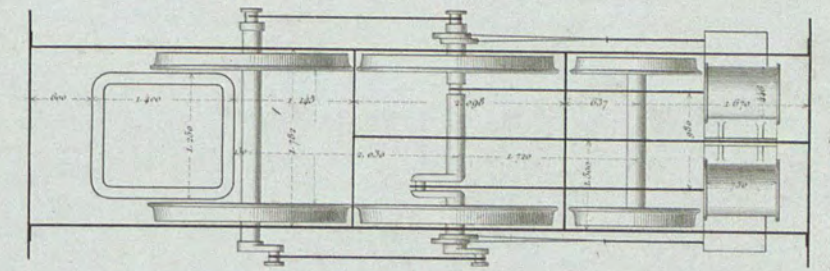

Fig. 4.

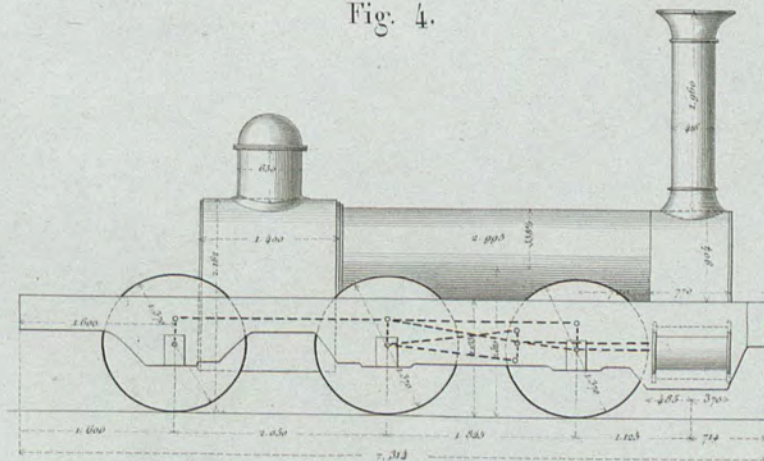

Fig. 5.

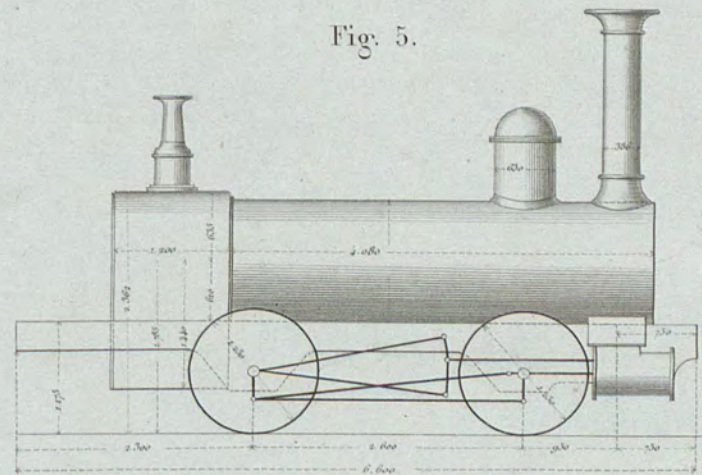

Fig. 6.

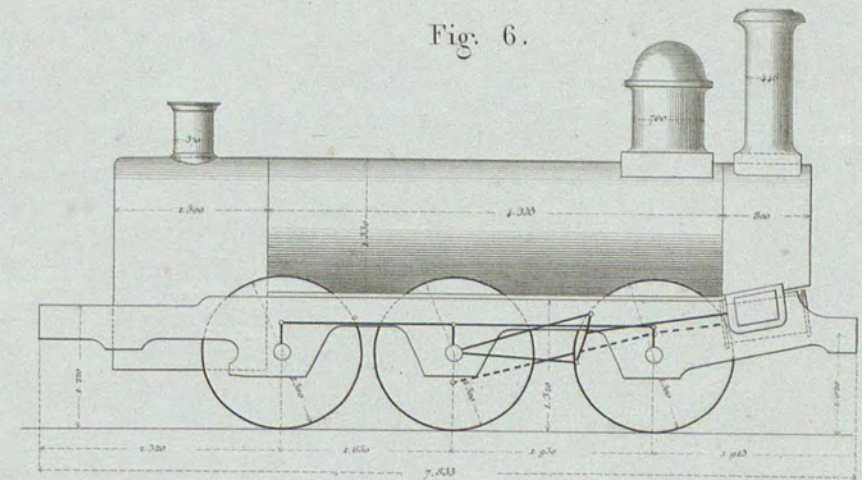

Fig. 4'

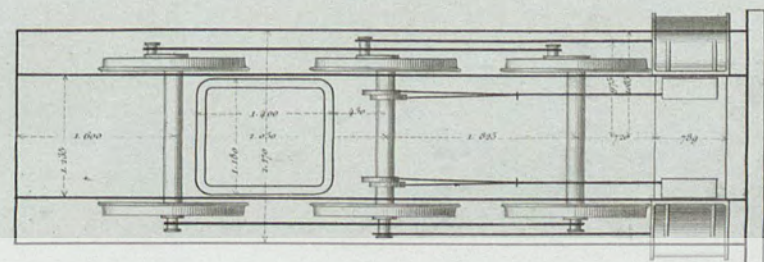

Fig. 5'

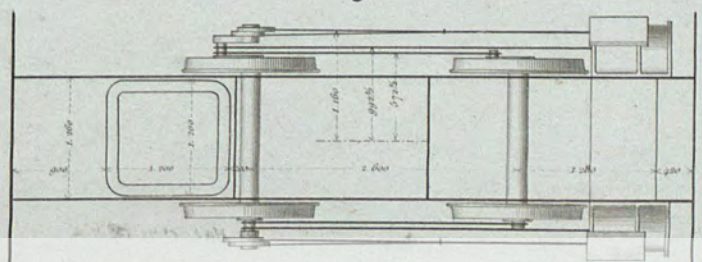
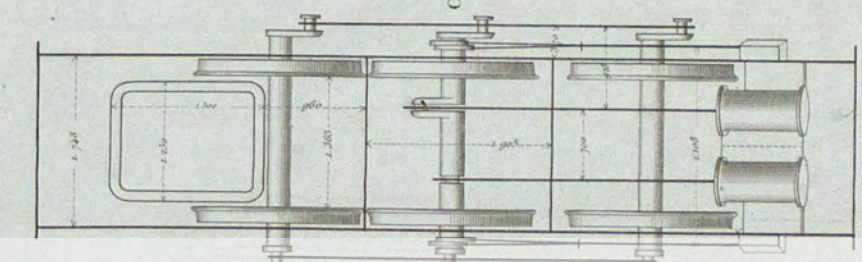
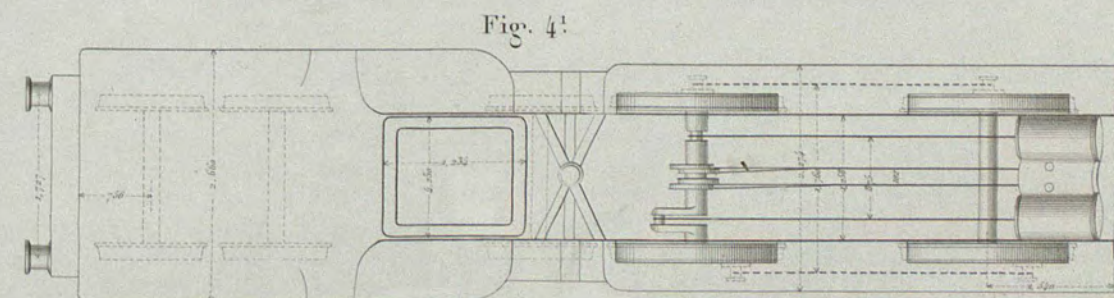
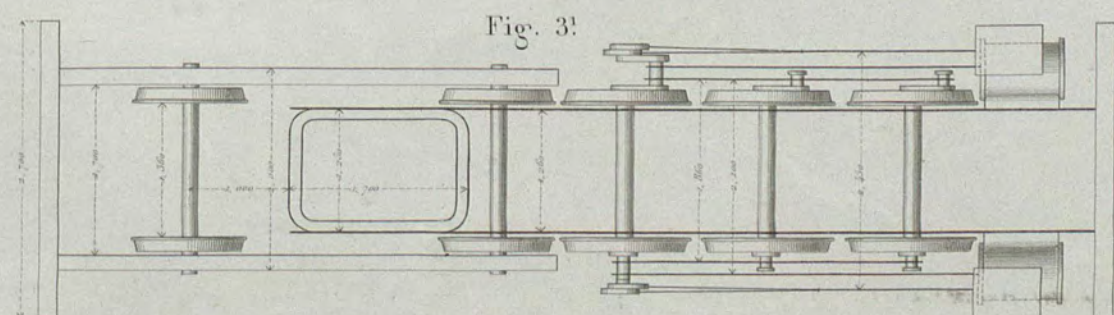
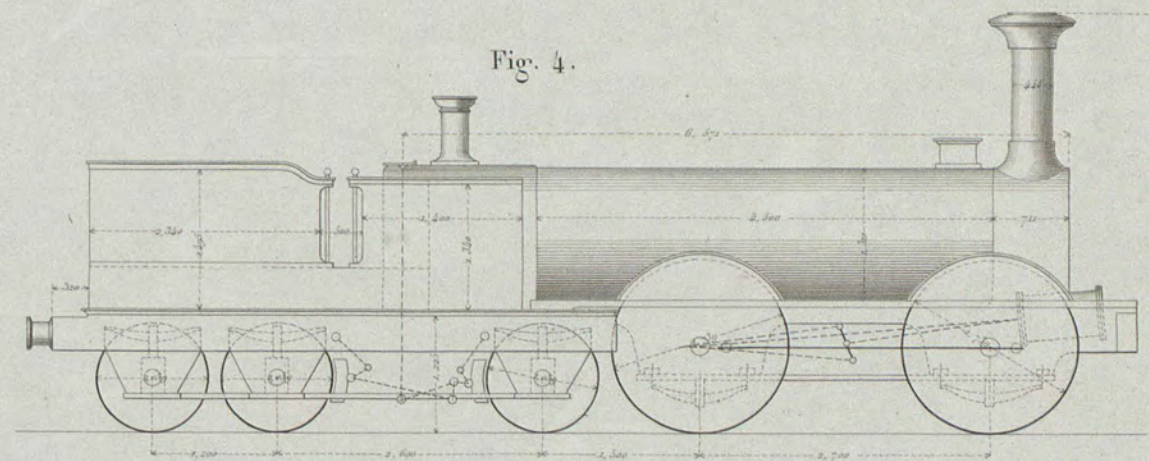
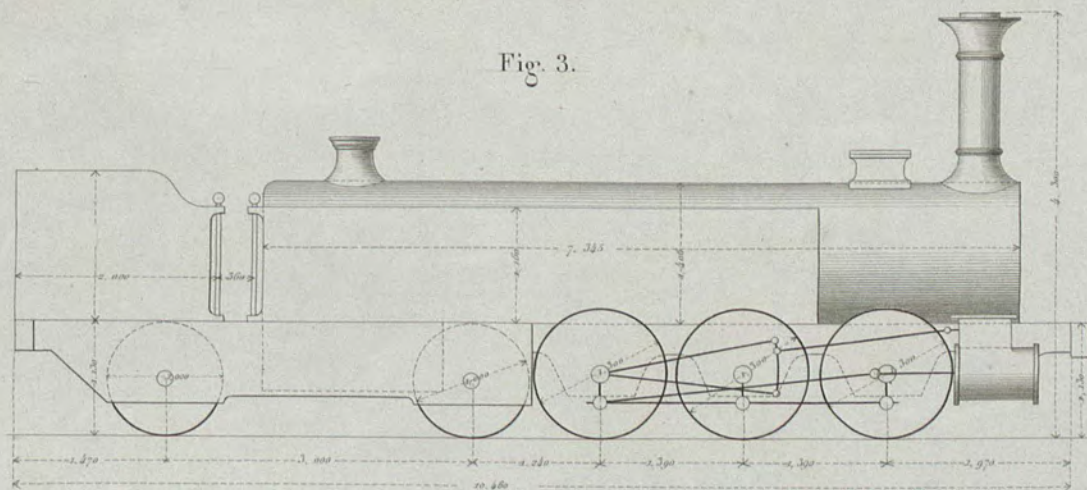
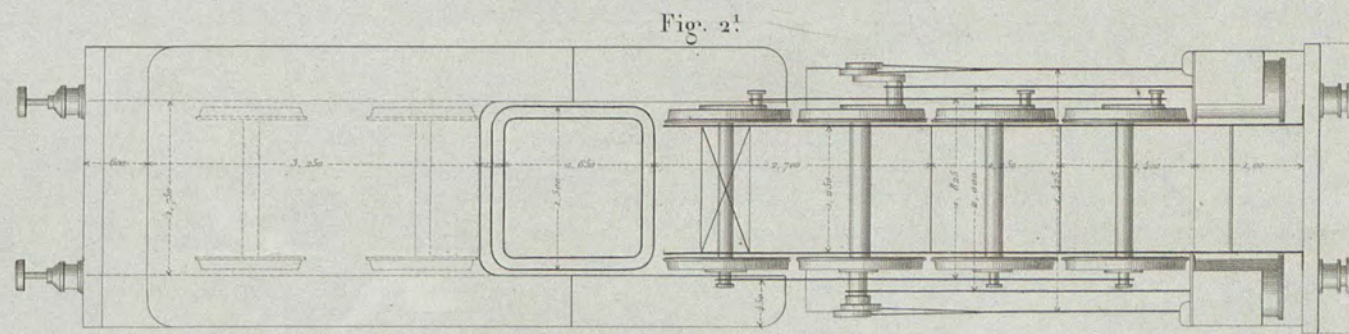
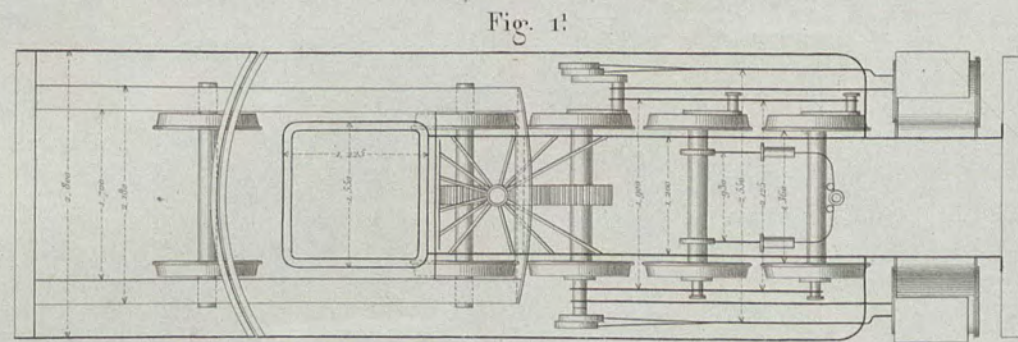
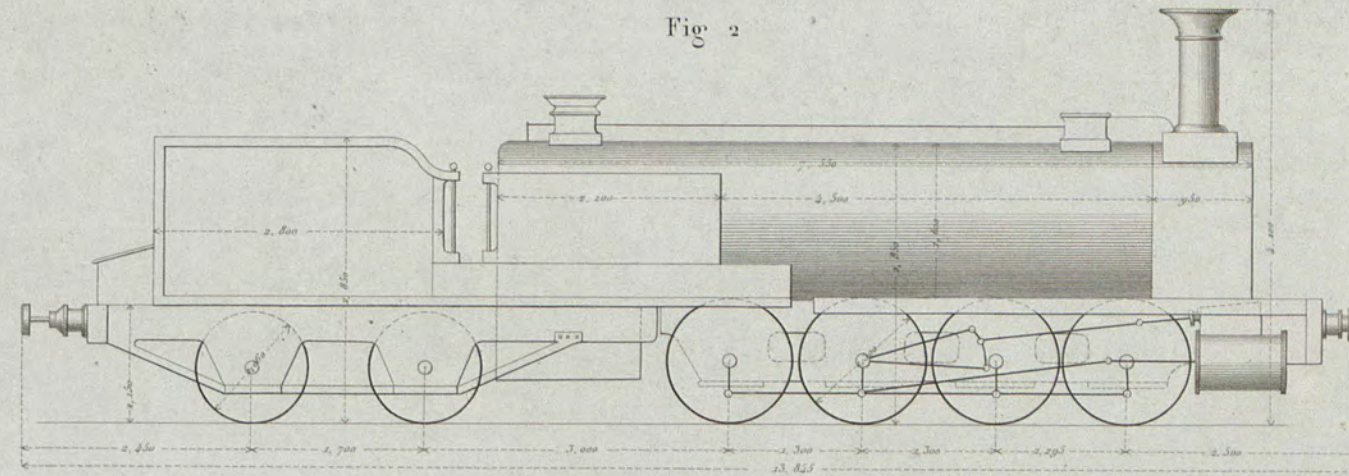
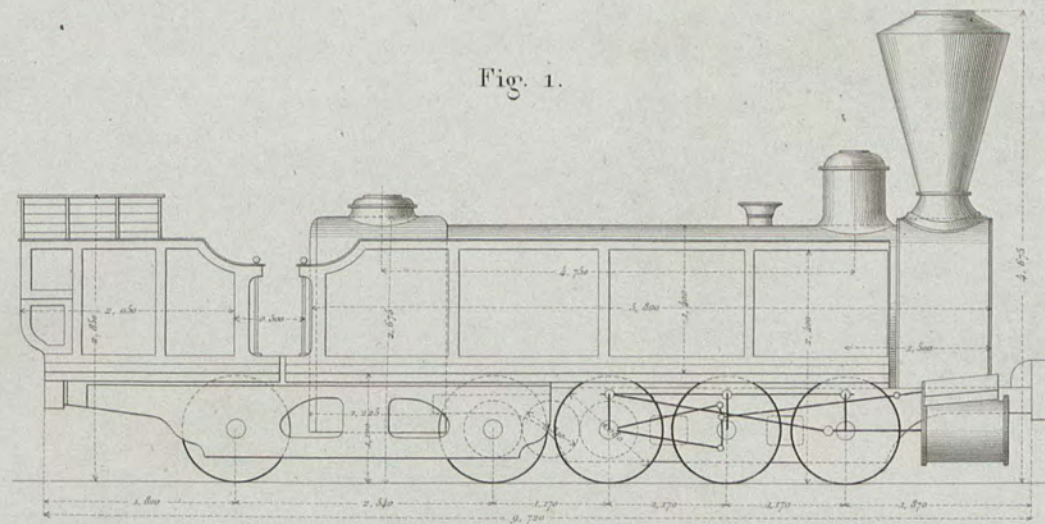

Fig. 6'



Echelle 1/5





Echelle 1/50

Fig. 1.

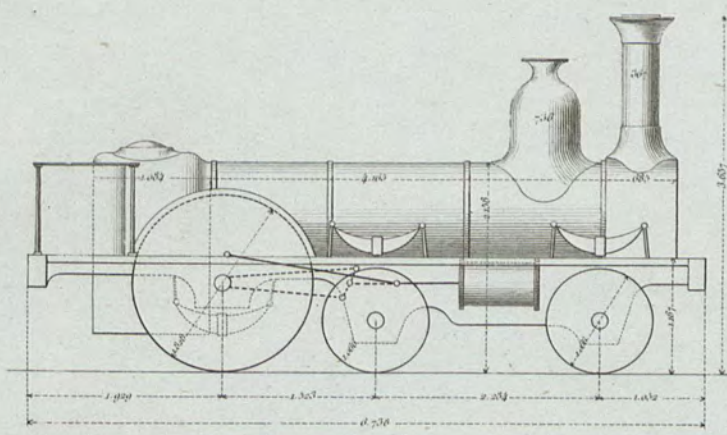

Fig. 3.

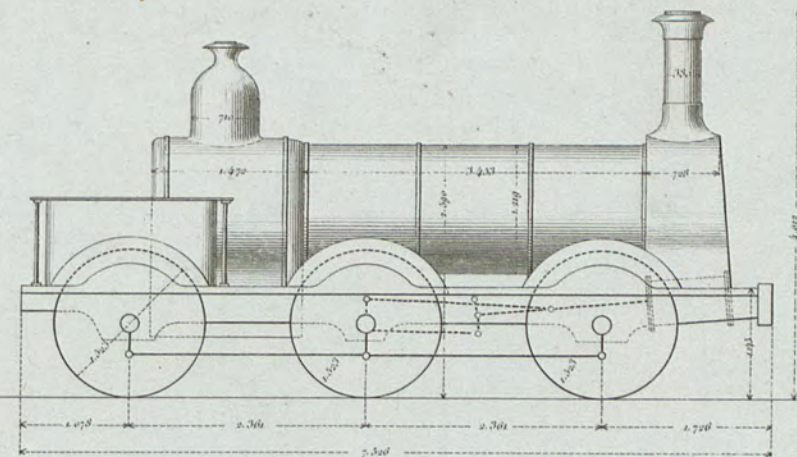

Fig. 5.

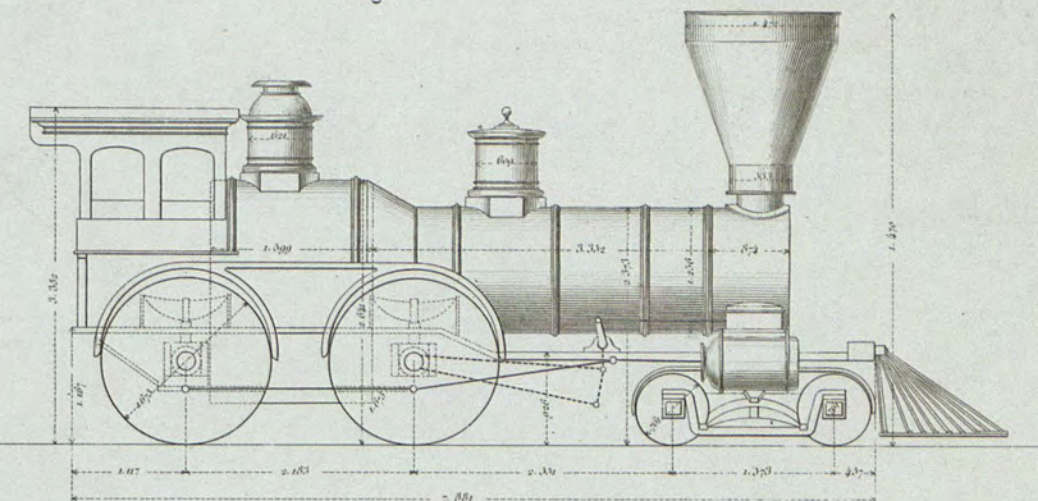

Fig. 1.'

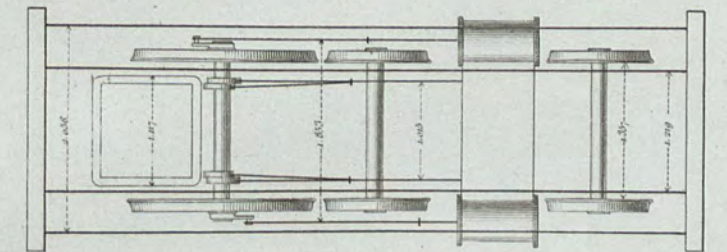

Fig. 3.'

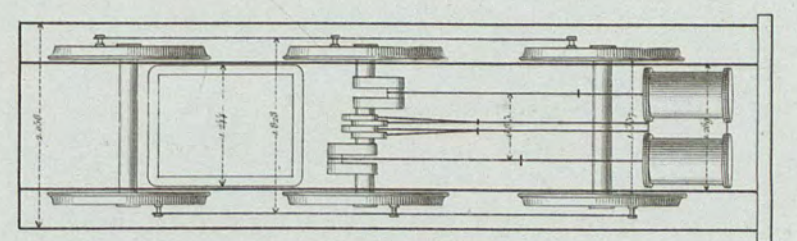

Fig. 5.'

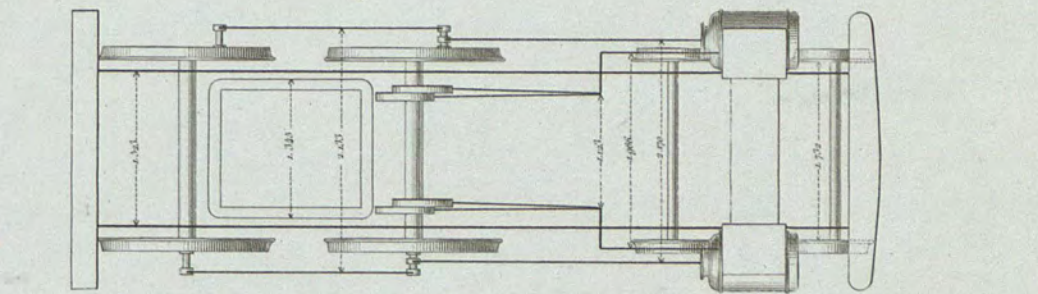

Fig. 2.

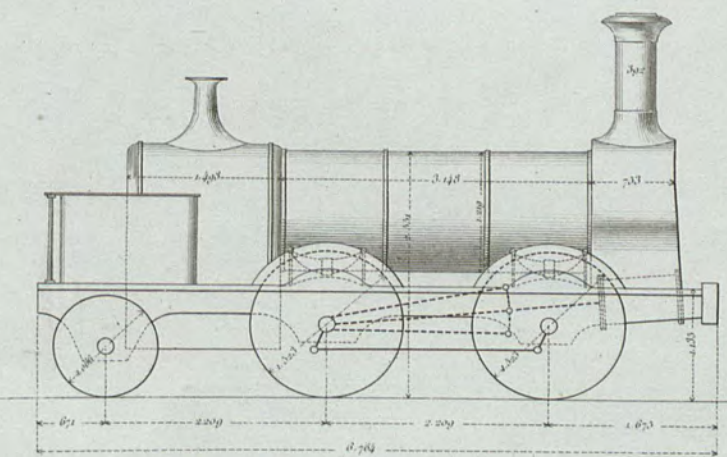

Fig. 4.

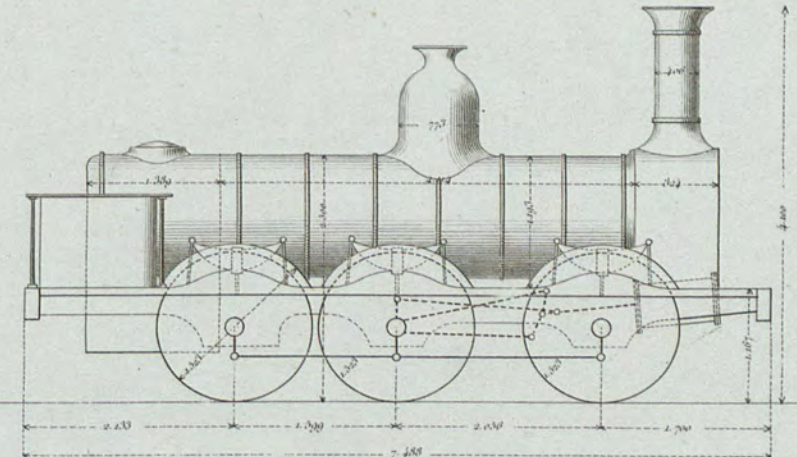

Fig. 6.

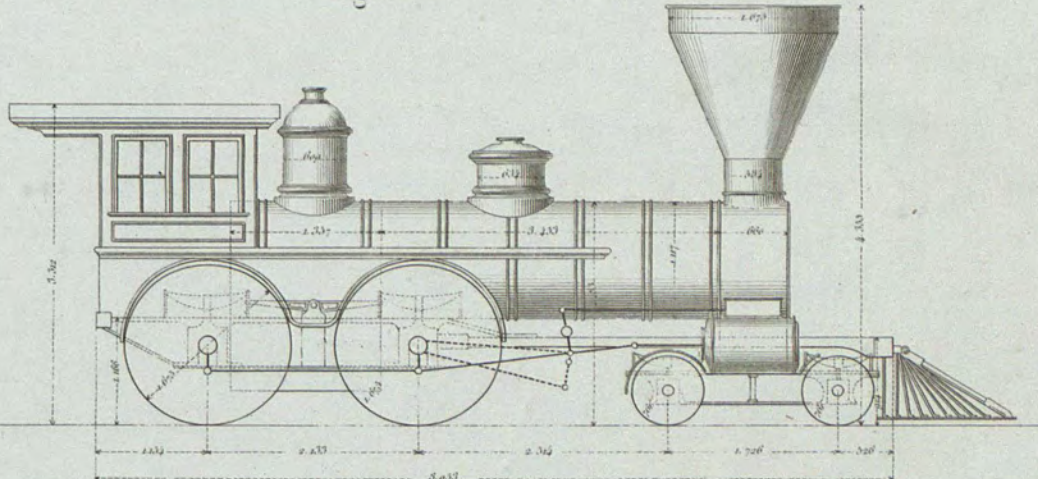

Fig. 2.'

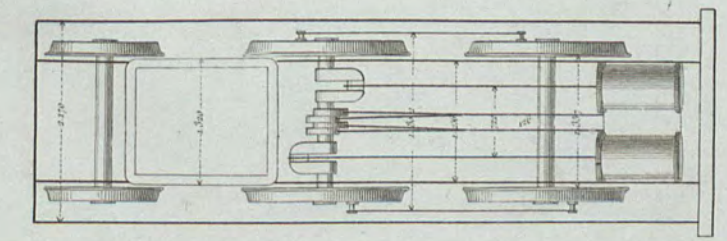

Fig. 4.'

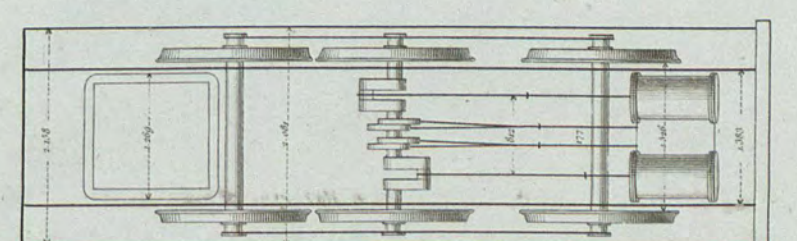

Fig. 6.'

