

ZYGMUNT DZIECHCIOWSKI, ANDRZEJ CZERWIŃSKI*

NOISE ANALYSIS OF THE LONGITUDINAL PAPER CUTTING MACHINE IN THE CONTEXT OF DECLARATION OF COMPLIANCE OF THE MACHINERY

ANALIZA HAŁASU MASZYNY DO WZDŁUŻNEGO CIĘCIA PAPIERU W KONTEKŚCIE DEKLARACJI ZGODNOŚCI MASZYNOWEJ

Abstract

The paper summarises the noise measurements of a bobbin cutting machine, also referred to as a longitudinal paper cutter machine, taken as a part of the procedure involved in the declaration of compliance of the machinery. Noise measurements were taken with a view to improve the conditions in the work environment. Due to the machine operation, noise level conditions were determined by testing the impulse response inside the machine room. Calculations were carried out in an attempt to improve the working conditions for machine operators.

Keywords: noise analysis, declaration of compliance of machinery, acoustic adjustment

Streszczenie

W artykule przedstawiono wyniki pomiarów i analiz bobiniarki, tj. maszyny do wzdłużnego cięcia roli papieru. Pomiarów te były częścią prac związanych ze spełnieniem przez badaną maszynę wymagań deklaracji zgodności maszynowej. W ramach pracy wykonano pomiary hałasu i analizy, których celem była poprawa warunków pracy na stanowisku pracy poddanym ocenie. W ramach pomiarów przeprowadzono tak ocenę warunków akustycznych wywołanych pracą maszyny jak i określono odpowiedź impulsową pomieszczenia, w którym maszyna się znajduje. Wykonano również obliczenia w aspekcie poprawy warunków pracy.

Słowa kluczowe: analiza hałasu, deklaracja zgodności maszynowej, adaptacja akustyczna

DOI:

* DSc. Eng. Zygmunt Dziechciowski, DSc. Eng. Andrzej Czerwiński, Institute of Machine Design, Faculty of Mechanical Engineering, Cracow University of Technology.

1. Introduction

In the context of EU regulations aimed to ensure work safety for machine operators, it is required that all machines designed, manufactured, launched and put to use should ensure the highest possible safety levels. Employers are obligated to ensure that machines are used for what they are intended, in accordance with the manufacturer's recommendations and that all further steps and measures are taken when necessary to improve safety features [1]. This approach is pursued in two basic groups of EU directives on work safety. The first group of documents are those having relevance to design, manufacturing, launching and use of machines and other products, issued to ensure the best safety levels possible. Among those documents, the Directive on Machinery is now of key importance [2]. The other group of EU directives are those specifying the minimum requirements that need to be satisfied when arranging the operators' work and the work environment, such as [3, 4, 5].

The respective requirements as to health and safety and work are applicable as long as the machine operated in the manner specified by the manufacturer still poses a real occupational hazard addressed by the relevant standard requirements, including those relating to noise and mechanical vibration control.

The group of machines covered by the Directive on Machinery [2] includes machines used in the paper industry and the printing industry, for example bobbin cutting machines, which produce high-level acoustic emission when in service. This is caused by the structural design of the machine and its interactions with additional equipment, which are necessary for the process.

As mentioned above, the technological process used in the paper industry and the printing industry makes that they are characterised by the production of high-level acoustic emission when in service. Because of this, they should often be subjected to acoustical adaptation. This adaptation should be preceded by computer simulations. The articles [6] [7, 8, 9] concern the issues of improving the acoustical conditions in the workplace inside of a printing house. In these articles are described, inter alia, the identification process of noise sources, the measurement methodology of acoustic properties of a room (production hall), as well as the results of digital simulation for the selected configuration of acoustic protections.

The purpose of the present study was to determine the potentials of noise reduction in areas in the vicinity of paper cutting machines such that the requirements set forth in the Directive on Machinery should be complied with. Digital simulation procedures were performed to assess the potential benefits of applying a variety of noise reduction strategies (reducing the level of noise produced by machine components, improving the noise absorption capacity of the machine room). The parameters of the calculation model were determined based on sound level measurement data.

2. Test object

The test object was a bobbin cutting machine, i.e. a machine for longitudinal paper cutting. During the cutting process, the roll of paper is spread on the rewinding cylinders, rewound on the roller set and cut longitudinally with circular cutters, followed by winding

of the paper sheet. The machine is located in a room of 12 m in length, 5.7 in width and 3.27/2.88 in height, the ceiling in the room is sloping. The walls and the ceiling are plastered. Up to about 2 m in height, the walls are coated with enamel, and above that painted with an emulsion paint. The ceiling is painted with an emulsion paint, too. The floor is made of ground concrete. There are two windows in the room (approximately 1 m × 2 m in size) and two gates 2.75 m × 2.75 m. The gates are locked by a sliding door. The layout of the room is shown in Fig 1.

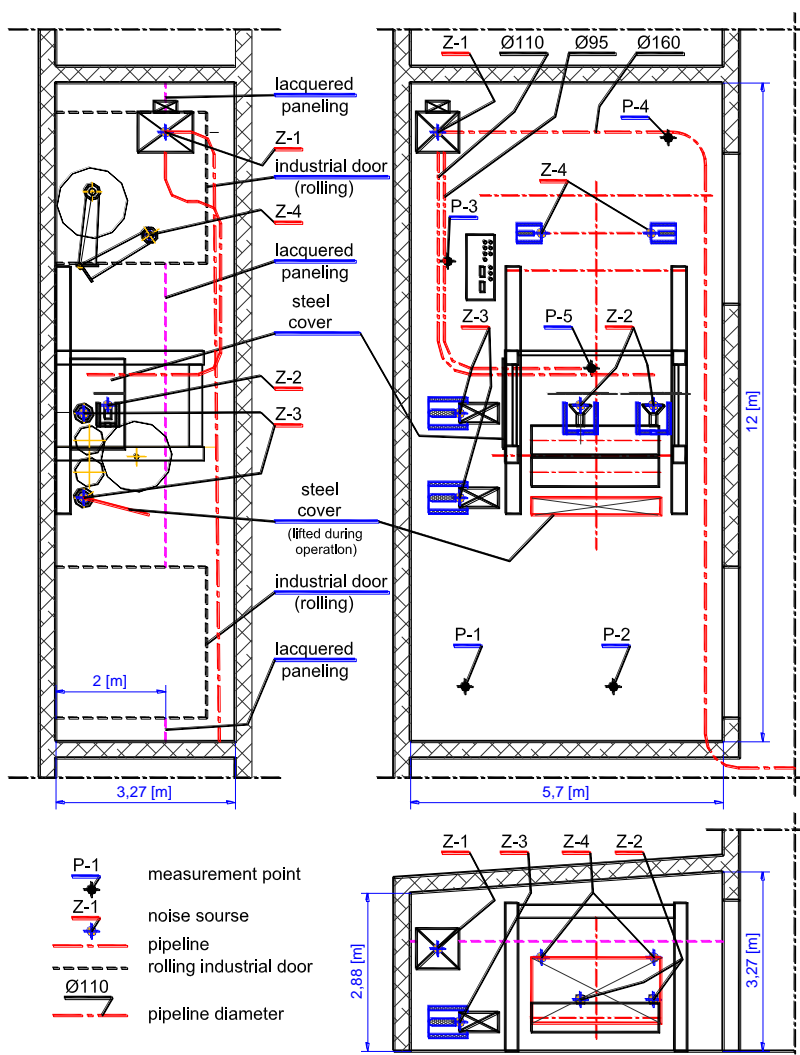

Fig. 1. Test object- position of the bobbin cutting machine inside the room

The bobbin cutting machine has two integral components: the machine for cutting paper sheets on the winding and rewinding end plus the cutting tools and the exhaust system (an exhaust fan with the pipeline, suction nozzles). Key machine components are shown in Fig 1.

Major sources of noise in the investigated area include:

- an exhaust fan (designated as Z-1 in Fig. 1),
- suction nozzles (designated as Z-2 in Fig. 1),
- unwinding cylinder drives (designated as Z-3 in Fig. 1),
- an unwinding roll drive (designated as Z-4 in Fig. 1).

3. The maintenance zone of the operator

When the bobbin cutting machine is in operation, machine operators spend most of their time in zones shown in Fig. 2 and listed in Table 1. During the analyses, attention should mainly be paid to these zones.

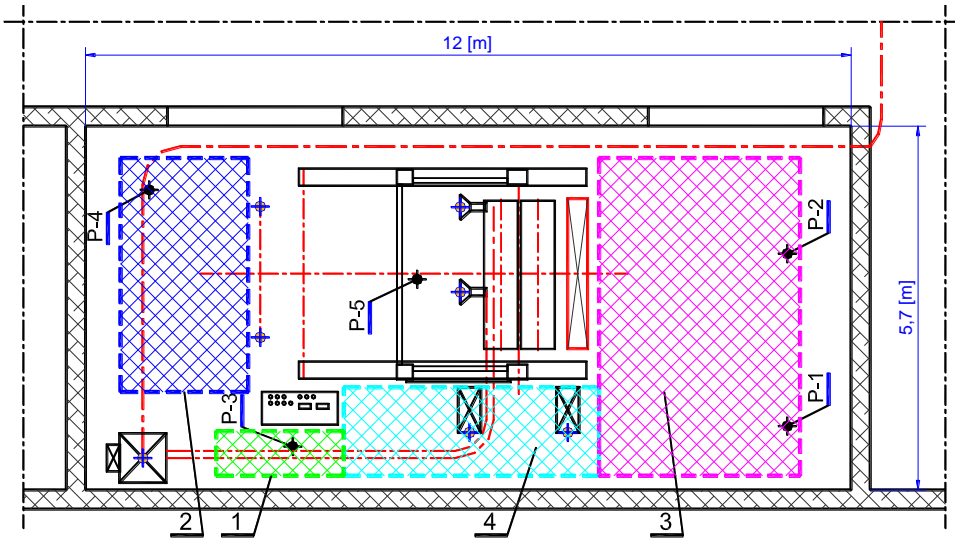

Fig. 2. Investigated area- the workplace operation zones

Table 1

Designation of workplace operation zones (see Fig. 1)

Name of zone	Number of area according to Fig. 2
The operating desktop zone	1
Loading the paper roll zone	2
Receiving the paper roll zone	3
The maintenance zone along the machine	4

4. Results of sound level measurements in workplace operation zones

Sound level measurements were taken to determine the noise levels in particular workplace operation zones (as shown in Fig. 2).

Results of measurements taken in the existing conditions are summarised in Table 2, revealing the exceeded values of equivalent noise levels in relation to the admissible levels during the 8 hours' noise exposure for humans ($L_{EX\ 8h\ perm} = 85\text{ dB}$ [10]). Measurements were taken in accordance with the procedure specified in [11, 12].

Table 2

Variability range of the equivalent noise levels in investigated zones- present conditions

Measurement area in accord. with Fig. 2 and Table 2	Mean value for the area $L_{Aeq\ meas\ av}$ [dB]	Exceeding the permissible noise level value for 8 hours' exposure ($L_{EX\ 8h\ perm} = 85\text{ dB}$) $L_{Aeq\ meas\ av} - L_{EX\ 8h\ perm}$ [dB]
[1]	[2]	[3]
1	85.3	0.3
2	87.0	2.0
3	87.1	2.1
4	87.0	2.0

5. Identification of noise sources

To identify the major noise sources inside the machine, sound analyses were performed for various modes of machine operation. Measurements were taken at five points, indicated in Fig 1 and in the vicinity of the selected sources. Specificity of machine operations and processes involved precluded separate measurements of each individual source. Therefore, measurements were repeated for as large as possible number of configurations of operating noise sources.

Table 3

Operating configurations- designations and description

Configuration number	Designation area in accord. with Fig. 3	Description of configuration area in accord. with Fig. 2
Config. No. 1	K-1	Machine stopped; working only source Z-4
Config. No. 2	K-2	Machine stopped; work only noise sources Z-1, Z-2, Z-4
Config. No. 3	K-3	Machine is running; work of sources Z-3, Z-4; without of noise source Z-1, Z-2
Config. No. 4	K-4	Machine is running; work of sources Z-1, Z-3, Z-4; without of noise source Z-2
Config. No. 5	K-5	Machine is running (full operating); work of sources Z-1, Z-2, Z-3, Z-4
Config. No. 6	K-6	Machine stopped; the background noise

Results of 1/3 octave band analysis of the noise levels as given in Fig. 3 as averaged values from 5 measurement points. Plots represent particular configurations of contributing noise sources (summarised in Table 3). Fig. 3 also plots the background noise curve (K-6 curve) and the K-5 curve obtained for all noise sources working, including the cutting process). In Fig. 3 are placed also the summated values of noise level A for the entire frequency band. These values are given in frames where the frame colour and edge pattern correspond to relevant plots.

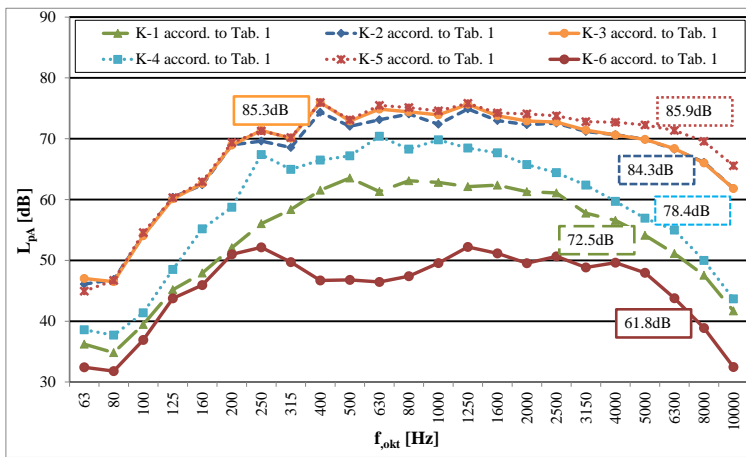

Fig. 3. 1/3 octave band analysis of sound level for the given configuration of operating noise sources – averaged values from 3 measurement points

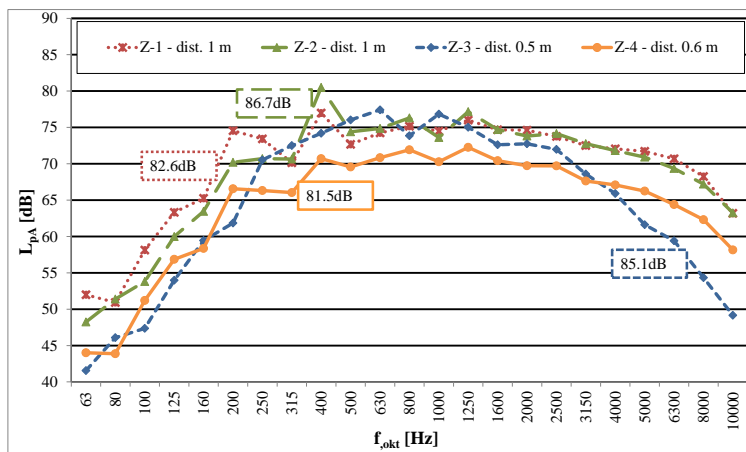

Fig.4. 1/3 octave band analysis of sounds from individual noise sources (Z-1, Z-2, Z-3, Z-4) – near-field measurements

For selected sources, measurements of sound levels were also taken in their close vicinity. Measurement data are summarised in Fig. 4, listing the source number and the distance at which the measurement was taken.

Basing on noise level measurements at selected points near the machine and for various configurations of noise sources, the numerical simulation procedure was applied to identify the sources and establish their sound power levels. To account for sounds reflected in the room, the reverberation time was measured, in accordance with the procedure set forth in [13].

The reverberation time measurement process was also described in [9]. In the room in question, the reverberation time was determined on the basis of the measurement of impulse responses in several points located at a height of 1.2 m above the floor on its overall area. To perform the measurements, measuring equipment shown in Fig. 5 was employed.

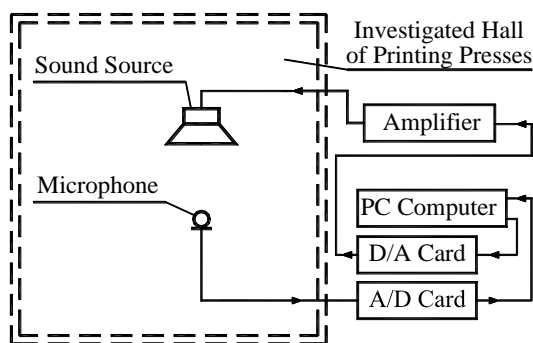

Fig. 5. Measuring equipment

Measured reverberation times are summarised in Fig. 6.

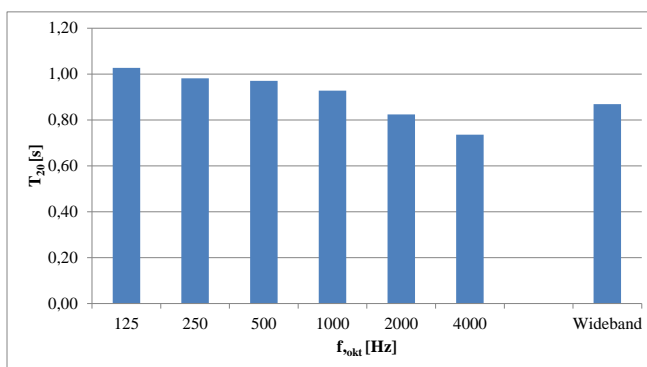

Fig. 6. Values of reverberation time inside the room

Finally, estimated values of sound power level L_{WA} of particular noise sources are summarised in Table 4. The sound power level L_{WA} values were estimated in accordance with the procedure given in [14].

Table 4

Estimated values of sound level L_{WA} from the noise sources

The noise source	Designation in Fig. 1	The number of noise sources	Sound power level L_{WA} [dB]
Exhaust fan	Z-1	1	90
Suction nozzles of paper scrap	Z-2	2	89
Drive of a unwinding cylinders	Z-3	2	86
Drive of a roll unwinding	Z-4	2	79
Pipeline (as a total one)	–	–	71

6. The effects of acoustic adjustments and control on noise distribution in the workplace operation zone

The analysis was conducted to determine the effects of specific sound control and adjustment solutions on the noise levels in the workplace operation zones.

The calculation procedure was applied addressing three aspects: first - adjustments of noise sources, designated with “I”, second – acoustic design and adaptation of the room’s interior, designated with “II” and third – improvement of working conditions at the control desk, designated with “III”. As regards the adjustments of noise sources, several solutions were considered that were aimed at reducing noise emissions to acceptable levels (four options were considered, indicated by numbers 1÷4). In the calculation procedure associated with potential modifications of the machine room, two solutions were considered (II.1, II.2). Further combinations of measures taken to reduce the sound levels were considered too (enhancing the sound absorption capacity of the room and providing a screen near the control desk- designated as “I.4+II.2”), thus yielding 8 options to be handled in calculations.

These options are summarised in Table 5.

Options (I) (designated with “I” in the calculation procedure) involve the modification or adjustments of noise sources, such as fans or driving systems. Four combinations of noise sources were considered (I.1 to I.4), listed in Table 6.

Further calculations were performed to find out how the improvement of sound absorption capacity of the machine room should affect the noise levels. It is suggested that sound absorption capacity of one wall (the wall near the exhaust fan) and of the ceiling should be improved. Average values of the sound absorption coefficients for the walls and the ceiling in the room in the present conditions are taken to be $\alpha = 0.13$ (walls) and $\alpha = 0.11$ (ceiling). The sound absorption coefficient of the used sound absorbent material is $\alpha = 0.5$ [15].

Table 5

Configurations of noise control measures in the considered variants

		Noise control measures						
		Acoustic adjustments of the noise sources in the machine				Acoustic design and adaptation of the machine room		Modification of the control desk
		Exhaust fan Z-1	Suction nozzles of paper scrap Z-2	Drive of a unwinding cylinders Z-3	Drive of a roll unwinding Z-4	Ceiling	Back wall	Screen of a desktop
Designation	[1]	[2]	[3]	[4]	[5]	[6]	[7]	
Variant of calculations	I.1	x	x					
	I.2	x	x		x			
	I.3	x	x	x				
	I.4	x	x	x	x			
	II.1					x		
	II.2					x	x	
	I.4+II.2	x	x	x	x	x	x	
	I.4+III	x	x	x	x			x

Table 6

Solution options involving adjustment/ no adjustment of selected noise sources

Noise sources	Designation in Fig. 1	Characteristics of the calculation variants			
		I.1	I.2	I.3	I.4
Exhaust fan	Z-1	acoustical adaptation (9 dB) $L_{WA} = 81$ dB	acoustical adaptation (9 dB) $L_{WA} = 81$ dB	acoustical adaptation (9 dB) $L_{WA} = 81$ dB	acoustical adaptation (9 dB) $L_{WA} = 81$ dB
Suction nozzles of paper scrap	Z-2	a partial acoustic enclosure – absorber $R = 15$ dB	a partial acoustic enclosure – absorber $R = 15$ dB	a partial acoustic enclosure – absorber $R = 15$ dB	a partial acoustic enclosure – absorber $R = 15$ dB
Drive of a unwinding cylinders	Z-3	Without adaptation $L_{WA} = 86$ dB	Without adaptation $L_{WA} = 86$ dB	acoustical adaptation (5 dB) $L_{WA} = 81$ dB	acoustical adaptation (5 dB) $L_{WA} = 81$ dB
Drive of a roll unwinding	Z-4	Without adaptation $L_{WA} = 79$ dB	acoustical adaptation (5 dB) $L_{WA} = 74$ dB	Without adaptation $L_{WA} = 79$ dB	acoustical adaptation (5 dB) $L_{WA} = 74$ dB

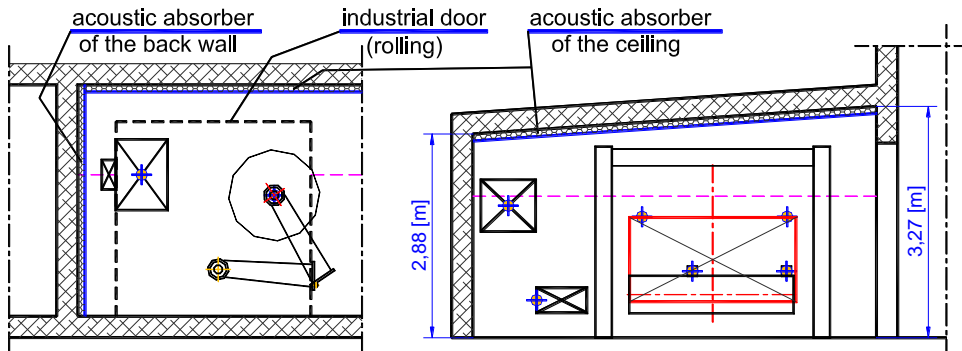

Fig. 7. Positions of acoustical absorbers on the back wall and on the ceiling

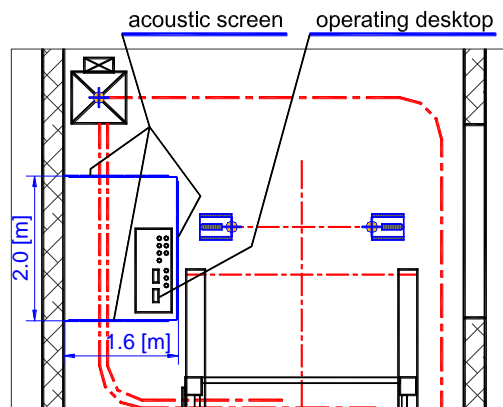

Fig. 8. Position of an acoustic screen protecting the control desk

Surfaces subjected to acoustical adaptation are shown in Fig. 7.

Calculations were also performed to account for the case when a screen was provided to protect the operator from acoustic wave emissions when monitoring the machine. The acoustic screen shall be made of PVC baffles, its position with respect to the control desk is shown in Fig. 8.

Other solutions considered in the procedure were combinations of several sound control measures. Calculations were performed to determine the effectiveness of these sound control measures in relation to particular noise sources (i.e. variant I.4 in Table 3) and to establish the effectiveness of the two sound absorbers (variant II.2 in Table 3). This variant is designated as “I.4+II.2” in Table 3. The effects of acoustic adjustment of all sources and providing the protective screen near the control desk are estimated in the solution variant labelled as “I.4+III”.

7. Calculation results

Measurement data were utilised in computer simulations to investigate both the existing conditions and the 8 variants listed in section 6. Calculation data are presented in the form of sound level distribution maps.

Fig. 9 plots the results obtained in the present conditions. Figs. 10 and 11 show the sound pressure distribution maps for selected variants of room adaptations, illustrating the effectiveness of noise control measures involved in particular solutions.

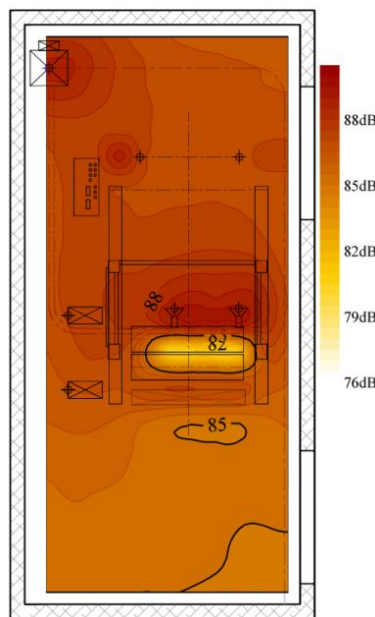

Fig. 9. Sound pressure level distribution inside the room- present state

Analysis of a map in Fig. 9 reveals that among the workplace operation areas, the highest noise levels are registered in the vicinity of sources Z-1 and Z-2, and near the control desk. The sound level registered in these zone approaches 87÷86 dB. Near the point where the paper roll is set, the sound level is as high as 85 dB.

Fig. 10 plots the results obtained when the acoustic adjustments and modifications are made to control the noise level near the major sources (variant I.4). Fig. 10a shows a map of noise distribution around the bobbin cutting machine and the effects of using the noise control measures listed in Fig. 6 are illustrated in Fig. 10b. It is readily apparent that adjustment measures provided in variant I.4 lead to a reduction of sound pressure by 4 or 5 dB.

Noise reduction is more significant when sound absorbers are placed on the wall (variant II.2), which is shown in the map in Fig. 10c. The map plotting the sound pressure reduction levels (Fig. 10d) reveals that in the workplace operation zone, the noise reduction effect is less significant than in the variant I.4 (by 1 or 2 dB).

The effects of simultaneous adjustments and modifications near the major noise sources (I.4) and adaptation and acoustic re-design of selected walls (II.2) are illustrated in Fig. 10a and 10b. In the operation zones the noise level may be reduced by 8÷9 dB.

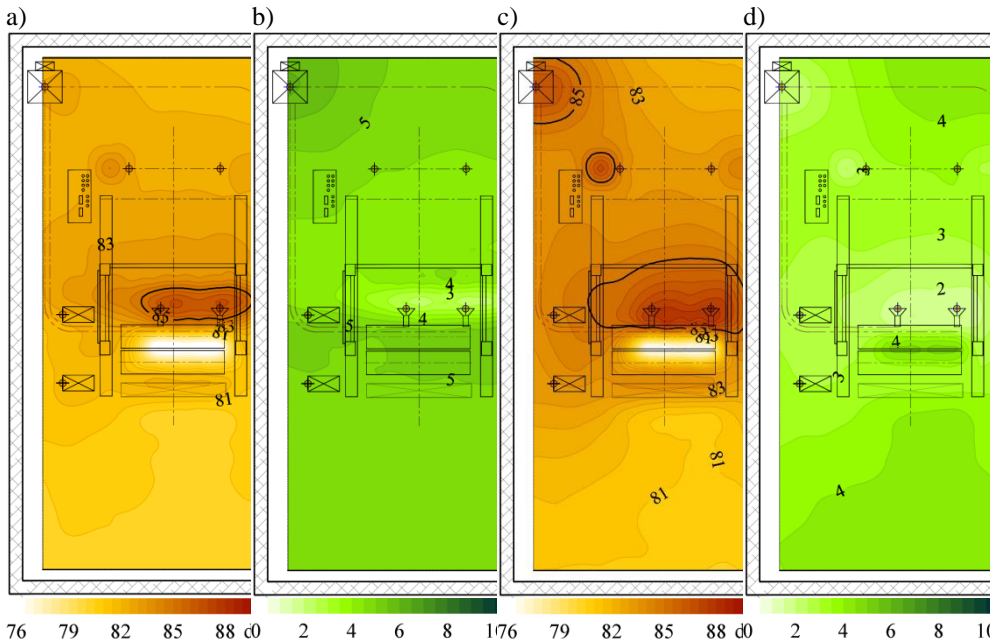

Fig. 10. Calculation results: a) sound pressure level for variant I.4; b) noise reduction for variant I.4; c) sound pressure level for variant II.2; d) noise reduction in variant II.2

Figs. 11a and 11c plot the calculation data obtained for the specific case when the major noise sources were controlled (I.4) and, at the same time, a screen was provided to isolate the control desk zone (III). Noise reduction by 5÷7 dB is sufficient to ensure that the noise levels experienced by the machine operator should be reduced to acceptable levels in the work environment. Distribution of noise reduction values inside the room is presented in Figs. 11c and 11d.

The analysis of results allows for evaluating the potential noise reduction strategies to be implemented in the operation zones (Fig. 2), enabling a preliminary cost analysis of such solutions.

Application of the protective measures listed in variants I.4 (see Table 6), involving the adaptation of the major noise sources and the fan. Providing a transparent screen made of PVC (variant “I.4+III”) leads to further noise reduction in the zone I (see Fig. 2).

In order that the noise levels in the workshop operation zones should fall within the admissible limits, it is required that additional flat sound absorbers should be installed on selected walls and on the ceiling (variant “I.4+II.2”). One has to bear in mind, however, that the costs of additional absorbers will be rather high.

Table 7 summarises the estimated noise reduction levels in the zones 1, 2, 3, 4 (see Fig. 2), for the specific solution variants.

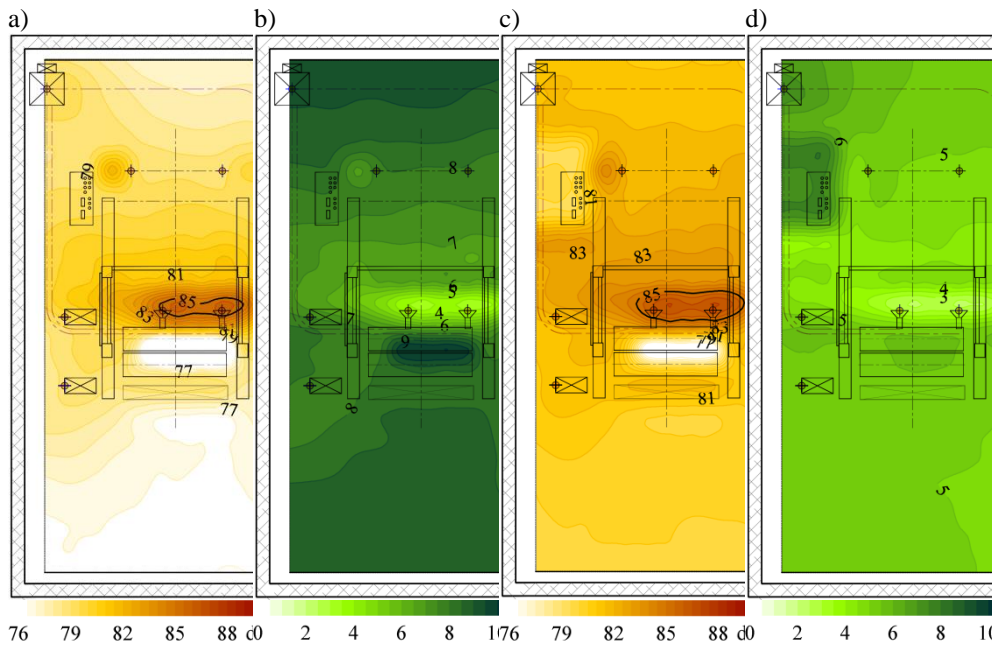

Fig. 11. Calculation results: a) sound pressure level for variant “I.4+II.2”; b) noise reduction for variant “I.4+II.2”; c) sound pressure level for variant “I.4+III”; d) noise reduction in variant “I.4+III”

Table 7

Predicted noise reduction in the workshop operation zone for analysed solutions in relation to the average measured sound level $L_{Aeq\ meas\ av}$ in the area

Zone number area in accord. with Fig. 2	Current state Average measured sound level $L_{Aeq\ meas\ av}$ [dB]	Predicted noise reduction in the workshop operation zone for analysed solutions in relation to the average measured sound level $L_{Aeq\ meas\ av}$ in the area $\Delta L_{red\ av}$ [dB] = $L_{Aeq\ meas\ av} - L_{Aeq\ zone\ av}$							
		I.1	I.2	I.3	I.4	II.1	II.2	I.4+II.2	I.4+III
[1]	[2]	[3]	[4]	[5]	[6]	[7]	[8]	[9]	[10]
1	85.3	2.6	2.8	4.4	4.7	3.3	3.9	8.5	5.1
2	87.0	2.4	2.6	4.2	4.5	2.3	2.9	7.2	4.8
3	87.1	3.1	3.4	4.4	4.8	2.4	3.2	8.2	7.4
4	87.0	3.2	3.7	4.2	4.8	2.6	3.5	8.5	5.4

8. Conclusions

The purpose of the present study was to estimate the effectiveness of the proposed modifications and acoustic adjustments aimed to reduce the noise level in the bobbin machine operation zone. The investigations were undertaken as part of the project aimed to ensure that all relevant requirements set forth in the Directive on Machinery should be complied with [2]. The study considers all potential noise control measures: modification and acoustic adjustment of machine components, re-design and adaptation of the acoustic features of the machine room and providing a transparent screen, made of PVC, around the control desk. Various configurations of sound control measures were duly evaluated. The list of applied noise control measures is given in section 6 and specific options (8) are summarised in Table 5.

The analysis identified the solutions that proved most effective.

The most effective noise reduction in operation zones was registered for the variants "I.4+II.2" and "I.4+III", which involve full adjustment of the noise sources and adaptation (increase the sound absorption coefficient) of the walls and ceiling in the machine room, as well as full acoustic adjustment of major sources of noise plus the screen provided around the control desk. Acoustical adaptation (increase the sound absorption coefficient) of walls and ceiling in the machine rooms with the use of sound absorbers is an expensive solution and found not to be cost-effective despite its excellent performance.

The effectiveness of variant I.4 in noise control is high, too. Even though not in all workshop operation zones could the noise levels be reduced to the admissible levels specified in normative references (below 85 dB), the effectiveness of noise control was found to be satisfactory. This view is fully justified since the normative value involves not only the actual noise level in the zone, but to exposure time as well.

Investigations show that in certain cases the requirements set forth in the Directive on Machinery [2] cannot be fully met through acoustic adjustments of the machine itself (or its components). In many cases, the machine and the machine room have to be treated as one system. Acoustic adjustments of machine components alongside the improvement of acoustic parameters of the machine room will lead to required results. One has to bear in mind the cost-effectiveness of the proposed solutions, which in many cases becomes the major criterion in decision-making.

References

- [1] *Ensuring compliance of machinery with the essential requirements in the field of health and safety. Guidelines for producers, suppliers and users of machinery* (in Polish), Centralny Instytut Ochrony Pracy – Państwowy Instytut Badawczy, www.ciop.pl, Warszawa 2010.
- [2] Directive 2006/42/EC of the European Parliament and of the Council of 17 May 2006 on machinery.
- [3] Directive 89/391/EEC – COUNCIL DIRECTIVE of 12 June 1989 on the *introduction of measures to encourage improvements in the safety and health of workers at work*.

- [4] Directive 2009/104/EC – use of work equipment of 16 September 2009 concerning *the minimum safety and health requirements for the use of work equipment by workers at work* (second individual Directive within the meaning of Article 16(1) of Directive 89/391/EEC).
- [5] Directive 89/655/EEC - COUNCIL DIRECTIVE of 30 November 1989 concerning the minimum safety and health requirements for the use of work equipment by workers at work (second individual Directive within the meaning of Article 16 (1) of Directive 89/391/EEC).
- [6] Czerwiński A., Dziechciowski Z., Krawczyk J., *The concept of reduction of the sound level at workplaces in the printing industry* (in Polish), in: *Teoretyczne osnowy eniergoriesursosbieriegajuscich priocesow, oborudowania i ekologičieski biezopasnych proizbodctw*, ISBN 978-5-9616-0377-4, Goubno ИГХТУ (IGChTU), Iwanowo – Rosja, 2010.
- [7] Borkowska-Czarnecka K., Czerwiński A., Dziechciowski Z., *Analysis of influence of new printing press installation on a acoustic climate in a press room of a printing house* (in Polish), *Czasopismo Techniczne „Mechanika”*, vol. 2-M, 2012, 55-62.
- [8] Czerwiński A., Dziechciowski Z., *Acoustic parameters verification of enclosures of high-performance printing presses* (in Polish), *Czasopismo Techniczne „Mechanika”*, vol. 2-M, 2012, 63-72.
- [9] Dziechciowski Z.; Czerwiński A., *Concepts of noise reduction in workplace areas of roll unwinding operators of printing offset press*, *Meždunarodnaâ Naučno-Tehničkaâ Konferenciâ Problemy resurso- i energosberegauših tehnologij v promyšlennosti i APK (PRET-2014)*, monografiâ, Ivanovskij Gosudarstvennyj Himiko-Tehnologičeskij Universitet, tom 2, 2014, 100-113.
- [10] Regulation of the Minister of Labour and Social Policy of 6 June 2014 on Maximum Permissible Concentration and Intensity of Agents Harmful to Health in the Working Environment, *Journal of Laws of 2014*, item 817.
- [11] PN-94/N-01307, *Noise – Permissible values of noise in the workplace – Requirements relating to measurements*.
- [12] PN EN ISO 9612:2009, *Acoustics – Determination of Occupational Noise Exposure – Engineering Method*.
- [13] PN EN ISO 3382-2:2010, *Acoustics – Measurement of Room Acoustic Parameters, Part 2: Reverberation Time In Ordinary Rooms*.
- [14] PN-EN ISO 3746:2011, *Acoustics – Determination of sound power levels of noise sources using sound pressure – Survey method using an enveloping measurement surface over a reflecting plane*.
- [15] Engel Z., *Environmental Noise and Vibration Protection* (in Polish), PWN, Warszawa 1993.