

PHILIPPE DELPECH*, THOMAS THIIIS**

APPLICATIONS OF “SNOWIND” ENGINEERING – CLIMATIC WIND TUNNEL METHODS

ZASTOSOWANIA TECHNIKI „SNOWIND” – METODY BADAWCZE STOSOWANE W TUNELU KLIMATYCZNYM

Abstract

Transport and deviation of snow by wind induce many constraints on buildings, vehicles and industrial systems. A selection of questions from snow-wind engineering are presented in the paper. The experimental method that was undertaken to investigate these questions makes use of a large climatic wind tunnel, partly designed to address snow engineering problems at full scale: snow penetration in buildings, into ventilation systems of buildings and vehicles and snow or ice accretions on structures.

Keywords: snow engineering, atmospheric icing, environmental actions, wind tunnel

Streszczenie

Transport i przemieszczanie śniegu przez wiatr powodują wiele ograniczeń dotyczących budynków, pojazdów i systemów przemysłowych. W niniejszej pracy przedstawiono kilka problemów z zakresu inżynierii wiatrowo-śniegowej. W celu uzyskania na nie odpowiedzi użyto metod badawczych wykorzystujących duży tunel klimatyczny, zaprojektowany częściowo z przeznaczeniem do rozwiązywania zagadnień inżynierii śniegowej w skali naturalnej, np.: przedostawania się śniegu do budynków, systemów wentylacyjnych budynków i pojazdów oraz gromadzenia się śniegu lub lodu na konstrukcjach.

Słowa kluczowe: inżynieria śniegowa, oblodzenie atmosferyczne, oddziaływania środowiskowe, tunel aerodynamiczny

DOI: 10.4467/2353737XCT.15.145.4182

* Centre Scientifique et Technique du Bâtiment, Nantes, France.

** Department of Mathematical Sciences and Technology, Norwegian University of Life Sciences, Norway.

1. Introduction

Snow may interact in different ways with structures and can induce many problems in buildings and systems exposed to atmospheric conditions. Due to the multiform nature of snow, the deposition process and the mechanical and thermal properties of snow, it may induce many problems which, in some cases, may have tragic consequences.

The low density of snow flakes and the granular, solid form of the material (unlike rain) make it disposed for aeolian transport into open elements such as building ventilation openings. Depending on the system concerned, the consequences may be very detrimental to the proper use of the building and the safety of occupants; ventilation failure, damages to the insulation, local mechanical constraints, and potentially tragic if safety devices are affected.

Wet snowfall episodes produce localized snow accretions on all kind of surfaces (façade elements, inclined walls, solar shades, ...). These snow accretions with high cohesive forces induce constraints on structures as well as many mechanical systems in fields as diverse as transport, buildings, infrastructures, energy production and transports.

Beyond local mechanical constraints, which these types of snow accretions induce at the time of creation, the accidental risk is increased if the accumulations occur on high rise structures or fast moving vehicles and suddenly fall off due to temperature rise, vibrations of support, or wind effects.

These situations may require an experimental approach that allows control of the main climatic parameters such as air temperature, wind velocity and concentration of snow/ice particles, to reproduce the interaction phenomena as they are observed in nature. This possibility is offered by a large climatic wind tunnel where it is possible to reproduce the phenomena at scale 1:1. The thermal circuit of the Jules Verne climatic wind tunnel (Fig. 1), with artificial snow making capabilities, can reproduce various kinds of snowstorm events. Wind velocity, ambient air temperature and air/water ratio in the snow guns are fully controllable to determine the snow properties (dry or wet snow). The large dimension of the test chamber, 25 m long, 10 m wide and 7 m high, enables simulation of mechanisms of snow/building interaction at a full- or moderately reduced scale.

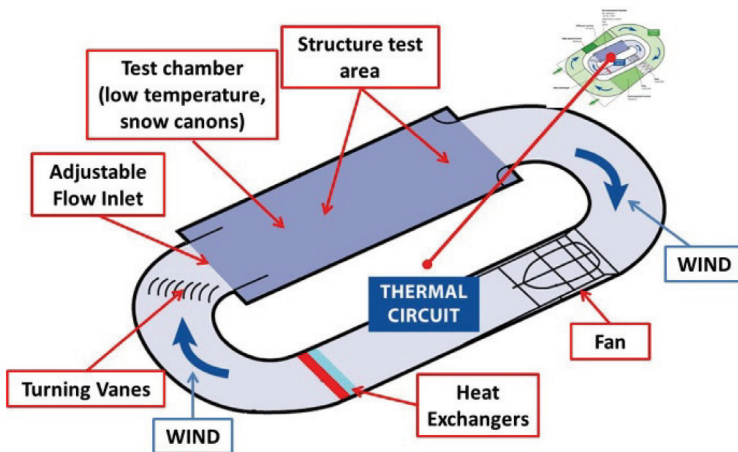

Fig. 1. The thermal circuit of the Jules Verne climatic wind tunnel

The appropriate thermodynamic conditions (air temperature and humidity) are controlled by two heat exchangers (cold and warm) across the section of the wind tunnel. Snow guns are fitted into the test section nozzle. They are used to generate a freezing water spray, which produces the snow cover. The typical grain flake diameters produced by the snow gun in the wind tunnel range from 0.150 to 0.450 mm.

The air temperature, and air/water ratio in the snow guns, can be set to control the liquid to solid ratio of the snow which determines the quality of the snow i.e. dry or wet snow.

2. Snow ingress in buildings and ventilation systems

2.1. Snow ingress in building components

Several kinds of questions are raised due to the ability of snow to enter openings in buildings located in snow drifting areas. One of the most important points concerns the ingress of snow in the ventilation system of a building.

In case of long exposure of building ventilation openings to wind and snow fall, a likely consequence is the partial or total obstruction of ventilation channels and filters by snow. Ventilation failure of the building causes an increase of the relative humidity inside the building which generates unhealthy indoor ambiances. When the ventilation system is able to recover due to the melting of the snow, it produces humidity absorption by filters which diffuse for a long time in the building. In turn, this induces mould growth and spread inside the building. According to studies, these kinds of problems are not rare in snowy regions of Europe since about 10% of building ventilation systems may be affected [2].

One mitigation strategy for this risk is to design a settling chamber upstream the ventilation opening which aims at reducing the air flow speed below the threshold suspension wind velocity. An air velocity of 1 to 2 m/s is usually agreed as the threshold settling velocity for snow. The main constraint of this strategy is to increase the building size with the settling volume.

An example of this kind of system from Greenland is shown in Fig. 2. The system includes a snow retention volume upstream the actual ventilation opening that behaves as a snow trap, collecting the snow to maintain the efficiency of the ventilation air flow.

A similar snow retention volume was studied with the use of full scale wind tunnel tests in parallel with field tests and numerical simulations. This allowed the comparative assessment of the efficiency of several configurations of the snow trapping volume [5]. To investigate the penetration of snow particles into the ventilation opening, a 2.5 metre cube was chosen to represent the building in which the ventilation opening was situated (Fig. 3).

The goal of the experiment was to find the amount of snow entering into the inlet when the opening was covered with different materials. The cubical shape was chosen for several reasons. The particle tracks of the snow particles are influenced by the air flow pattern around the building implying that the building shape is important for the amount of snow entering a ventilation inlet. Since a cube is a well-known shape with well-known and documented aerodynamics, this shape was found suitable for the experiments. The building should also be of a manageable size in the field experiments, a 2.5 metre cube is just about manageable

for manual work in the field. Even if the experimental site has a unidirectional wind direction, some adjustments of the direction of the opening was necessary just before the experiments started. For that reason, the building should be of a modest size and easily moveable. Fig. 4 shows the cube, its openings and internal baffles.



Fig. 2. Snow retention volume in building in Nuuk, Greenland



Fig. 3. Comparative testing of various air inlet snow traps in the wind tunnel

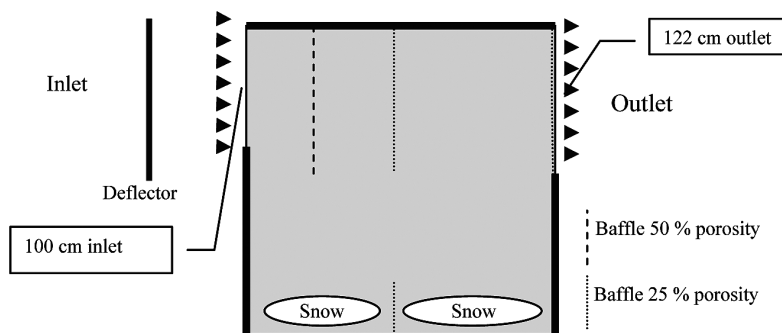

Fig. 4. Section of the cube - internal baffle arrangement

The openings of the cubes were equipped with inlets of different design to be able to study the snow penetration into the boxes during equal conditions. The differences consisted of different covering of the inlet. Three different inlets were tried; open inlet, inlet covered with insect netting of approximately 25 % porosity and a slotted wall with approximately 40 mm slots resulting in 30 % porosity.

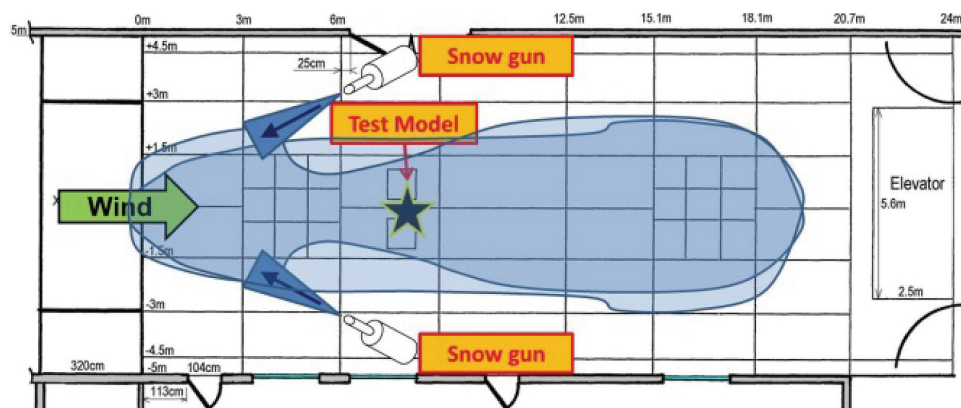

Fig. 5. Top view of the thermal unit test section, experimental setup for the snow ingress tests

Due to the experimental set-up and location of snow production systems, the snow flux obtained during the wind tunnel experiments can be locally much higher than in the field during a snow storm ($60 \text{ g/m}^2\text{s}$ versus $1 - 1.6 \text{ g/m}^2\text{s}$). Moreover, the snow flux in the field is highly dependent on the height above ground. Therefore, the ratio of snow flux upwind the cube to the snow flux into the cube is a relevant parameter to compare wind tunnel to field experiments. The snow flux into the cube is found by dividing the sum of the accumulated snow mass inside the cube and the snow escaping from the outlet with the area of the inlet and the exposure time, thus the unit $[\text{g/m}^2\text{s}]$.

The good agreement between the experimental methods allows to present the results from all inlet designs together in Fig. 6. This Fig. also presents the average air velocity in the inlet for the experiments in the wind tunnel. The average air velocity is lower in the case of an inlet with insect netting than in the case of slotted wall. However, the snow penetration ratio is lower for the insect netting than for the slotted wall. This indicates that the snow concentration in the air entering the cube is higher in the case of slotted wall compared to insect netting.

Visual observations of the snow particle paths show that the slotted wall produces local jets in the slots that entrain snow particles. Particles impinging on the blocked part of the inlet are deflected towards the slots and entrained into the cube. In the case of the inlet covered with insect netting, there were no local jets and more particles were deflected away from the inlet, resulting in a lower snow concentration in the air.

It is worth noticing that if an insect screen seems a good configuration for dry snow, the case of precipitation as wet snow completely blocked the inlet with insect netting after a short period of time. These snow particles are large and sticks to the surface they land on.

Ingress of snow directly into the building's roof, through the tiles, may cause serious damage in the building's attics, as humidity stagnation and reduction of insulation properties of materials will appear. This may be the case in most snowy regions of Europe. Although the use of roof underlays has been generalized in new buildings, it may still be necessary to reduce snow ingress between tiles by using dedicated tightness sealing. Comparative testing of several products can greatly accelerate the development of a particular design.

For such particular driving snow tests, the wind tunnel is operated in a way which enables the assessment of the tiles snow tightness in severe conditions. Since the making of snow is carried out while the wind is blowing at the appropriate test velocity, the location of the snow gun on the leeward side of the test models allow the freezing particles to go all along the wind tunnel circuit before reaching the roof models. This trajectory is long enough to freeze the water droplets producing dry snow (Fig. 7).

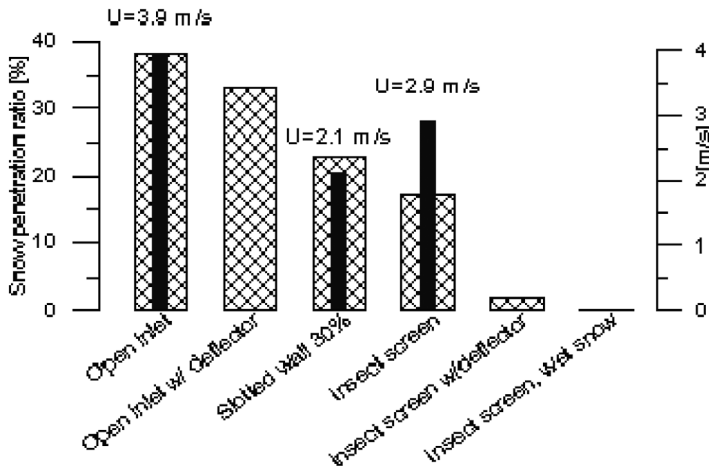

Fig. 6. Snow ingress ratio for all configurations

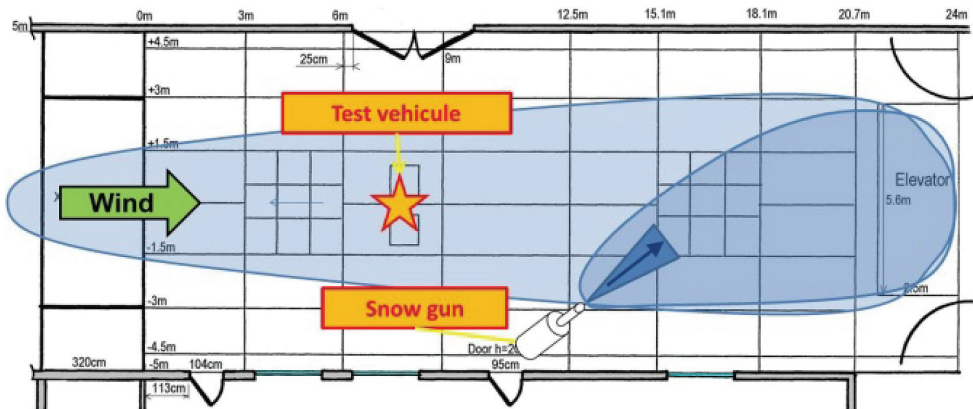

Fig. 7. Top view of the thermal unit test section, experimental setup for dry snow tests

The roof slope, the wind velocity and incidence are the test parameters to be varied in the experiment. The shape of the model itself influences the penetration of snow into the roof. As is the case in real roofs, the under pressure in the attic, which drives the snow ingress, can be adjusted naturally by using a duo pitched roof with similar tiles on both sides or by drilling holes on the leeward side which equilibrate the pressure of the inside roof with the wake zone.

A typical wind tunnel experiment may consider roof models with 2 different realistic roof slopes from 15° to 40° . The model can be made of closed boxes whose upper side reproduce a typical roof cover. The model should include a door to get inside the roof model and to evaluate the snow quantity collected.

In order to give order of magnitude of the collection phenomenon in the roof, it is interesting to mention that an event of 1 h may result in the collection of 1 to 2 kg of snow per square metre of model floor surface (Fig. 8).



Fig. 8. Snow ingress between tiles in the model attic

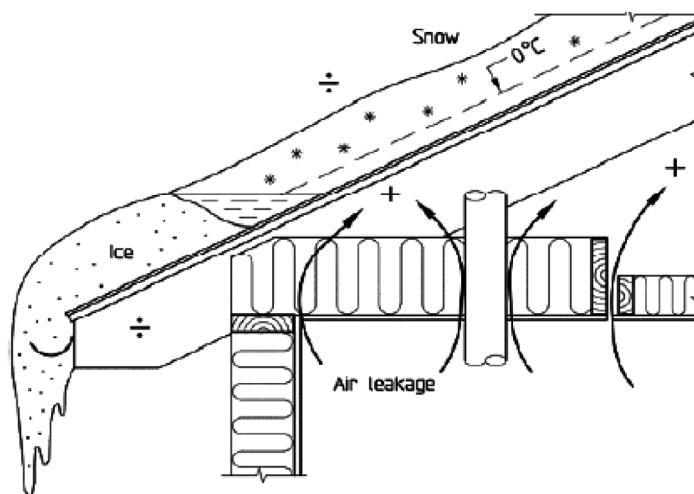

Fig. 9. Ice formation at the eave due to obstruction by snow of the ventilated cold roof

Ventilated cold roofs are commonly used in snowy regions of northern Europe. The objective is to make possible the ventilation of the under roof to maintain the temperature of the roof below freezing. Hence, the snow deposition on the roof is maintained in solid state during the winter and does not cause damages at the eave which would occur if the snow would partially melt due to unavoidable heat losses from the roof (Fig. 9). However, it is of paramount importance to protect the ventilation opening against snow ingress. The objective is to prevent the snow from entering the ventilated volume and avoid any obstruction that would cancel the benefit of ventilation.

One solution to avoiding snow penetration into the ventilated roof is to use a so-called eave cover. Several local variants of the eave cover have evolved in the Scandinavian countries. The solutions are based on reducing the air velocity in certain accumulation zones to make the snow particles settle before reaching the roof. Also different positions of the inlet have been tried, to avoid penetration of snow in the first place. Much experience and thought has been employed in the development of the local solutions.

A controlled comparative study is a valuable method to experiment and validate the design of the snowproof roof eaves. Such an approach has been undertaken in the wind tunnel [4]. To rate the performance of different eave covers, full scale tests have been performed in an environmental wind tunnel. The different eave covers were mounted on a building with duo pitched roof. The principle of ventilated, cold attic was applied in the experiments.

The measurements of the building were height = 279 cm, width = 300 cm, depth = 323 cm, and the angle of the roof was 24 ° (Fig. 10). The roof ridge was closed in the experiments, so no snow entered or escaped the attic through the ridge. To observe any possible end effects, the roof was divided in sections by width of 75 cm. One of the sections (sections b and B) was equipped with transparent roofing for observation of the snow penetration during the experiment. An overview of the different experiments (eave configurations on the windward side) is shown in Fig. 11 (right).

During the blowing phase, the wind velocity was set to 15 m/s in order to observe snow drifting. Wind tunnel data were obtained from several experiments of 60 and 120 minute periods depending on the snow penetration in the roof construction.

During the experiments, the snow transport in the wind tunnel was measured continuously to assure the same experimental conditions for every test. Mechanical snow traps with the shape of a tube with one end closed by netting were used for measuring the snow flux in the wind tunnel. The mean snow flux in the wind tunnel was 1.75×10^{-2} kg/m²s 135 cm above the floor, which corresponds well to the snow flux in a real snow storm of 15 m/s and no precipitation.

The snow concentration in the channel connecting the eave to the attic is defined as:

$$c = \frac{\text{Snow in attic} / \text{Test period}}{(\text{Area of channel}) \times (\text{Air velocity})} \quad [\text{kg/m}^3] \quad (1)$$

c is regarded as a measure of the effectiveness of the whole construction to withstand snow penetration. The construction with the lowest snow concentration in the inflowing air has the best ability to prohibit snow penetration into the roof.

The ratio of the snow concentration in the wind tunnel to the snow concentration in the channel connecting the eave to the attic provides a quantitative way to assess the effectiveness of the different constructions. Configuration 2 was considered as reference as the most commonly used construction in Norway.



Fig. 10. Wind tunnel test of snow ingress through ventilated roof eaves

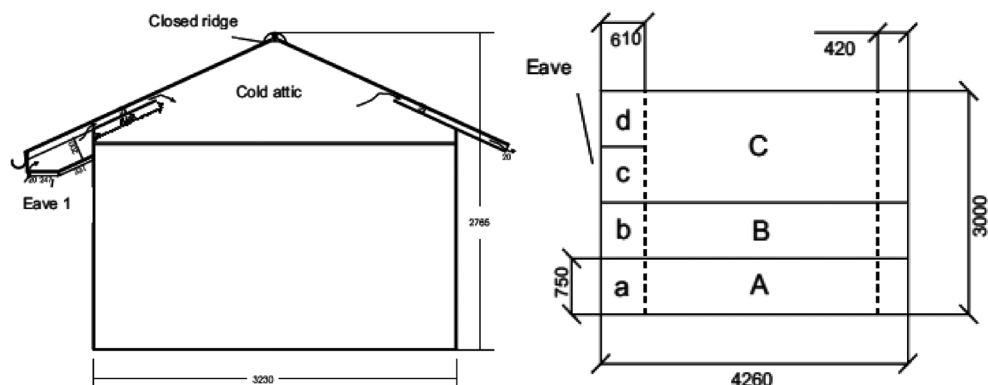

Fig. 11. Section and schematic top view of the windward roof pitch with division of the ventilated attic and eave construction

The experiments show that the design of the eave construction is important for the snow penetration into the roof. The design in experiment 5 gives the best result in avoiding snow penetration into the roof. However, this solution also introduces a flow resistance, which is higher than in experiment 2. The result of the increased flow resistance might be a reduced ability to remove moist air from the construction. Such a design is therefore favourable in a windy climate where the wind will produce an airflow in the channel for a longer period of the year. In areas of more moderate wind, and where the snow penetration problem also is smaller, the design in experiment 2 might be sufficient to avoid snow penetration and still maintain adequate ventilation of the roof.

Other interesting results were obtained, as the justification of the position of the ventilation opening should not be close to the wall, since this increases the quantity of snow transported into the attic. The reason for this is probably that large parts of the snow particles impinging on the windward are transported upwards along the wall, thus entering the ventilation opening. A deflector on the building wall will not improve this result significantly.

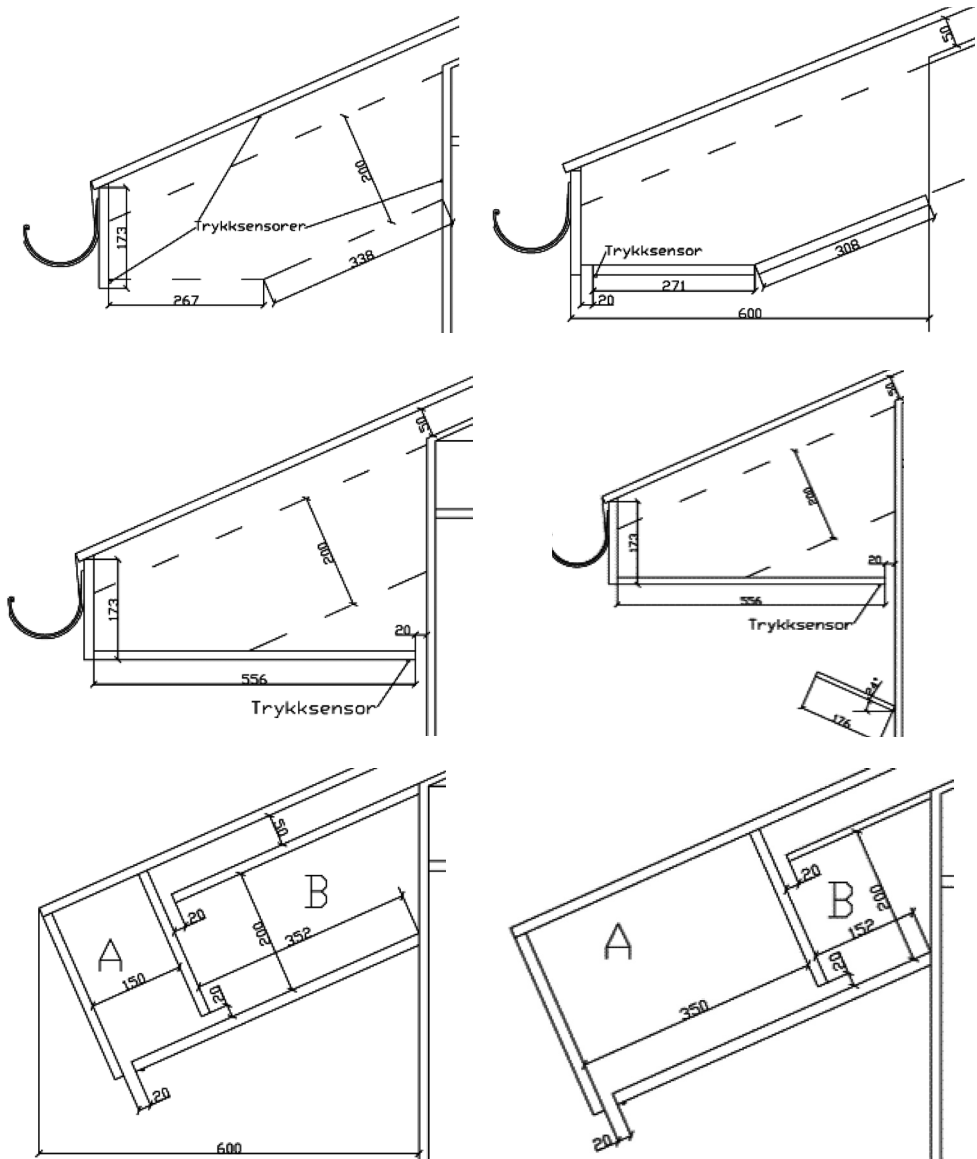

Fig. 12. Eave construction configuration included in the comparative test (construction 1 to 6)

For other alternative designs of ventilation openings in roofs or cladding, the position and design of the opening is probably the most important factor in reducing snow penetration. The opening must not face the impinging snow particles directly and it should be positioned away from surfaces or obstacles capable of funnelling blowing snow particles into the opening. Even with a small snow concentration entering the roof the amount of snow can be considerable. The air velocity of the entering air should therefore not be too high.

2.2. Interaction with vehicles and industrial equipment

Snow ingress and accumulation into the air inlet of engines can cause severe damages to vehicles. Amongst the most critical conditions for road vehicles, let us mention the follow-up configuration where a vehicle follows one or several other vehicles. The snow falling is added to the snow picked-up by vehicles ahead made of fine particles. The ingress capacity of the fine particles is high and can impact several systems as engine air intake, Air conditioning system, wipers or brake systems.

Similar situations are experienced by helicopters that can be maintained in stationary flight over snow covered ground. In this case, it is important to locate and assess the quantity of snow that accumulates in the heated air intake channel of the turbine engines. The risk is to observe a local snow accumulation that could be released in large blocks and damage the turbine. The remedial strategy involves heating mats inside the air intake whose efficiency needs to be assessed according to standard procedures.

Test configurations commonly used during the design stage of new road vehicles deal with most of the aforementioned subjects. The experimental set-up enables the operation of the vehicle, engine on, fitted on a roller bench that simulates the resistant force due to drag. The test in snow storm conditions is carried on until the engine stops. Sensitivity to high snow concentration in the air is assessed by weighing the snow collected in the air filters.



Fig. 13. Operation of vehicles in snow conditions



Fig. 14. Snow test of vehicles in the wind tunnel

3. Snow jamming of mechanical systems

Another example of the interaction of snow with building equipment with potential severe consequences concerns the operation of smoke vents. The validating standard test method of smoke vents makes use of simulated loads with metallic plates or sand bags. Field tests of smoke vent under snow loads demonstrated that there are serious risks with certain types of smoke vents, made of multiples louvers, to observe jamming due to icing at the interfaces. In other cases, although the smoke vents would actually open, the snow cohesion induced compact blocks that remain attached to the louvers or even above the open louvers thus drastically reducing the free opening necessary for the efficient smoke exhaust in a fire situation.

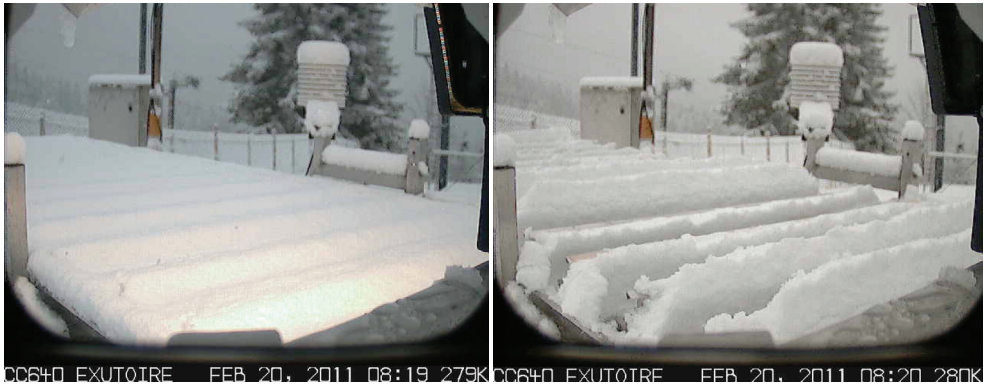

Fig. 15. Field test of smoke vent opening under snow loads

Climatic wind tunnel testing allowed simulating many opening situations of a smoke vent under controlled snow loads. The preliminary step to validate the wind tunnel approach was reproducing the natural conditions with the same test specimen used for the field tests.

For the snow load simulation in the climatic chamber, the tests were made by using two snow guns, located on each side of the test chamber at 9 m from the air nozzle. The snow guns were pointed against the wind (Fig. 5). In this configuration, the water sprays are re-oriented from their initial trajectory by the air stream of the wind tunnel. This enhanced both the freezing of the droplet and the uniformity of the snow fall in the test chamber. The air temperature was controlled at -10°C or -15°C , and the wind velocity was maintained at a few m/s.

It is noticeable that, as observed in the field, when the opening succeeded, the snow layer was broken by the louvers movement but remained attached to the louvers. In other cases, with the same load, the smoke vent did not open when the electric opening system was triggered. The vent remained in the closed position although the current absorbed was twice the current required for the unloaded configuration.

In some other case, when the vent opening was manually forced, the snow cover was not broken in pieces but remained solid above the louver edge in vertical position. In all cases, the aerodynamic free area was significantly reduced (Fig. 16).



Fig. 16. Smoke vent opening test with snow loads

This study showed that the standard test procedure of snow load of the smoke vent (load simulated by metallic plates) is not equivalent to snow load tests performed with real snow and thus inadequate for testing the functionality of smoke vents.

A single load, placed on the vent louvers does not produce the same constraints as a snow layer of equivalent mass. The cohesion forces of the snow are likely responsible for this and it is difficult to render in a simple manner the additional constraints that remain during the opening sequence of the vent. The wind tunnel test procedure demonstrated the capacity to realistically assess the capacity of smoke vent to operate in case of snow loads.

4. Wet snow accretions on building facades and high speed trains

4.1. The case of high rise buildings

Questions regarding snow accretions to building façades are more and more frequent. As far as high rise buildings are concerned, the questions deal with risk assessment in urban areas.

In these cases, the recommended approach requires a statistical snow fall study at the site of the construction, associated with an experimental modelling of snow icing of a full scale element of the skin façade. The experimental study provides quantitative and qualitative information regarding the snow accumulation process.

For a high rise building surrounded by a dense urban environment, it is sometimes necessary to assess the impact of more complex climatic scenarios. The heat generated by solar irradiation of the top parts of the building that melts the snow and ice is an example of this. The dripping water can potentially refreeze at the shaded bottom parts of the building. This is the case when the design ice or snow load can be far higher than the load due to direct exposure to precipitation as deduced from the climatology study (Fig. 18).

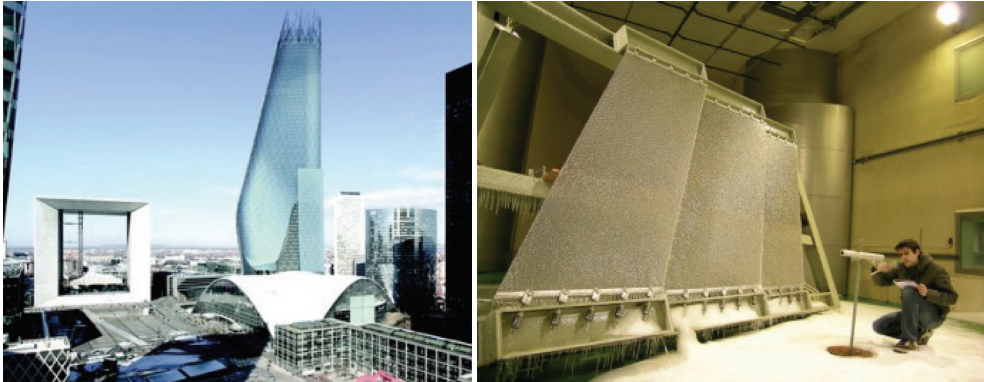

Fig. 17. Full scale icing test of double skin façade of high rise building

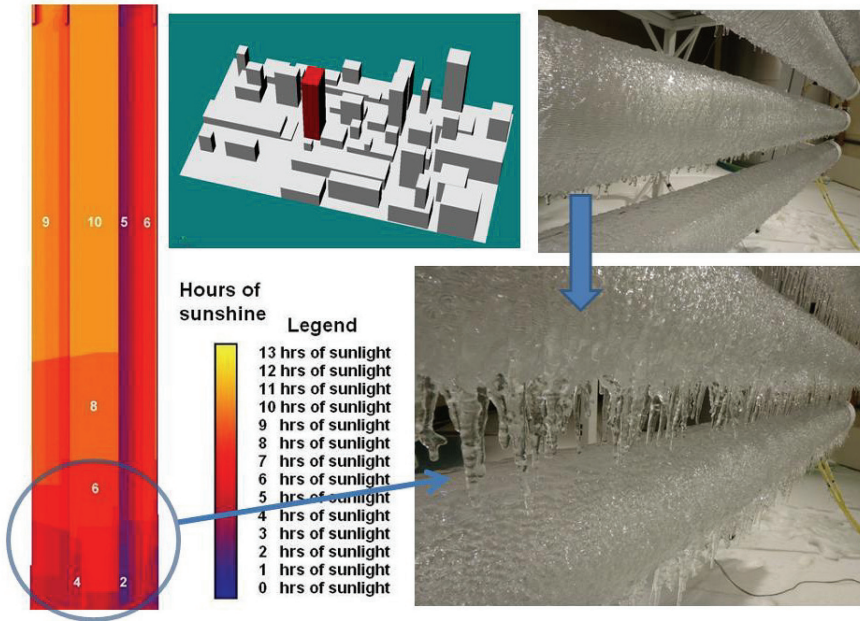

Fig. 18. Solar irradiation of high rise building in urban environment (melting of ice at the top of the building and re-icing at the bottom)

Apart from the additional load induced by snow that has to be taken into account for the dimensioning of the structure, the risk associated by falling pieces of ice during melting stage increases in the urban environment. The risk is highly dependent on the shape and porosity of the facade elements subjected to icing. Moreover, scenarios of successive melting and icing period determine the size and shapes of ice pieces that may fall. Once again, the experimental modelling provides valuable information regarding the risk as well as the possibility to design and test systems to reduce that risk.

Wind tunnel simulation can also show unexpected situations as the one observed during a de-icing test of facade elements. Solar radiation and ambient warming induced local melting between the ice and the material. Ice is actually a semi-transparent material and the visible solar radiation was absorbed by the elements of the support which generated a rise in local temperature above freezing point. The gap between the ice and the support made the pieces of ice sensitive to wind and prone to falling.

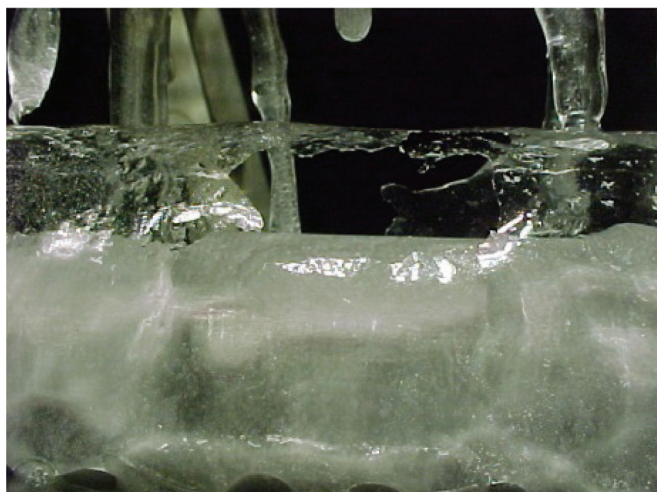

Fig. 19. Local melting of ice at the interface with structure material due to solar radiation

4.2. Railway vehicles

To maintain the development of high-speed train traffic, railway operators have to face extreme conditions, in particular during winters, with impacts on both infrastructure and rolling stock, and associated maintenance. Usual major consequences of snowfalls are both on traffic regulation with cruising speed reductions and on rolling stock with severe damage (underbody structure, windows) due to ice and snow accretions and shedding, leading for instance to ice-drop ballast projection.

In order to minimize the impact of extreme winter conditions on high-speed trains, wind tunnel experiments were undertaken as a part a research program conducted by the French railway company SNCF. The aim was to explore solutions to reduce the snow accumulation on trains. The first part of the study was dedicated to collecting data and identifying the mechanism of snow accumulation by performing tests in a climatic wind tunnel.

Most of the tests were performed with one snow cannon located on the central axis of the test section (Fig. 20). The snow cannon was set up in a counter-current configuration to enhance the spatial uniformity of particle concentration in the air flow. This configuration also ensures that particles are carried out to the test structure in equilibrium with the air flow.

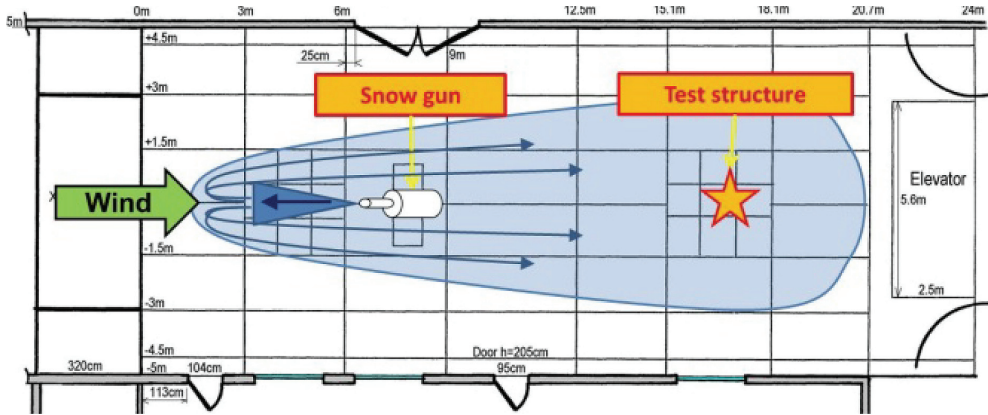

Fig. 20. Top view of the thermal unit test section, experimental setup for the snow tests

Generic simple-shaped prisms and a railway shape geometry at 1/2 reduced scale were used. The obtained results consist in snow and ice growths and localizations, with the influence of different parameters, with particular attention to the wind speed, air flow temperature, characteristics of snow particles (i.e. density, liquid water content and mass flow) and their behaviour on various angles of impact.

Two superimposed planes were used to support the prisms outside the boundary layer of the wind tunnel air flow. The prisms were located underneath the supporting planes to include the impact of the horizontal plane on the accretion phenomena to the vertical surfaces of the prisms in the simulation. This arrangement intended to mimic the volume locations under a TGV floor.

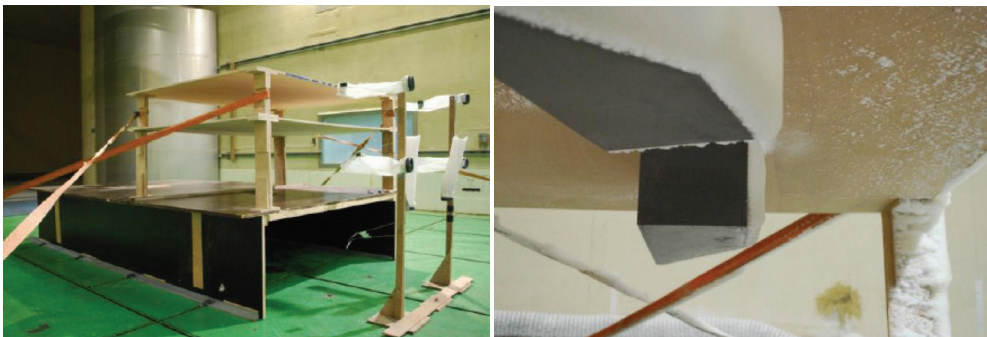

Fig. 21. Experimental set-up supporting the simple-shaped prisms in the wind tunnel test section (the wind comes from the right of the picture)

The snow concentration was derived from the collected snow mass regarding the collection area, the local wind velocity and the test duration. The average value of the snow concentration was 11 g/m^3 .

The prisms have been designed to explore various inclination angles of the walls, two sizes, from 0° to 90° , with respect to the main flow. The measurement of the mass of snow captured by each face during a run, enabled us to get a table of mass flux expressed in $\text{kg}/\text{m}^2\text{-s}$ depending on the face area and the duration of the run.

To normalize the results, the snow mass fluxes have been divided by a 'reference mass flux'. This reference mass flux is measured on the face perpendicular to the flow, which gets the highest flux and is associated to a ratio of 1. To resolve uncertainty problems linked to the inhomogeneous aspect of the snow cloud (which presents higher density in its centre), several reference faces have been designated, according to their distance from the centre so that, in the end, the only parameter considered is the face slope angle versus main flow direction.

Some results were excluded when the inclination angle was altered by a large quantity of snow, inducing a deformation of the shape, and modifying the inclination angle of impacting particles.

The second part consisted in reproducing these mechanisms using numerical simulations whose methodology has been validated by comparing computational results to measurements on both the prisms and the railway mock-up [1].

In order to supplement the prism measurements with results on a more realistic under floor train geometry, a railway vehicle model at 1/2 reduced scale was designed. The model simulates two parts of a TGV body including the connection between two railroad cars (Fig. 22). The overall train model was 8m long. A bluff body shape upstream the bogie was designed in order to model the aerodynamic influence of the front part of the train.

An entire bogie was reproduced. The bogie model was simplified compared to a real one, but the main elements which may collect snow were reproduced, including the brake system (Fig. 23).

In order to reproduce the air flow underneath the train body, the model was suspended. An additional floor simulating the track was fitted 70 cm above the wind tunnel floor. The height of the floor was intended to maintain the area of interest outside the boundary layer of the wind tunnel. The rotation of the wheels was simulated by a belt drive system and an electric engine.

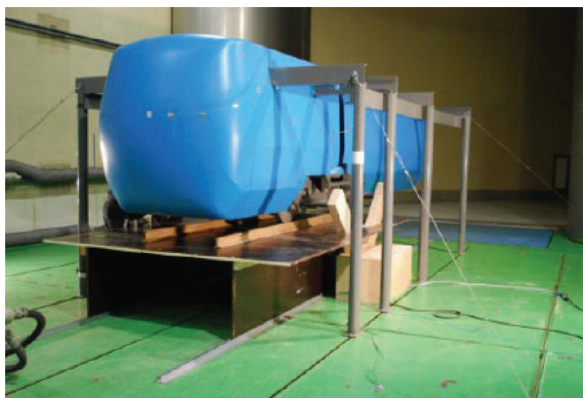

Fig. 22. TGV model set-up in the climatic wind tunnel

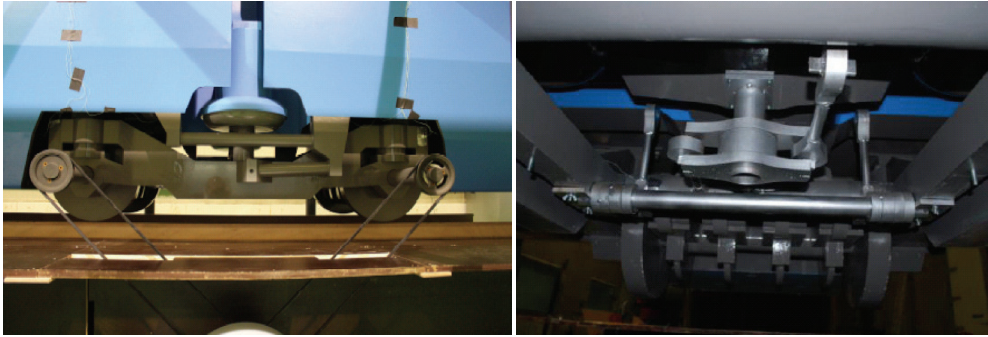

Fig. 23. TGV bogie model including anti-roll bar and the bogie-car drive system



Fig. 24. Snow accumulation in the bogie cavity (wind tunnel model and real TGV train)

At the end of each test period, the measurements of accumulated snow were made and photographs were taken at predefined locations and angles of view (Fig. 24). The snow accumulated on specific spots was collected and weighed.

A CFD methodology has been developed concurrently with the wind tunnel experiments. The measurements made on the prismatic bodies with various sizes and shapes allowed fast and precise tuning with the exploration of a large panel of parameters. The resulting simulation chain has been deployed on the more complex geometry, reproducing the TGV car details, and the workflow has been enriched with the mesh growing, in respect with the snow accretion rate obtained, and the associated volume of snow calculated.

4.3. Experimental and numerical modelling of snow accretion

The availability of realistic models that enable to predict the risks of snow and ice accretion on building or vehicle elements requires a better knowledge of the climatic constraint. In particular, the possibility to assess the sticking capacity of the snow particles at time of impact is important.

Such a modelling is possible if one can assess the liquid water content of the snow at the impact time. Recent PhD these have shown the primary effect of the liquid water content of snow on the snow accretion mass and volume [6]. The experimental approach was based on the assessment of wet snow accretion formation on simple geometric shapes. Cylinders were placed in the snow particle flow produced in the climatic wind tunnel. If all other parameters were kept constant, the ambient temperature setting (from -10°C to -2°C) enables the thermodynamic state of the snow particle at time of impact to be modified. It is then possible to assess the effect of the liquid water ratio on the accretions and perform a parametric study.

A numerical model for two-phase flows simulation has also been developed in parallel. The study conducted has been set up mainly to identify the most important parameters that drive the accretion phenomenon.

The results obtained with -10°C and -2°C experimental tests provided the limiting cases of the study as being the conditions where the accretion was either very thin and could not be weighted or too humid and could no longer be considered as actual snow.

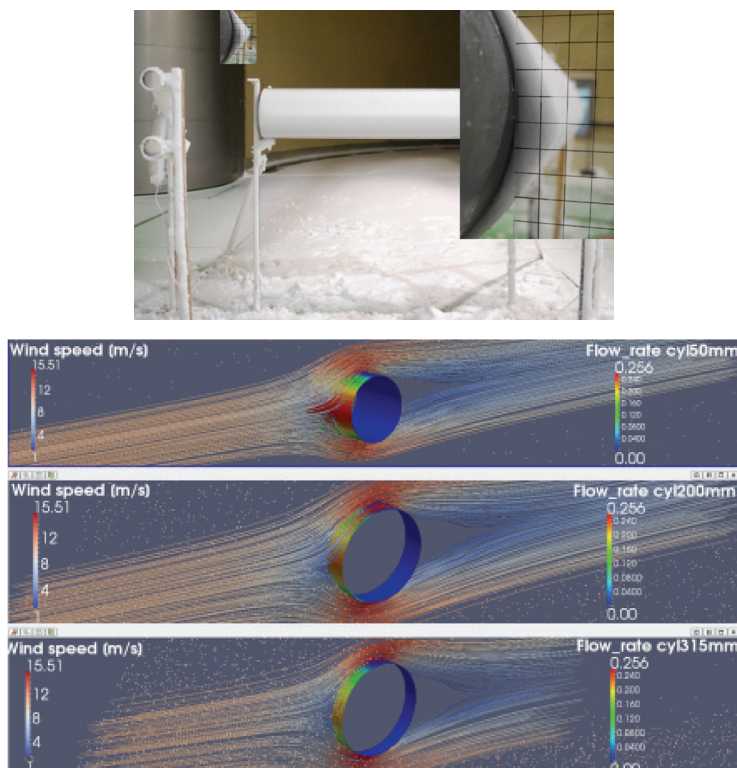

Fig. 25. Experimental and numerical modelling of wet snow accretion on a cylinder

With the three intermediate ambient temperatures, 6°C , -5°C , -4°C , one can observe the evolution of the accretion sizes to the structures (Fig. 26).

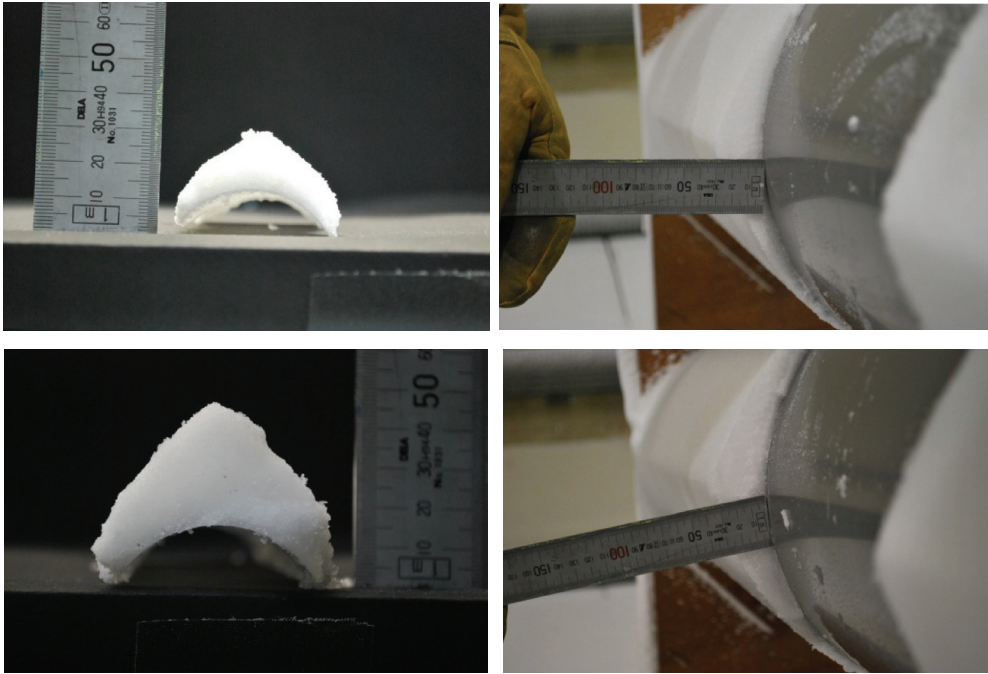

Fig. 26. Examples of wet-snow accretion (ambient temperature -6°C top and -4°C bottom)

To better describe the accretion on the test structure a parameter β has been defined as the ratio of the normalized mass of snow accreted to the cylinder ψ_a to the incident flux of snow φ_s , $\beta = \psi_a / \varphi_s$.

With the three intermediate ambient temperatures, 6°C , -5°C , -4°C , one can observe the evolution of the normalized collection parameter $\beta^* = \beta_t / \beta_{-6^{\circ}}$ which shows how the mass of accretion grows for both cylinders (Fig. 27). Qualitatively, one can observe how the augmentation of temperature induces accretions more humid and dense on the cylinders.

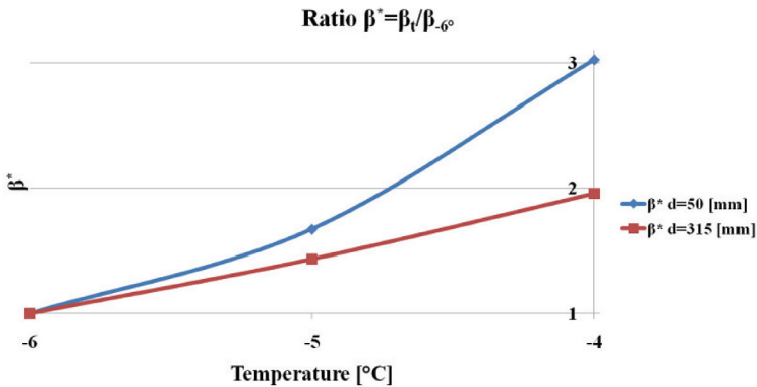

Fig. 27. The β^* coefficient as a function of ambient temperature

The comprehension of these parameters, which govern wet snow accretion, leads to the possibility to undertake a numerical study to characterize the different accretions by using a so called “stick-function” for wet snow particles. The study will also aim at producing an experimental database of climatic wind tunnel icing simulations for comparisons with outdoor real-scale phenomena.

The criterion implemented in the numerical modelling of accretion takes into account the angle between the particle path at the impact with the surface and the normal to the surface, i.e. if this angle α_{imp} is lower than a threshold angle α_t the particle sticks to the surface. The approach has simulated accretion shapes showing fair similarities with the experimental. However, it fails to predict accretion on the upper and lower part of the cylinder. This might lead to a more comprehensive model to take into account the particle energy, the liquid water ratio and the angle of impact that have been identified as the crucial aspects involved in the wet snow accretion process.

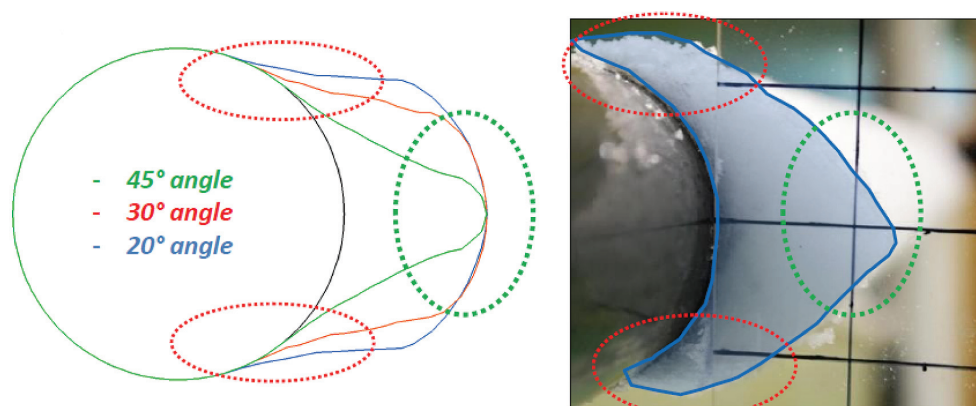

Fig. 28. Comparison of accretion shapes obtained by numerical modelling with experimental results, analysis of the upper and lower part of a cylinder $d_{cyl} = 50$ mm: (a) numerical simulation $\alpha_t = 20^\circ, 30^\circ$ and 45° (b) experimental result

5. Discussion and perspectives

To reduce the risks induced by associated wind and snow events, proper design of structures and systems that takes into account the actual climatic conditions is a priority.

Due to the diversity of situations, i.e. snow ingress or accretion and accumulation in buildings and vehicles, there is no single approach to investigating these situations and assessing solutions to alleviate the risks. But in all cases the use of experimental facilities that provide controlled ambiances and snow making capacities is valuable.

The climatic wind tunnel provides the controlled ambient environment which allows the influencing variables to be isolated and the causes of a phenomenon to be analysed. Nevertheless, the wind tunnel remains a simulating situation of the natural environment. From

this point of view the use of experimental field tests are useful to validate lab simulations. Although there is a wide range of potentialities in climatic wind tunnels, many conditions remain absent from the material and financial possibilities. In some cases, numerical modelling can supplement the experiments in wind tunnels. A parallel approach, experimental and experimental field tests, seems the most productive way since it enables the pitfalls of each method to be avoided. It seems this should be the favoured method in the future.

Common to all of the examples given in this paper is that no absolute solution has been proposed. The presented results provided the basis of analysis for future developments. The main benefit of the experimental work, and this seems crucial, is the ability to predict the severity of the observed phenomena. This is the essential first step, whatever the corrective action further considered, design improvement, or maintenance action is.

With regard to the ingress of snow in ventilation systems, optimization of air inlets is certainly possible. Similarly, reducing the risk of snow accretion on structures and vehicles may be due to a better design for a de-icing system and shape optimization. But in any case, it is not certain that this eliminates the problem permanently. However, an intervention strategy will result from the a priori assessment of the real risks.

Analytic experimental means to characterize the risk of snow and ice accretion are still missing. This would enable the theoretical and experimental modelling of the phenomena to be developed. Such a modelling seems possible provided one can measure the liquid ratio content of the snow. Early tests achieved with a dedicated probe derived from a measurement device used in aeronautics to assess icing conditions are promising.

This is a derivative of a probe used in air born cloud physics studies. The so called “Nevzorov” probe combines a heated convex and concave shape system. The two-phase flow behaviour around these elements enables the solid and liquid particles to be differentiated. The convex element only receives the liquid fraction of the particles, since the solid part rebound and is carried away by wind, while the concave element captures all the particles. The surface temperature of the probes is kept high to allow complete melting of the particles that impact. The detailed heat balance of the probes makes it possible to deduce the amount of liquid and solid water in suspension in the air flow.

An interesting protecting strategy is provided by icephobic coatings. If these kinds of coating do not yet fully prevent ice and snow deposition, they greatly reduce the adhesion. Hence, the mechanical movements of the iced structure enable the fall of the accretion. Similarly, during the melting phase, the protective coatings enable the icing cover to be reduced more quickly.

The authors acknowledge the European Commission and SNCF for the financial support of studies presented in this paper.

References

- [1] Allain E., Paradot N., Ribourg m. Delpech P., Bouchet JP., De la Casa X., Pauline J., *Experimental and numerical study of snow accumulation on high speed trains*. Proc. 49th International Symposium on Applied Aerodynamics, France, Lille 2014.

- [2] Asikainen, V., Pasanen, P., *The prevention of snow entrance to the HVAC-system*, Proceedings of Clima 2007 WellBeing Indoors.
- [3] Delpech P., Dufresne de Virel M., Tétard Y., *Snow loads testing of smoke vents*, Proc. 7th International Conference on Snow Engineering, Japan, Fukui 2012.
- [4] Thiis T., Barfoed P., Delpech P., Gustavsen A., Hofseth V., Uvslokk V., Dufresne de Virel M., *Penetration of snow into roof construction – wind tunnel testing of different eave cover designs*, Journal of Wind Engineering and Industrial Aerodynamics, Vol. 95(9), 2007, 1476–1485.
- [5] Thiis T., Delpech P., *Measurements of snow penetration in to ventilation openings in buildings*. Proc. 6th International Conference on Snow Engineering, Canada, Whistler 2008.
- [6] Vigano A., *Experimental and Numerical modelling of wet snow accretion on structures*, PhD thesis, France 2012.