



Politechnika Krakowska

Biblioteka Politechniki Krakowskiej



100000313383

O BUDOWIE
DRÓG I MOSTÓW.

PRZEBZ

Stanisława Jarmunda.

Tom I.

PRACE PRZYGOTOWAWCZE.

POMIARY. — POZIOMOWANIE.

TABLICE.

WARSZAWA.

HENRYK NATANSON.

1861.



161704 / 1a

II - 352555

Wolno drukować, pod warunkiem złożenia w Komitecie Cenzury, po wydrukowaniu, prawem przepisanej liczby egzemplarzy.

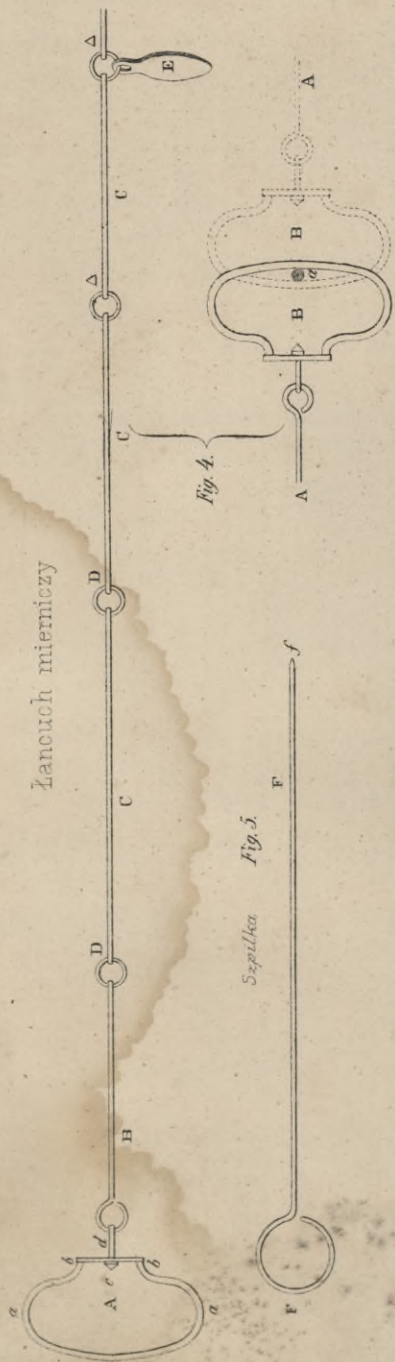
w Warszawie, d. 26 Lipca (7 Sierpnia) 1860 r.

Starszy Cenzor,

ASSESSOR KOLLEGIALNY, T. Hertz.



Łanouch mierniczy



Szeptelka Fig. 5.

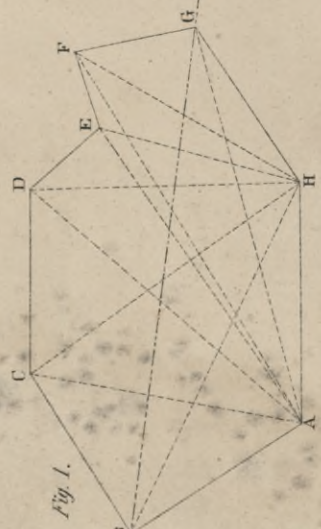
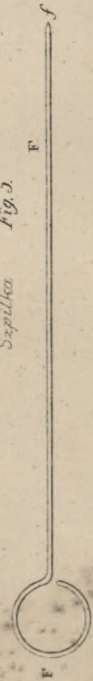


Fig. 1.

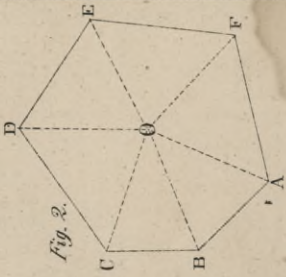


Fig. 2.

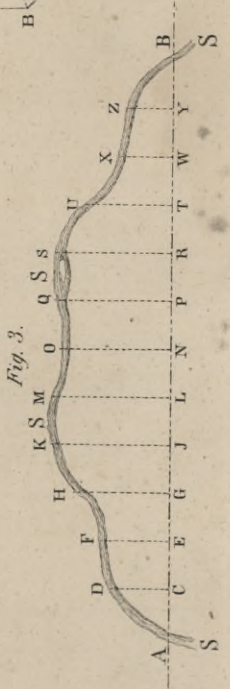


Fig. 3.

Łanouch sprężynowy

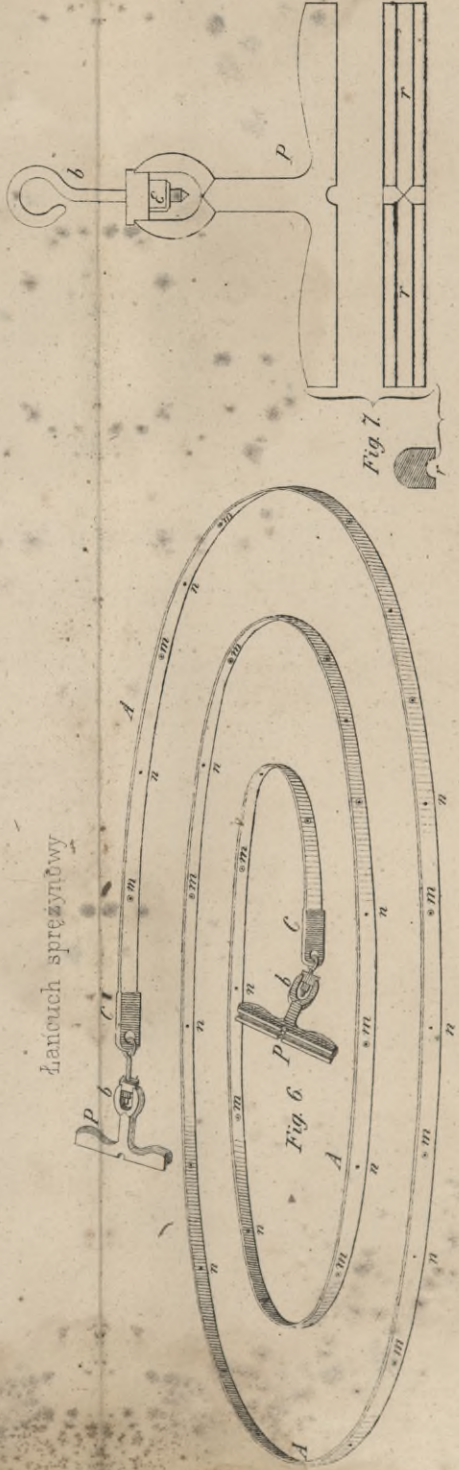


Fig. 6.

Fig. 7.

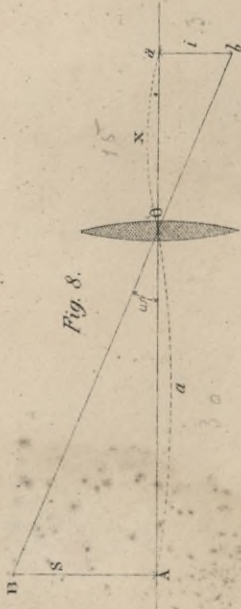


Fig. 8.

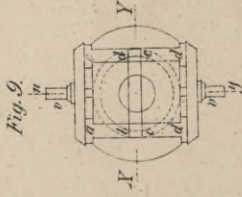


Fig. 9.

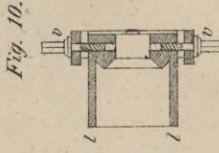


Fig. 10.

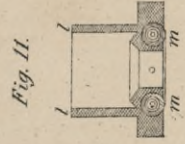


Fig. 11.





Stadye



Fig. 13.



Fig. 12.

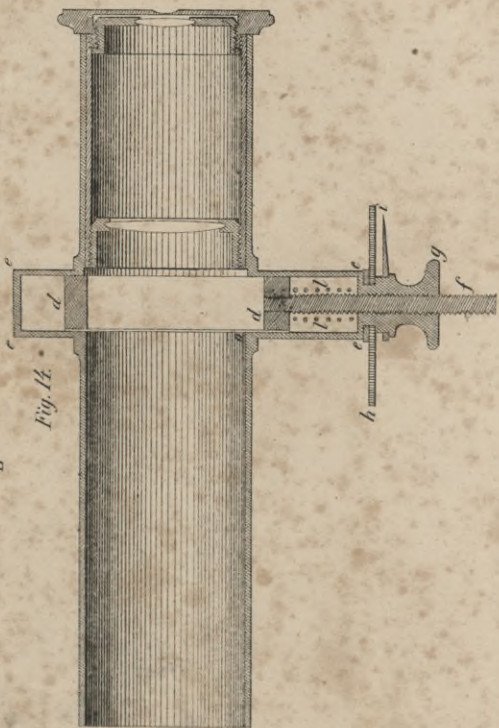


Fig. 14.

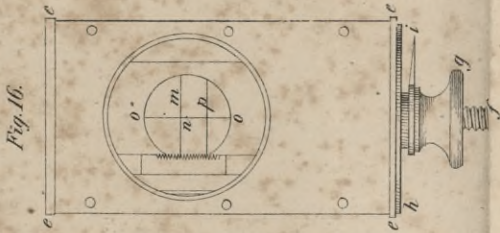


Fig. 16.

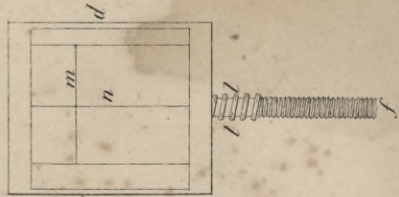


Fig. 17.

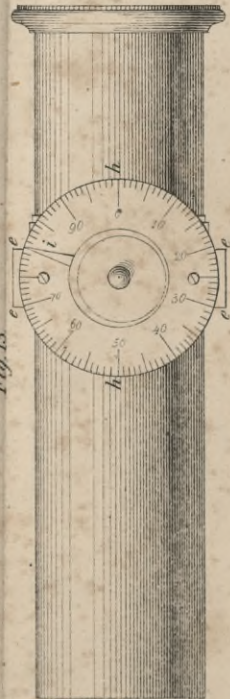


Fig. 15.



Fig. 18.

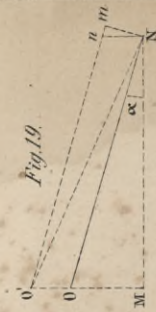


Fig. 19.



Fig. 21.



Fig. 22.

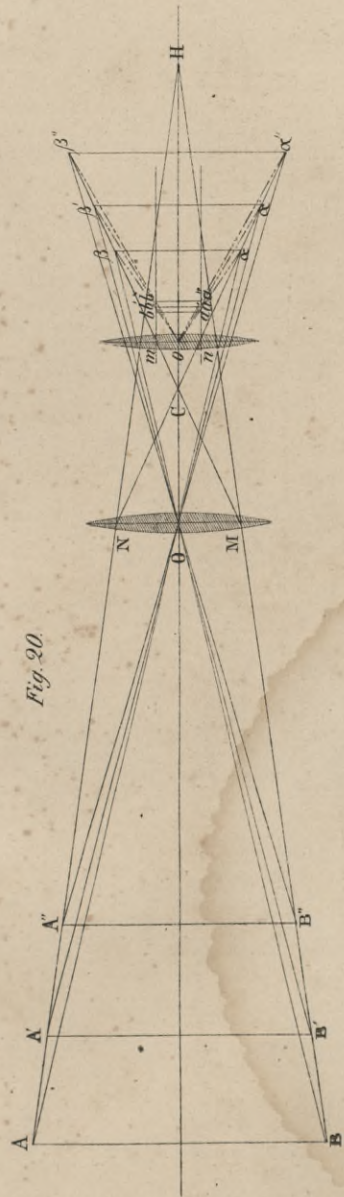
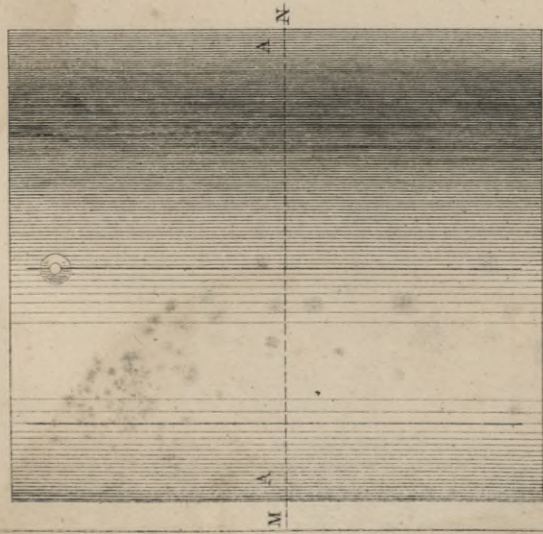


Fig. 20.



Węgielnica inwentuza

Fig. 25.



Pantometr

Fig. 30.

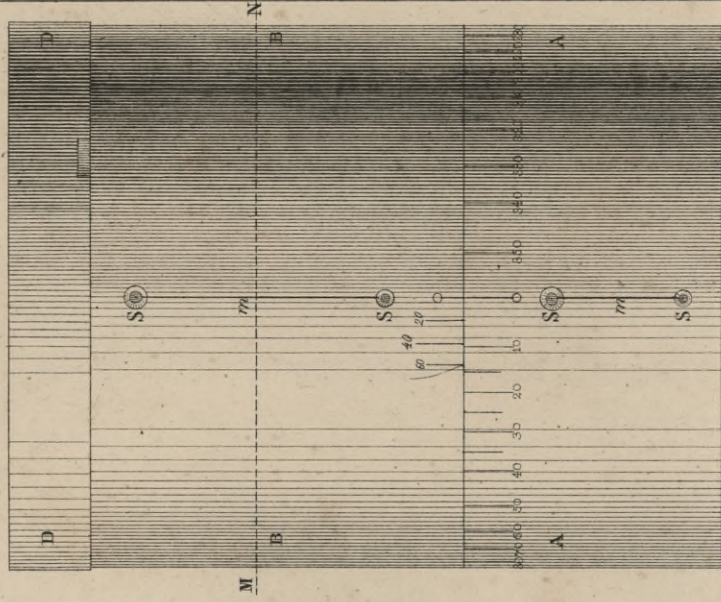


Fig. 28.



Fig. 29.



Fig. 26.

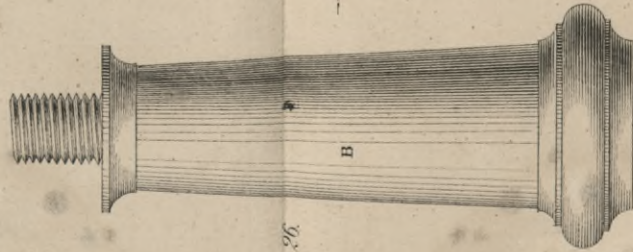


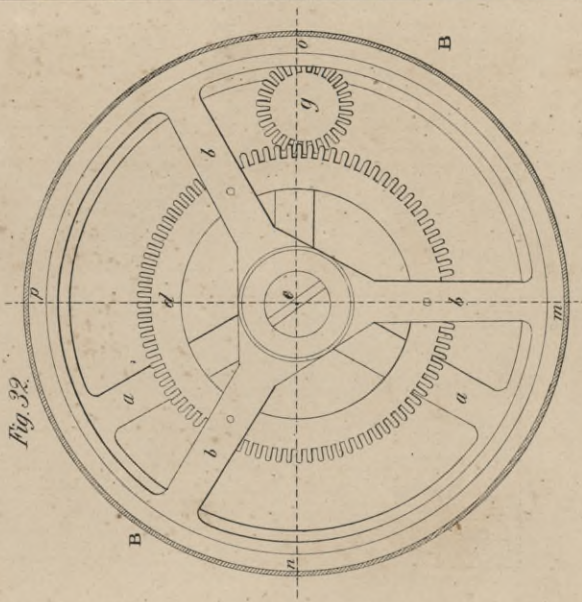
Fig. 31.



Fig. 27.



Fig. 32.





Katomiar

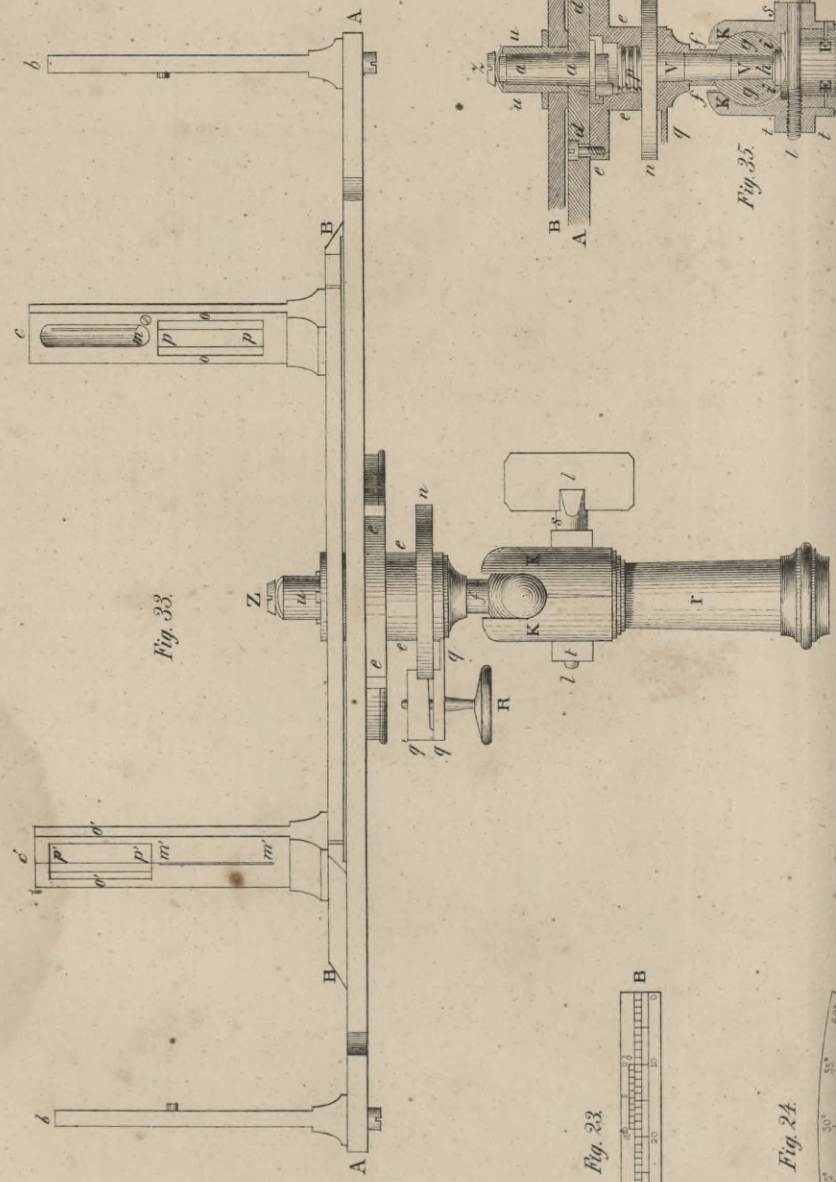


Fig. 33

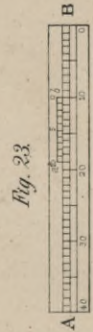


Fig. 33

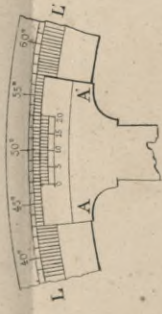


Fig. 24

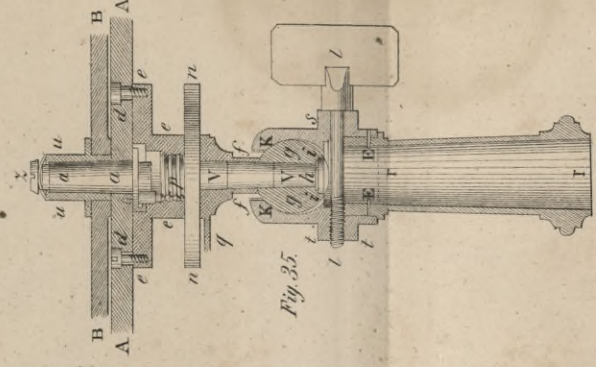
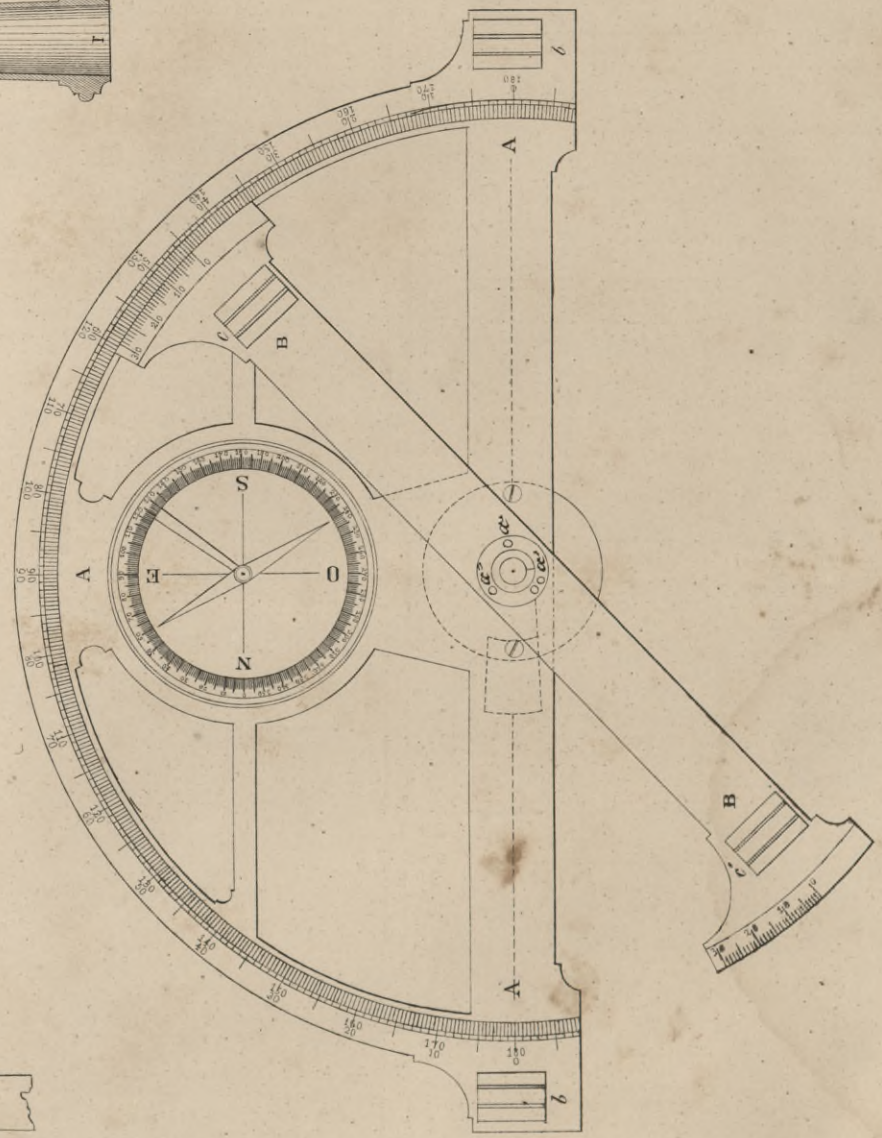


Fig. 35

Fig. 34

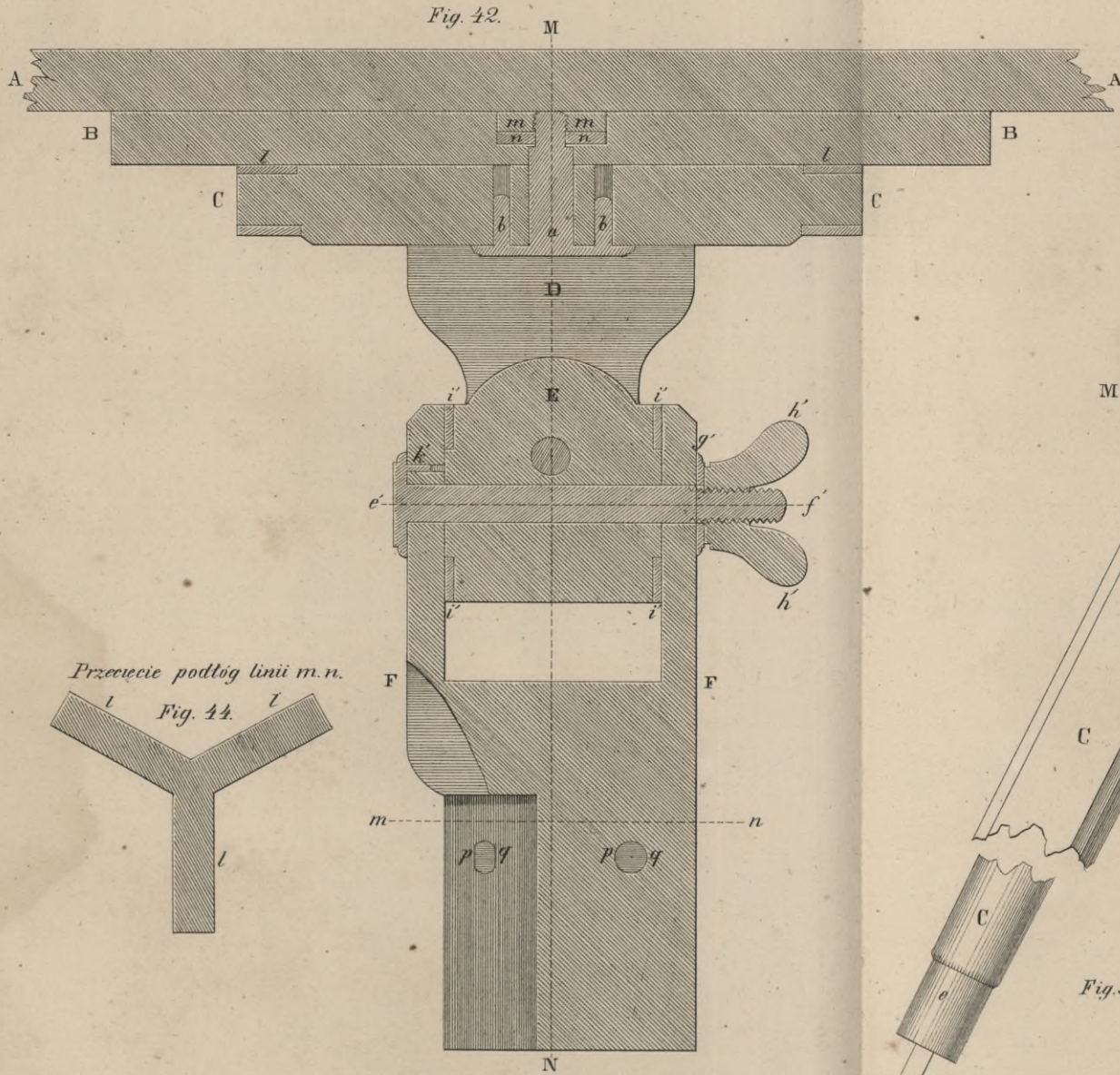






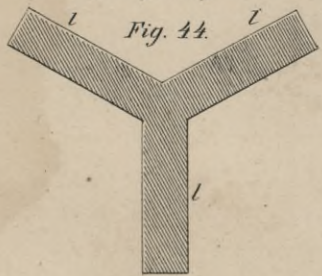
Przecięcie

Fig. 42.



Przecięcie podług linii m.n.

Fig. 44.



Trójnóg

Fig. 36.

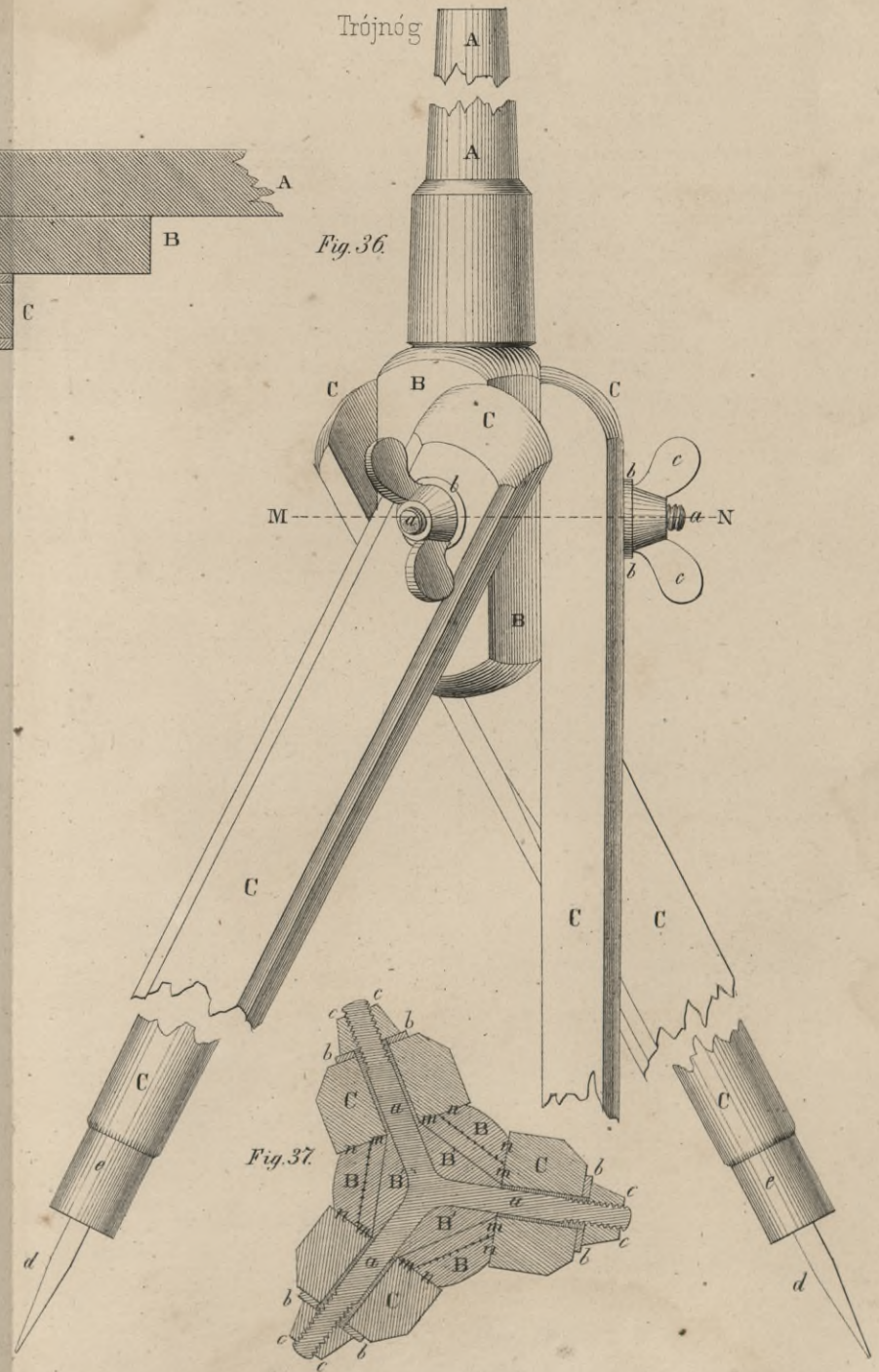
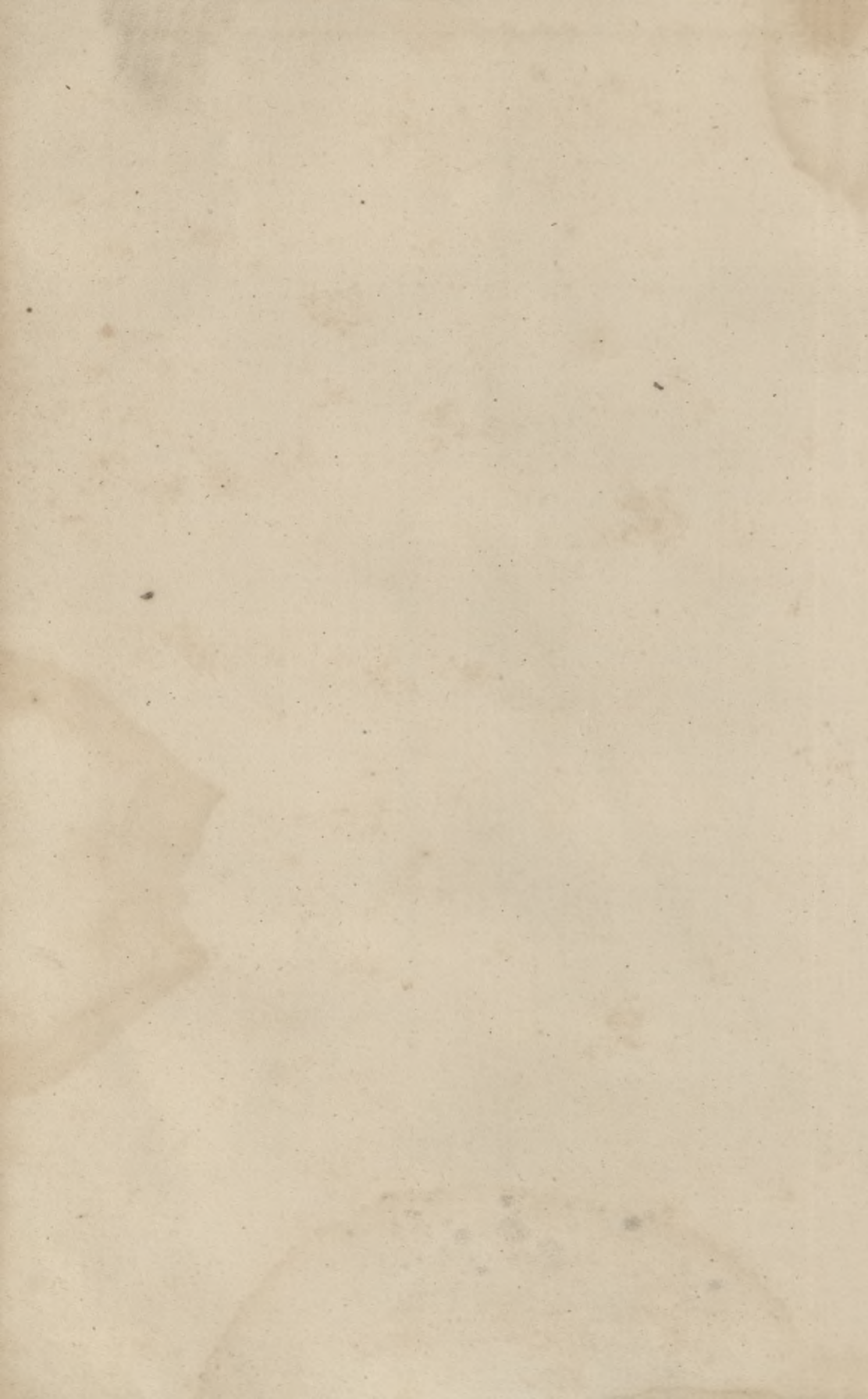


Fig. 37.





Busola

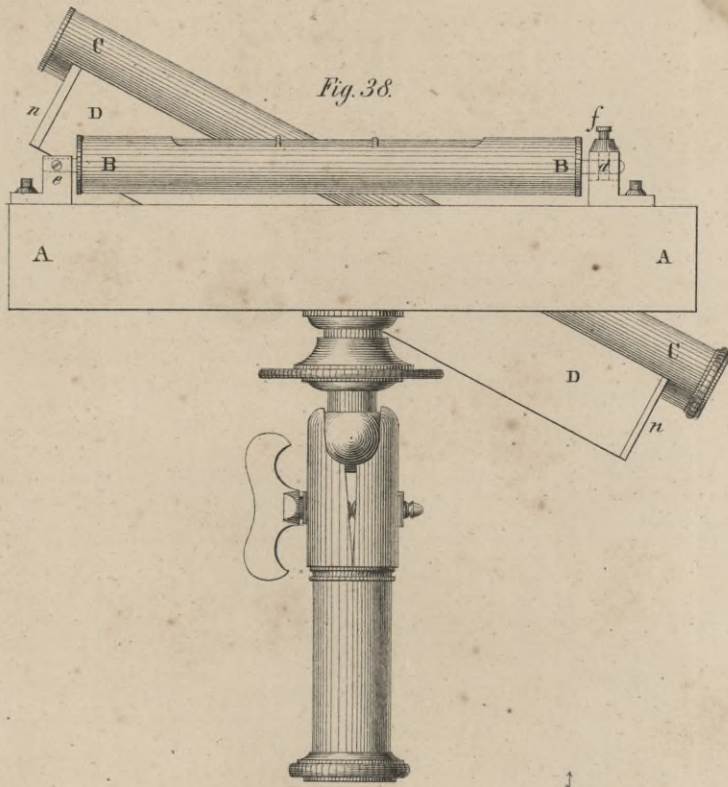


Fig. 38.

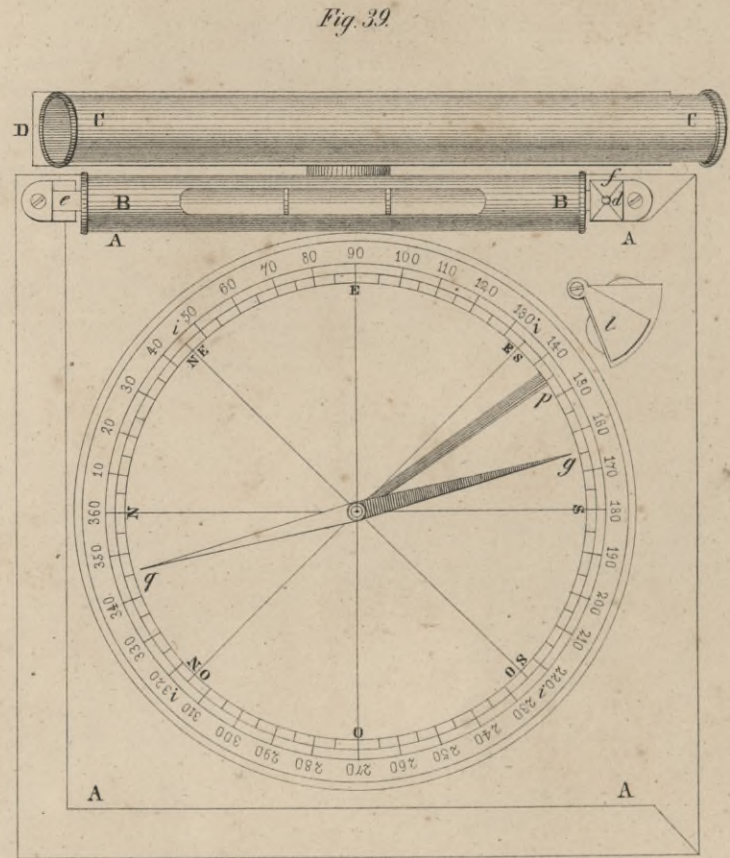


Fig. 39.

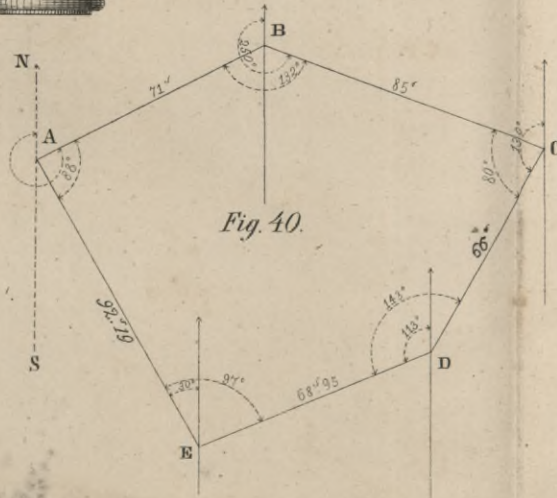


Fig. 40.





Stółik mierniczy
Elewacya

Fig. 41.

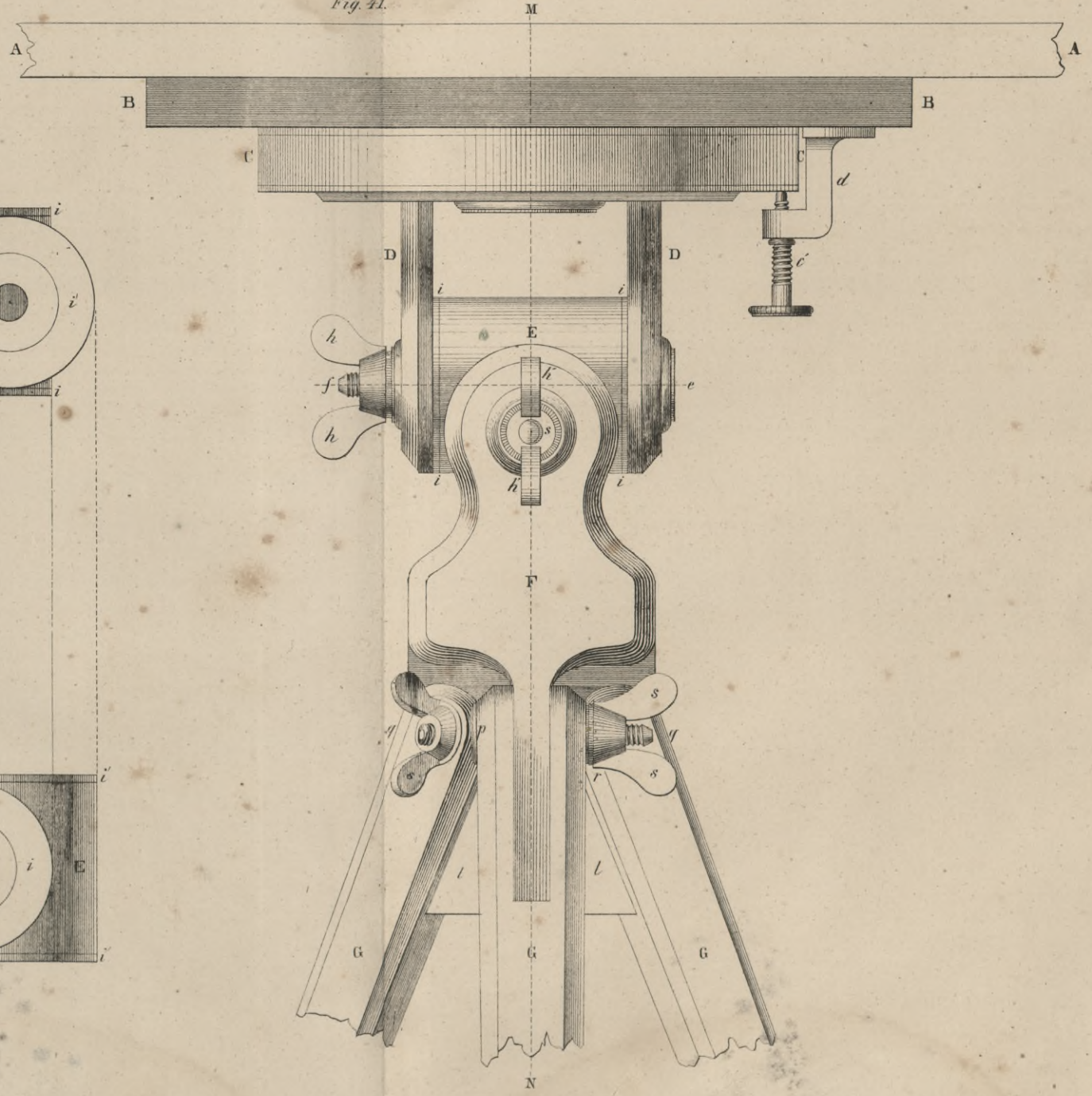
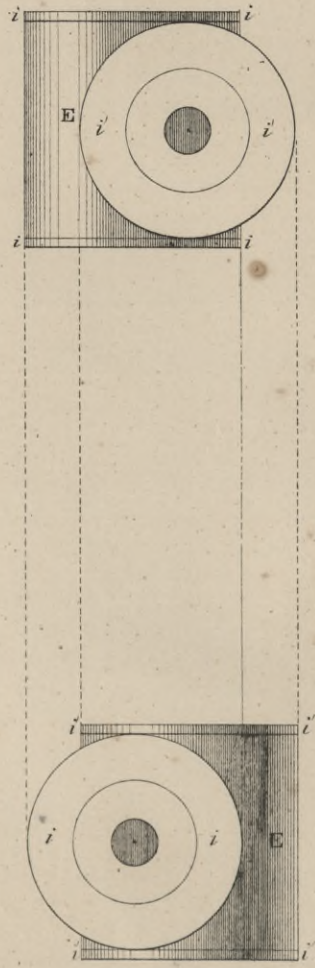


Fig. 43.







Celownica

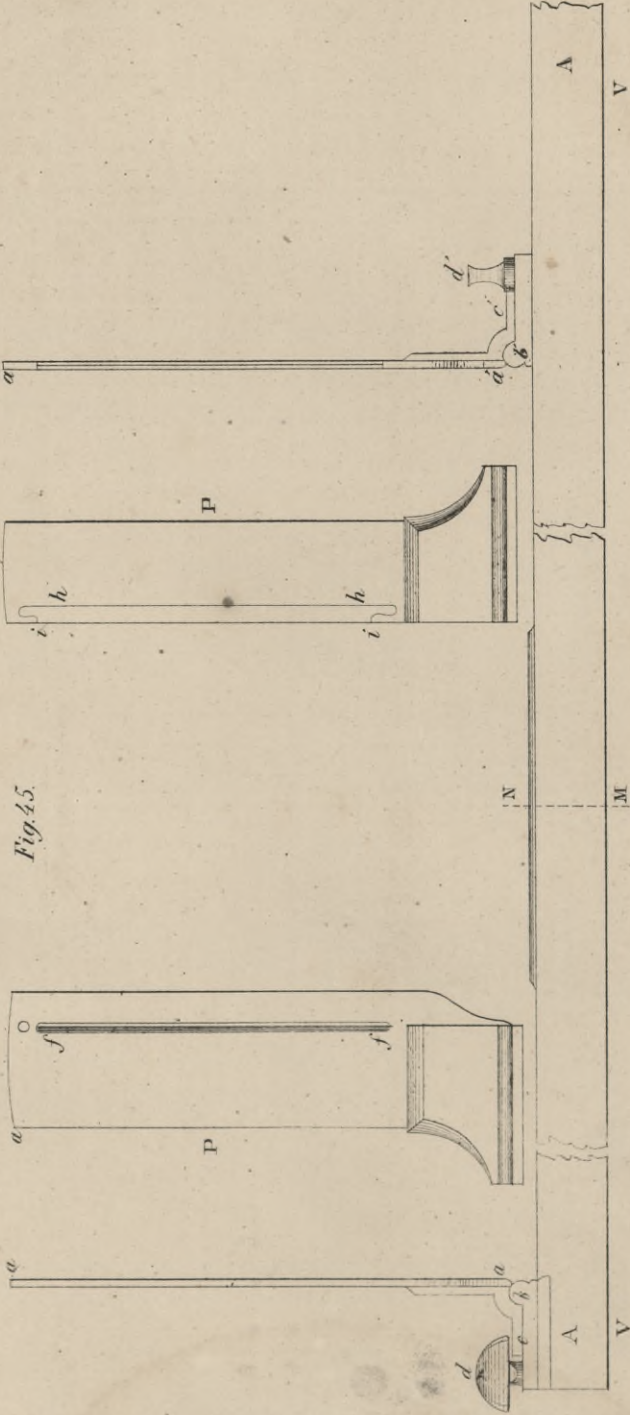


Fig. 45.

Fig. 46.

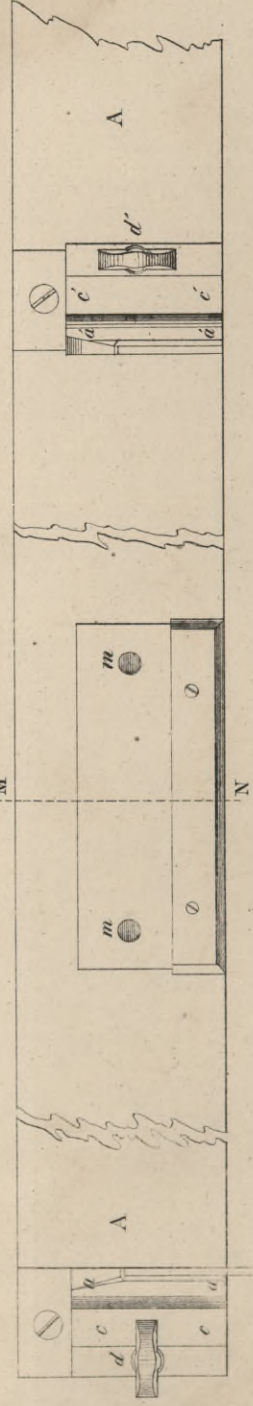
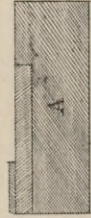


Fig. 47.

Fig. 48.

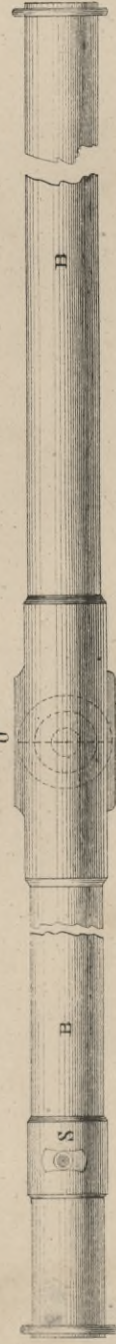
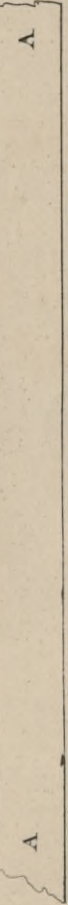
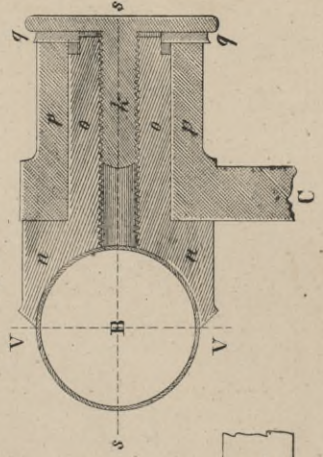


Fig. 49.



Deklinatorium
Plan Fig. 50.

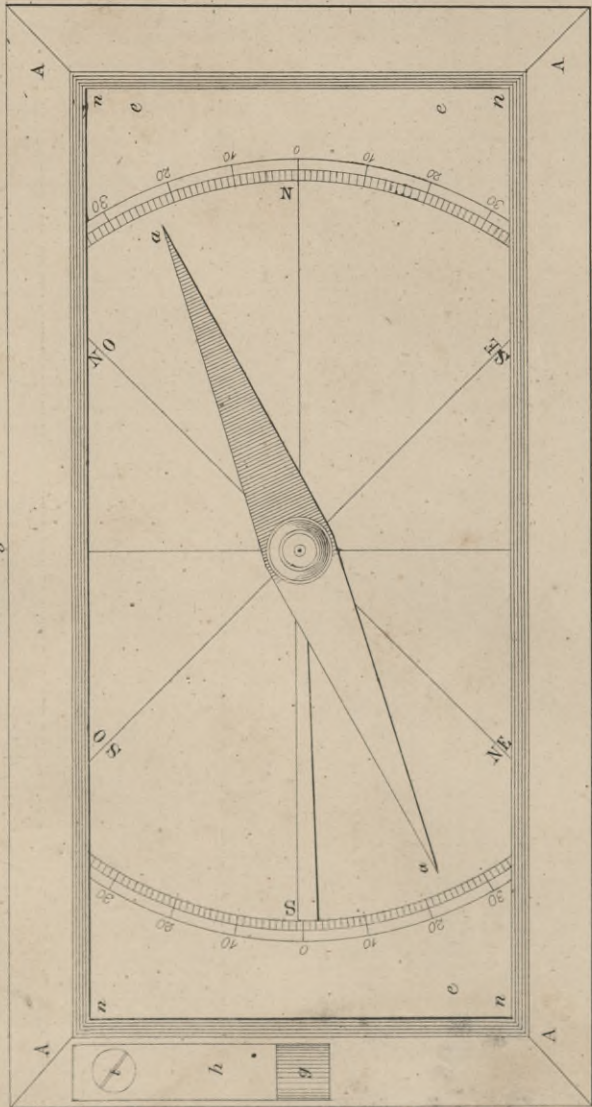


Fig. 58.

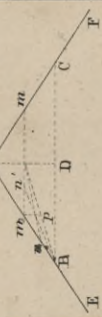
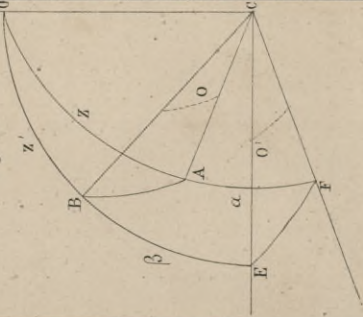


Fig. 60.



Przecięcie podłużne.

Fig. 51.

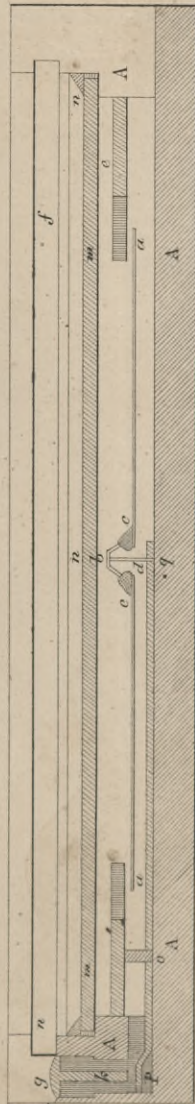


Fig. 61.

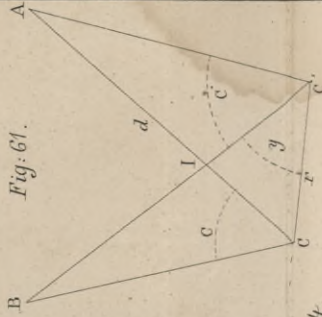


Fig. 53.

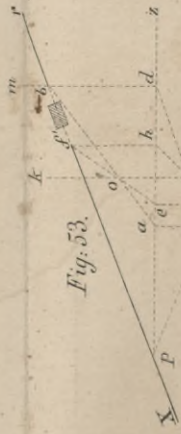


Fig. 52.



Fig. 55.

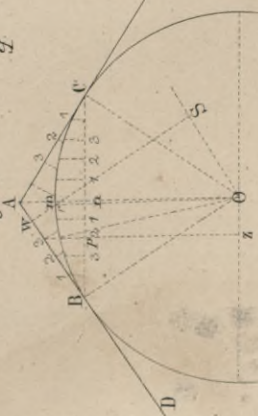


Fig. 56.

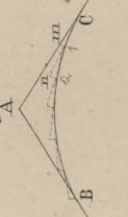


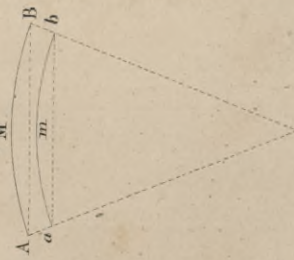
Fig. 57.



Fig. 54.



Fig. 59.



Łata użyta przy mierzaniu południka paryżkiego.

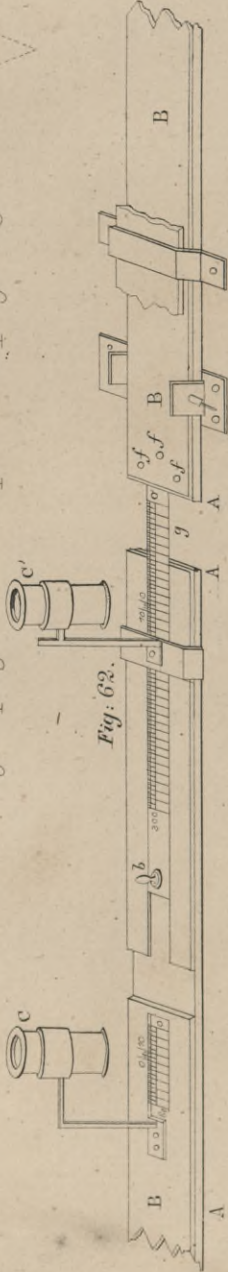
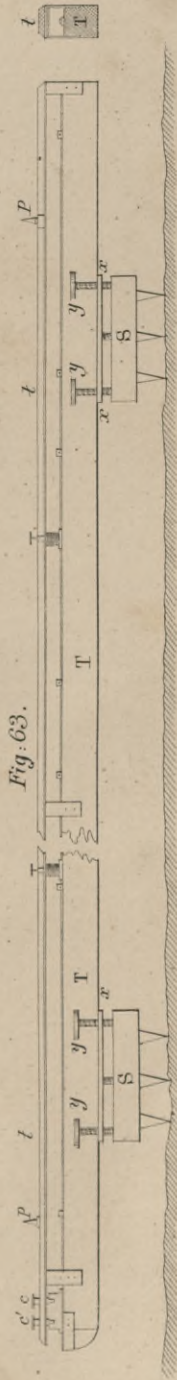


Fig. 63.





Tablica X.

Łata pomysku P Porro.

Elewacja łaty.

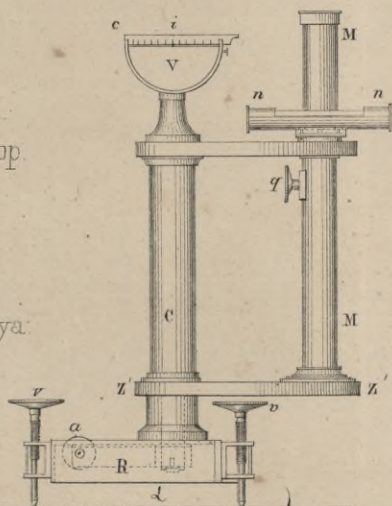
Fig. 64.



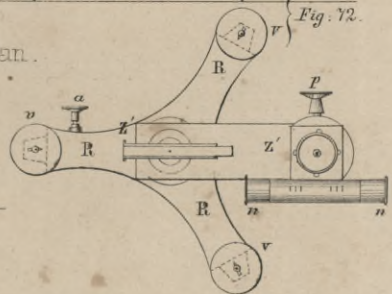
Część środkowa, na której wspiera się libella.
Elewacja.

Mikroskop

Elewacja

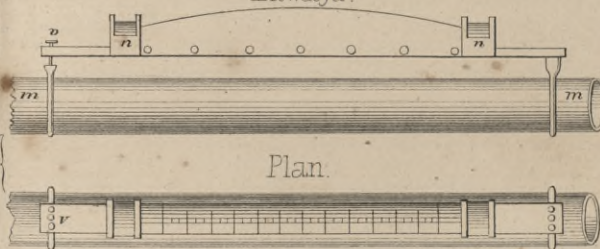


Plan



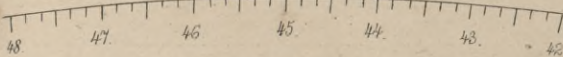
Przecięcie

Fig. 67



Plan

Podziałka wrytana rurce.
Fig. 68.

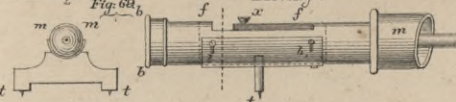


Koniec łaty.

Przecięcie

Fig. 62

Elewacja



Antaba.
Fig. 70.

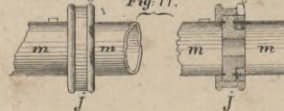


Obrączka na składach.

Elewacja

Fig. 71.

Przecięcie

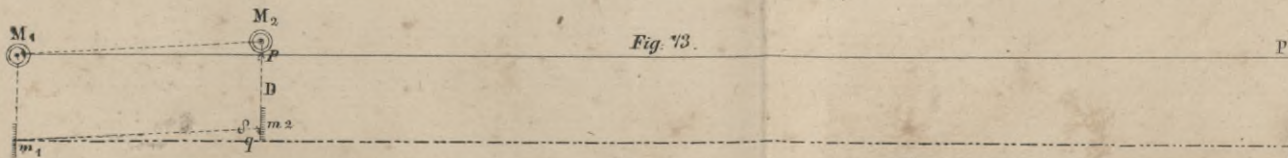


Tablica górna.

Fig. 65.

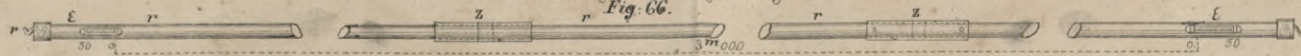


Fig. 73.



Plan części wewnętrznej.

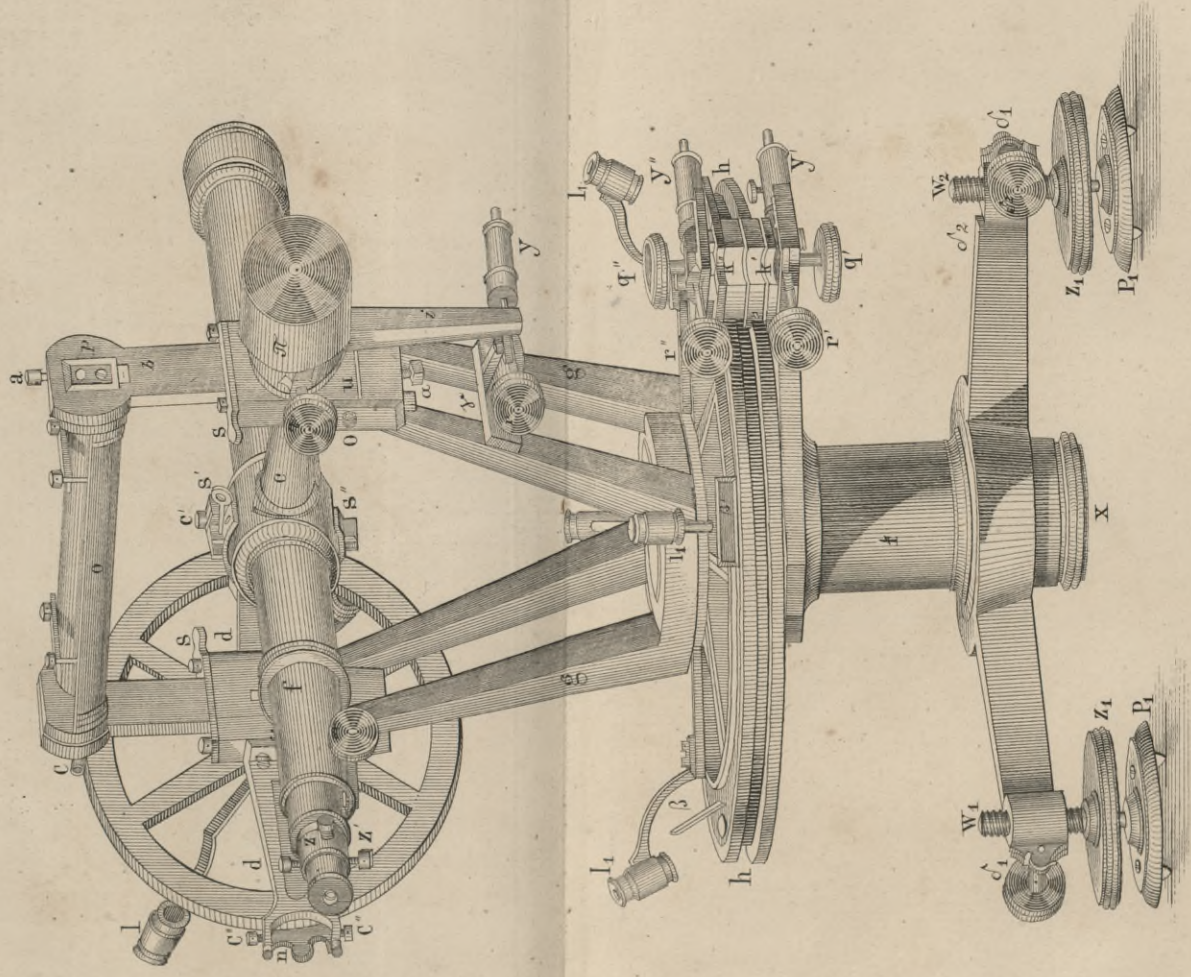
Fig. 66.







Teodolit Ertla.
Elewacya.
Fig. 15.







Przecięcie pionowe
Fig. 76.

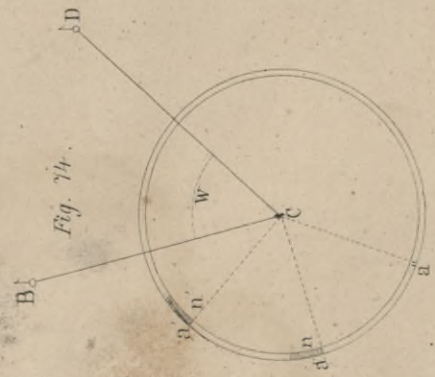
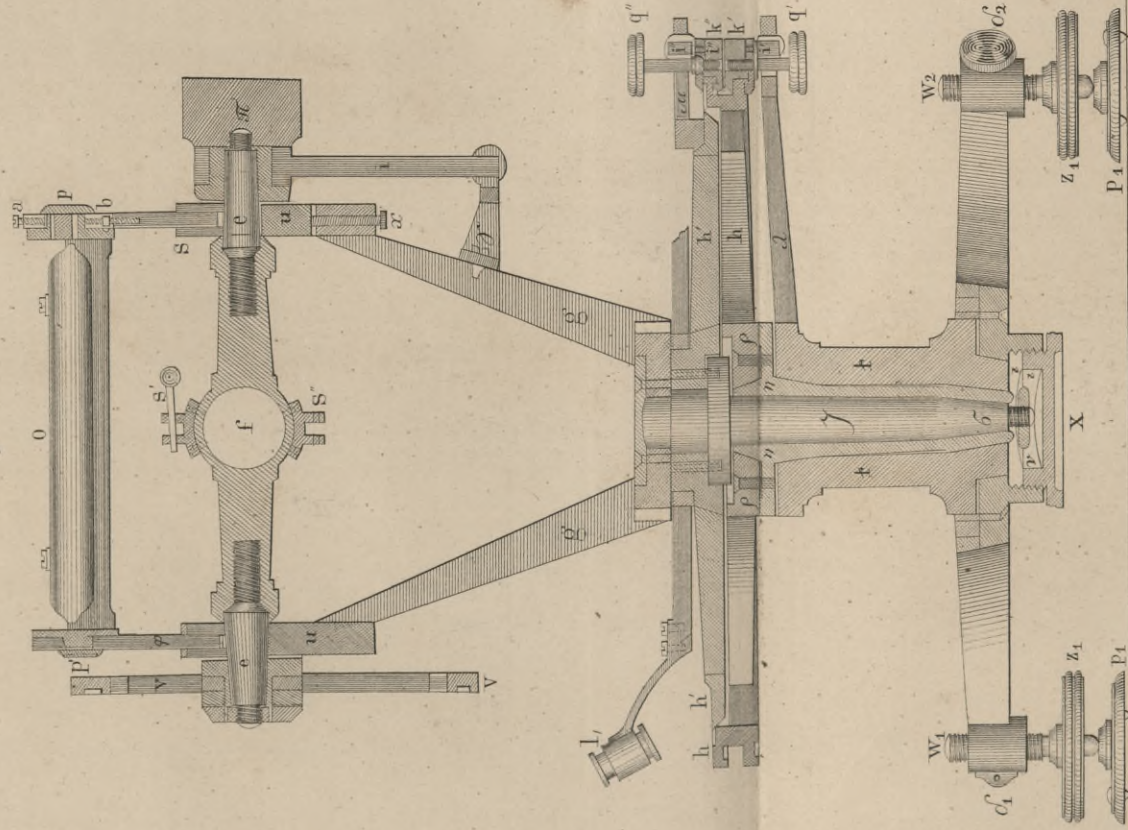
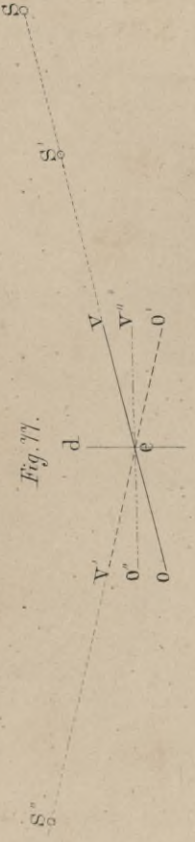
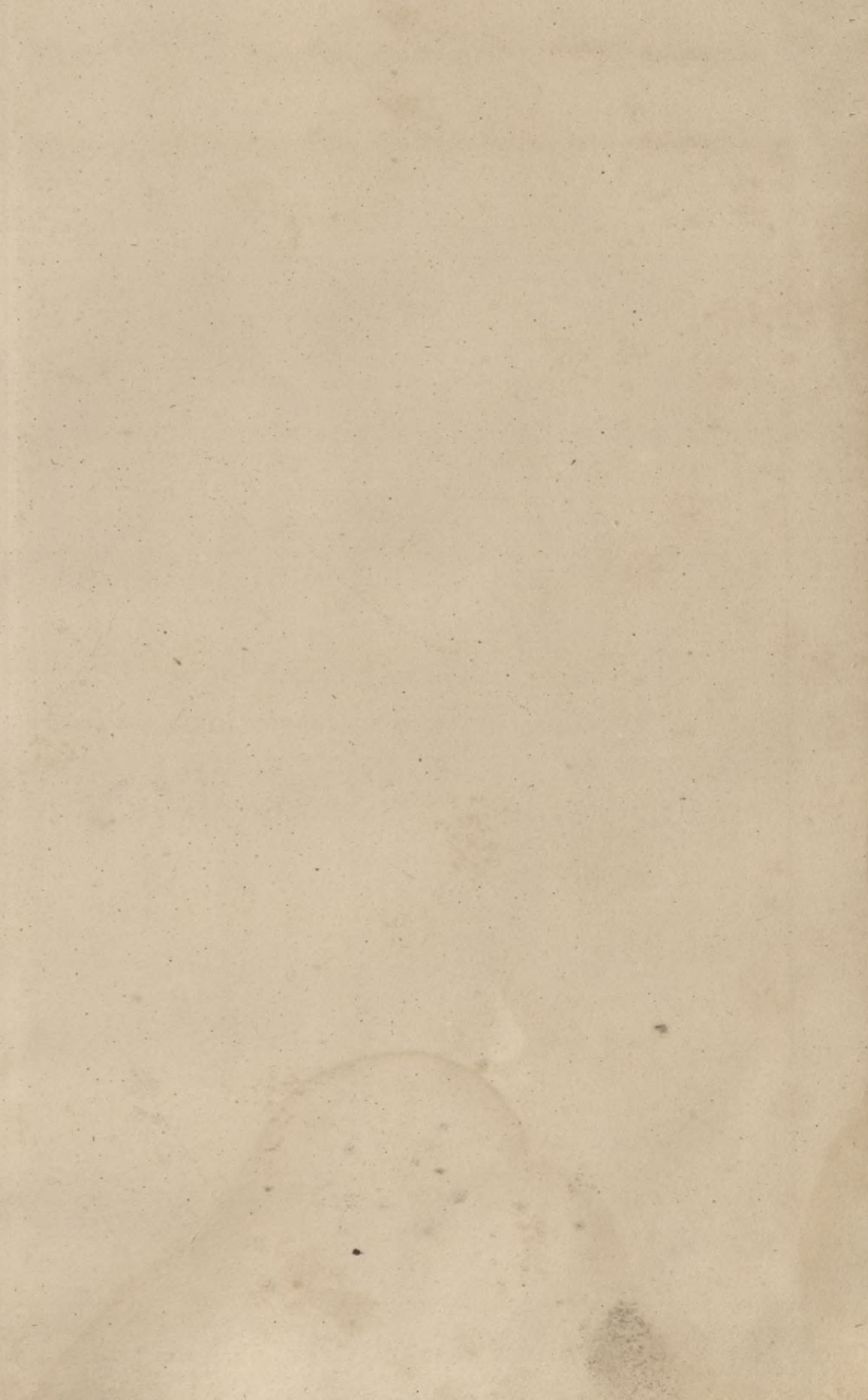


Fig. 77.





Teodolit francuzki uproszony.

Elewacya.

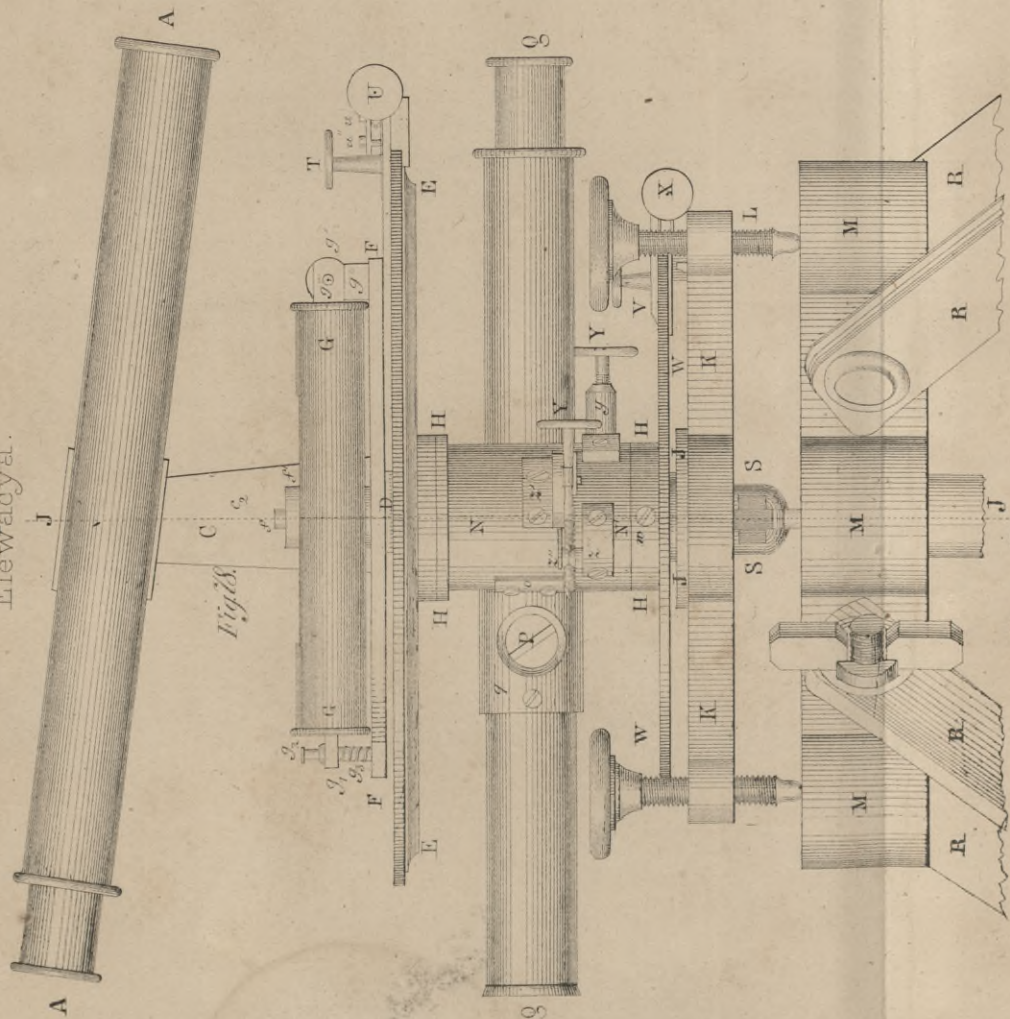
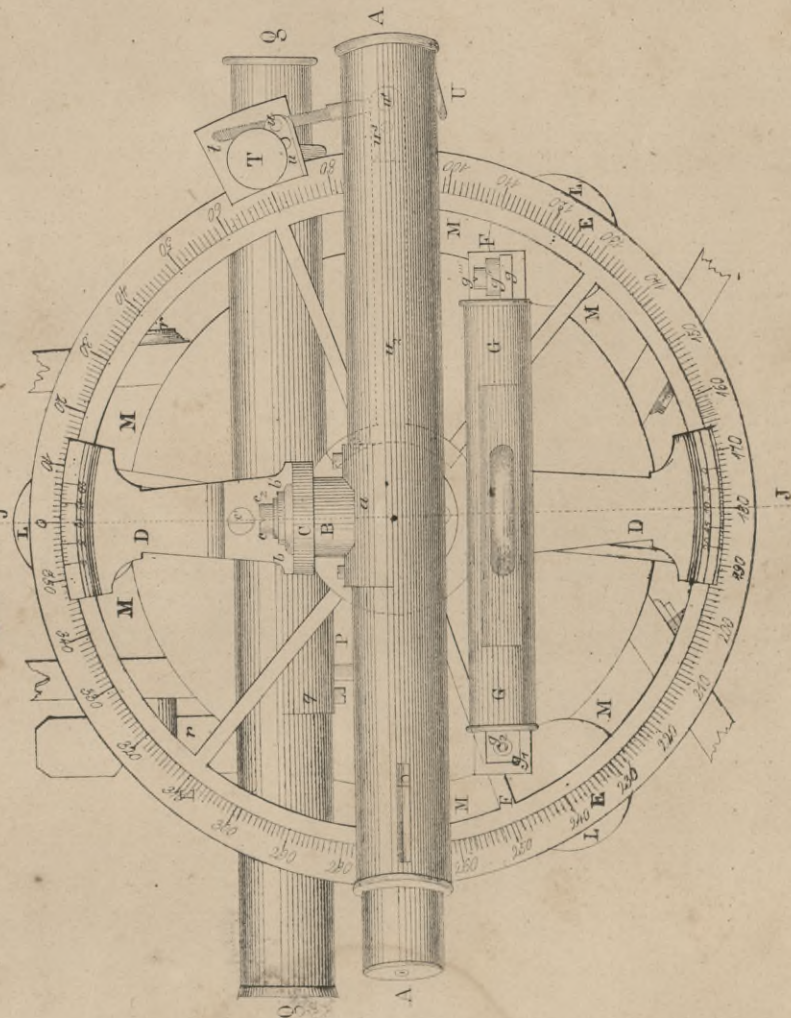
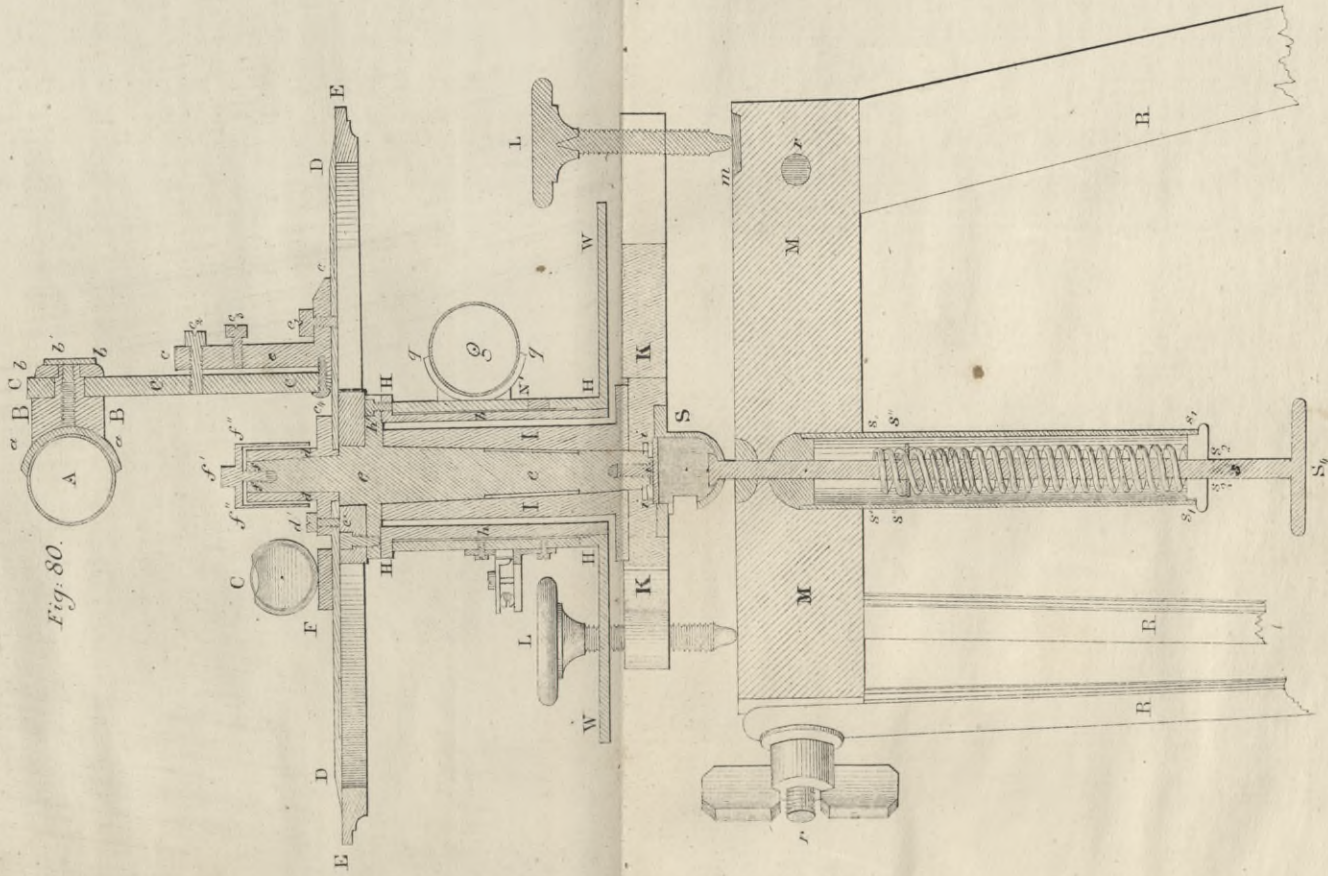


Fig. 13. Plan.



Przecięcie pionowe podług linii JJ.



Narzędzie niwelacyjne Rochette'a

Fig. 85.

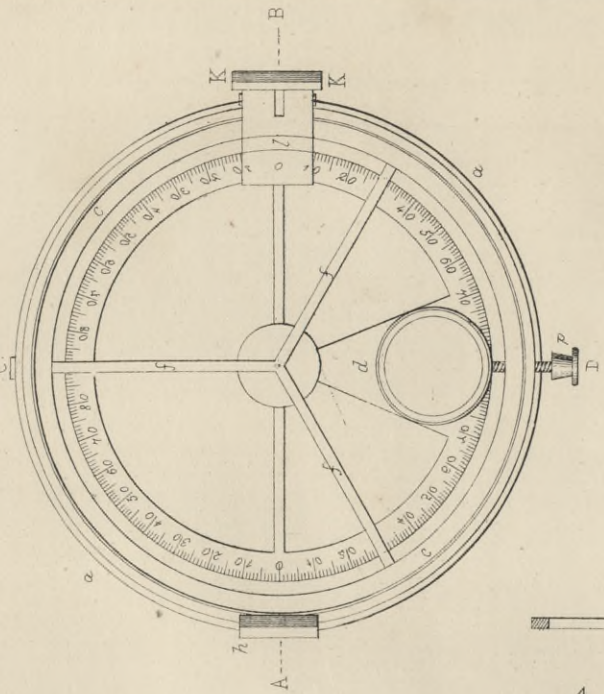
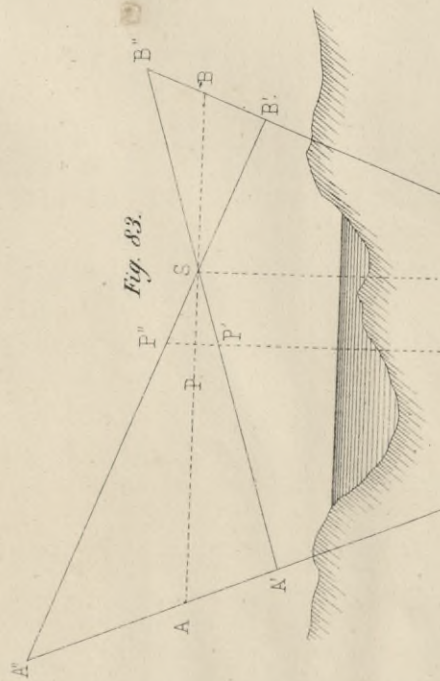
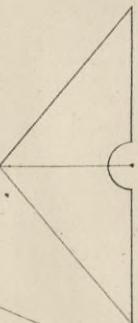


Fig. 83.



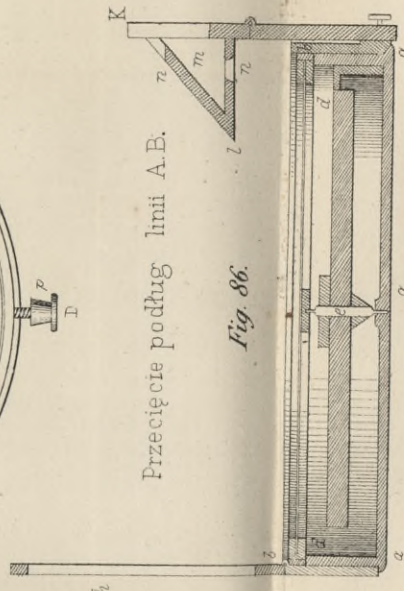
Grundwaga miłarska

Fig. 84.



Przecięcie podług linii A.B.

Fig. 86.



Przecięcie podług linii C.D.

Fig. 87.

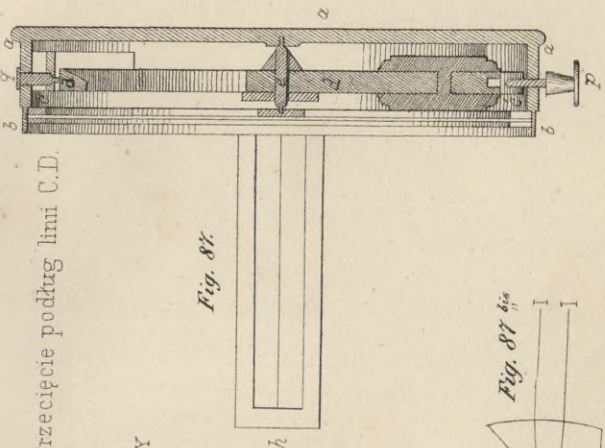


Fig. 82.



Fig. 81.

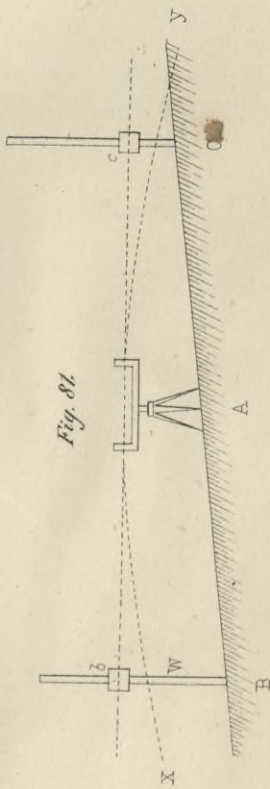
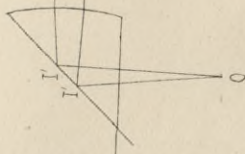


Fig. 87^{1/2}



Grundwaga wodna

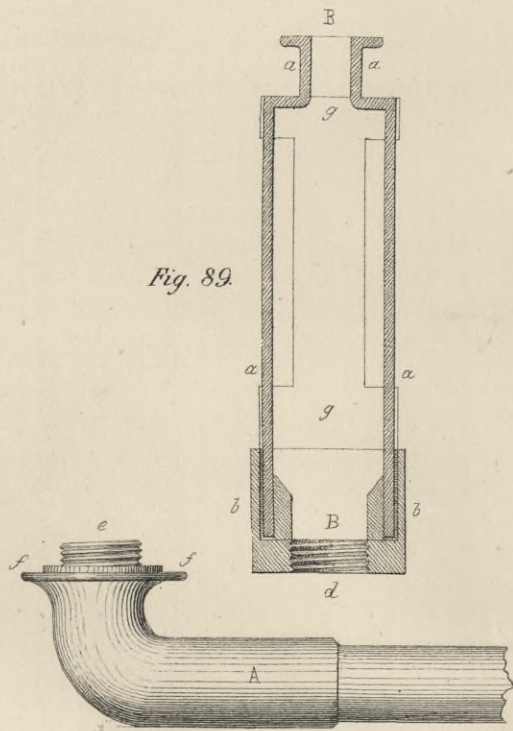


Fig. 89.

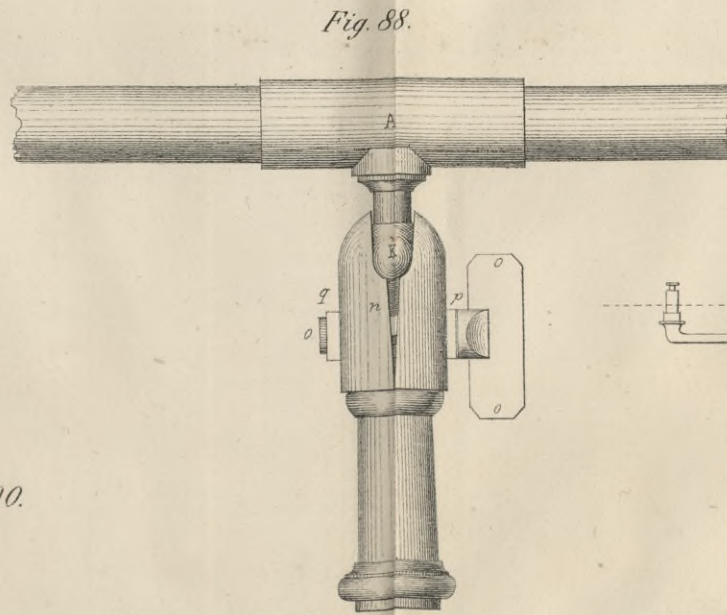


Fig. 88.

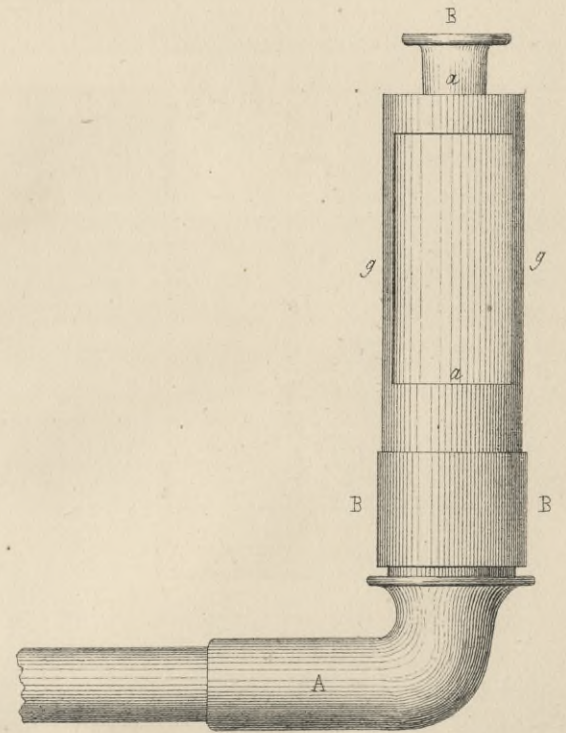


Fig. 90. ^{1/2}

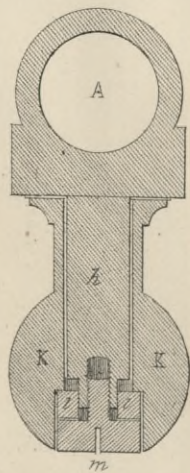


Fig. 90.

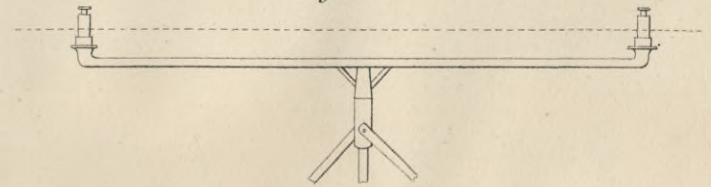
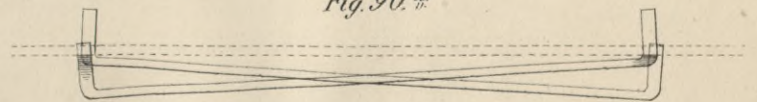
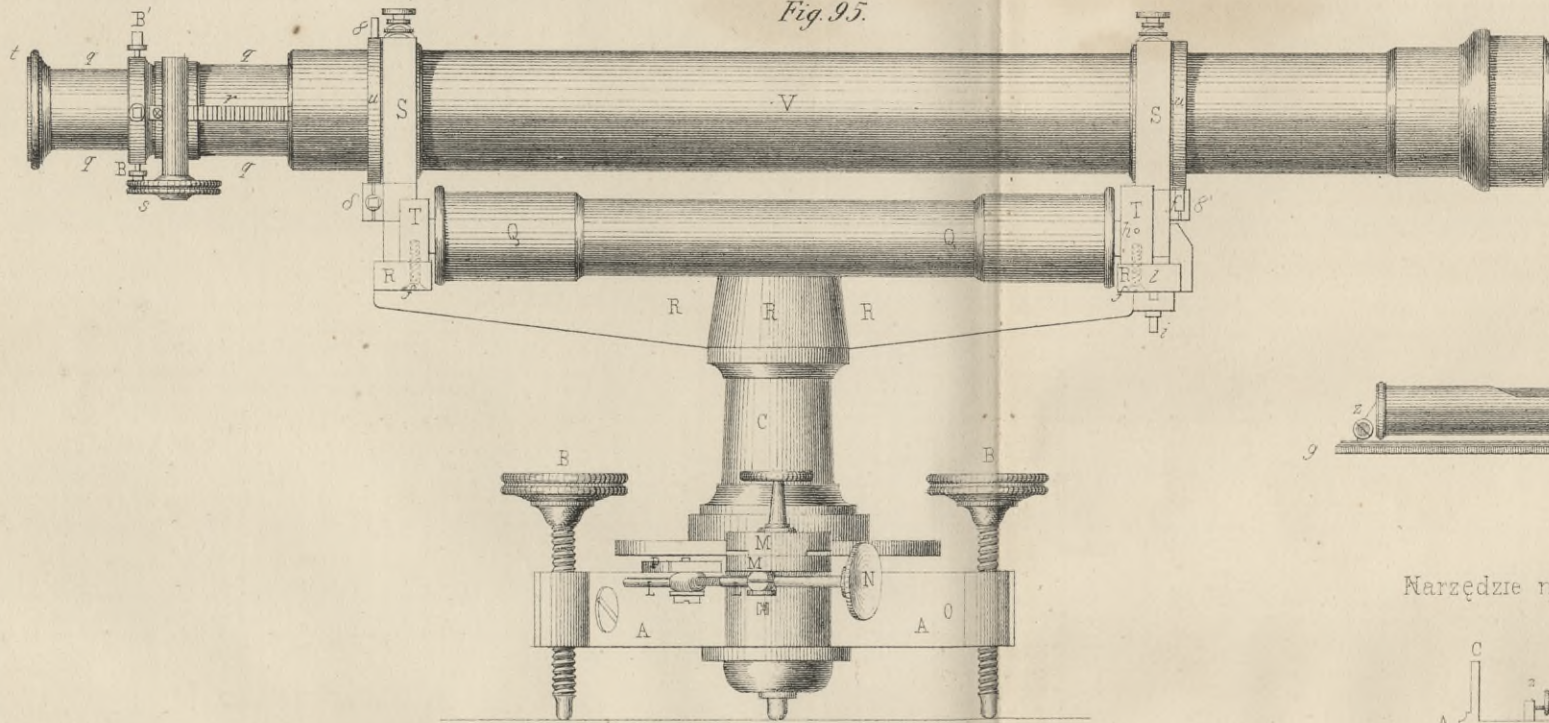


Fig. 90. ^{1/2}



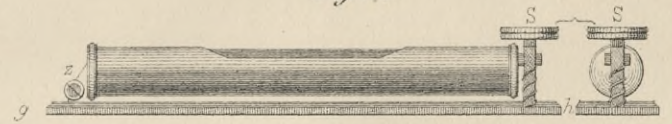
Narzędzie niwellacyjne Egaulta

Fig. 95.



Libella

Fig. 92.



Narzędzie niwellacyjne z celownikami i libella

Fig. 94.

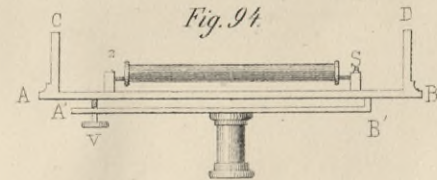


Fig. 93.

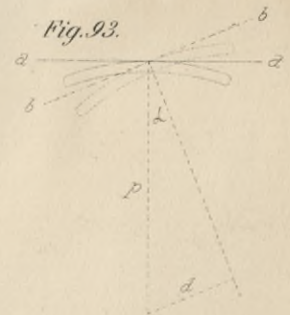


Fig. 96.

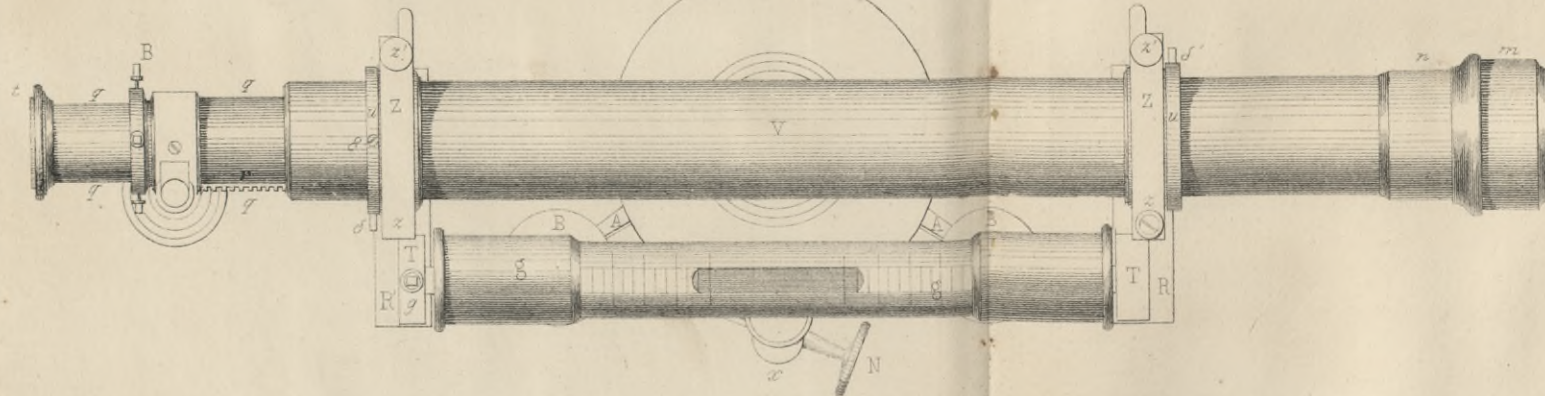




Fig. 99.

Fig. 100.

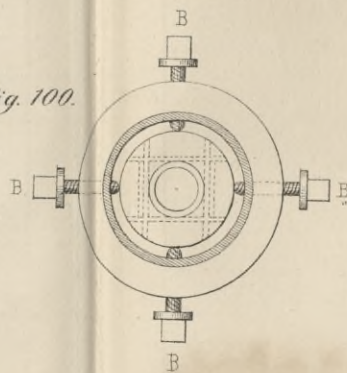
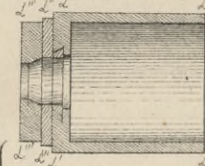


Fig. 101.

Przecięcie bębena pionowe



Przecięcie bębena poziome

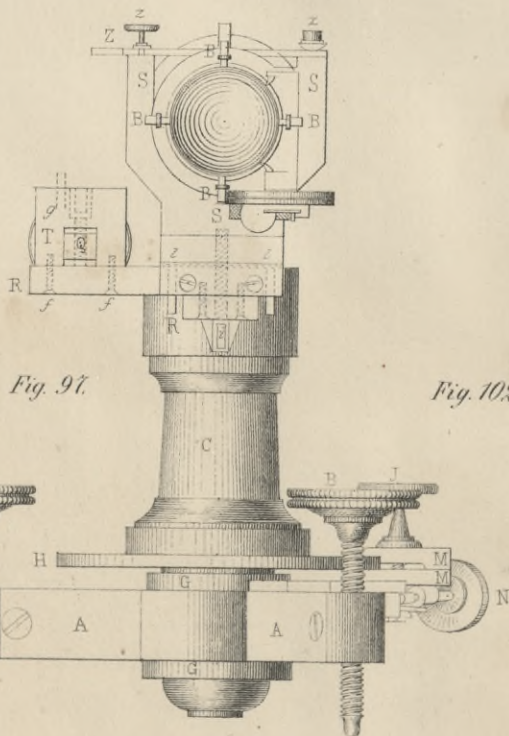
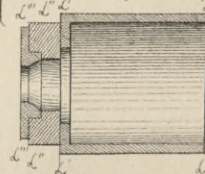


Fig. 97.

Fig. 102.

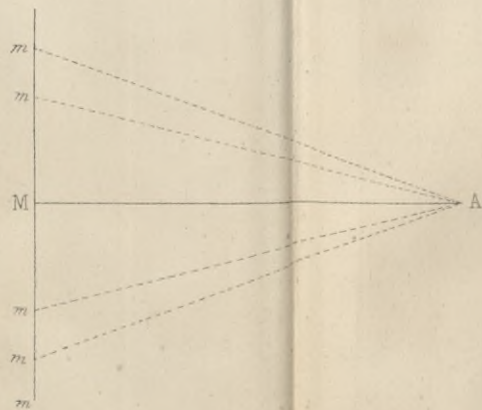
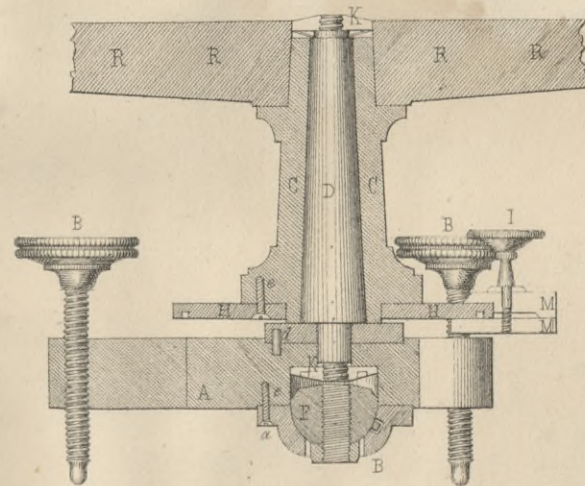


Fig. 98.





Narzędzie nivellacyjne Lencira.

Fig. 103.

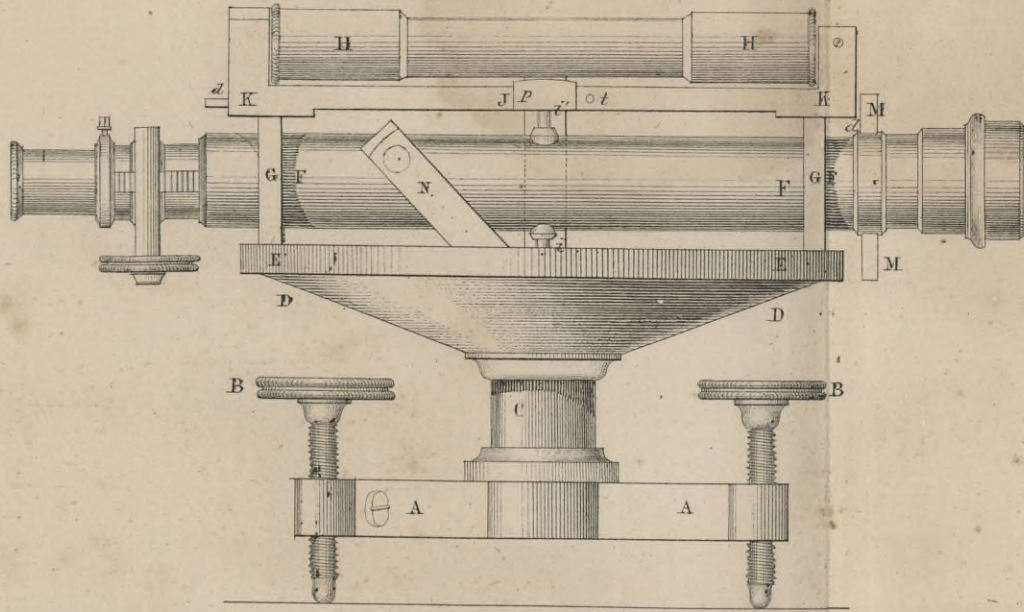


Fig. 104

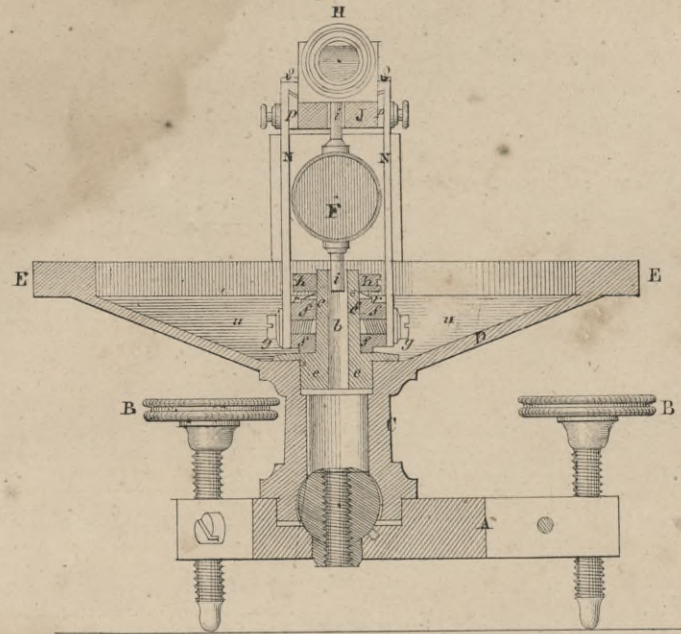


Fig. 105.

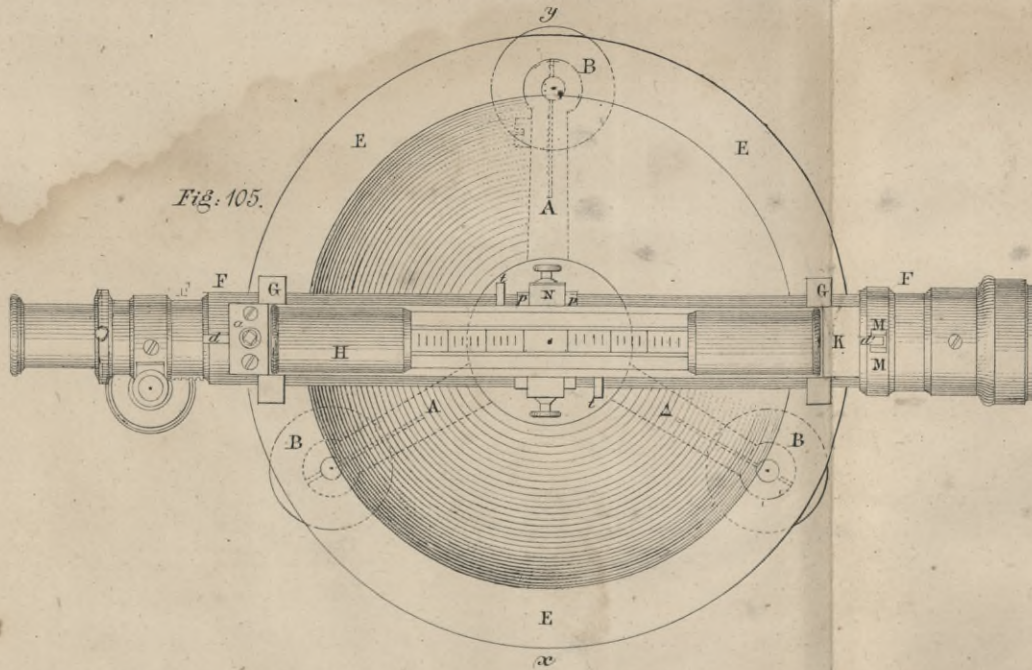
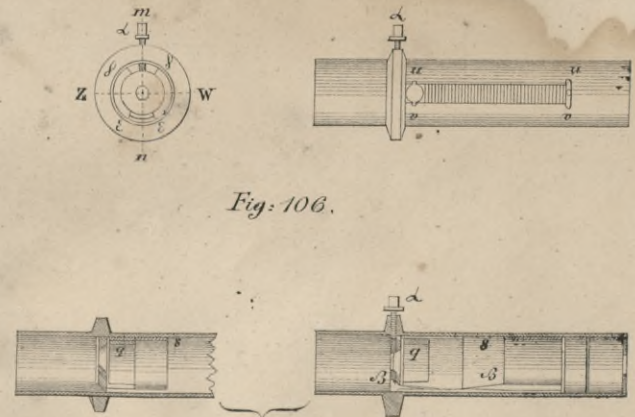
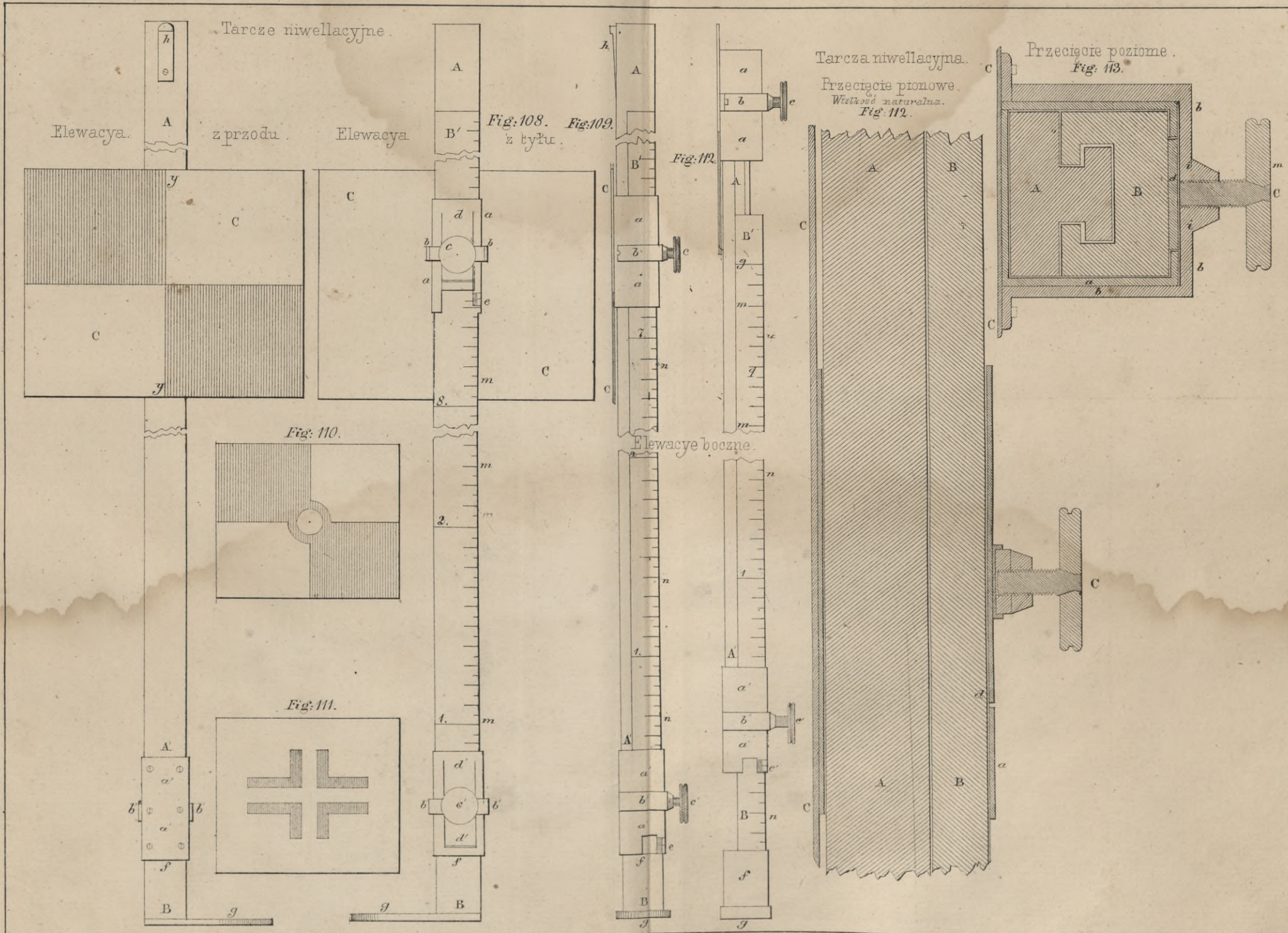


Fig. 106.





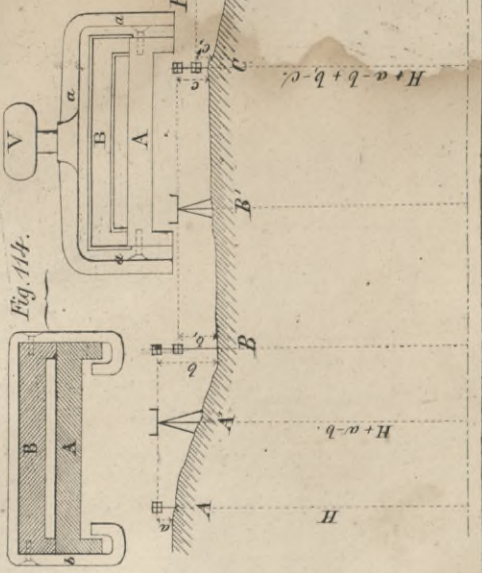
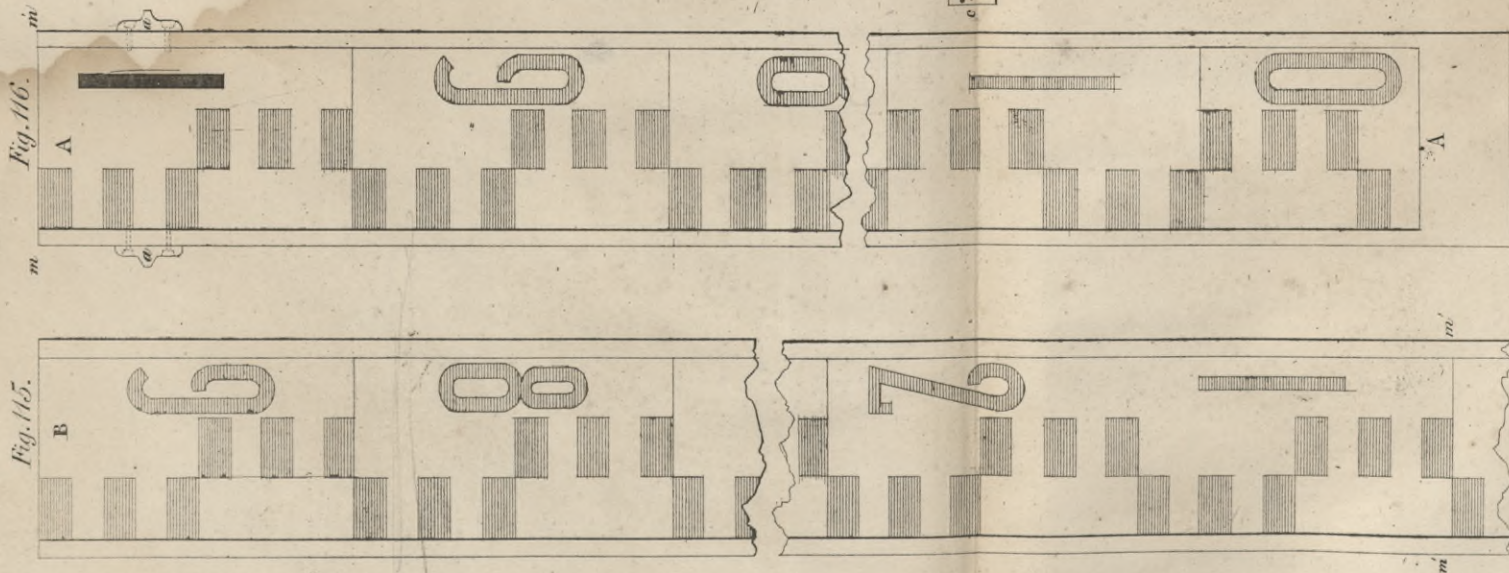
Tablica XX.





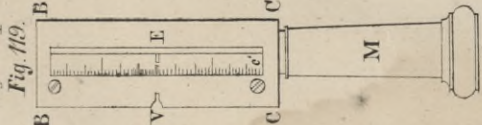


Łata niwelacyjna.

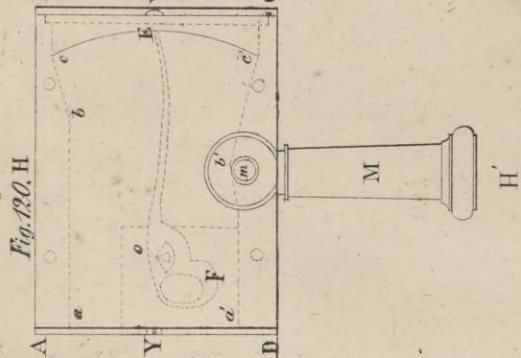


Spadkomierz Burnieya.

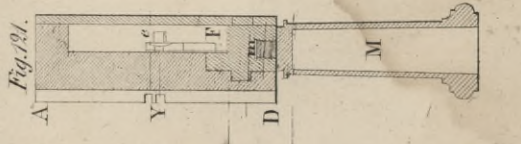
Elewacya przodu.



Elewacya boczna.

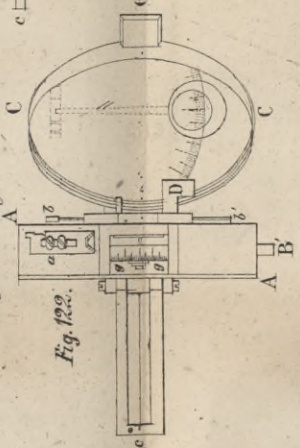


Przestępnop lini H H.

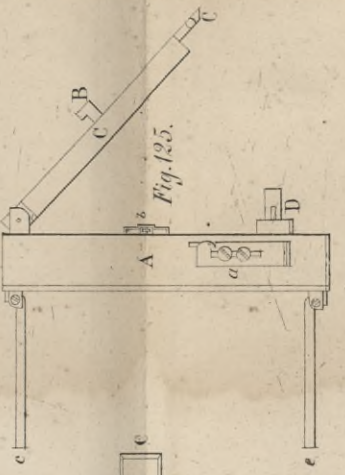


Spadkomierz z busolą..

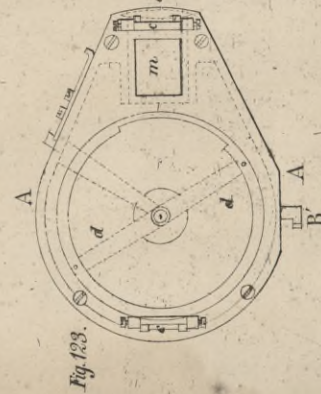
Elewacya.
Narzędzie ustawiemo do mierzenia
odległości unitowych.



Busolna płaszczyznę równoległą do
płaszczyzny celu.



Plan.



Tuleja

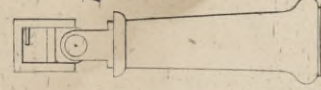
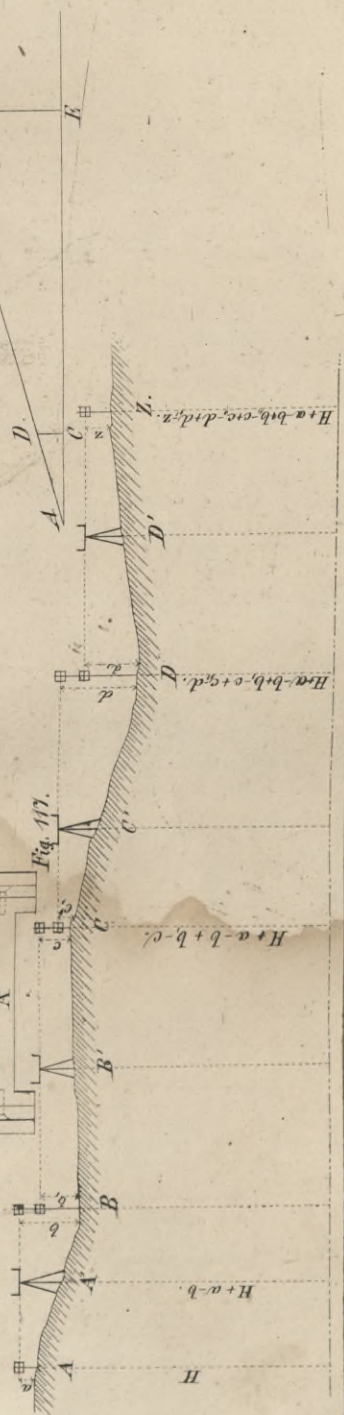
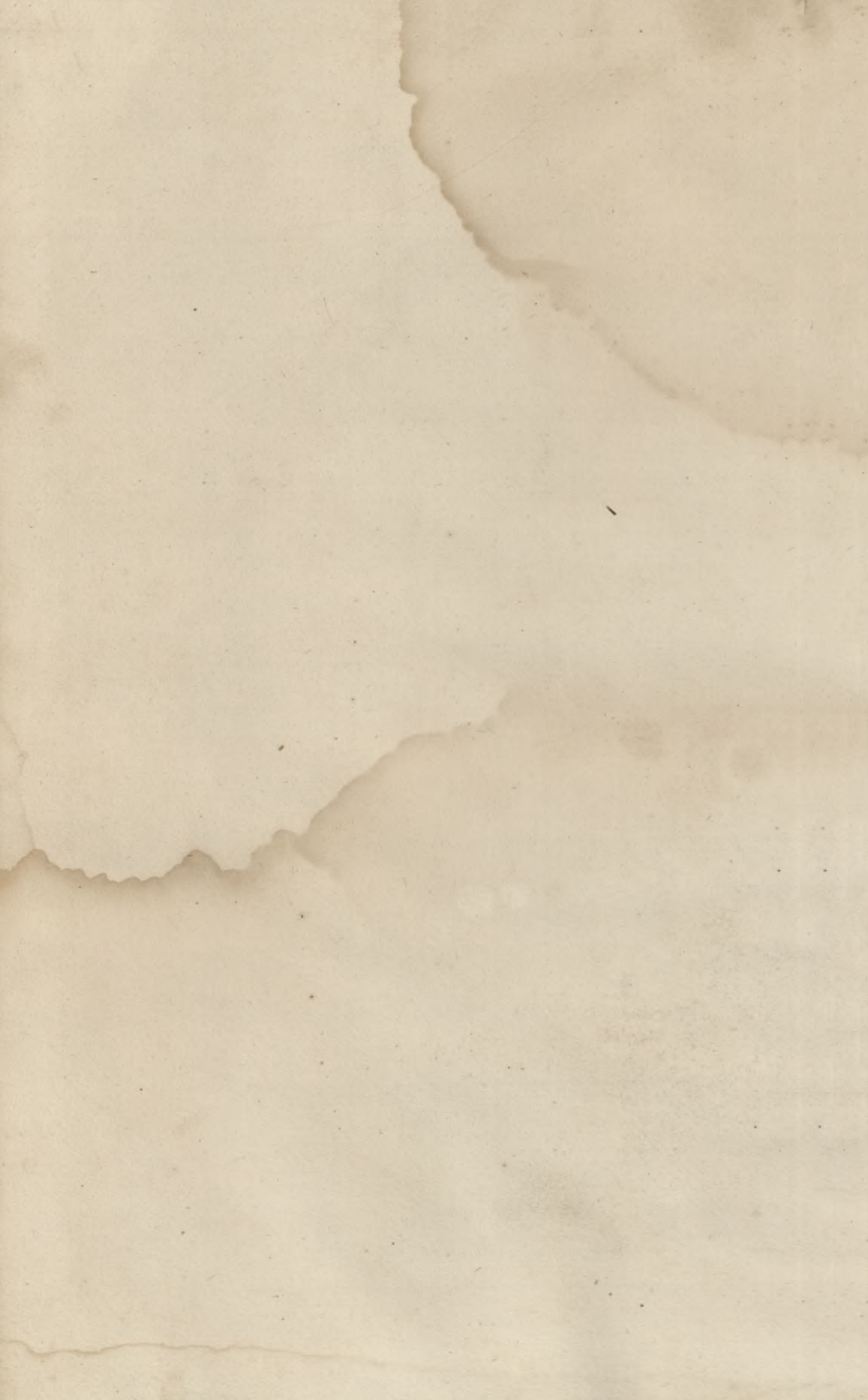


Fig. 118.





Spadkomierz P. Chezy.

Elewacya.



Celownik stary.

Fig. 126.

Celownik ruchomy.

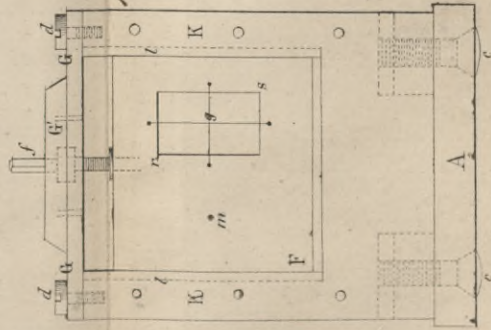
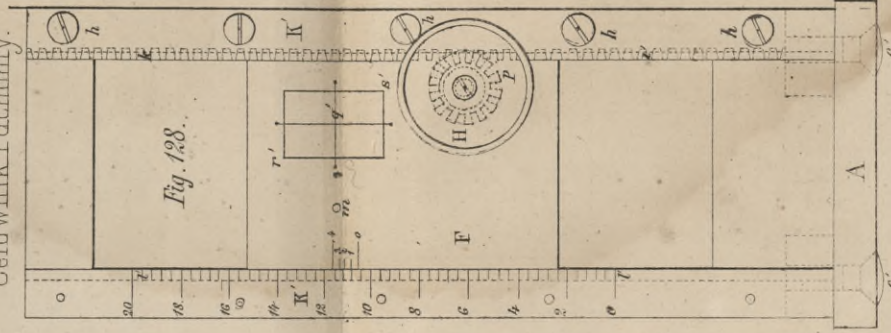
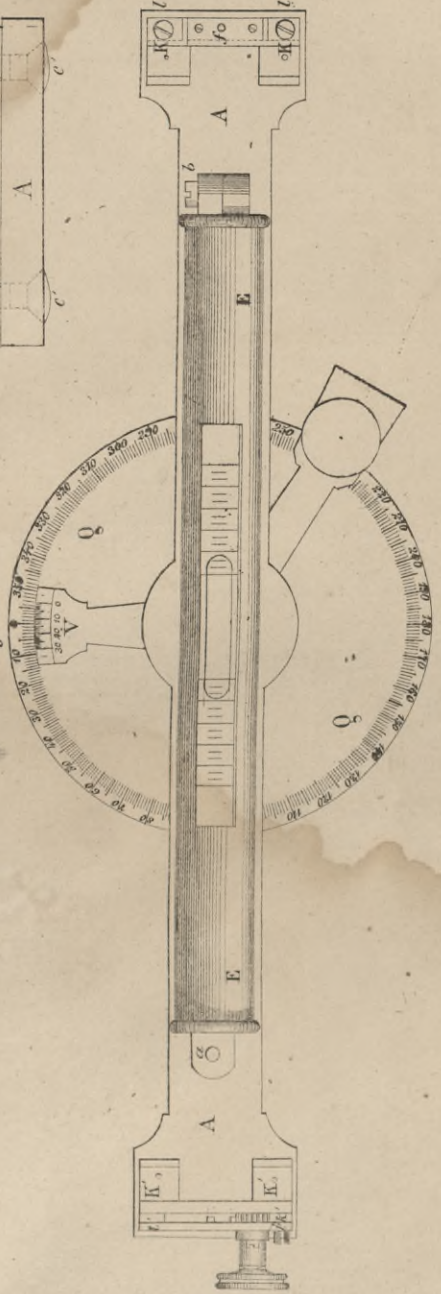


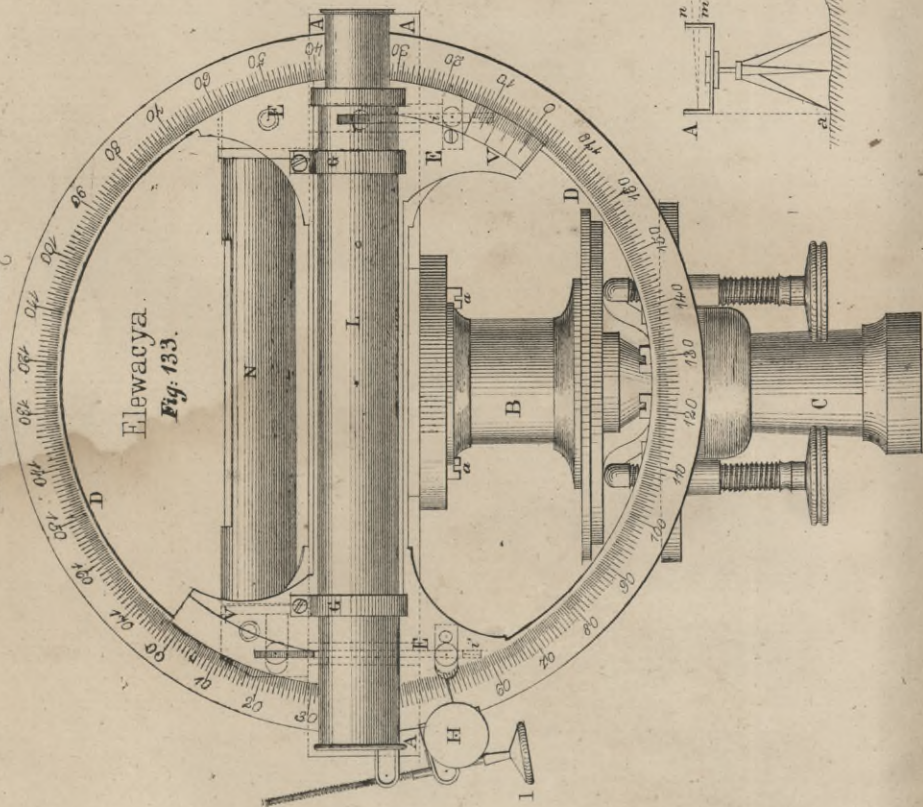
Fig. 129.

Plan.

Fig. 127.



Eklimetr z busolą



Elewacya.
Fig. 133.

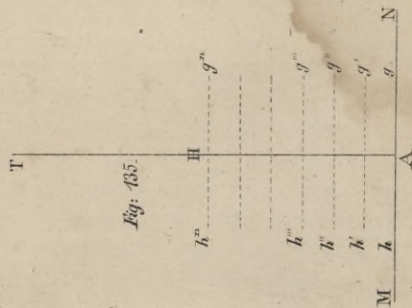


Fig. 135.

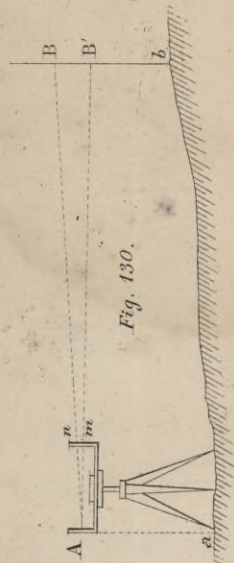


Fig. 130.

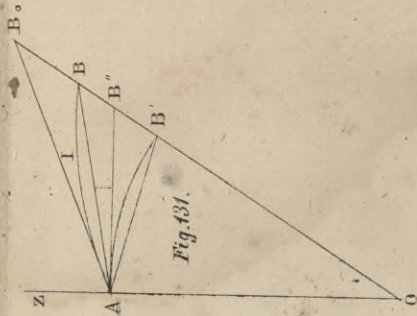


Fig. 131.

Plan.

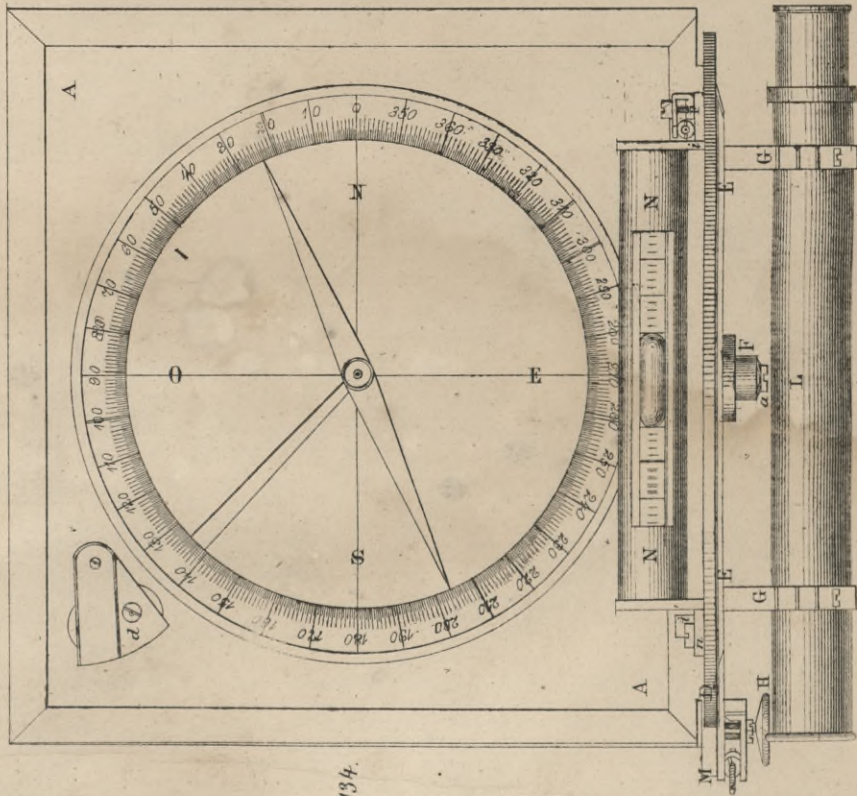


Fig. 134.

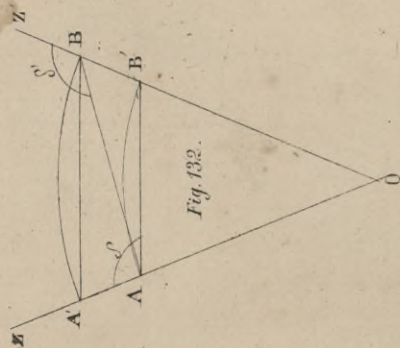


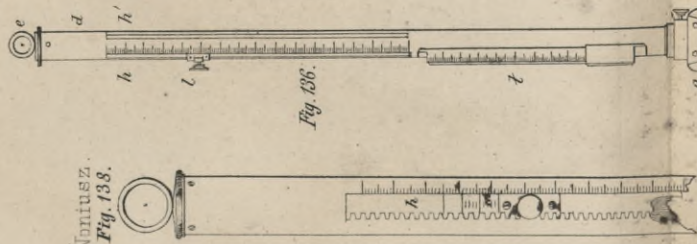
Fig. 132.





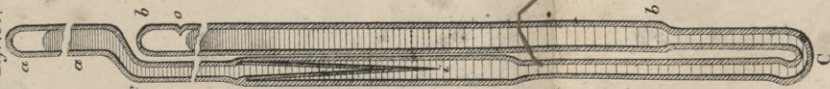
Barometr Gay Lussac'a.

Elewacya.



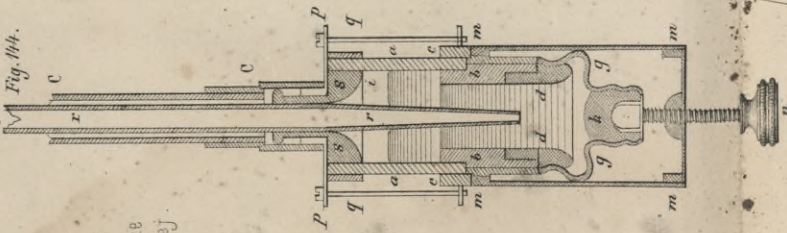
Nontusz.
Fig. 138.

Przecięcie podłużne
rurki barometrycznej.
Fig. 131.



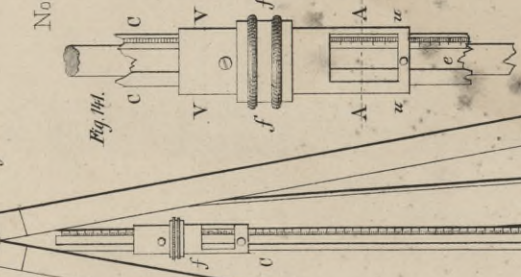
Barometr

Przecięcie podłużne
naczynia.
Fig. 144.



Fortina.

Elewacya.
Fig. 140.



Nontusz.

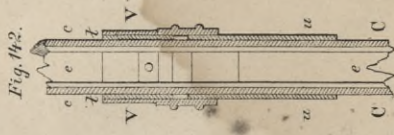
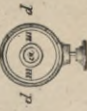


Fig. 142.

Przecięcie poprzeczne AA.
Fig. 143.



Fig. 139.









BIBLIOTEKA GŁÓWNA

Biblioteka Politechniki Krakowskiej



II-352555

PK 330/90 - 100 000

Politechnika Krakowska

Biblioteka Politechniki Krakowskiej



100000313383