



Biblioteka Politechniki Krakowskiej



100000301157

Atlas

Handbuch der Ingenieur-Verfahren

Band II

Der Brückenbau

in seinem ganzen Umfange

von

Dr. August

1880

Atlas

zum

Handbuch der Ingenieur-Wissenschaft

Band II.

Der Brückenbau

in seinem ganzen Umfange

von

Max Becker,

Ober-Baurath bei der Großherzogl. Ober-Direction des Wasser- und Straßenbaues, vormaliger Professor an der technischen Hochschule zu Karlsruhe, Ritter des Großherzogl. badischen Sähringer Löwenordens, des Königl. preuß. Kronordens III. Classe, des Königl. bayerischen Verdienstordens vom 1. Michael, des Königl. Württembergischen Kronordens und des Herzogl. nassauischen Civilverdienstordens Adolf von Nassau.

Vierte verbesserte und vermehrte Auflage.

Neue Ausgabe.

F. Nr. 18460.



Dresden

Verlag von Gerhard Kührtmann

früher Verlag von Baumgärtner's Buchhandlung

LEIPZIG 1882.

III. C. 6.



~~III. 24651~~ IV 201187

BPK- B- 107 / 2019

Akc. Nr.

~~504 / 52~~

Verzeichniß der Tafeln.

- Tafel
- I. Hölzerne und eiserne Brückenjoche — Eisbrecher.
 - II. Verschiedene Pfeilerformen.
 - III. Geländer für Brücken, Gesimse, Gurten und Randalaber.
 - IV. Hölzerne Brücken verschiedener Construction.
 - V. Hölzerne Brücke für größere Spannweiten.
 - VI. Hölzerne Sprengwerk- und Bogenbrücken.
 - VII. Hölzerne Bogenbrücken.
 - VIII. Hölzerne Bogen- und Gitterbrücken.
 - IX. Hölzerne Brücken nach amerikanischem System.
 - X. Hölzerne Brücken nach dem System von Howe.
 - XI. Steinerne Brücken und Viaducte.
 - XII. Widerlager steinerner Brücken.
 - XIII. Steinerne Brücke bei Cannstatt über den Neckar.
 - XIV. Steinerne Brücke über die Aar in Bern.
 - XV. Theoretische Figuren.
 - XVI. Gußeiserne Barrenbrücken.
 - XVII. Gußeiserne Hängwerkbrücken.
 - XVIII. Gußeiserne Bogenbrücken.
 - XIX. Röhrenbrücken nach dem System von Reichenbach und Polonceau.
 - XX. Schmiedeeiserne Brücken verschiedener Systeme.
 - XX.a Schmiedeeiserne Eisenbahnbrücken für kleinere Spannweiten.
 - XX.b Schmiedeeiserne Blechbrücken nach den Systemen von Fairbairn und Stephenson.

- Tafel
- XX.c Schmiedeeiserne Gitterbrücken.
 - XXI. Schmiedeeiserne Gitterbrücke bei Offenburg im Großherzogthum Baden.
 - XXI.a Eisenbahnviaduct bei Freiburg in der Schweiz.
 - XXII. Schmiedeeiserne Fachwerkbrücke — Rheinbrücke zwischen Mannheim und Ludwigshafen.
 - XXII.a Details dazu.
 - XXIII. Schmiedeeiserne Bogenhängwerkbrücke von Schwedler.
 - XXIII.a Details dazu.
 - XXIV. Schmiedeeiserne Brücke nach dem System Pauli.
 - XXV. Schmiedeeiserne Bogenbrücke bei Mülheim von Hartwich.
 - XXV.a Details hierzu.
 - XXVI. Schmiedeeiserne Brücken nach amerikanischem System.
 - XXVI.a Theoretische Figuren.
 - XXVI.b " " " "
 - XXVII. Bewegliche Brücken verschiedener Art.
 - XXVIII. Drehbrücken.
 - XXIX. Schiffbrücken.
 - XXX. Kettenbrücke in Prag.
 - XXXI. Details dazu.
 - XXXII. Drahtbrücken.
 - XXXIII. Bandbrücken.
 - XXXIV. Militärische Brückensysteme.
 - XXXV. Theoretische Figuren.

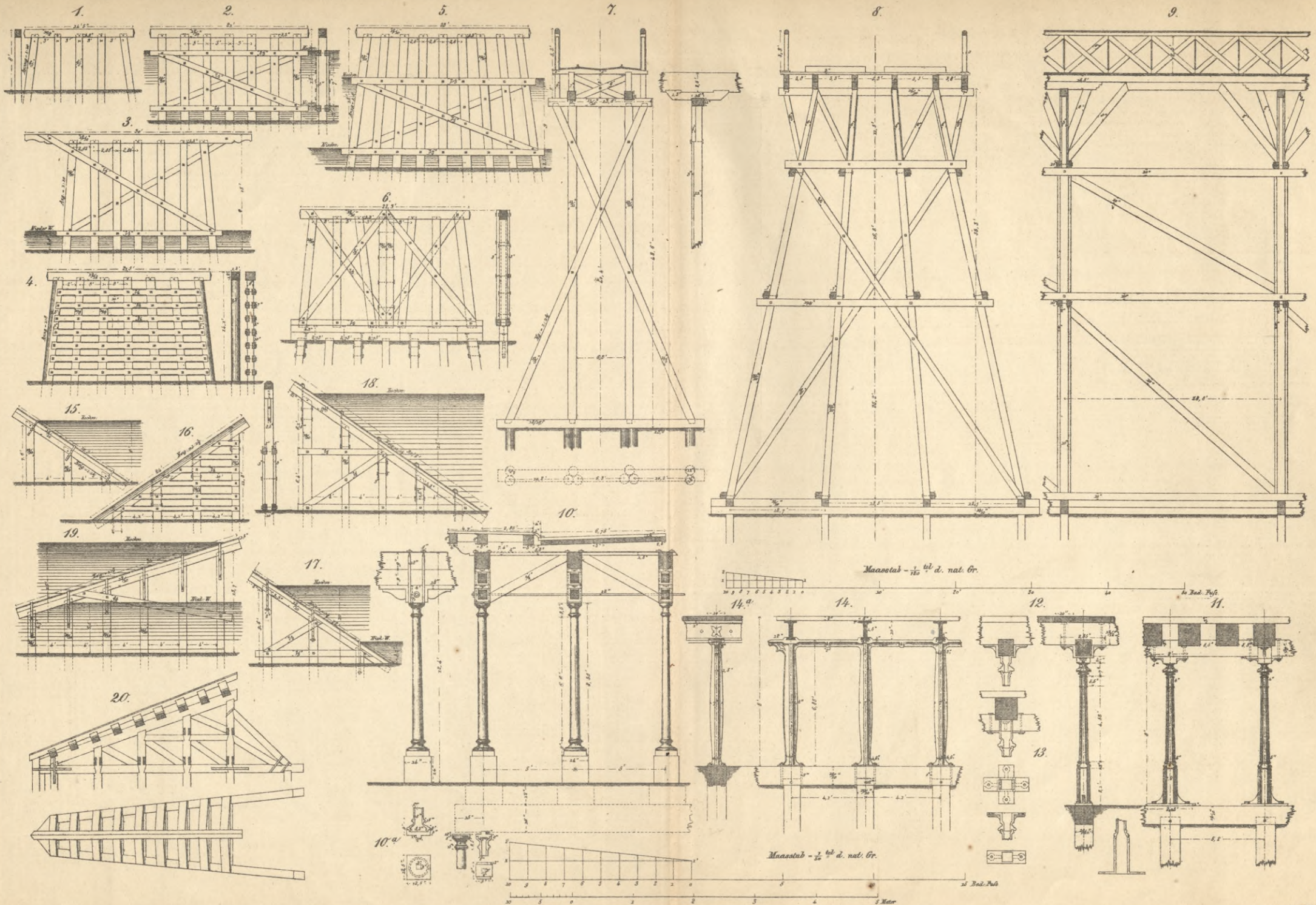

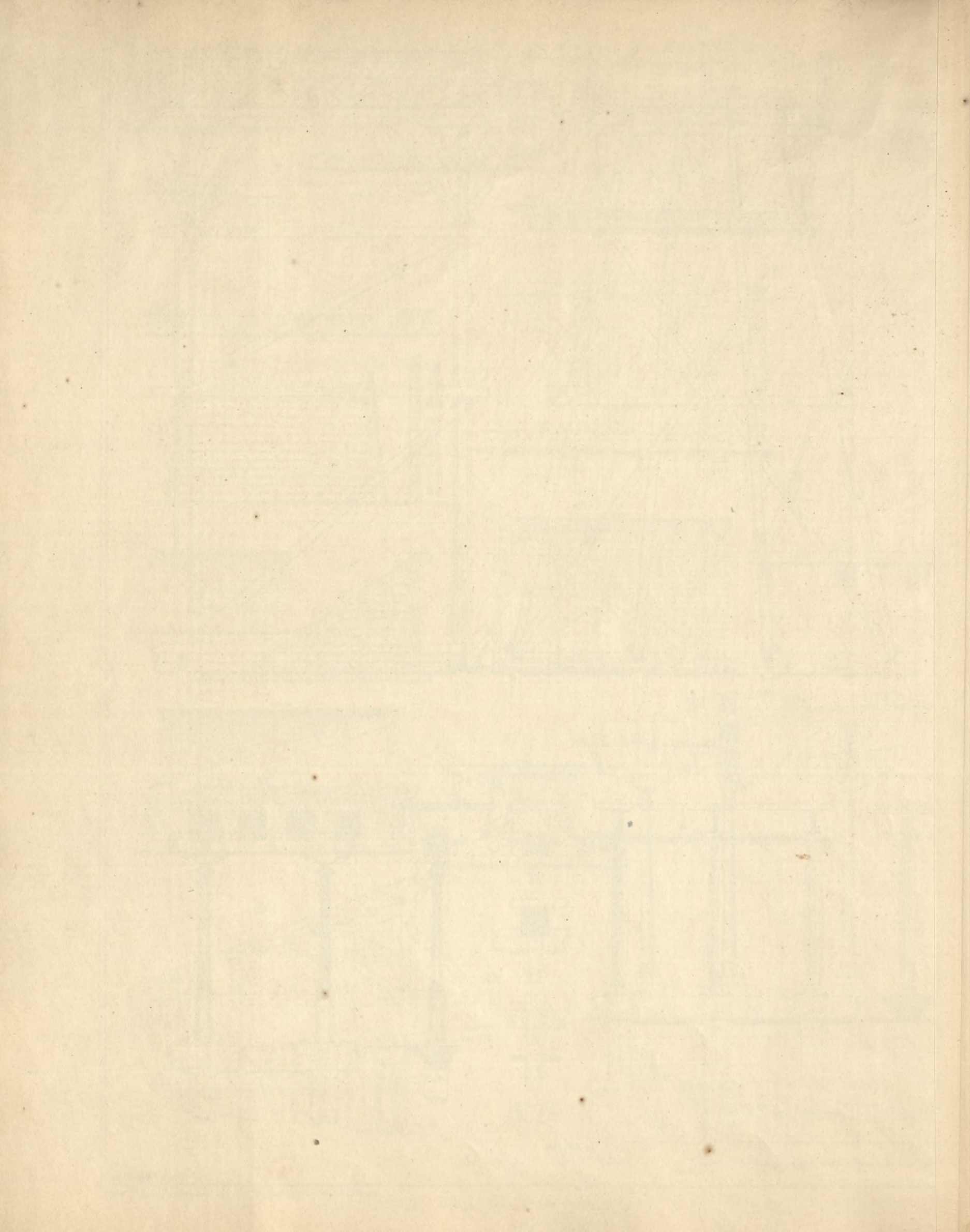

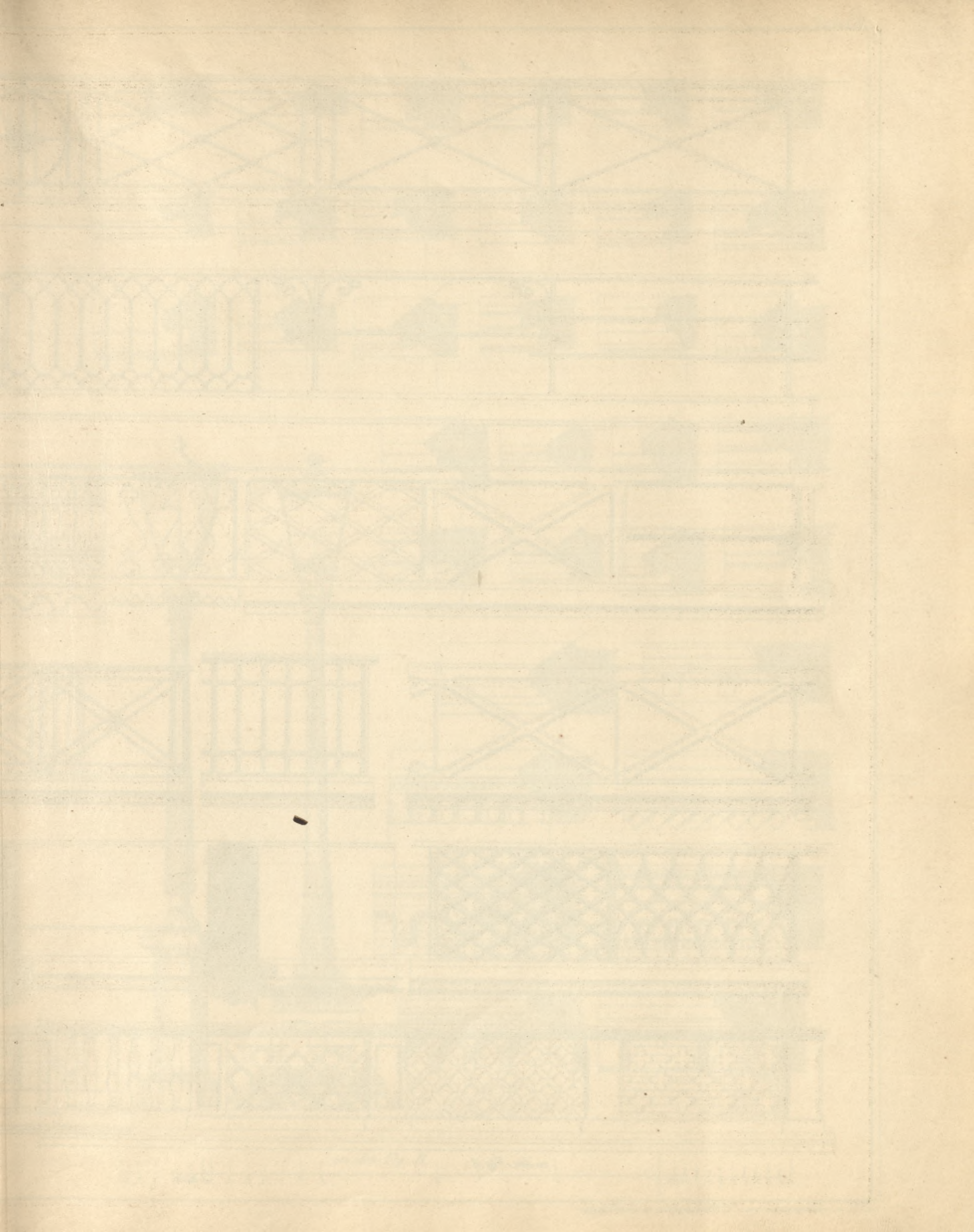

A.

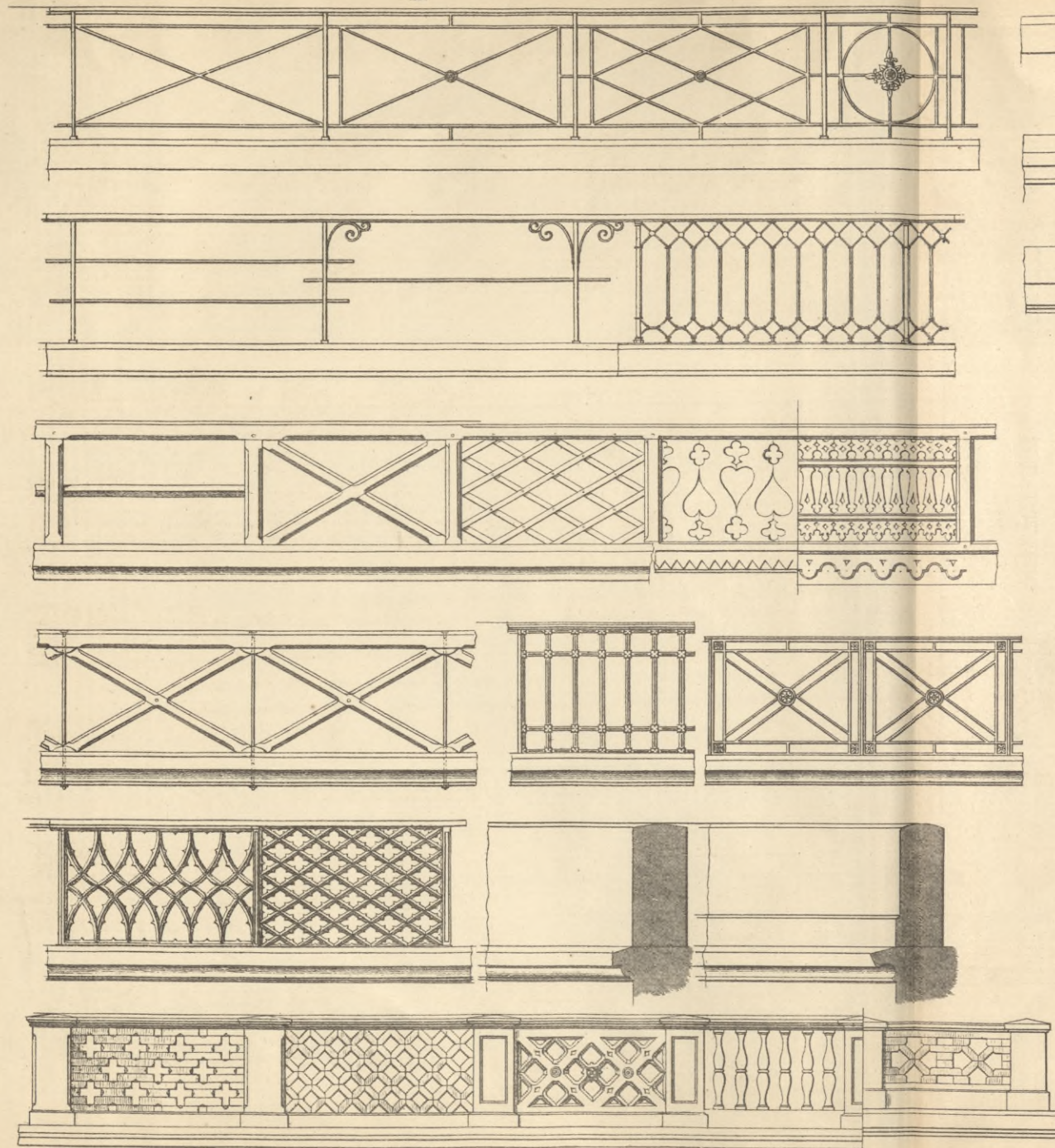

zu den Fig. A.

0 9 8 7 6 5 4 3 2 1 0

4 Meter

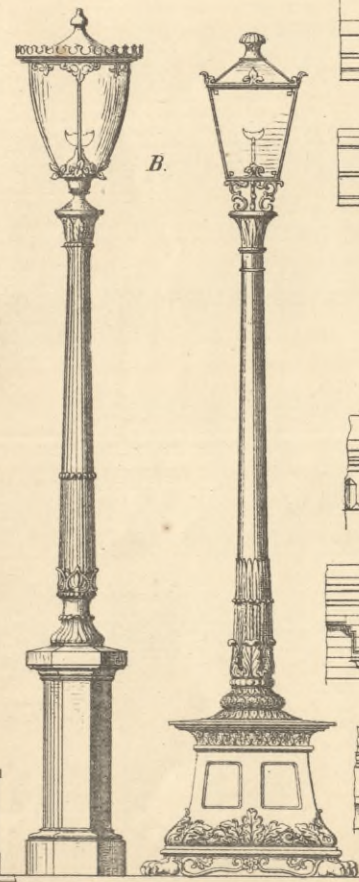
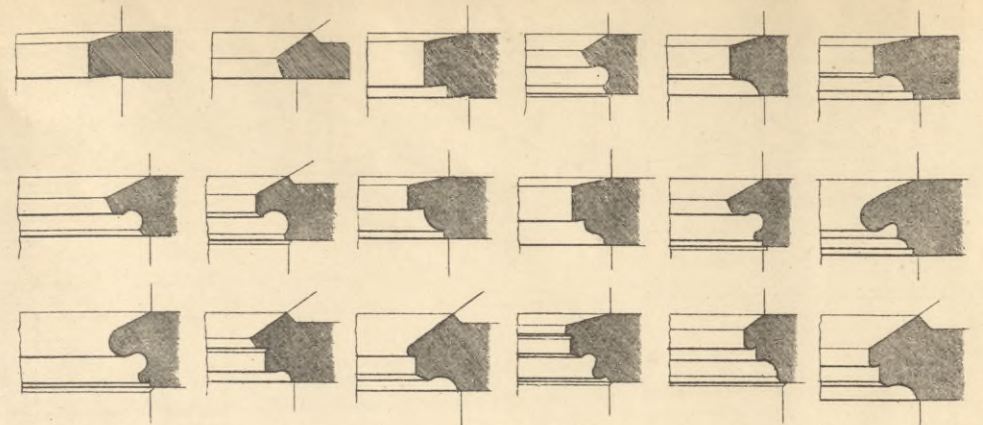

B.

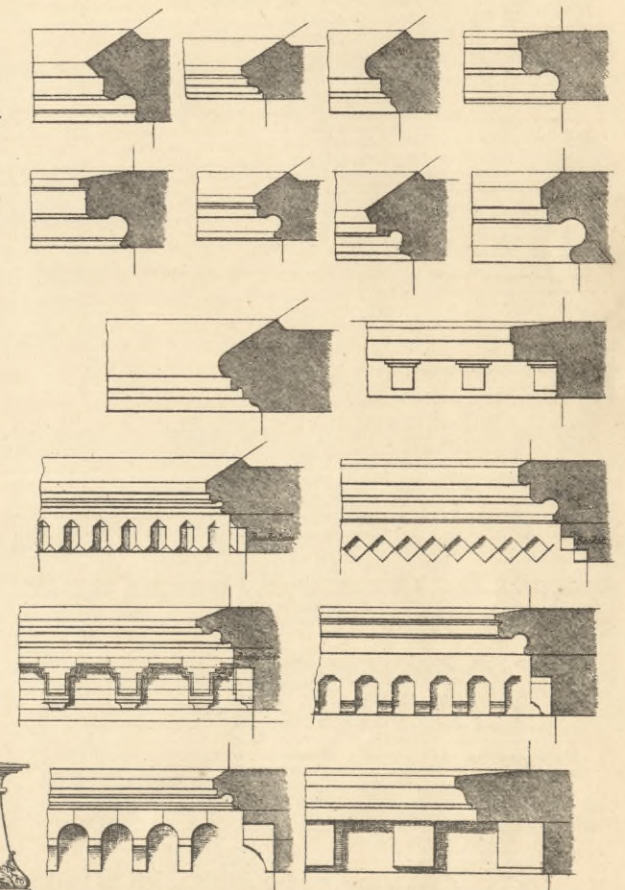

zu den Fig. B.

0 9 8 7 6 5 4 3 2 1 0

2 Meter

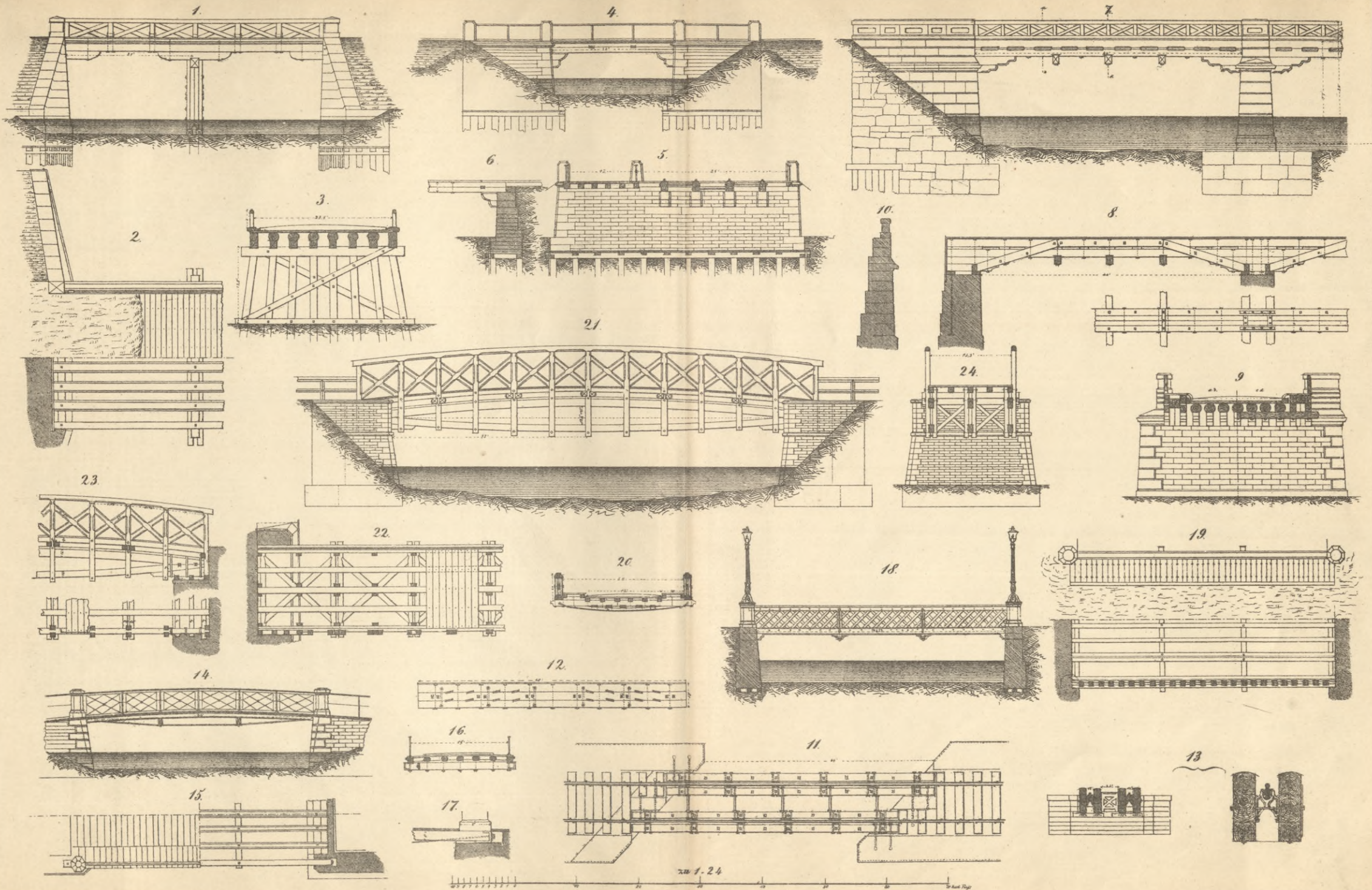

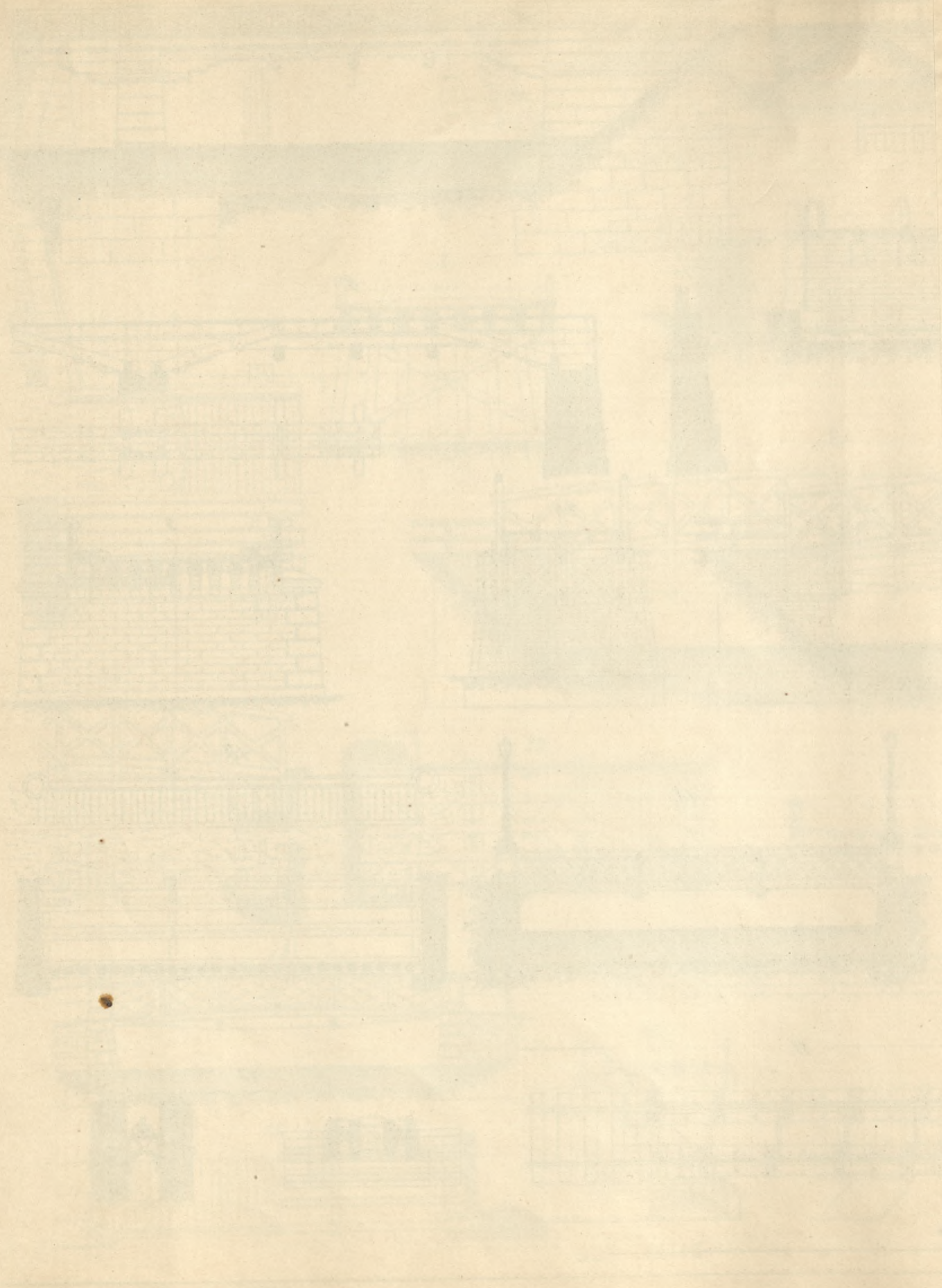

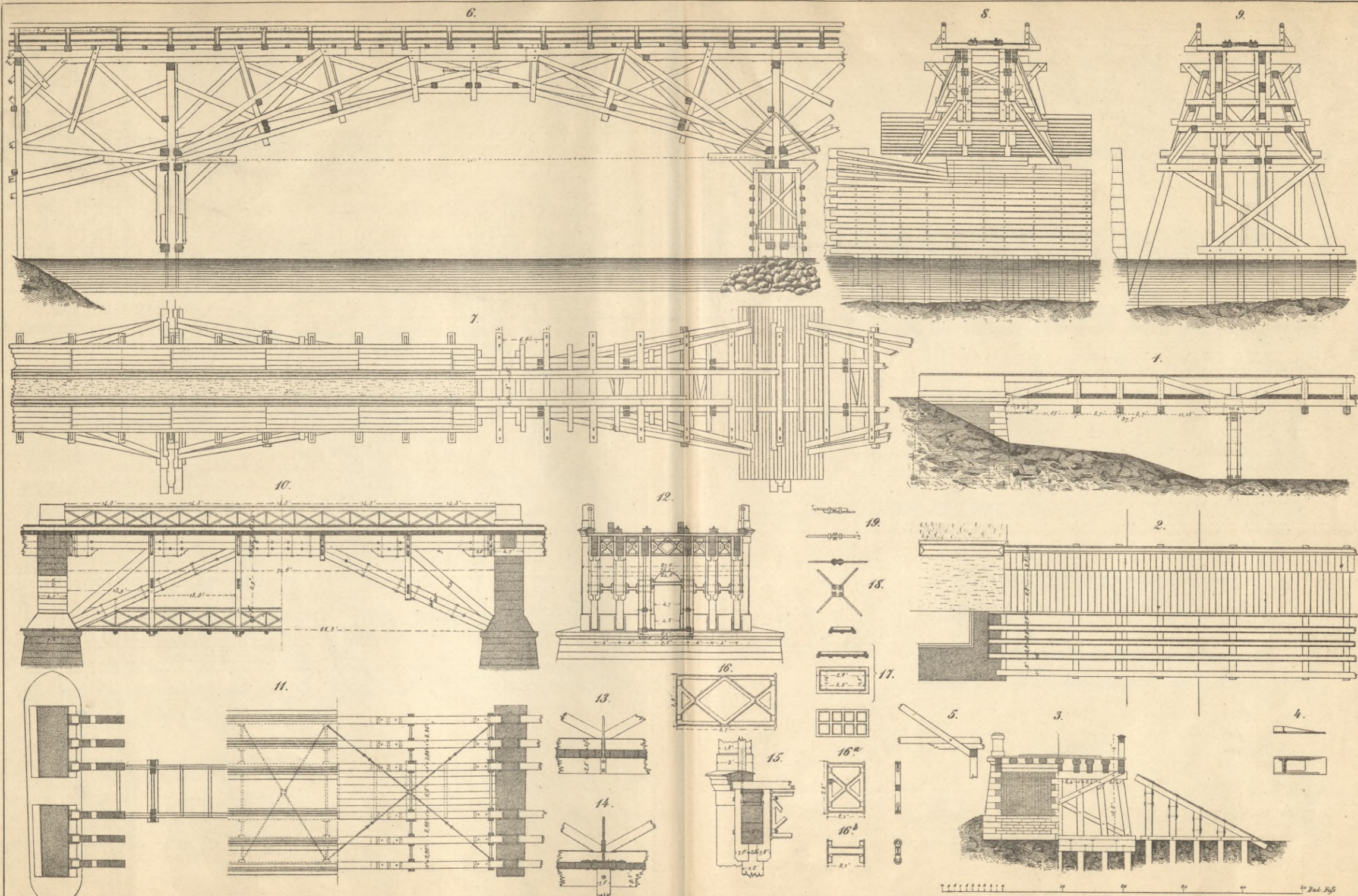

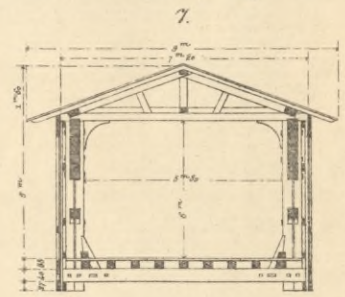
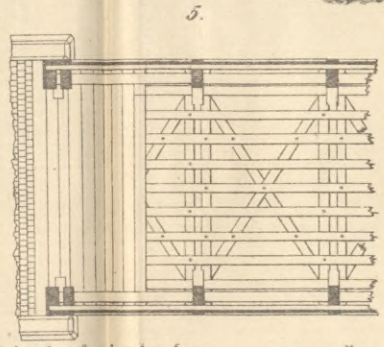
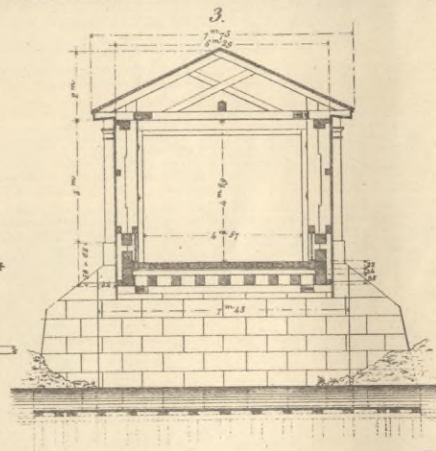
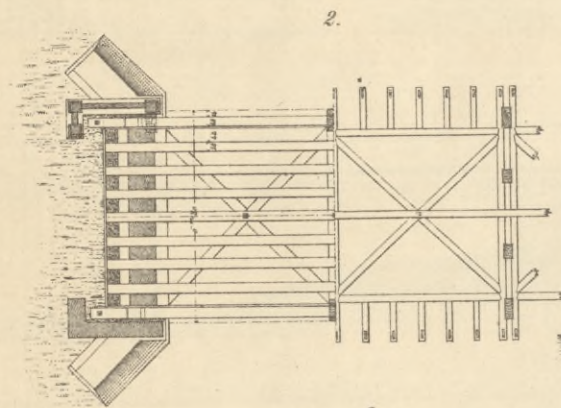
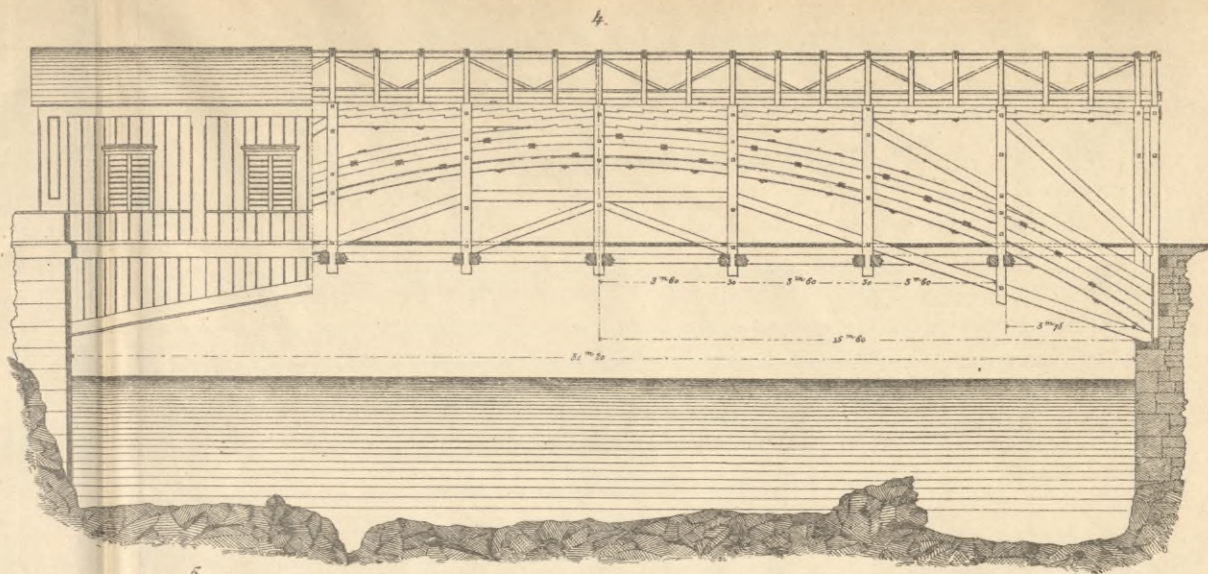
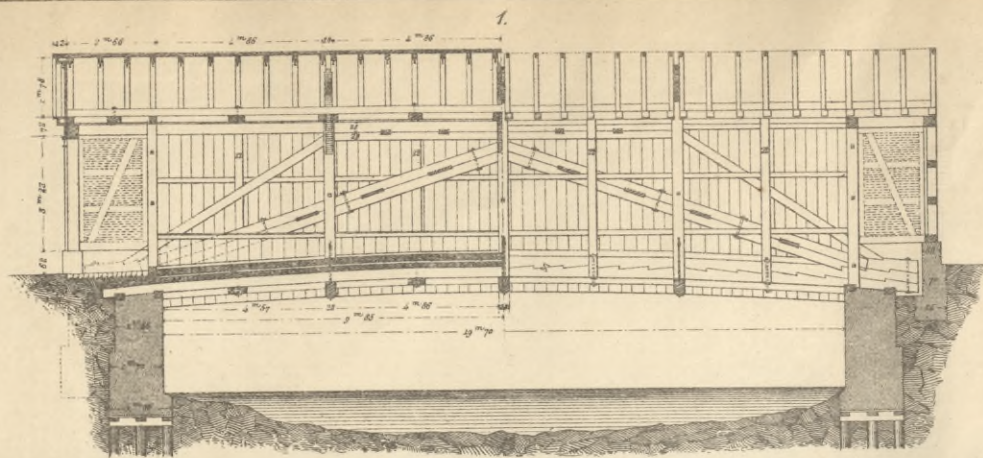

für Fig. 1. 2. 3. 4. 5. 6. 7.

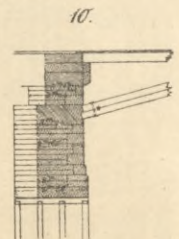
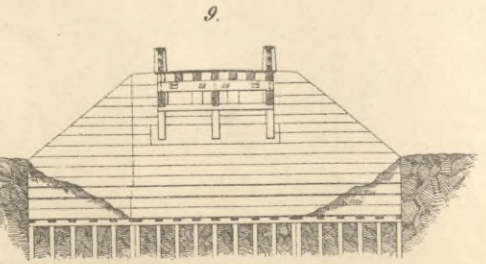
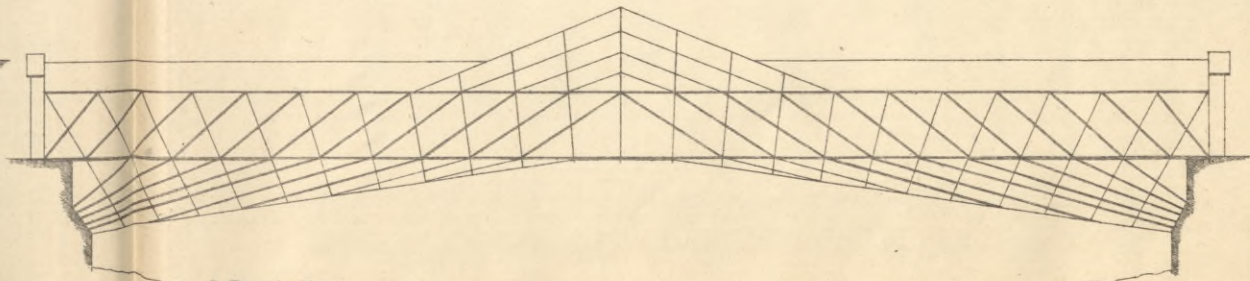
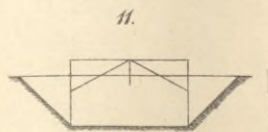
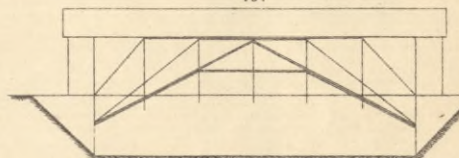
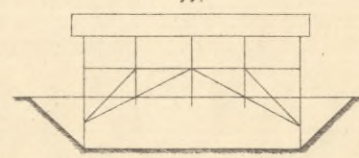
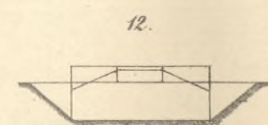
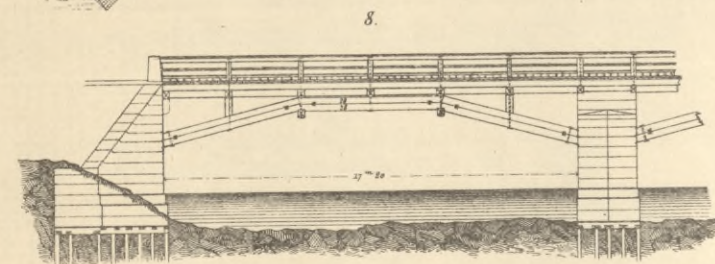

für Fig. 8. 9. 10.

für Fig. 11. bis 16.

0 5 10 15 20 Meter

0 5 10 20 30 40 Meter

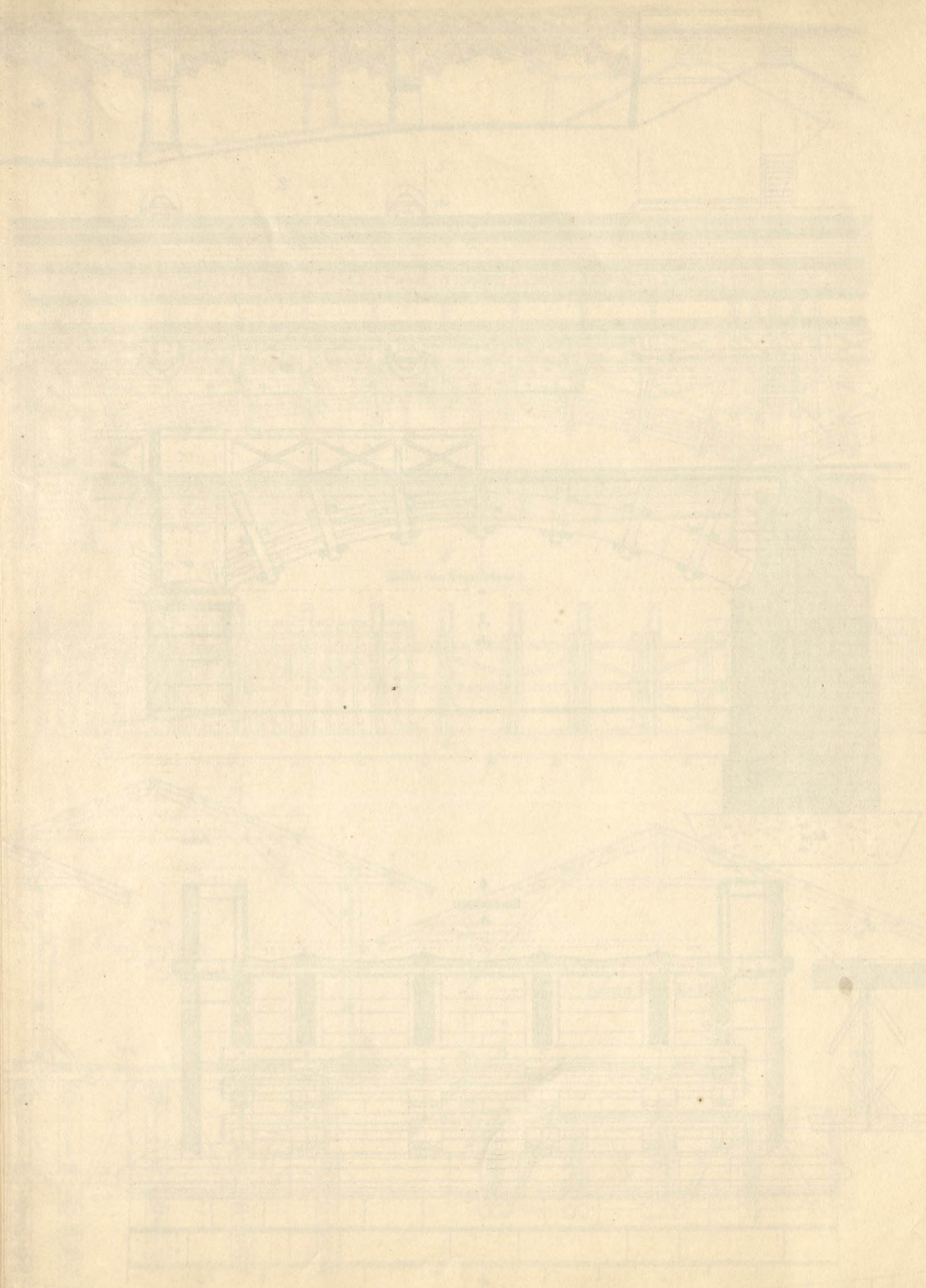

1.

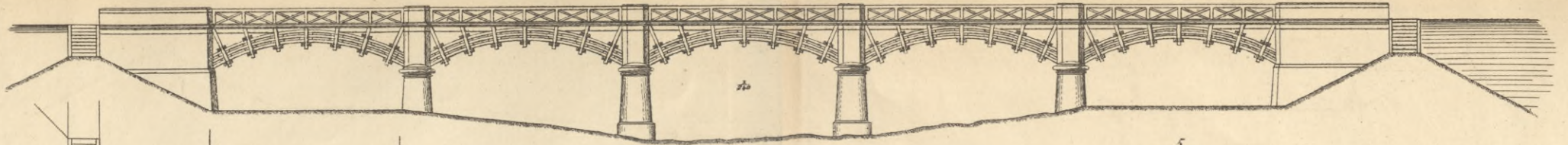

2.

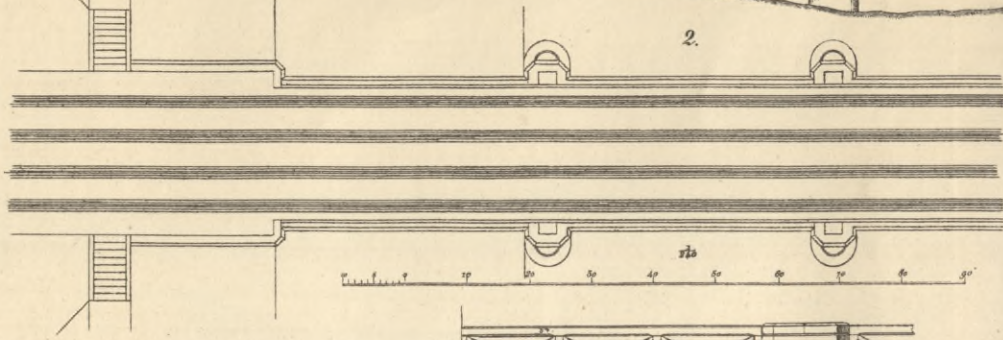

5.

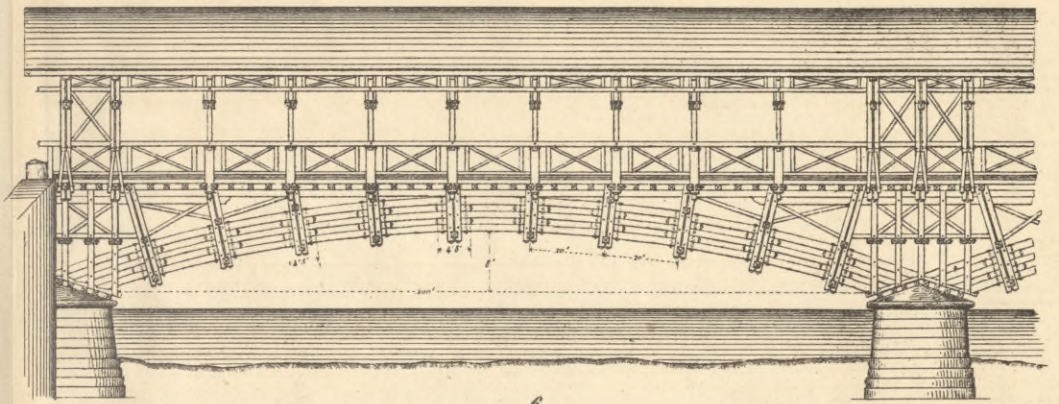

6.

Hälfte des Grundrisses.

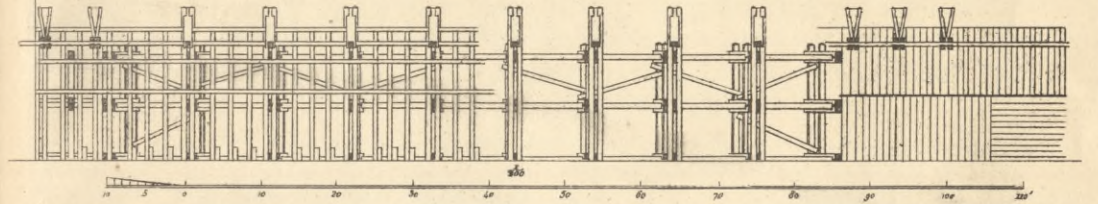

3.

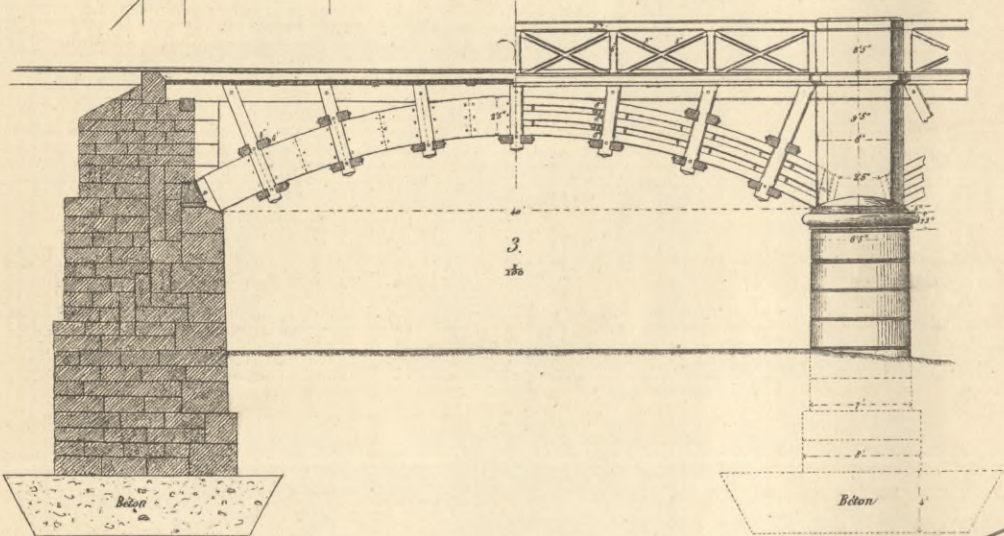

3a

4. Querschnitt

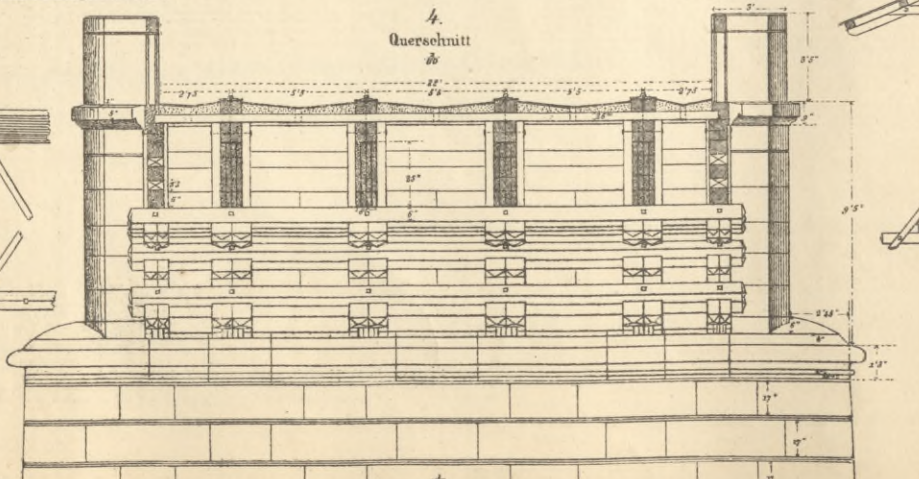

4a

7. Schnitt am Pfeiler.

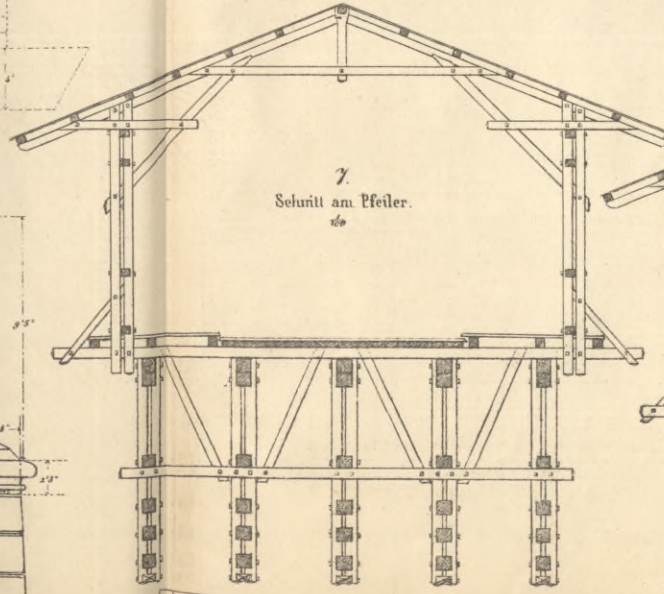

7a

8. Schnitt durch die Mitte.

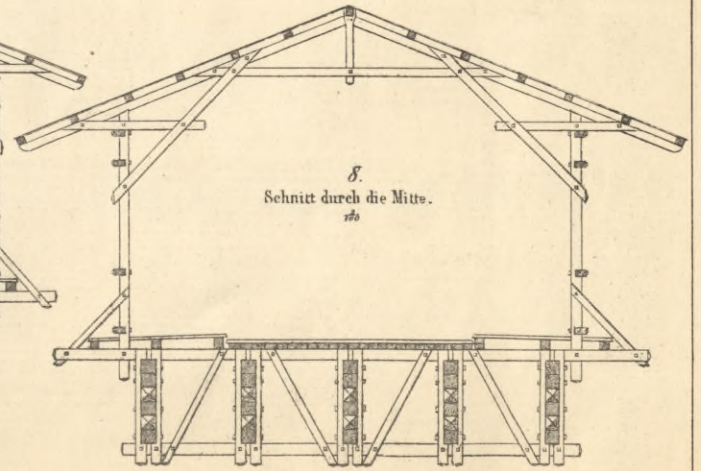

8a

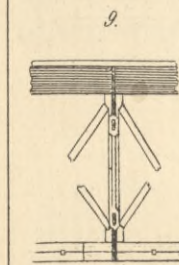

9.

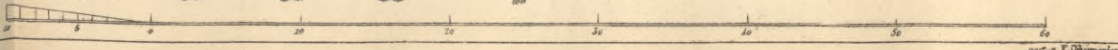
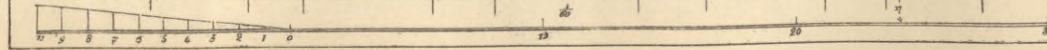

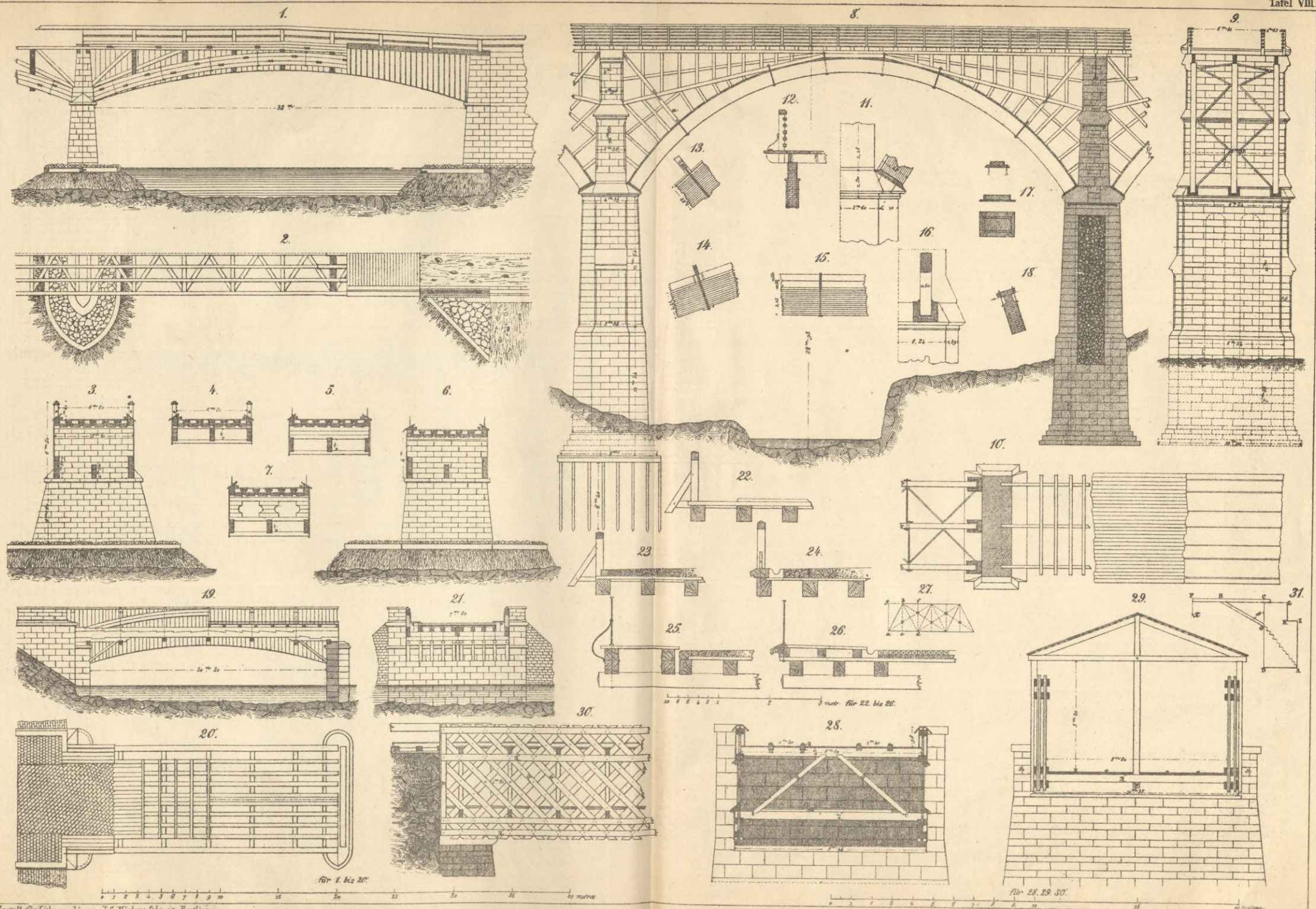

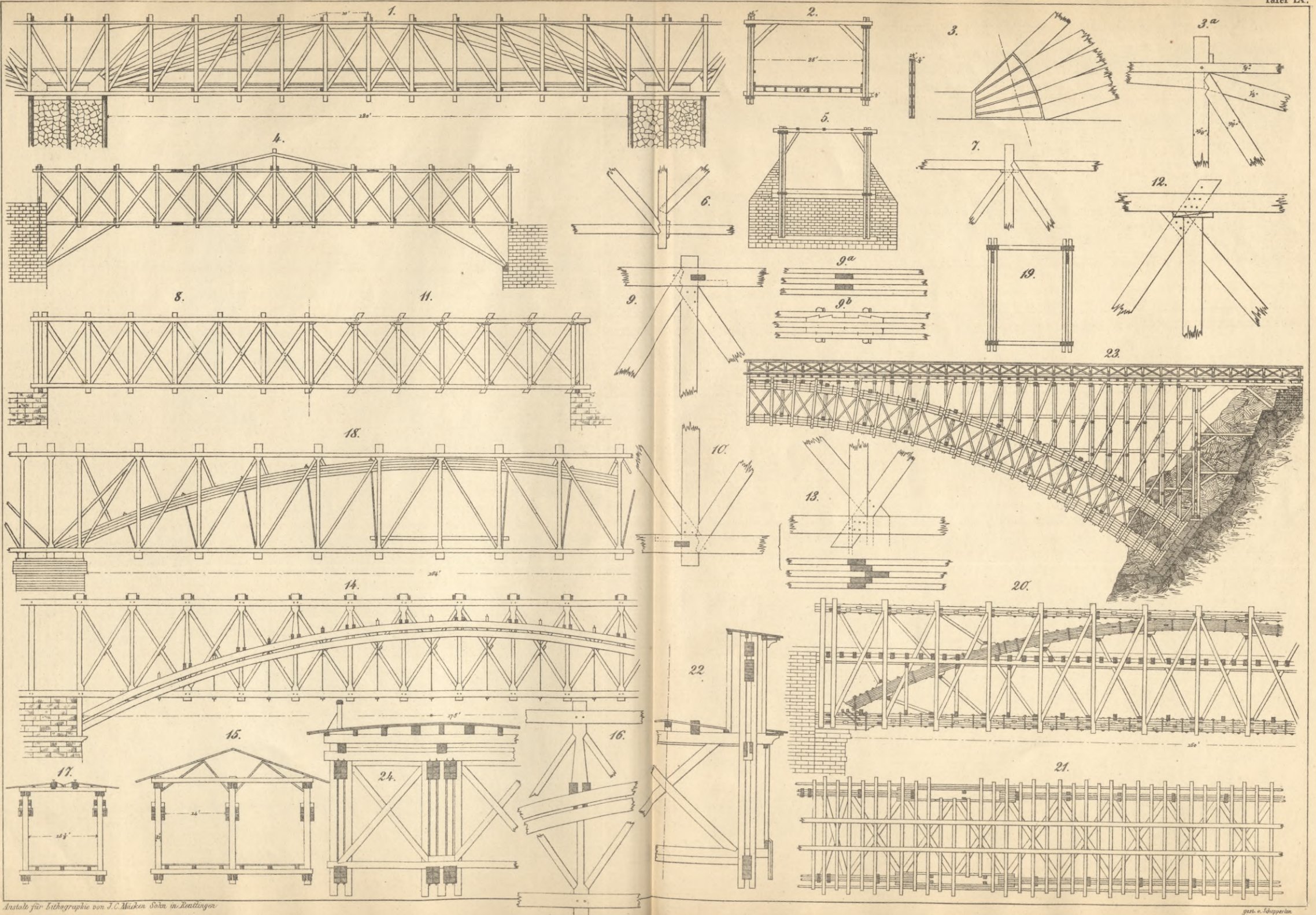

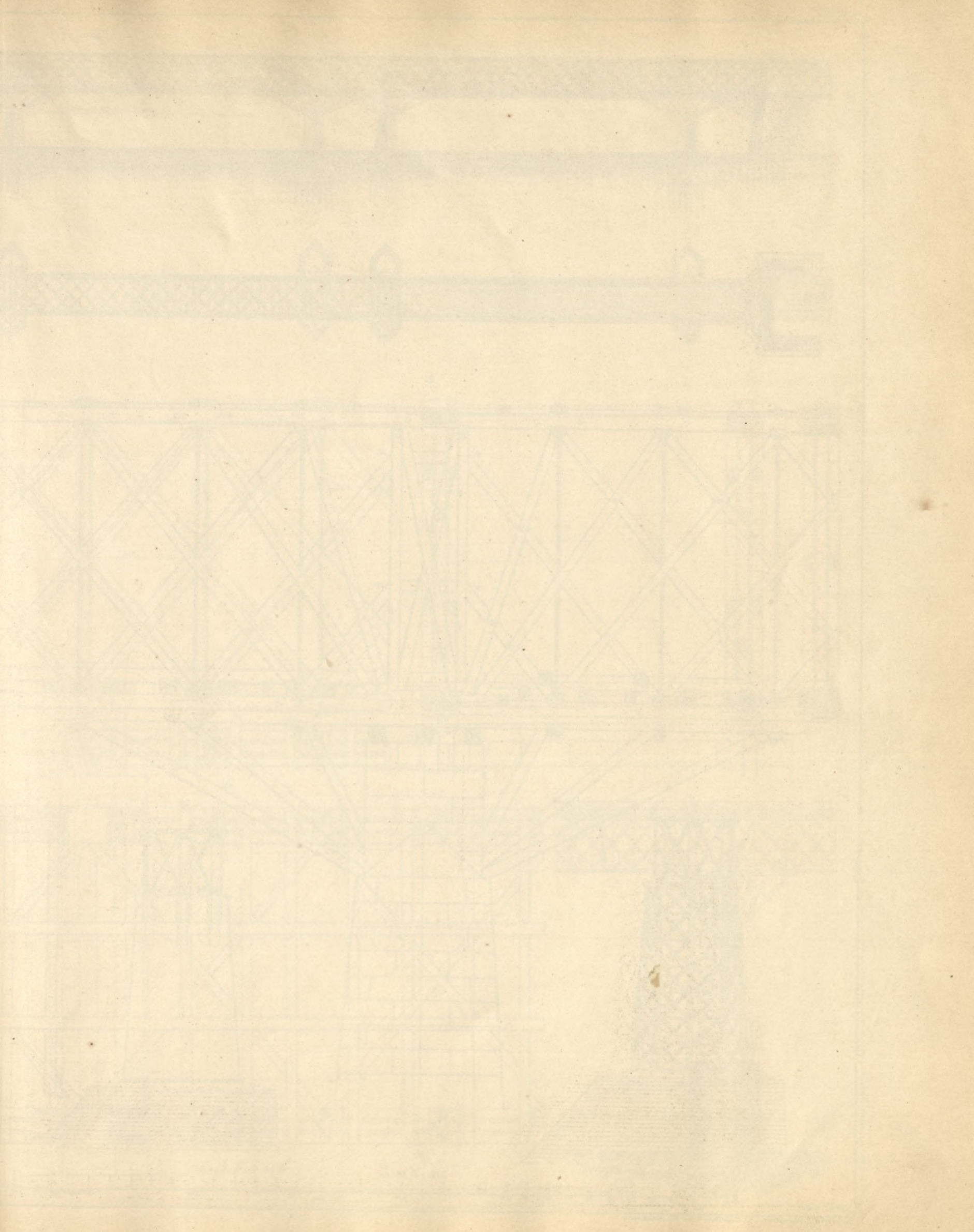

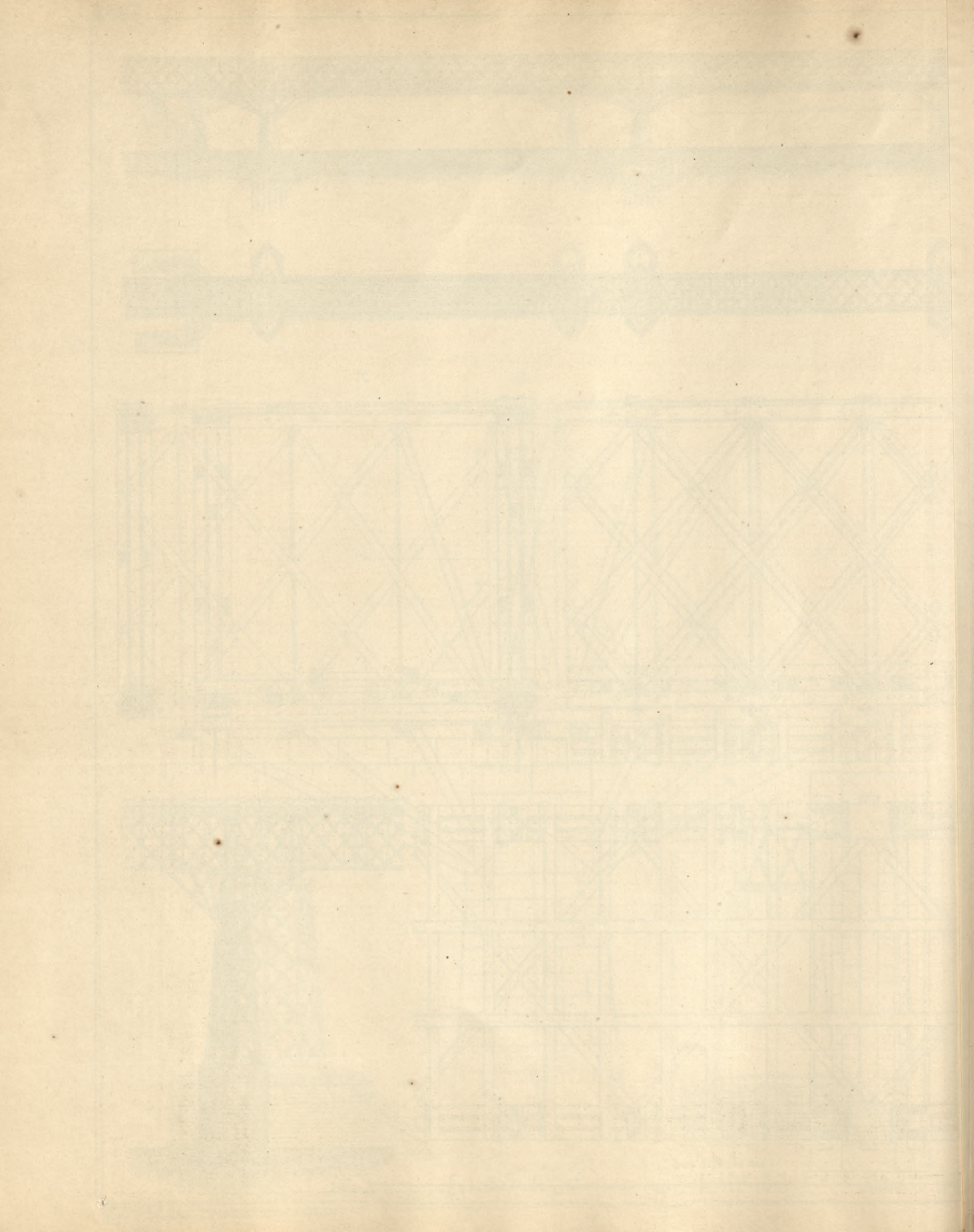

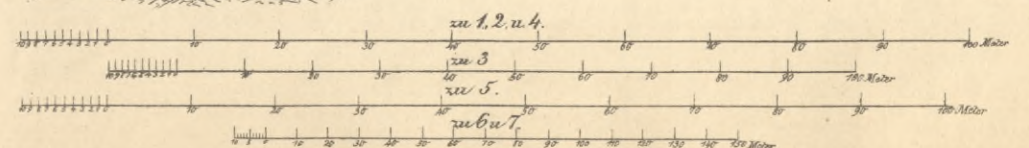
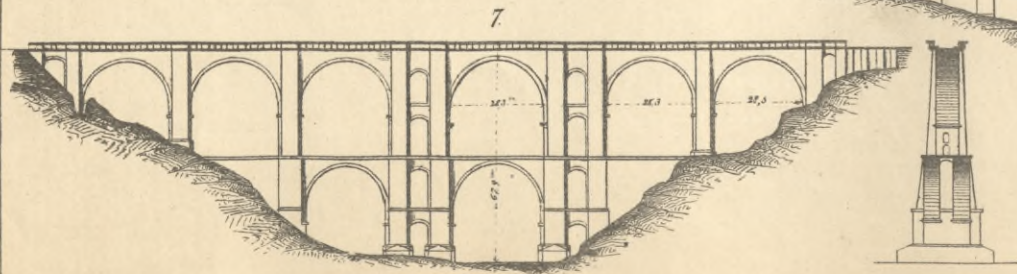
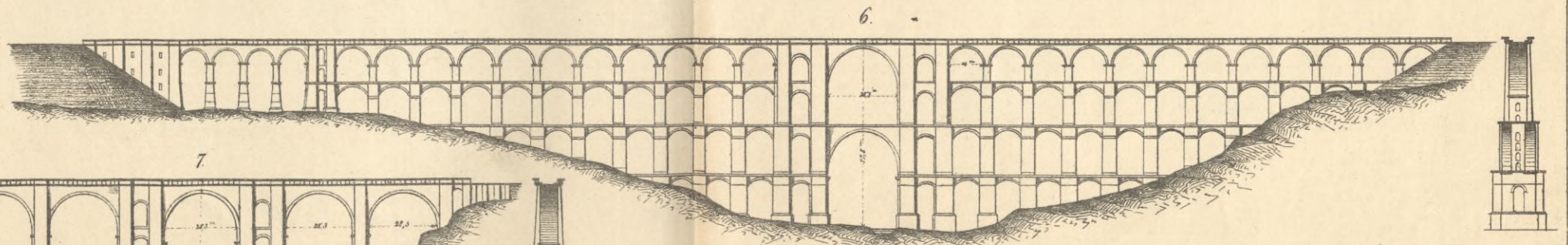
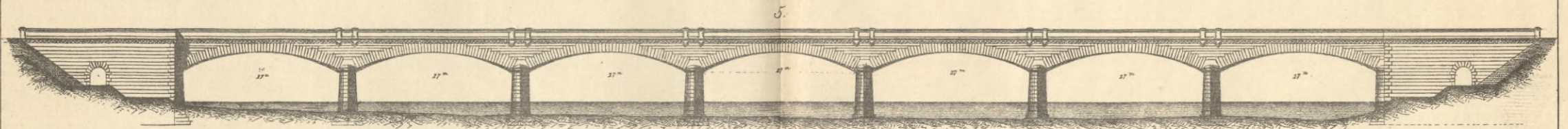
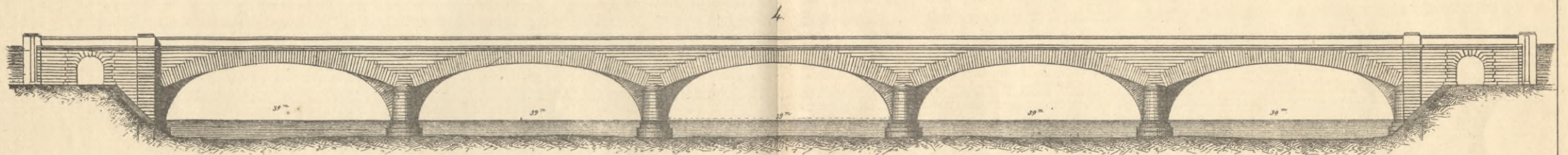
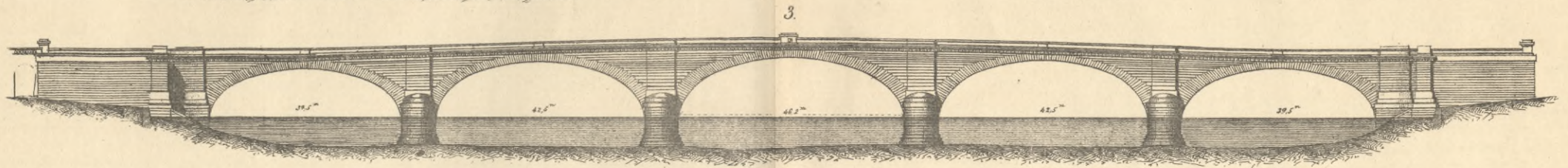
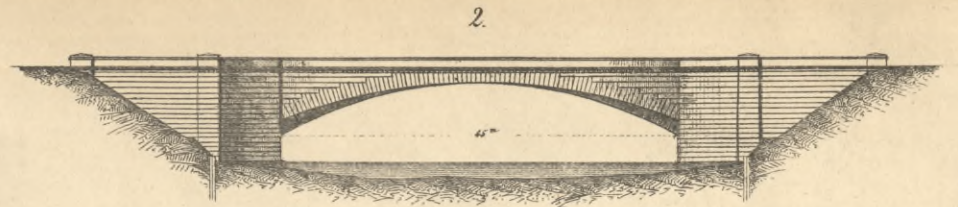
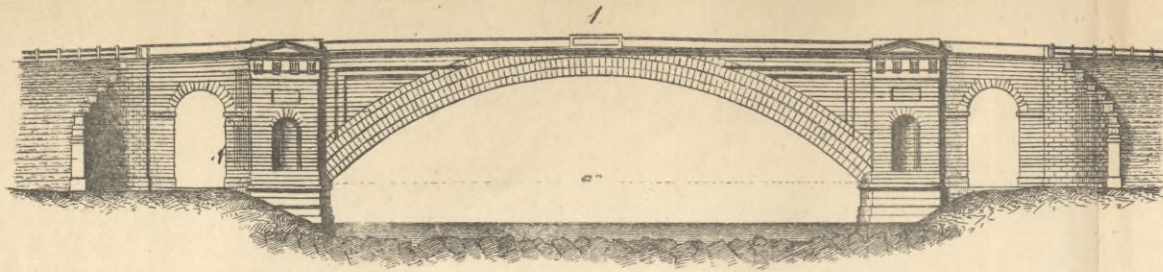

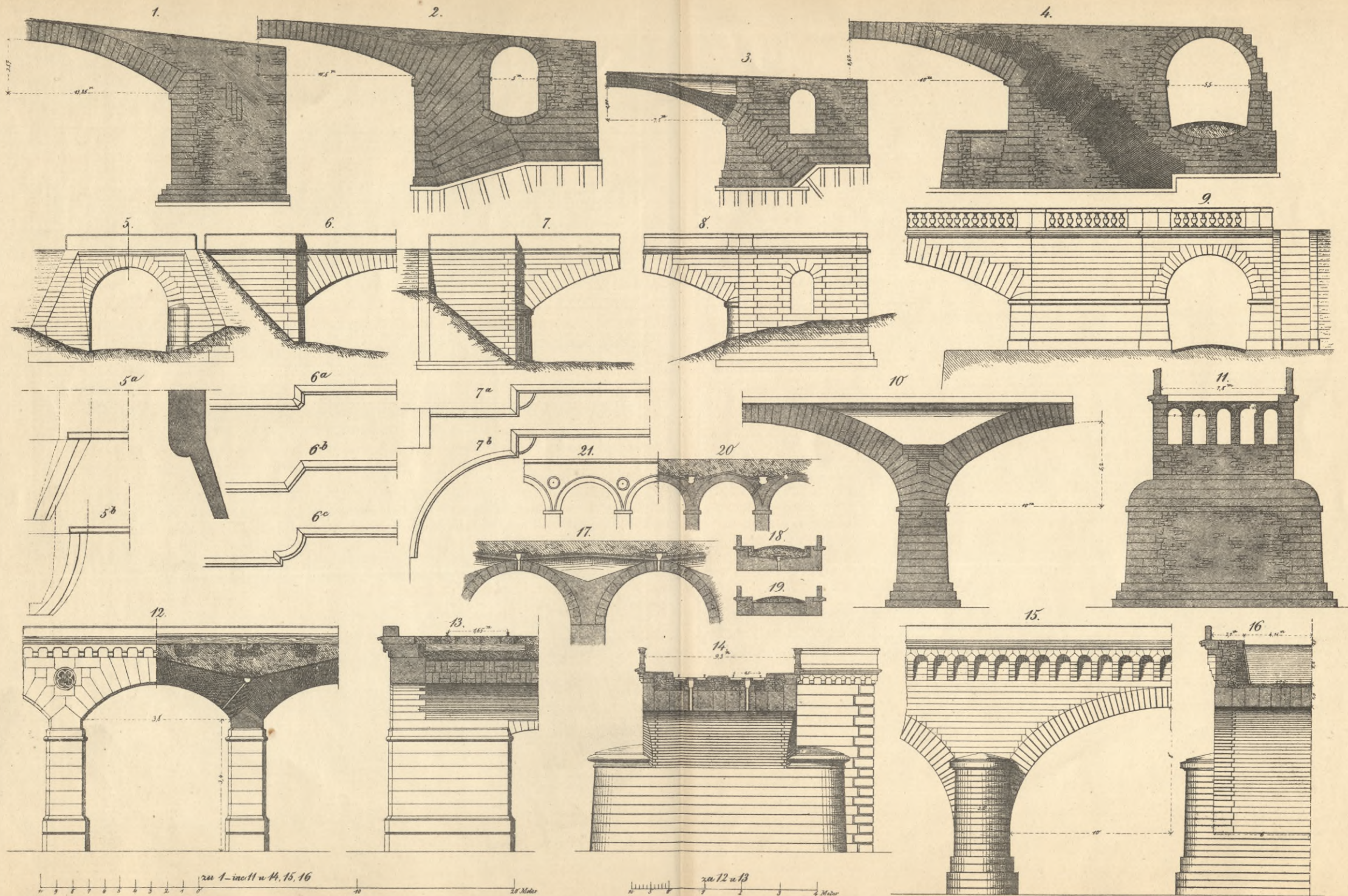

zu 1-11 u 14, 15, 16

zu 12 u 13

1

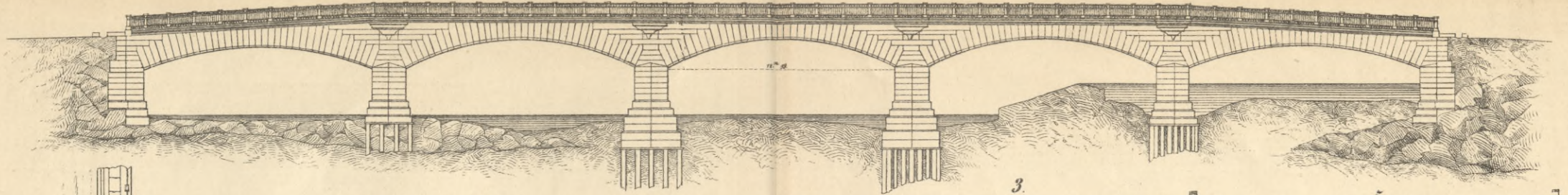

2

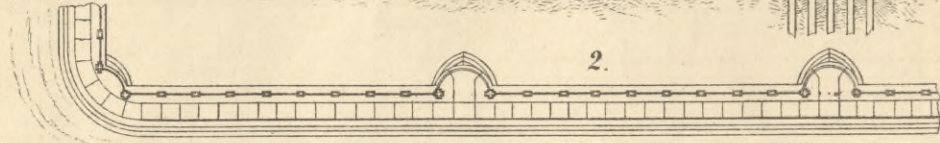

3

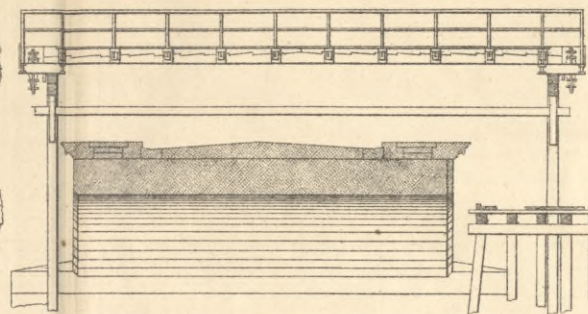

5

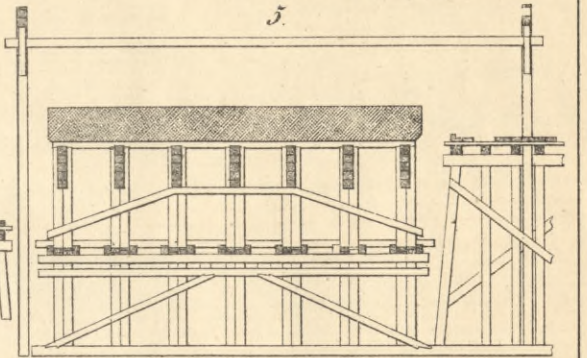

4

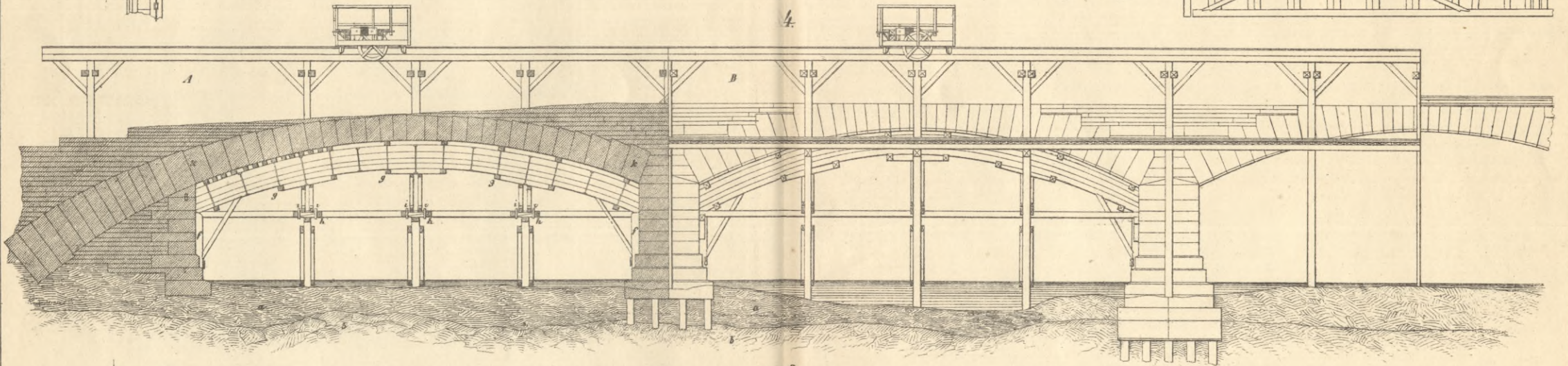

6

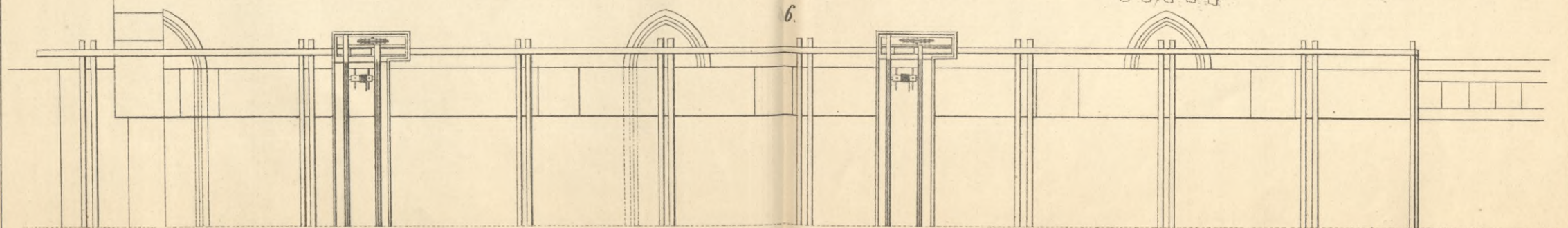

0 1 2 3 4 5 6 7 8 9 10 11 12 13 14 15 16 17 18 19 20 Meter zu 1 u 2

zu 34, 56 0 1 2 3 4 5 6 7 8 9 10 11 12 13 14 15 16 17 18 19 20 Meter

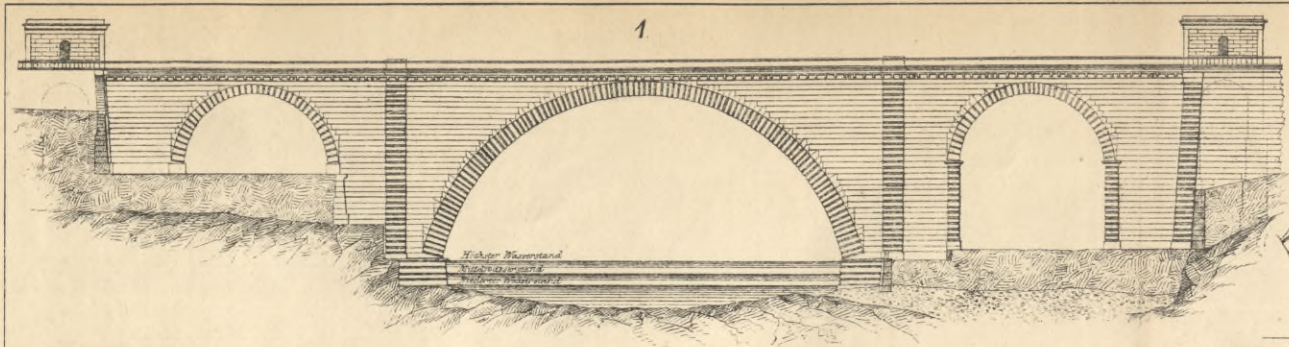

10 20 30 40 50 60 70 80 90 100
 in Meter zu 1 u. 2.

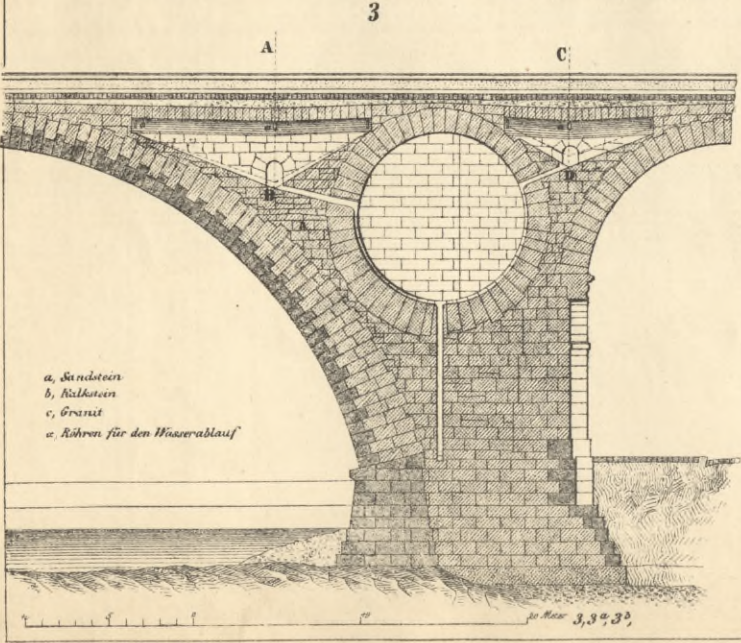
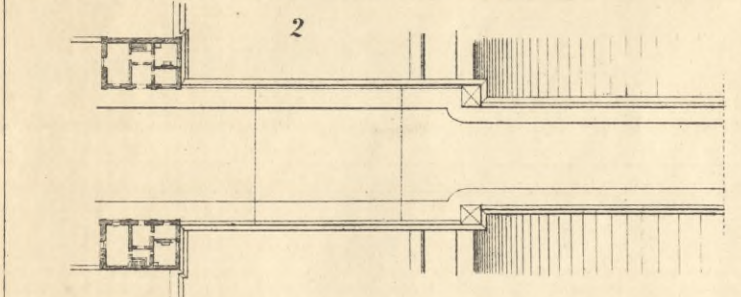
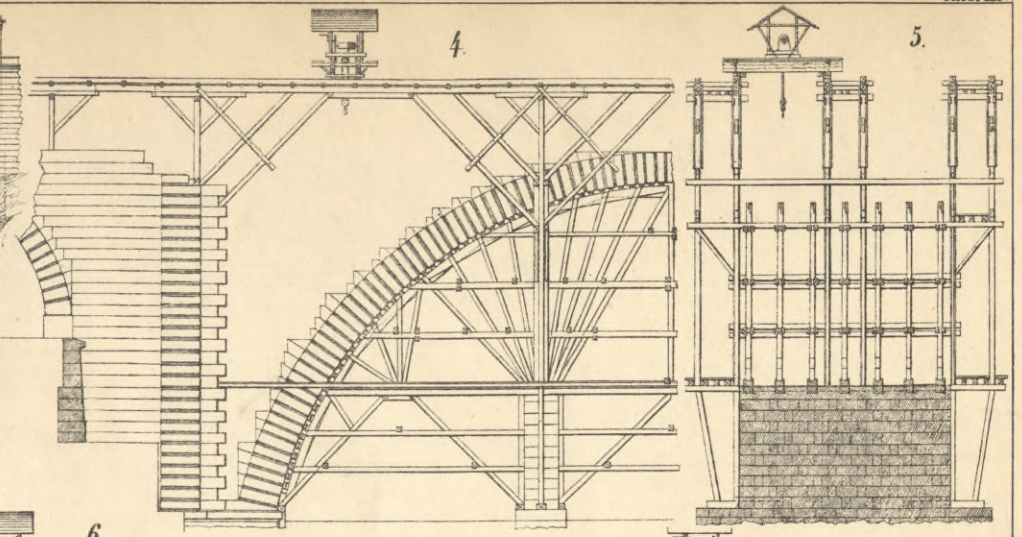

a, Sandstein
 b, Kalkstein
 c, Granit
 e, Röhren für den Wasserablauf

zu Meter 3,39,30

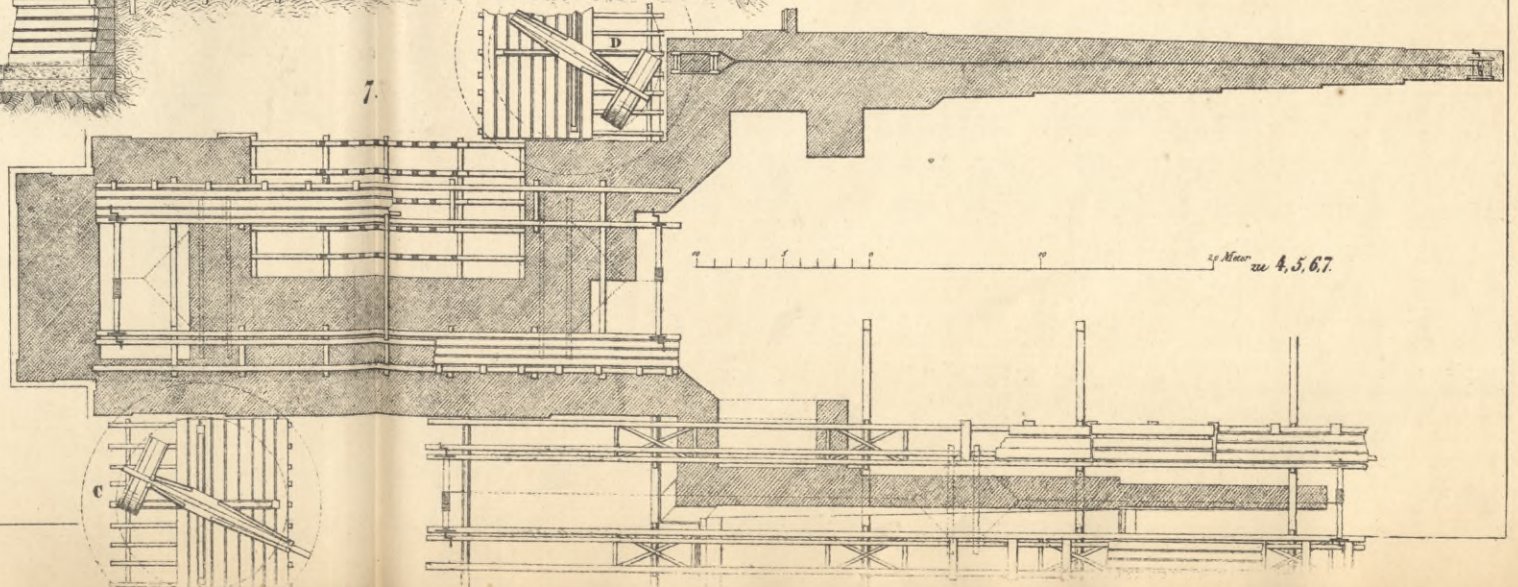
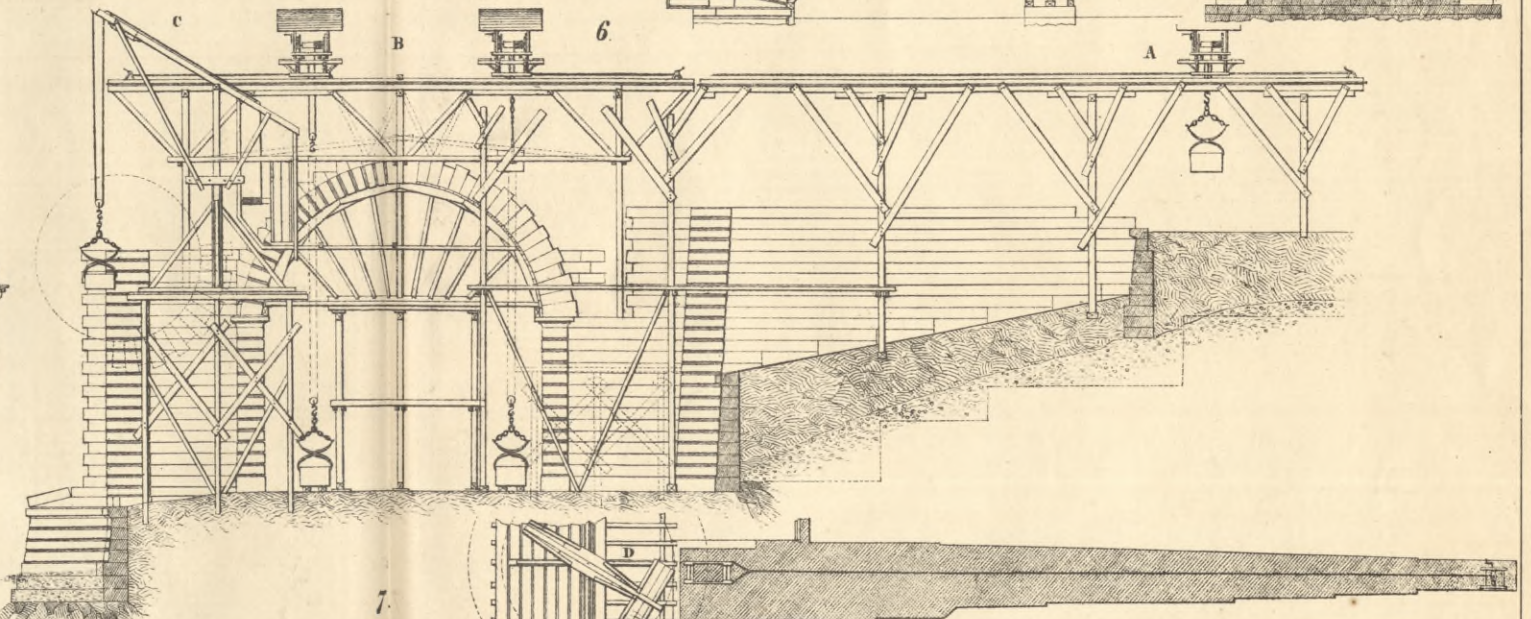

10 20 30 40 50 60 70 80 90 100
 in Meter zu 4, 5, 6, 7.

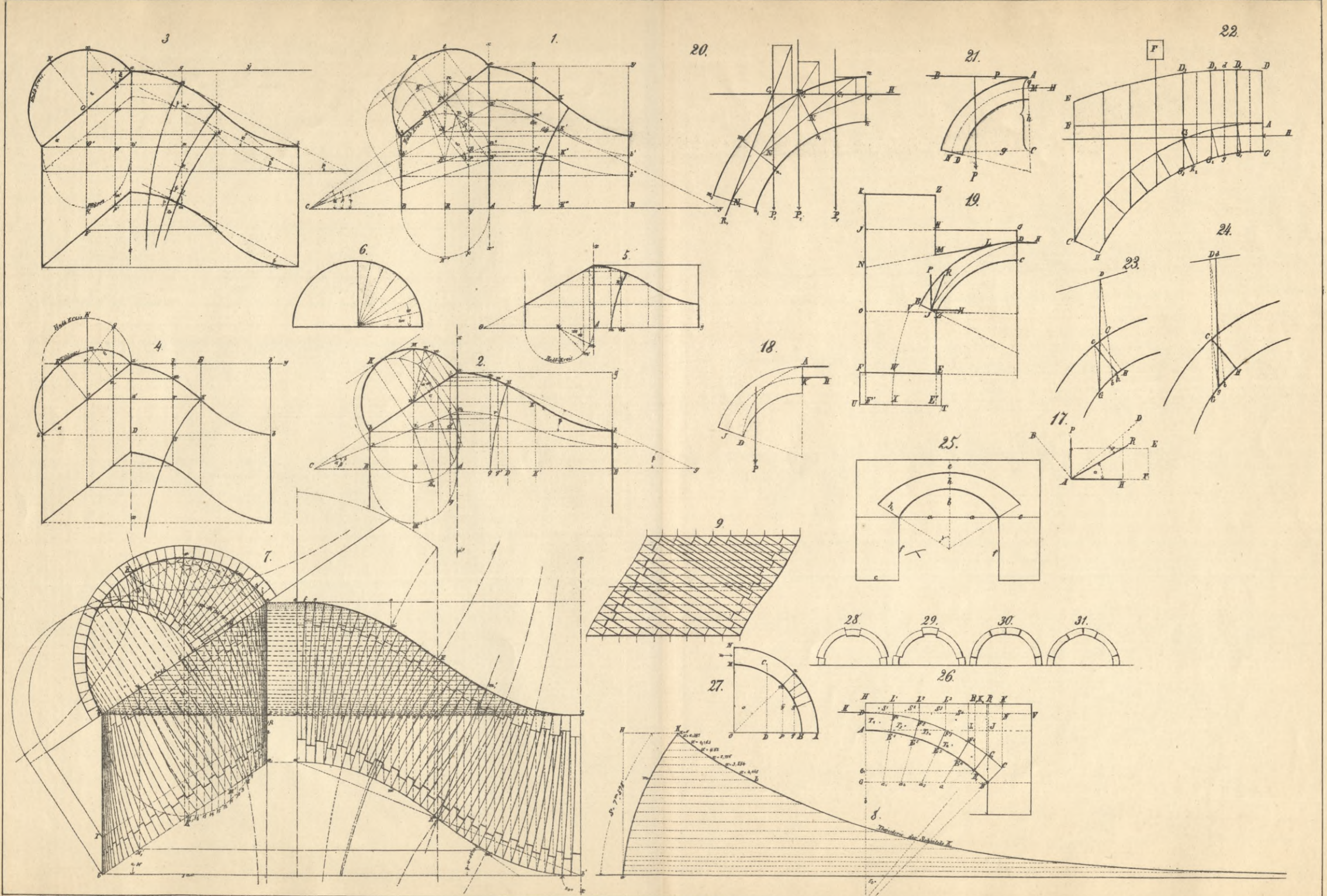

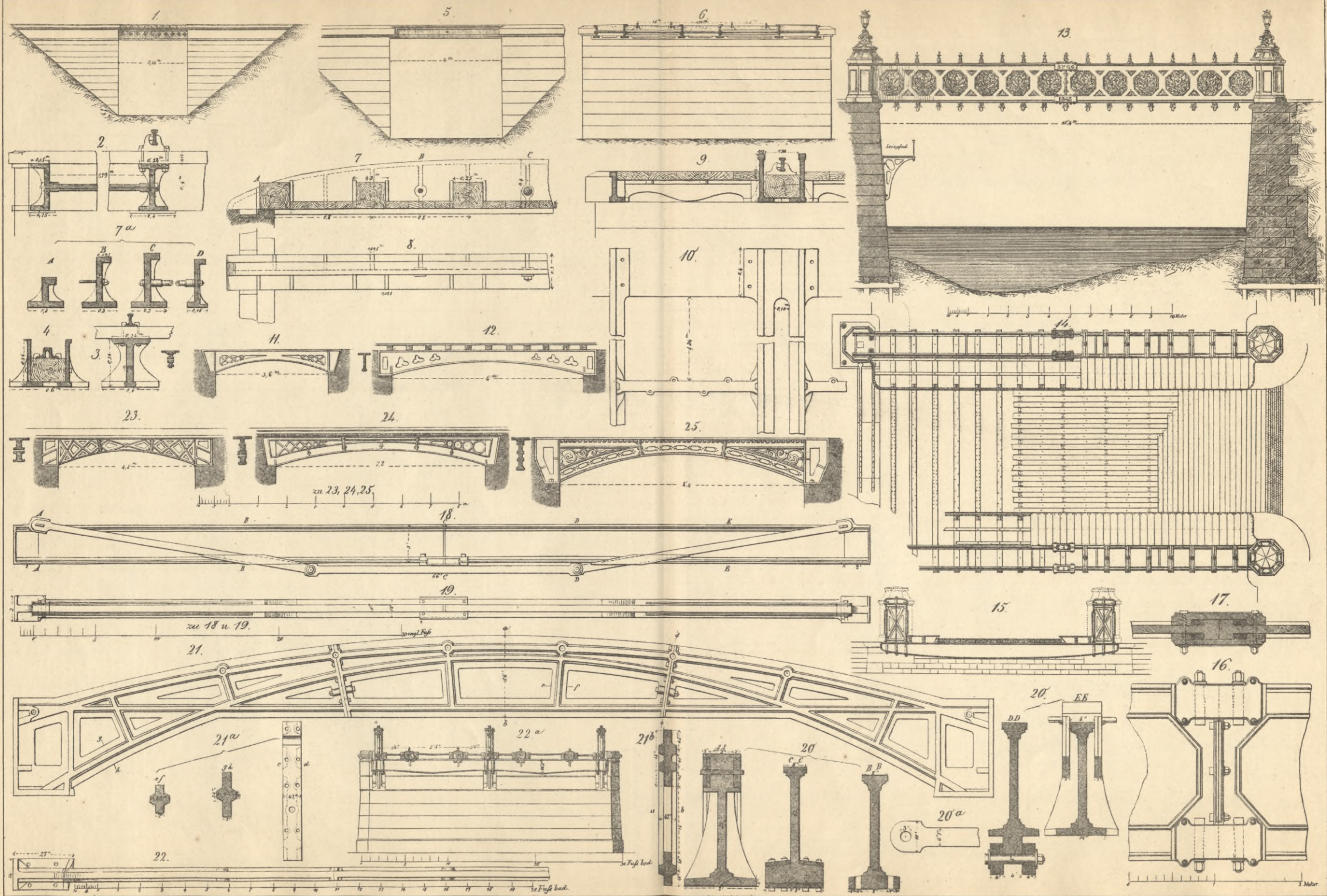

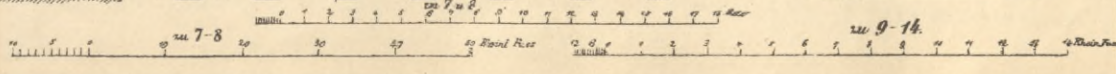
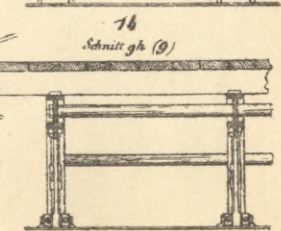
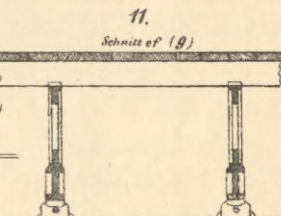
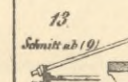
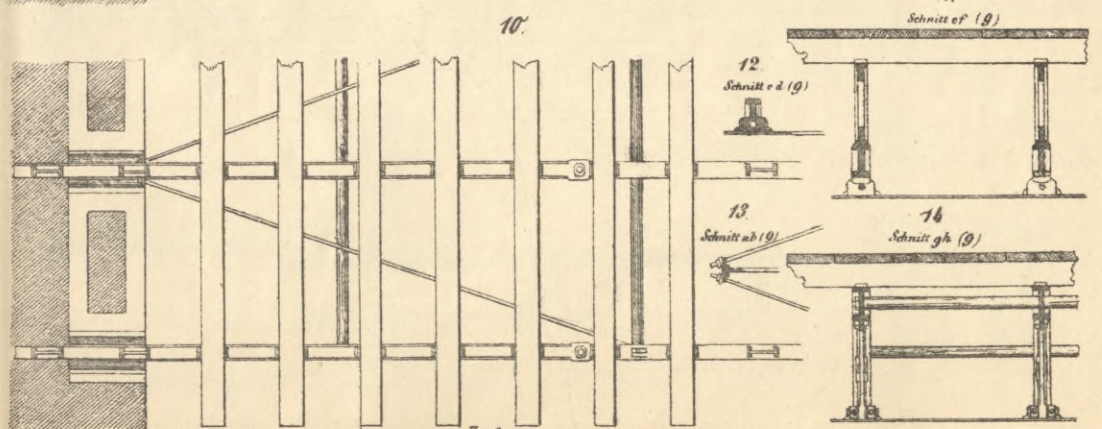
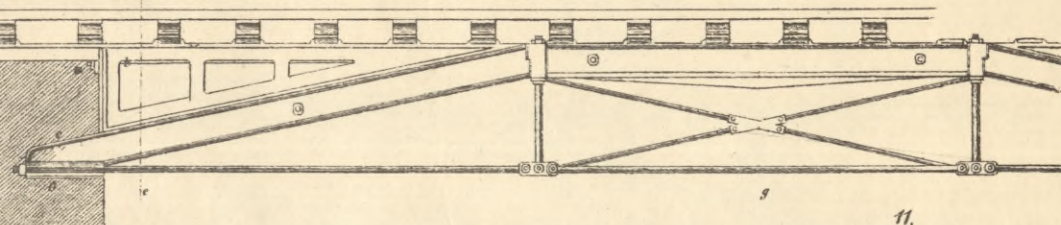
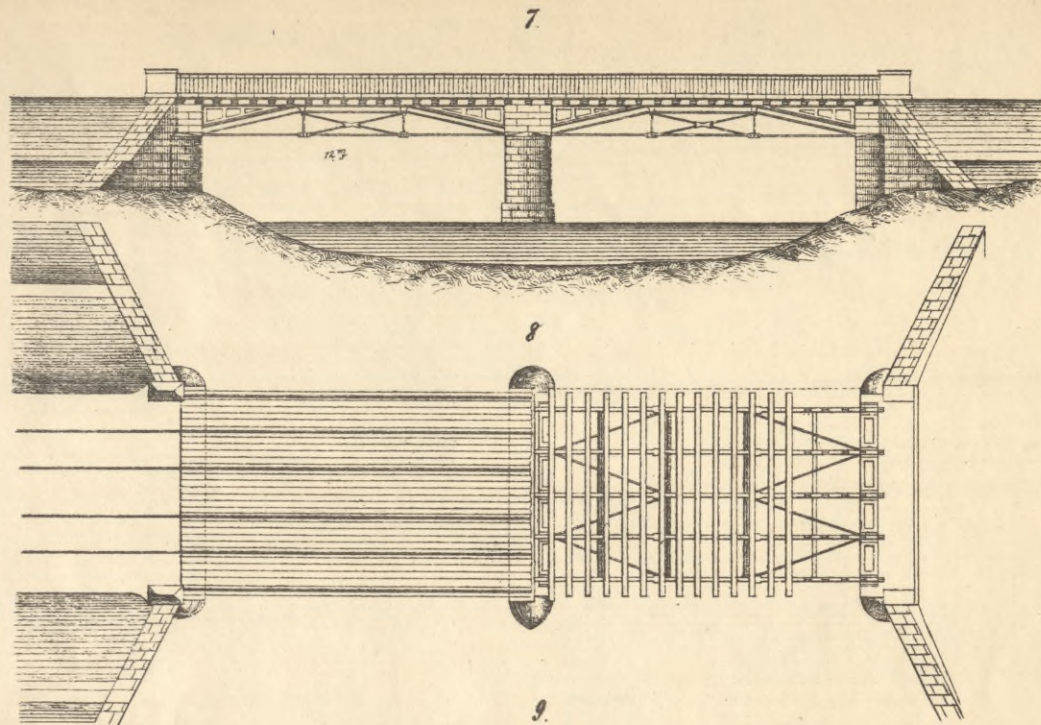
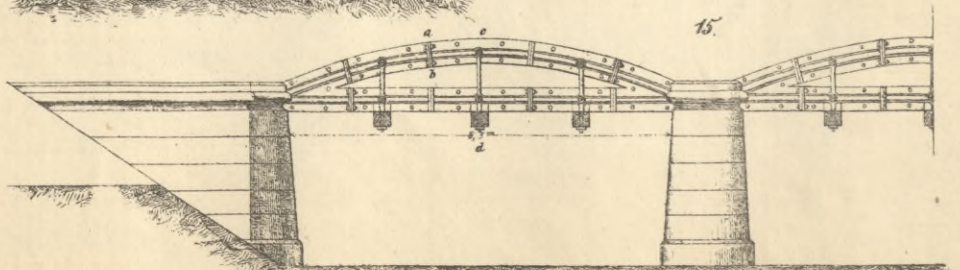
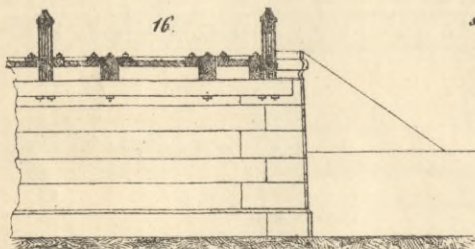
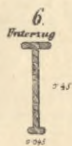
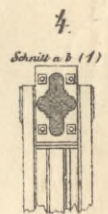
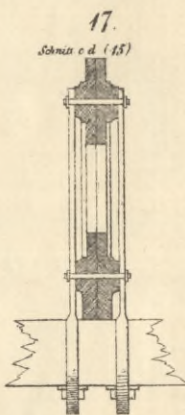
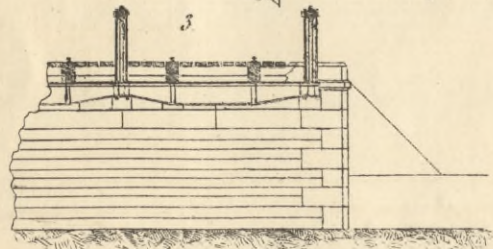
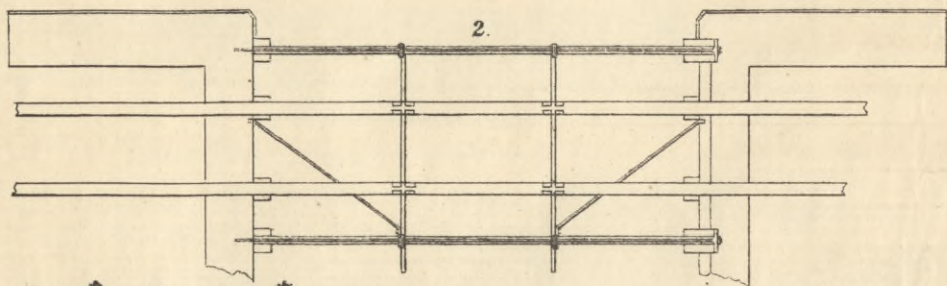
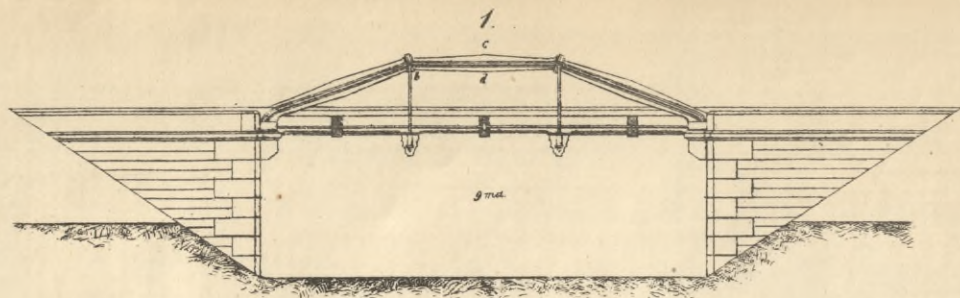

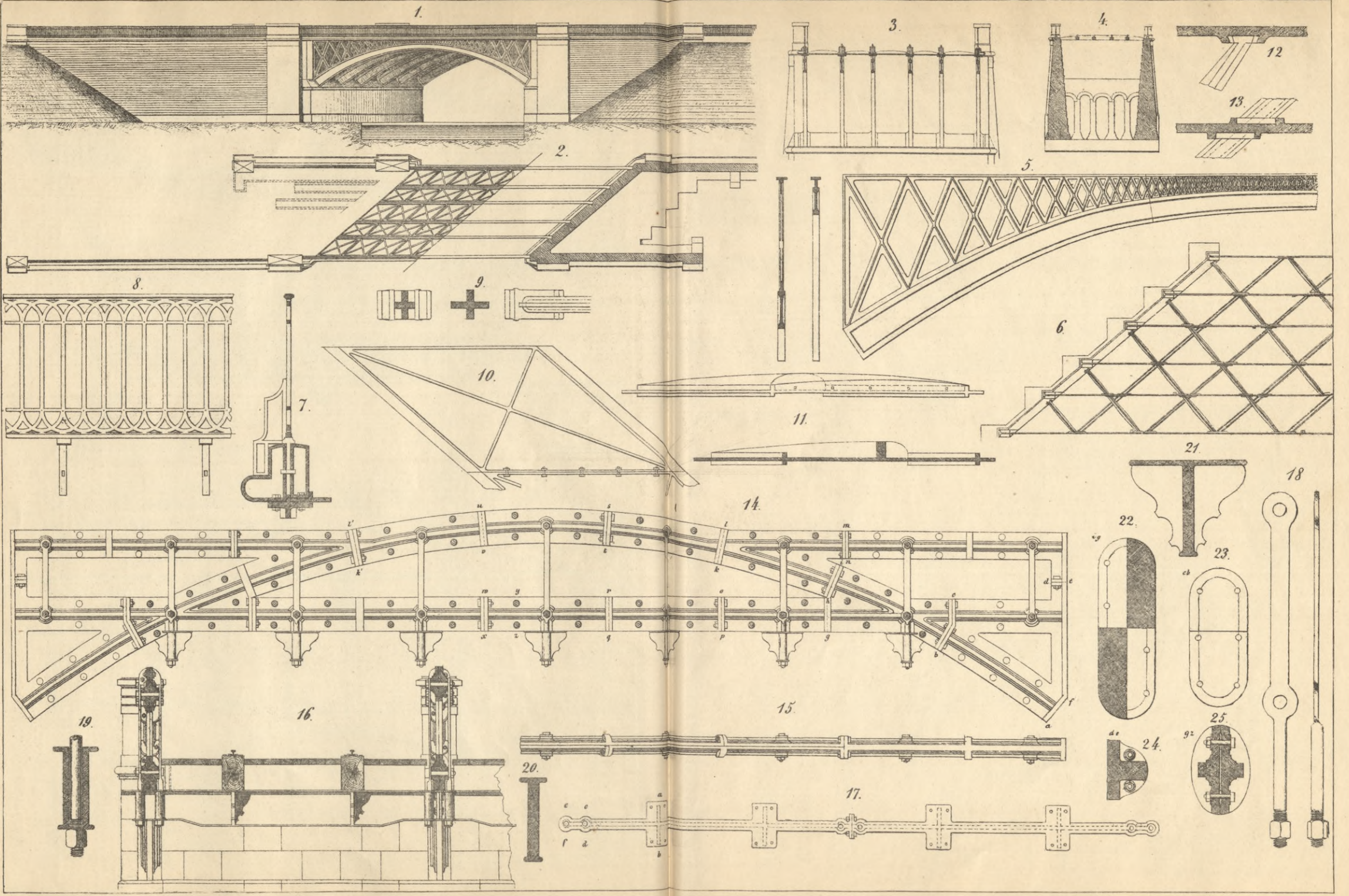

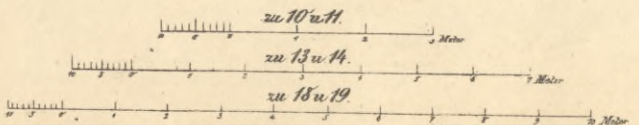
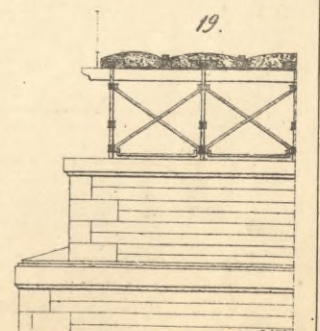
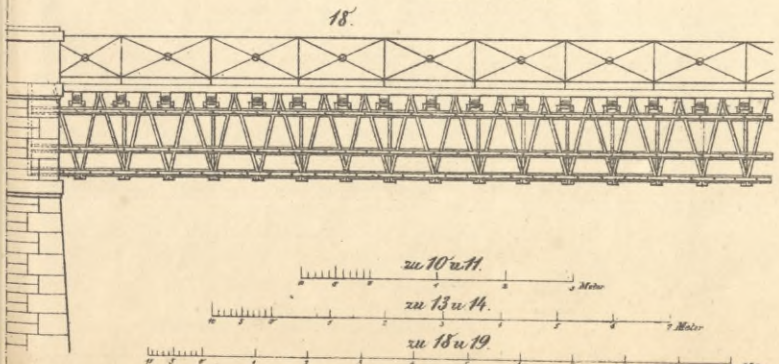
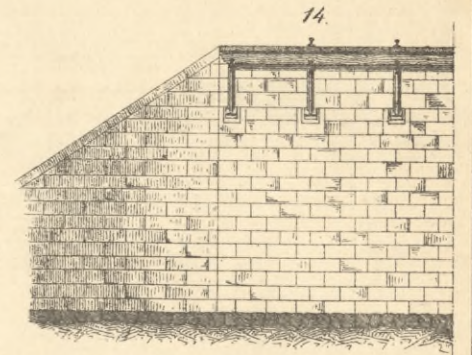
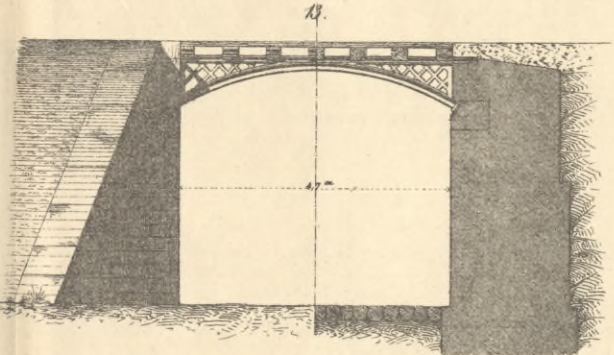
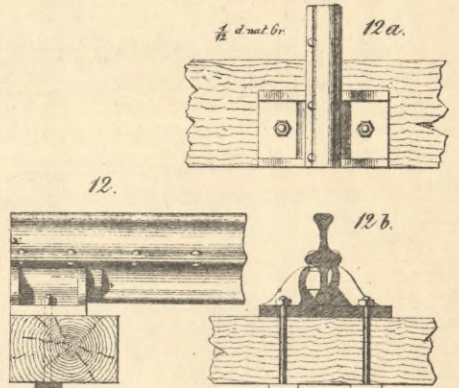
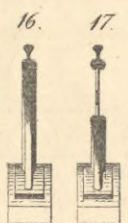
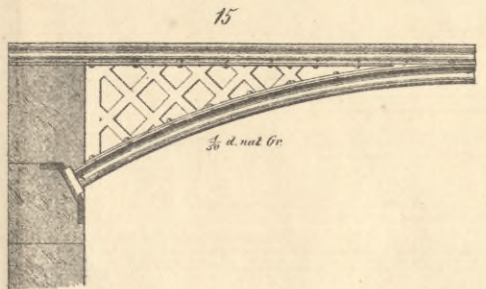
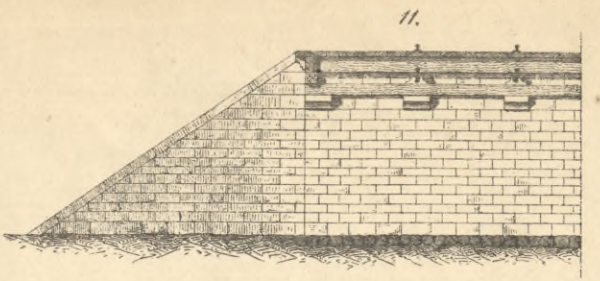
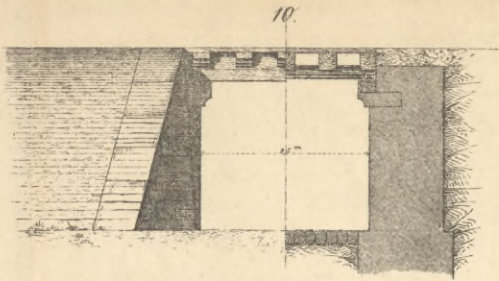
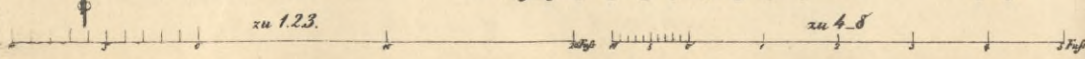
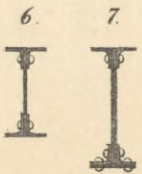
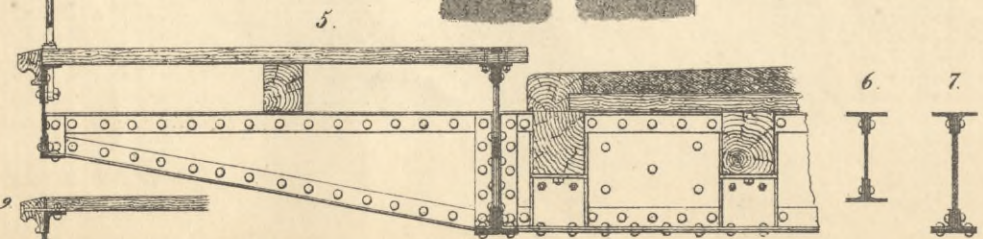
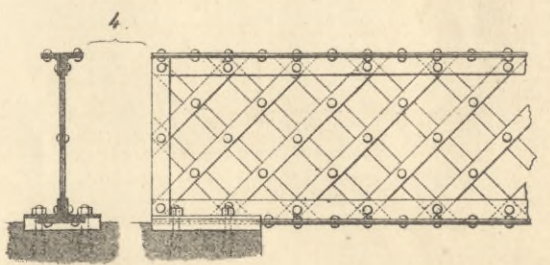
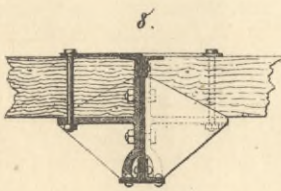
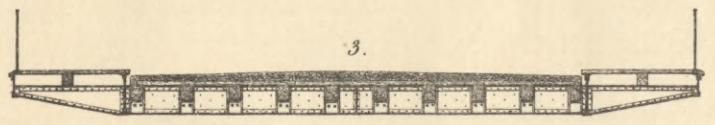
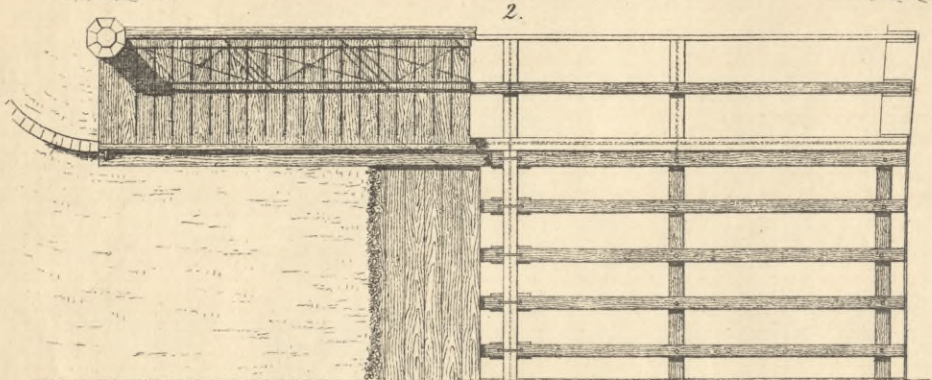
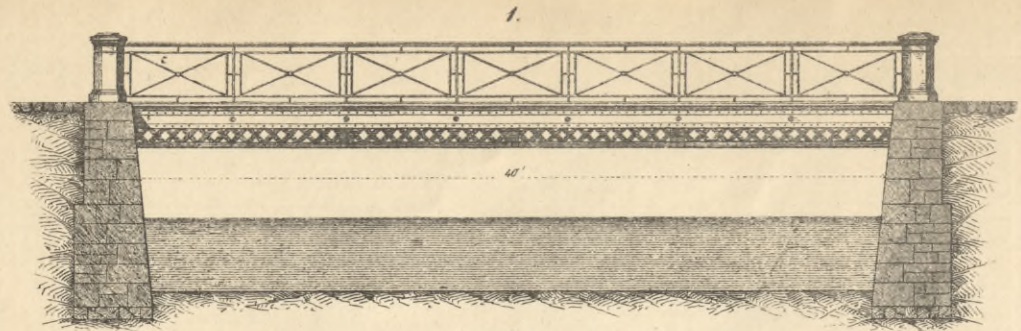

Schiefer Eisenbahn Viaduct von 20' Lichtweite
1. Ansicht

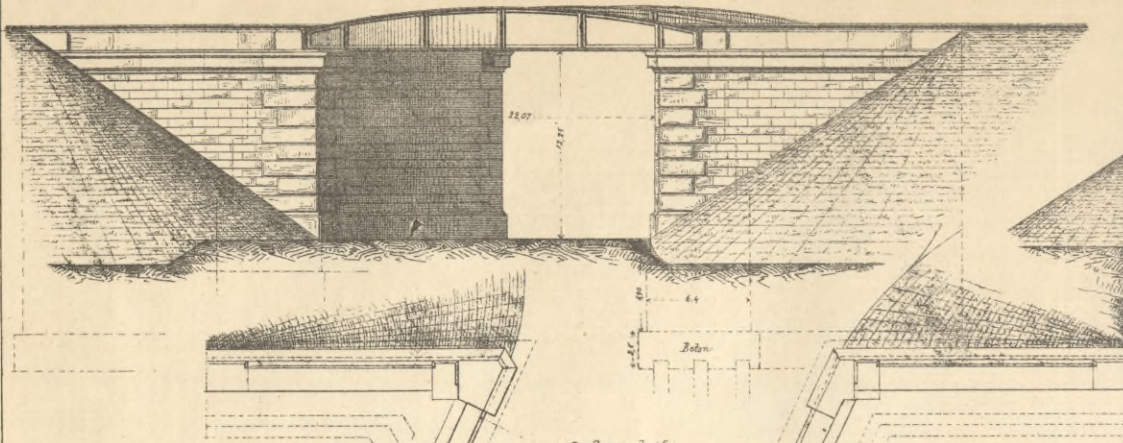

Barrenbrücken aus gewalztem Eisen
(Meckesheim-Jaxtfelder Eisenbahn)

9 Querschnitt in der Axe

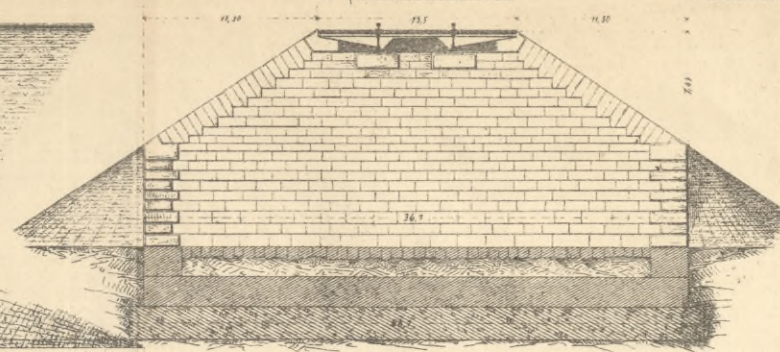

Winkelrechte Durchfahrt für einspurigen Eisenbahndamm
12' Lichtweite

Langenschnitt 10. Ansicht

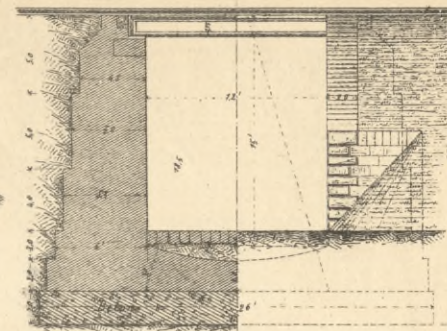

2. Grundriss

12. Träger-Detail

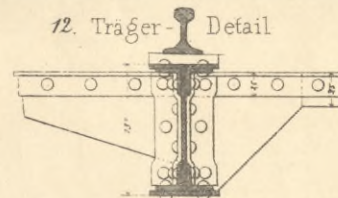

11. Grundriss

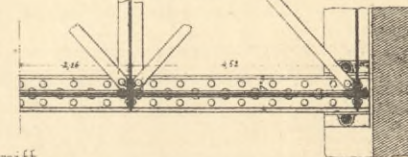

3. Querschnitt

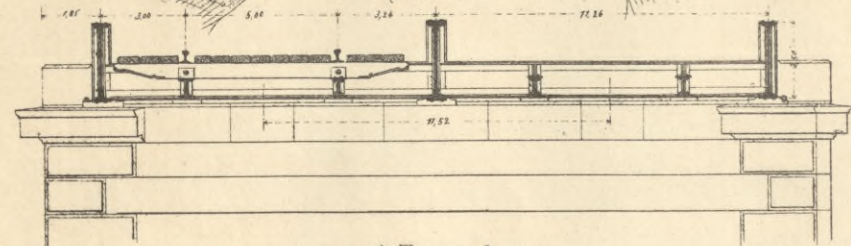

15. Langenschnitt

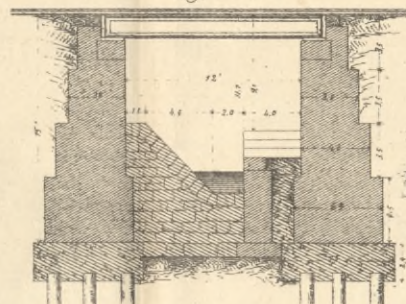

13. Querschnitt

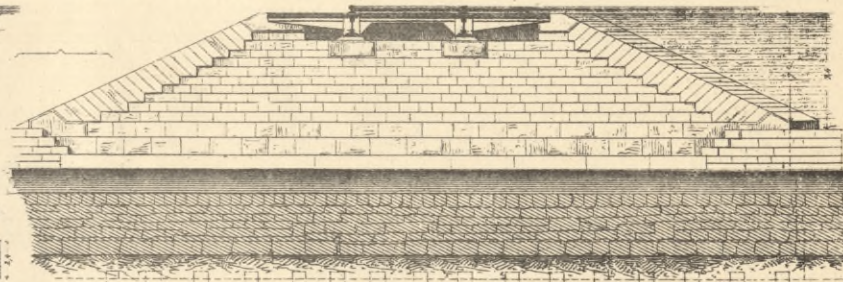

16. Querschnitt des Oberbaues

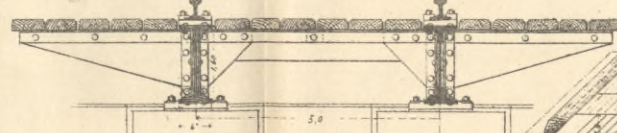

Schiefer Eisenbahndurchlaß 12' norm Lichtweite

14. Grundriss

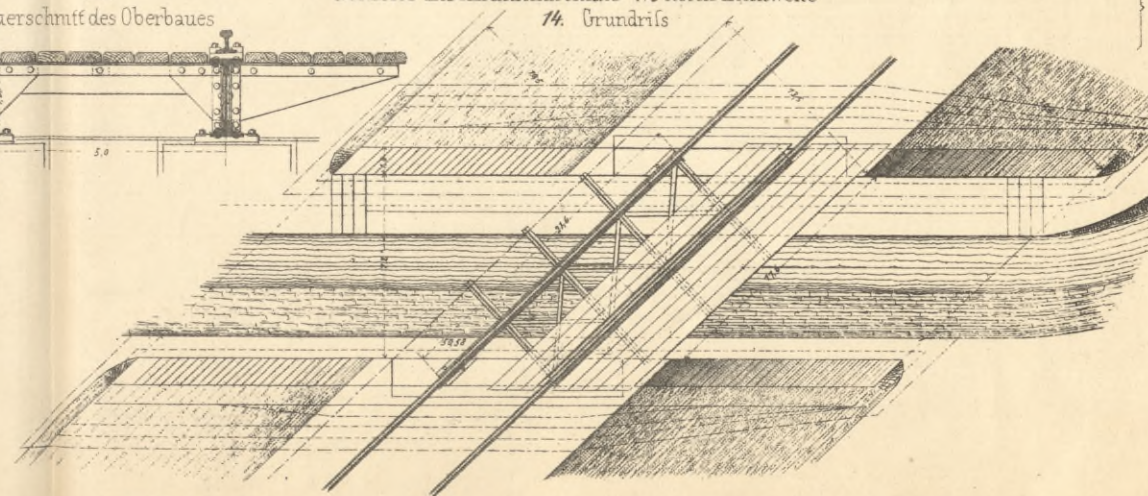

4. Tragwand

5. Querschnitt des Trägers

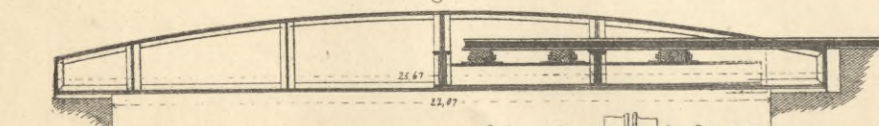

8. Äußere Verticalabsteifung
7. Schwellen-(Längs)Träger

6. Querschnitt des Querträgers

Maasstab - 1/32 zu 5-8 u 12.

Maasstab - 1/80 zu 1 2 9 10 13 14 15.

Maasstab - 1/32 zu 3 u 4.

Maasstab - 1/32 zu 11 u 16.

1. Brücke über die Pfaffern bei Niederwyl

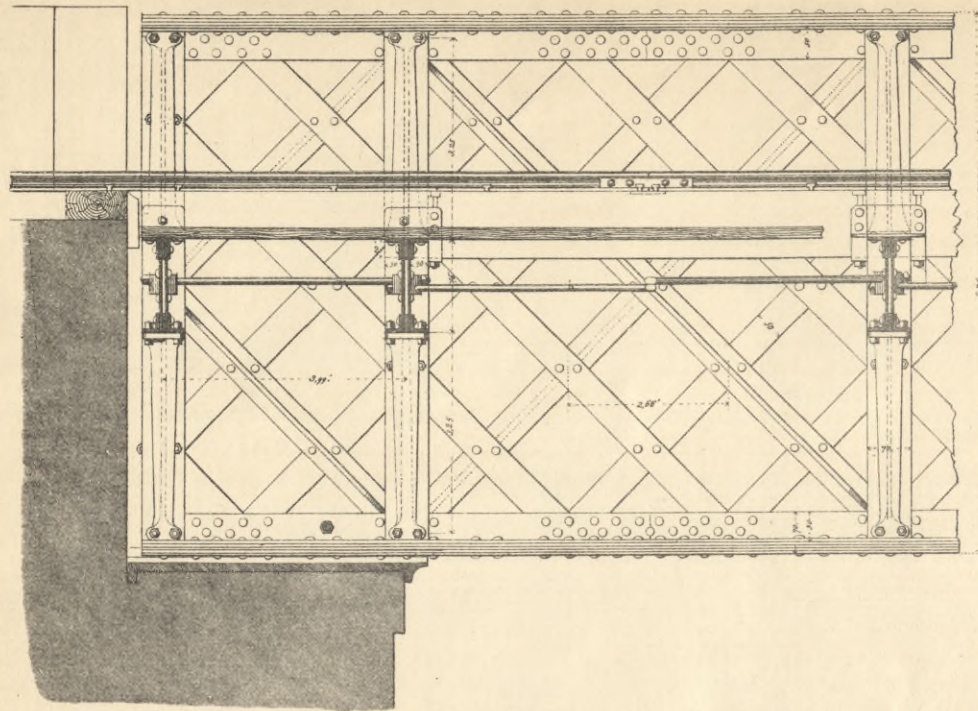

Brücke über die große Emme bei Burgdorf

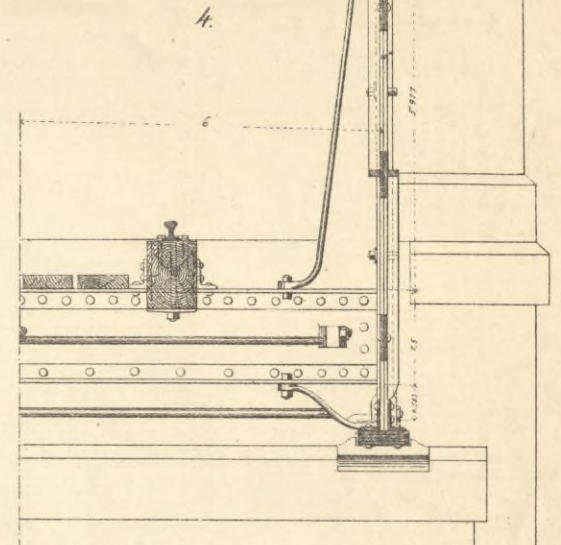
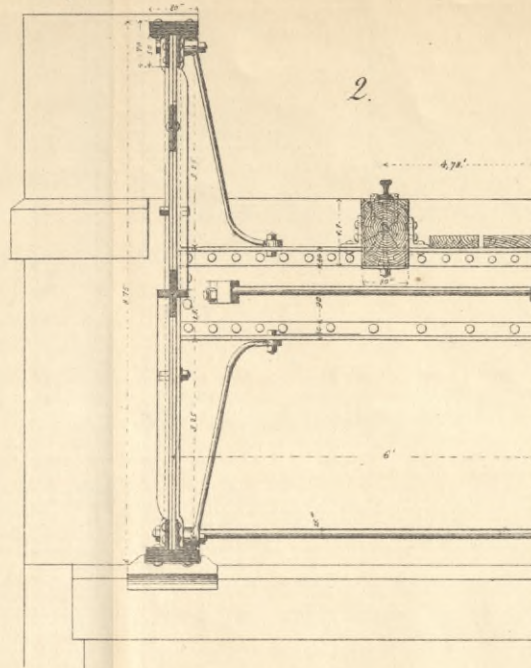

5. Brücke über die Aare bei Bern

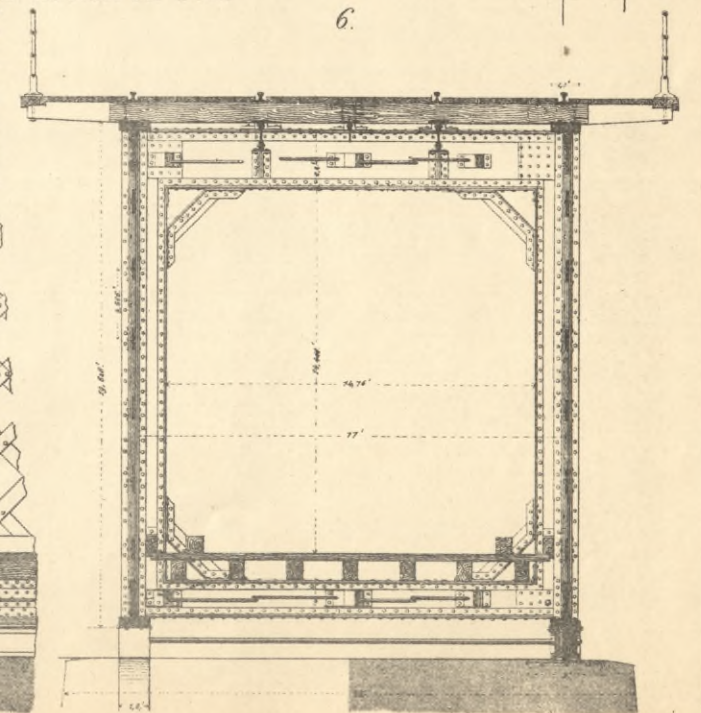
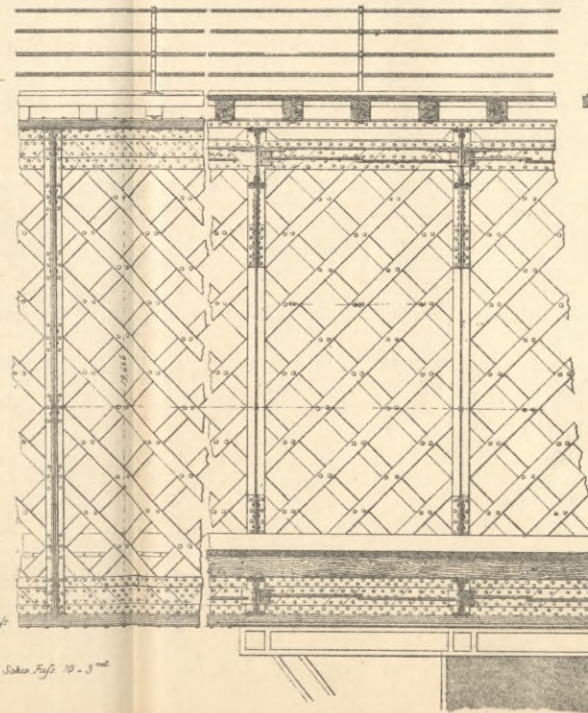

3.

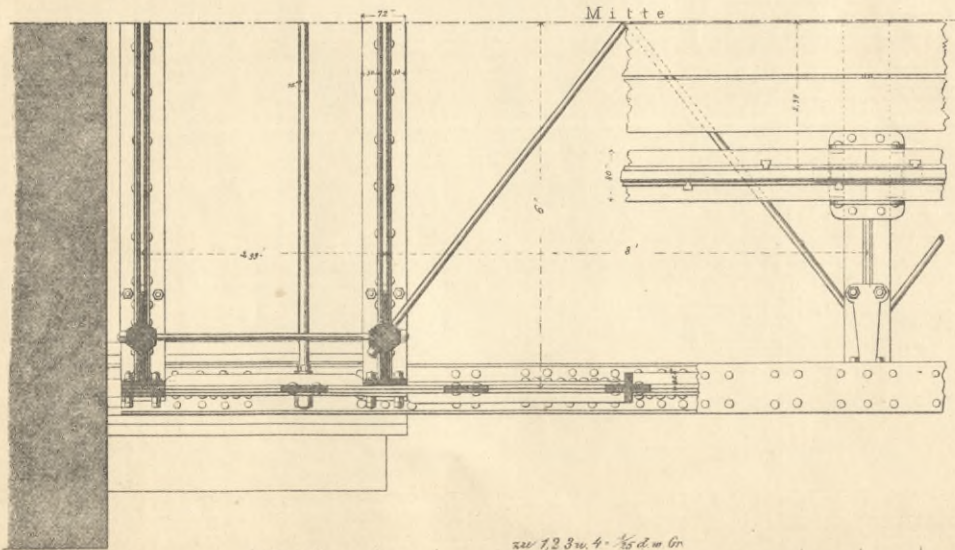

Mitte
zur 1, 2, 3 u. 4 - 1/2 d. in Gr.
zur 5 u. 6 - 2/3 d. in Gr.
10 Sek. Fuß.
10 Sek. Fuß. 10 - 5"

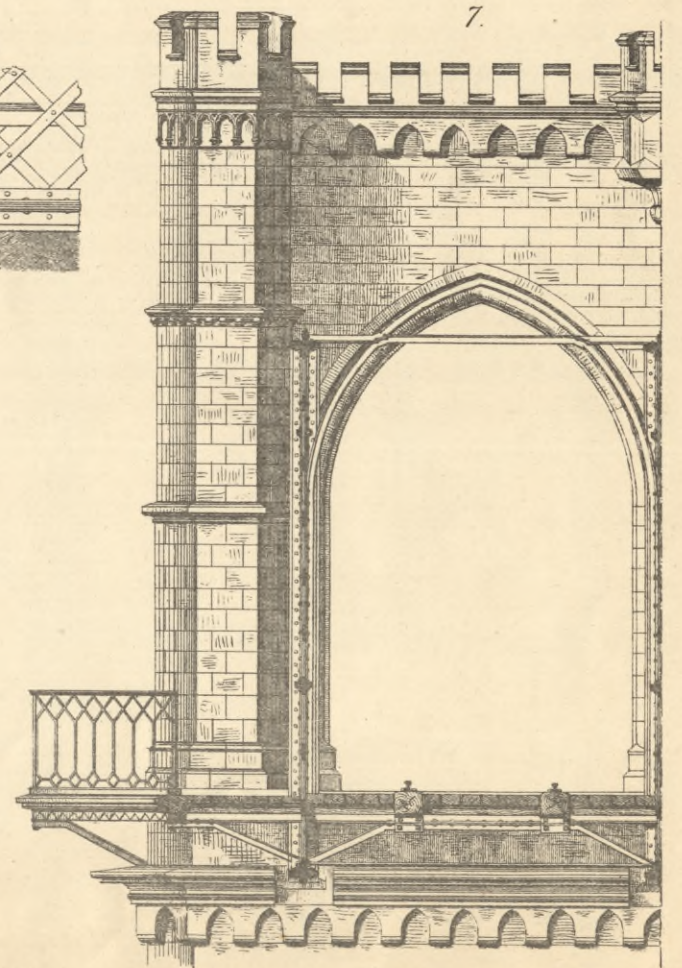
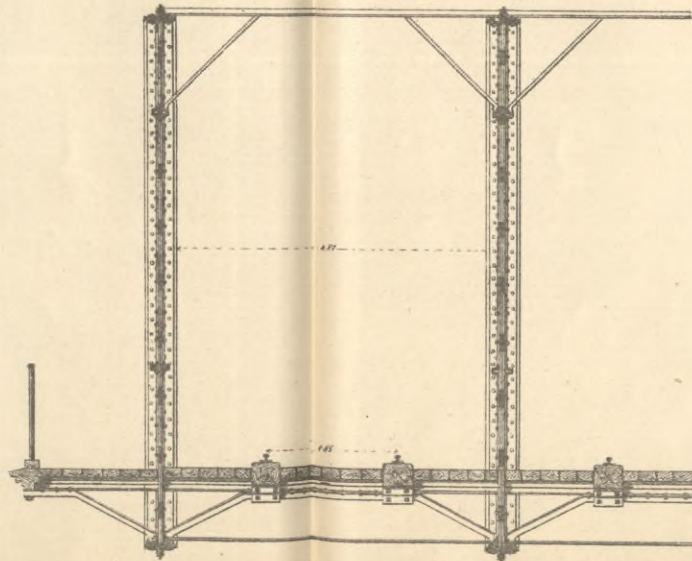
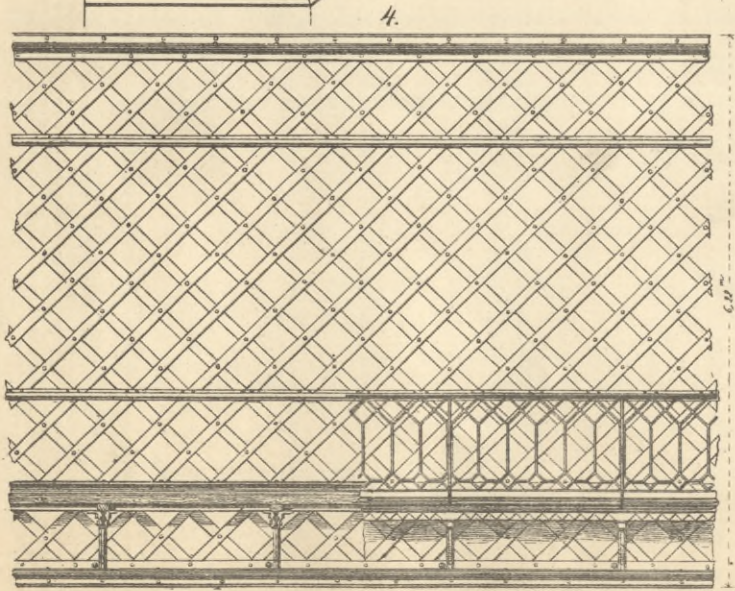
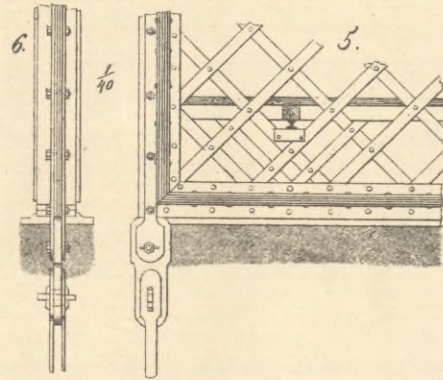
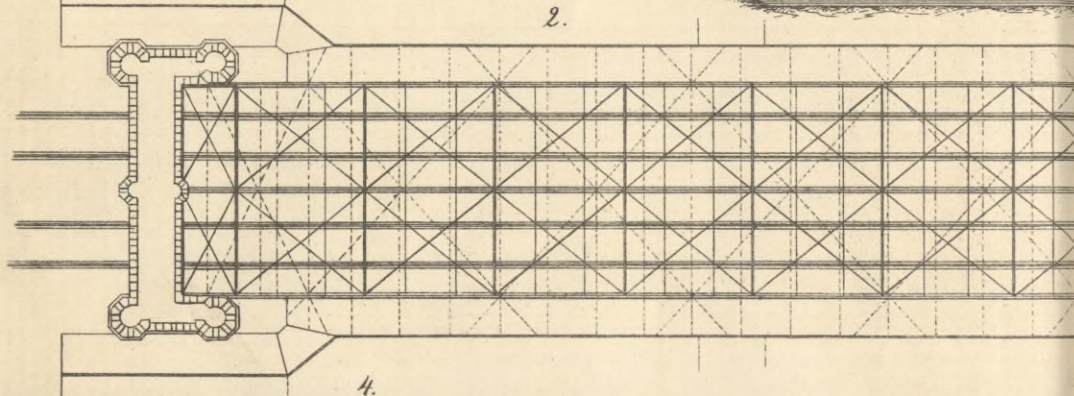
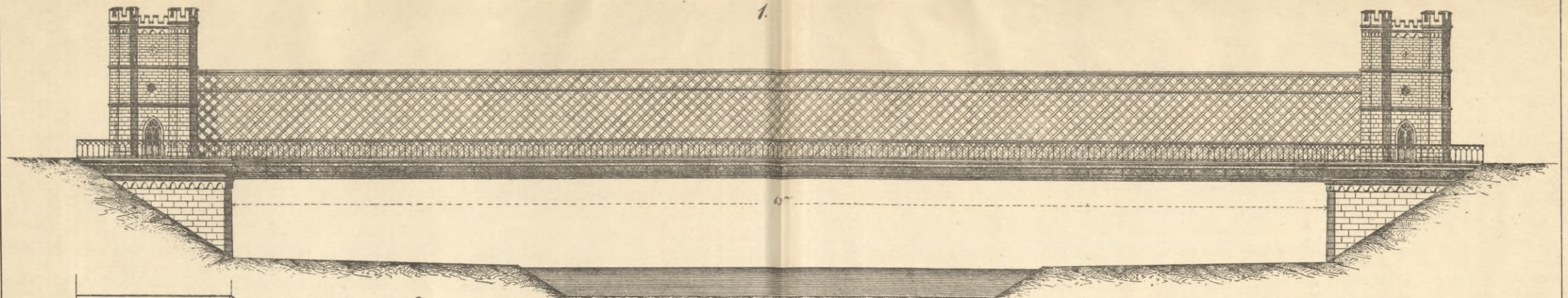

zu 1 u. 2.

50 Meter

zu 3, 4 u. 7.

1 Meter

Eisenbahn-Viaduct über die Saane bei Freiburg (Schweiz)

1. Ansicht

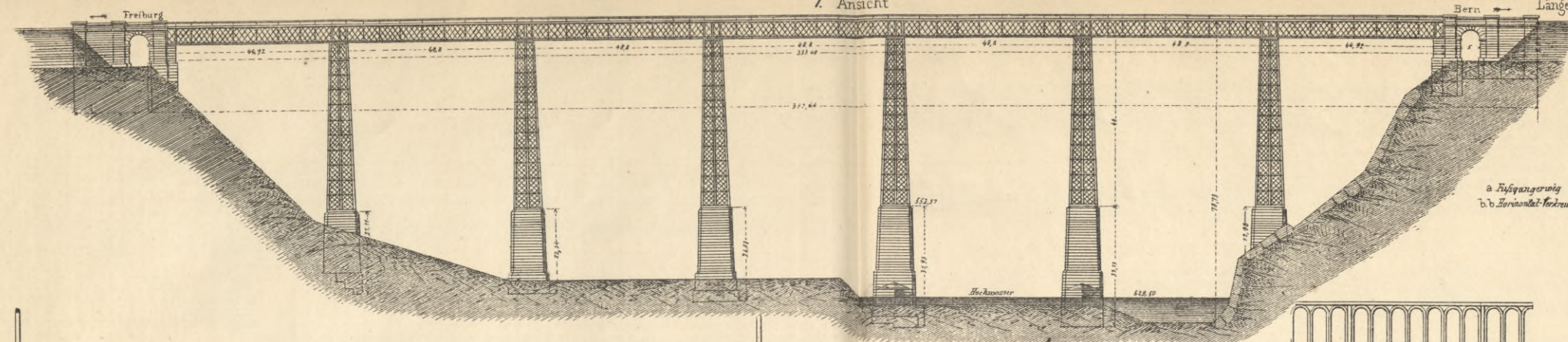

2. Längenschnitt eines Pfeilers

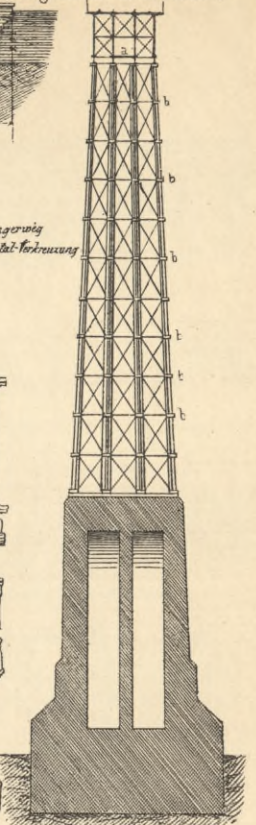

3. Querschnitt

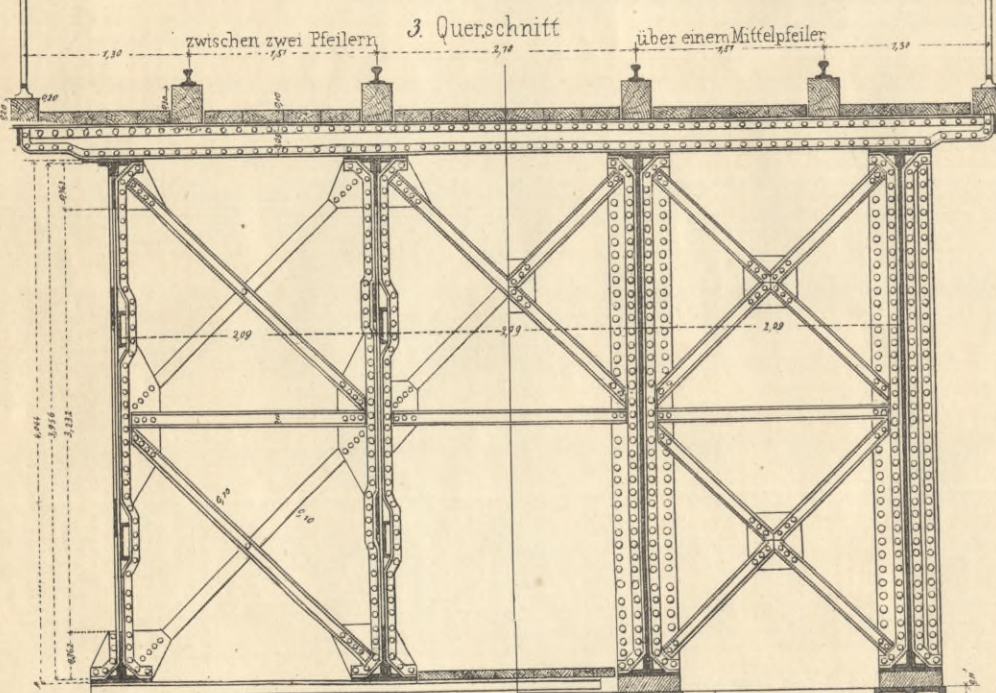

4. Längenschnitt

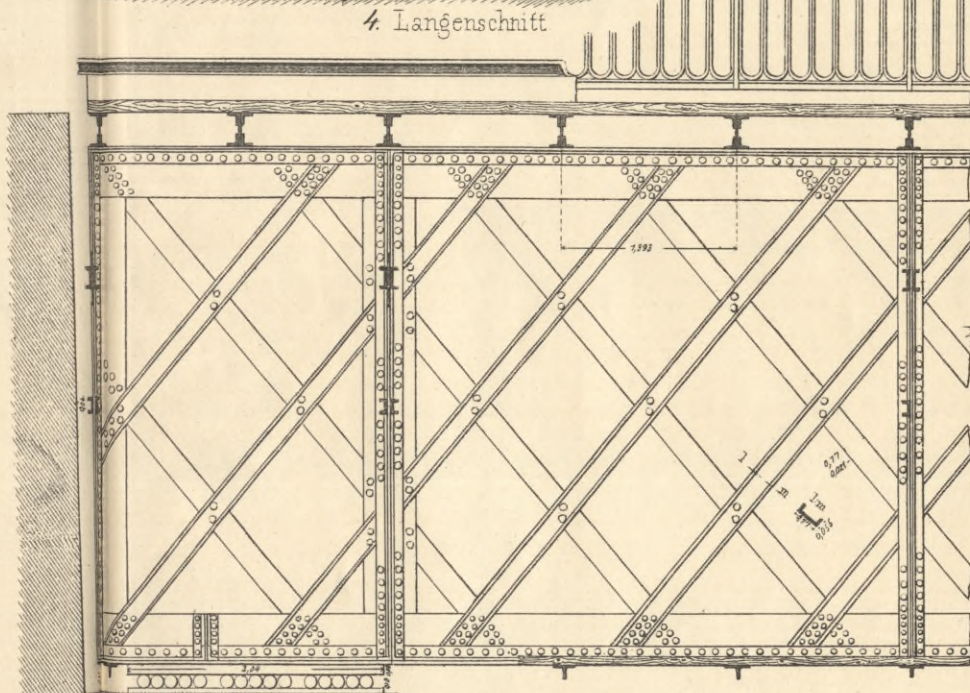

5. Untere Gurtung u. Vertical-Absteifungen

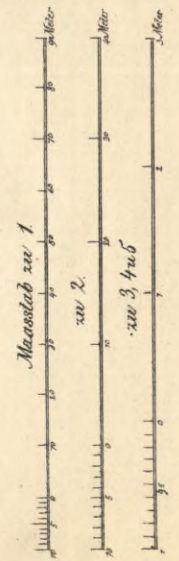
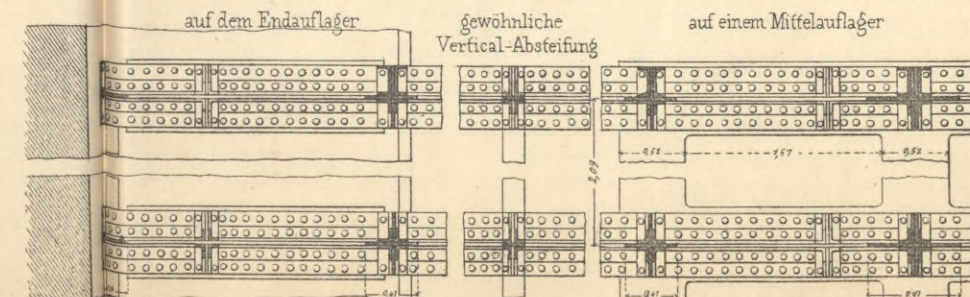

RHEINBRÜCKE ZWISCHEN MANNHEIM UND LUDWIGSHAFEN

Ansicht
1:1000

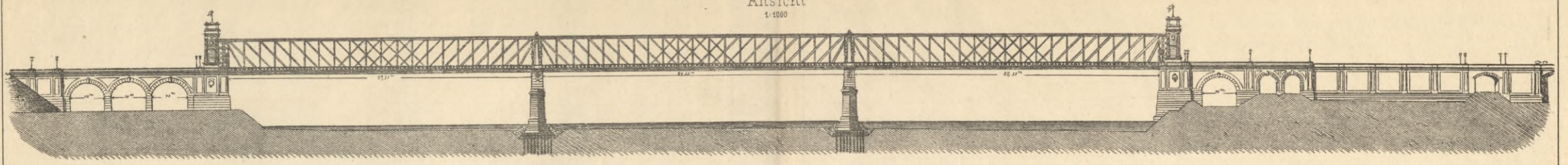

Grundriß 1:1000

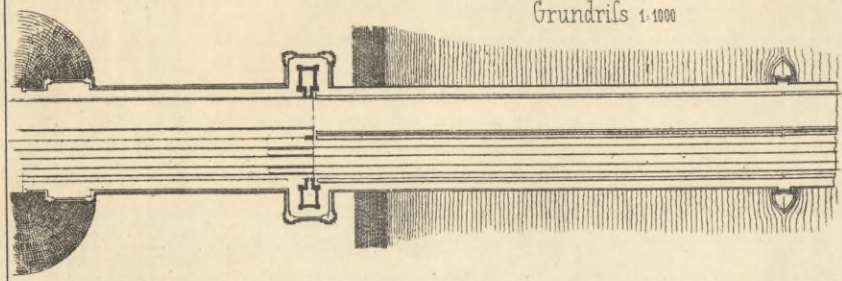

Ansicht eines Straßenbrückenträgers 1:200

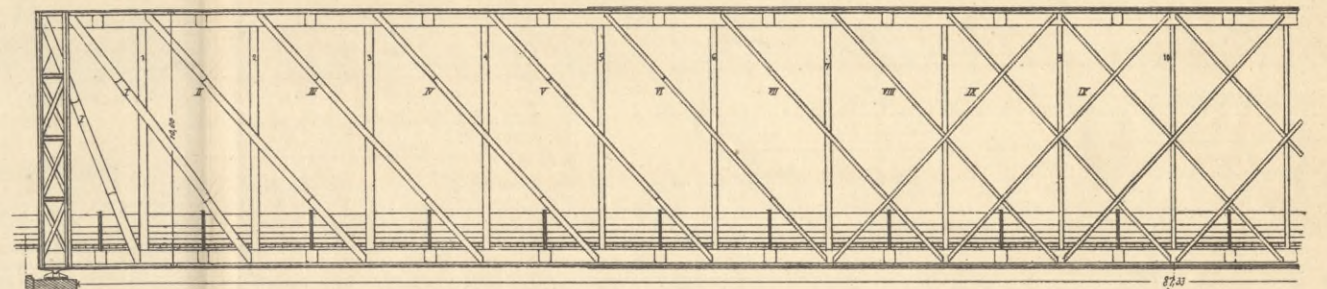

Ansicht eines Eisenbahnbrückenträgers

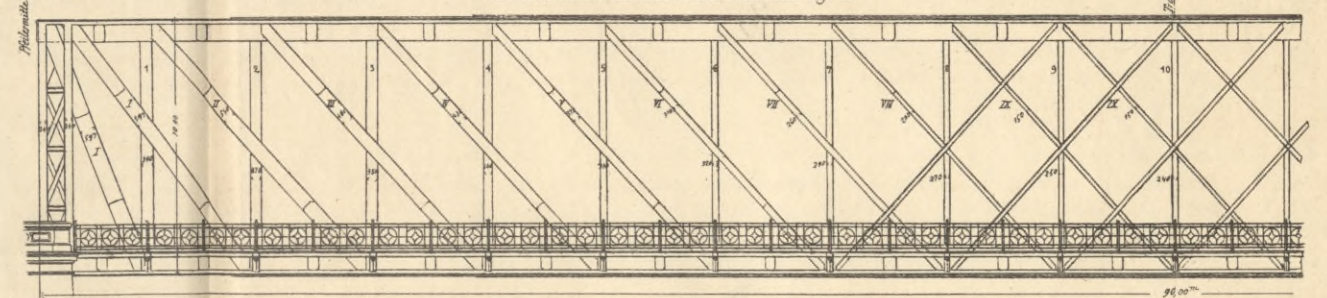

Querschnitt
1:75

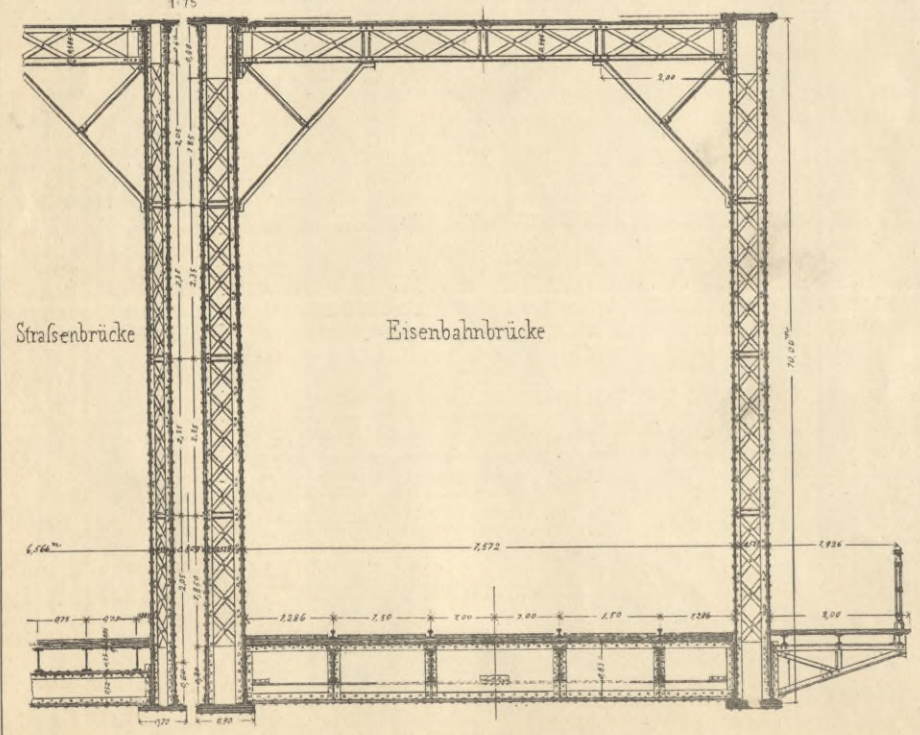

Grundriß der Eisenbahn- und Straßenbrücke

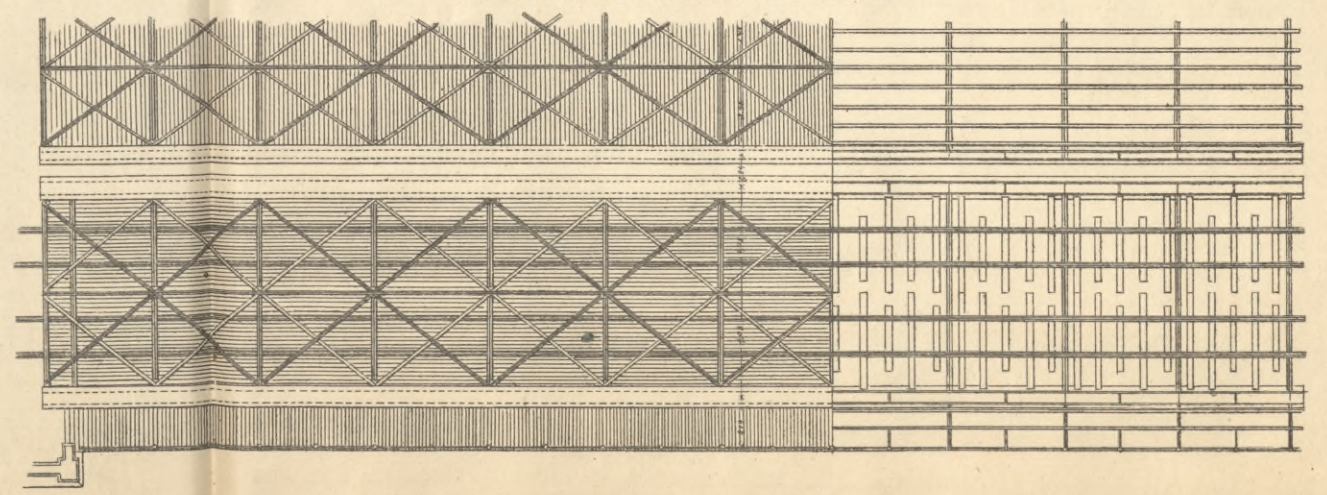

Maasstab - 1:1000 d.w. Gr.

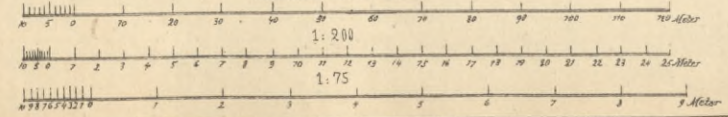

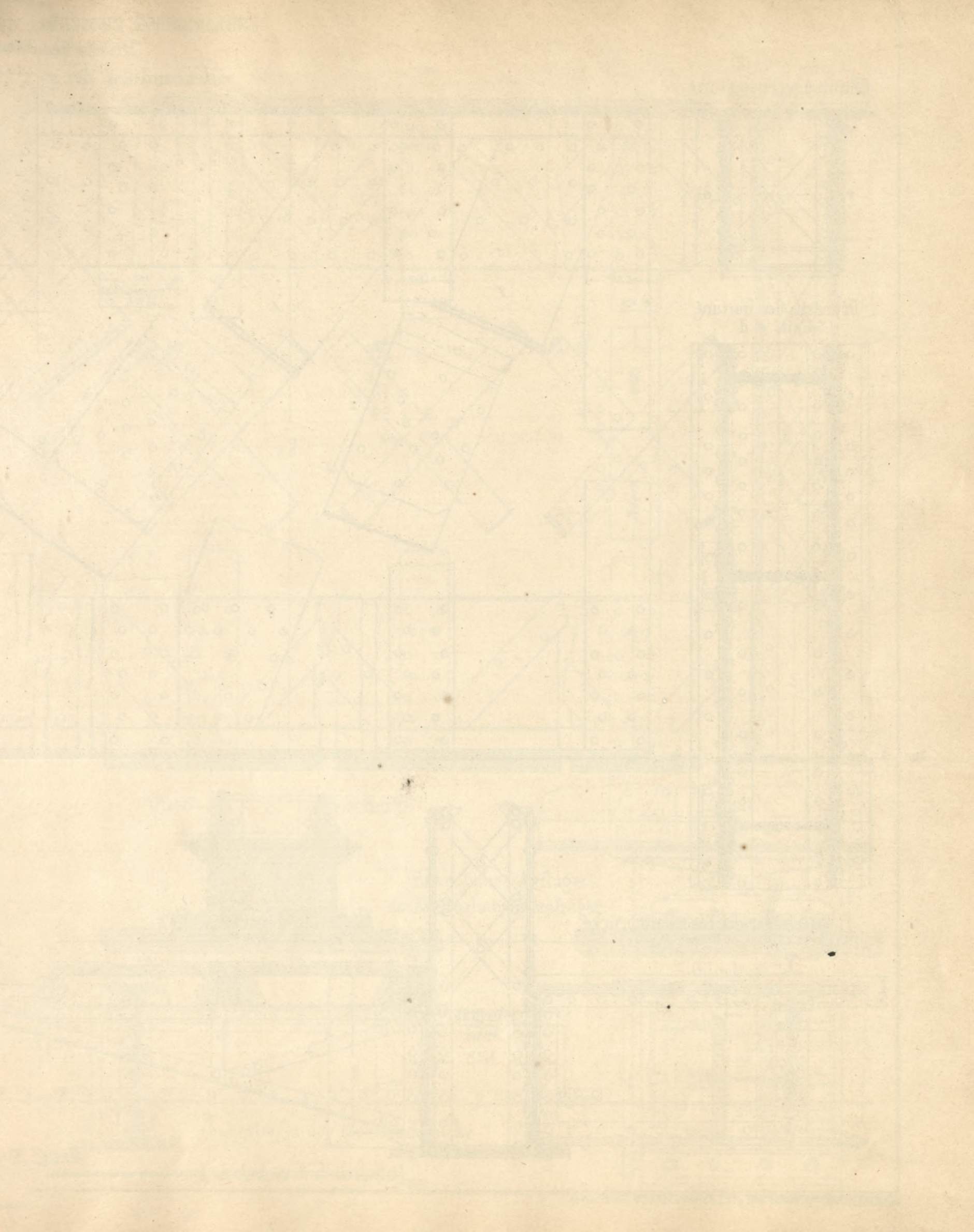

RHEINBRÜCKE ZWISCHEN MANNHEIM UND LUDWIGSHAFEN

Details der Eisenbahnbrücke

Verbindung der Zugbänder mit den Gurtungen

Schnitt a b der Gurtung

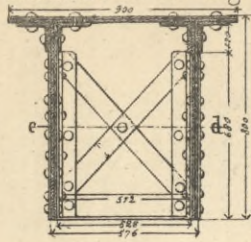

Grundriß der Gurtung
Schnitt c d

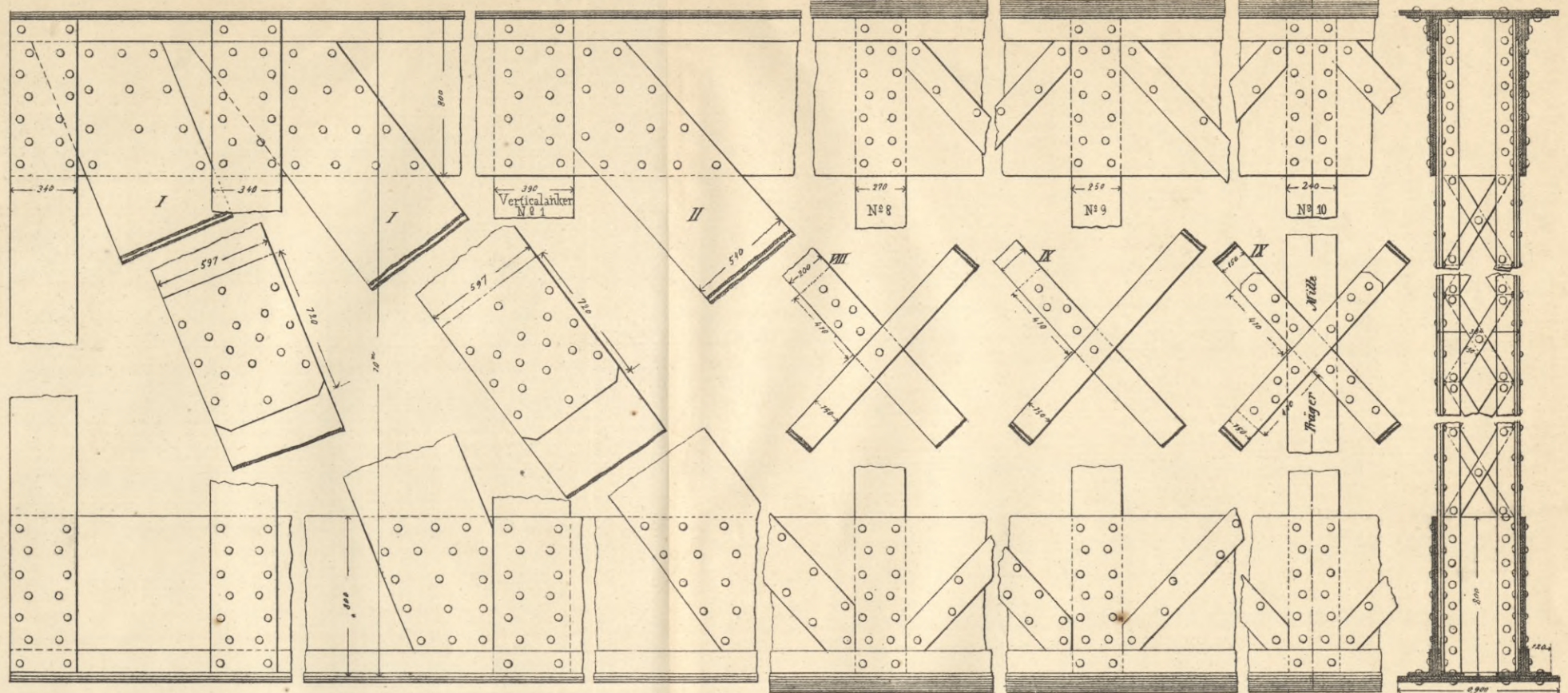
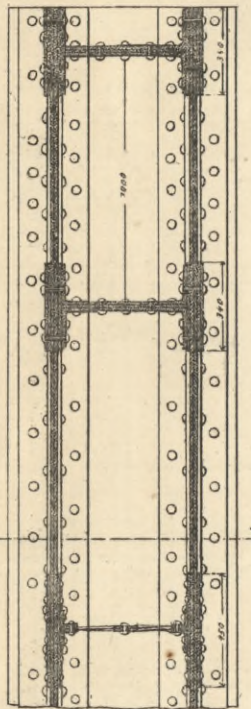

Verticalanker N^o 1

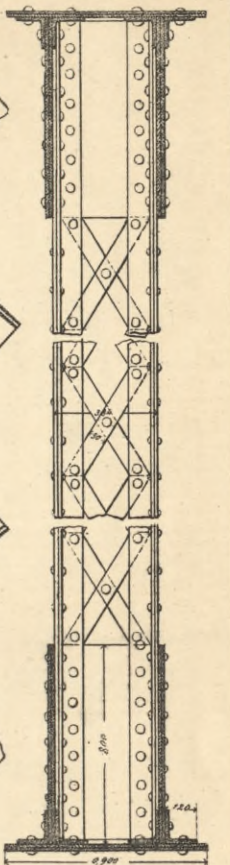

Quer - Schnitt

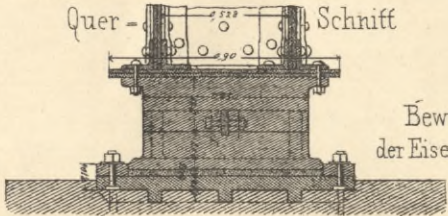

Bewegliches Auflager
der Eisenbahnbrückenträger

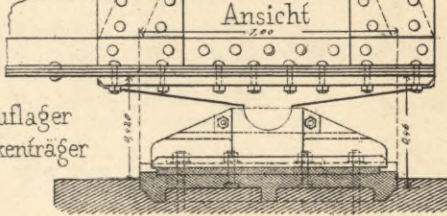

Grundriß

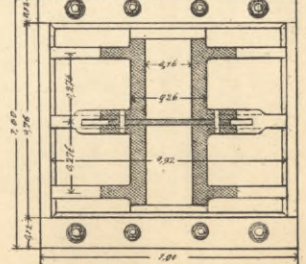

Querträger der Eisenbahnbrücke

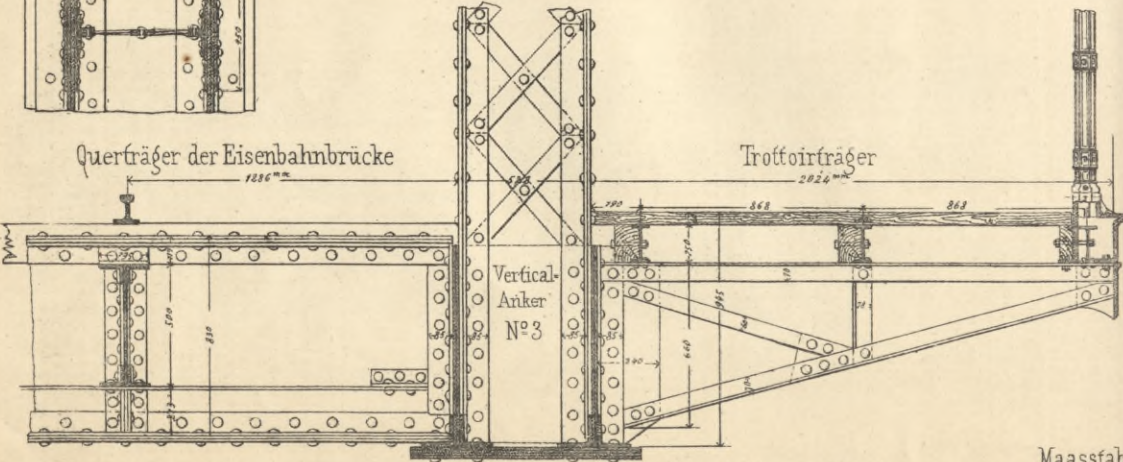

Trottoirträger

Langträger der Eisenbahnbrücke

Maasstab 1:20 d.w.Gr.

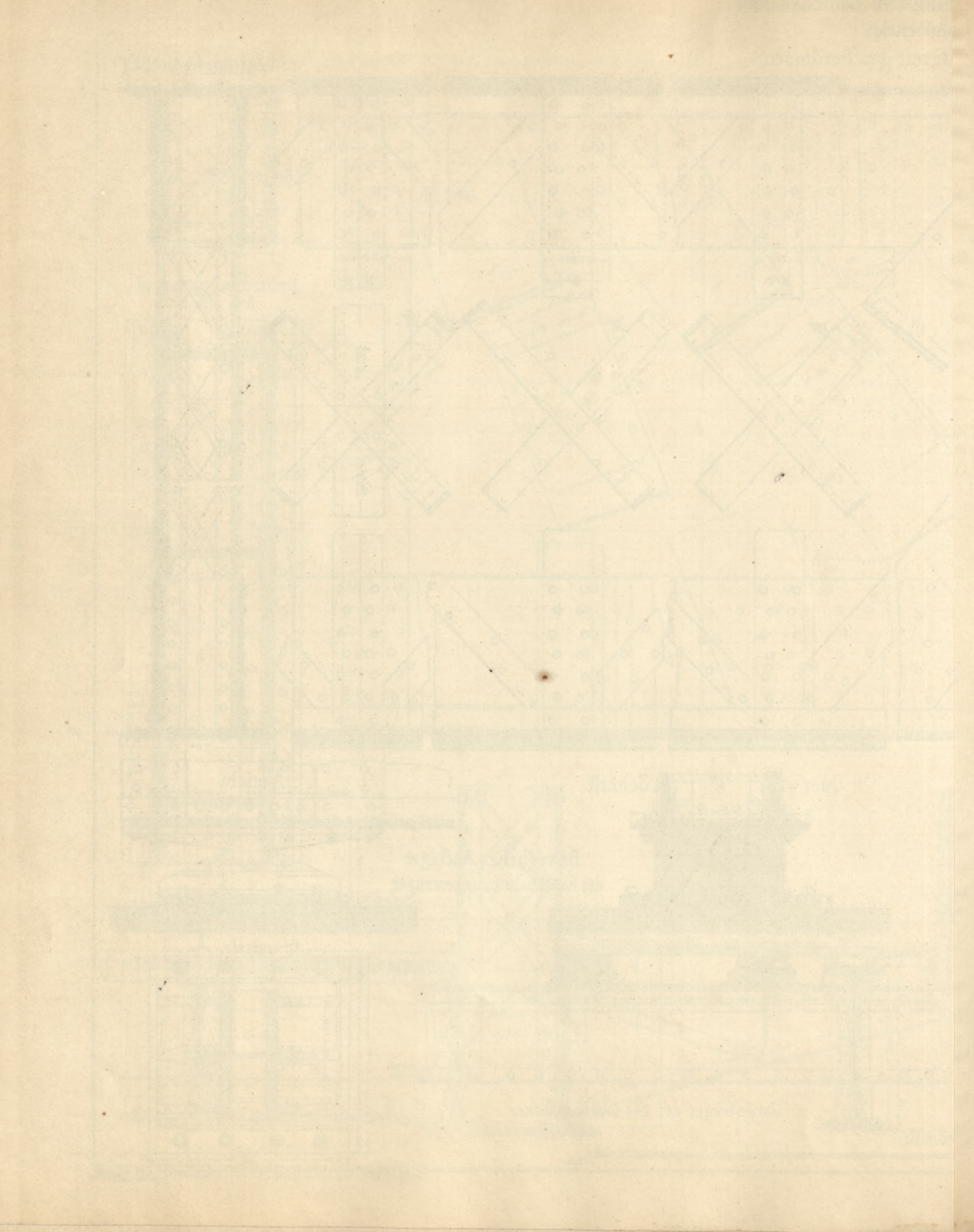

Brücke über die Weser bei Corvey in der Altenbeken Holzinider Eisenbahn

Entworfen von H. Baurath Schwedler

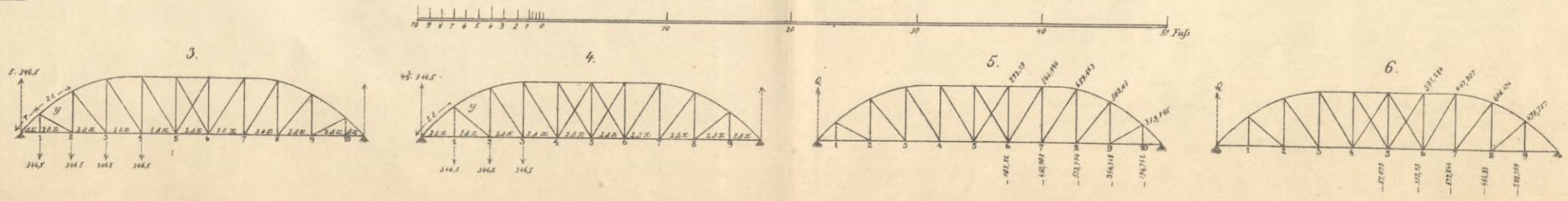
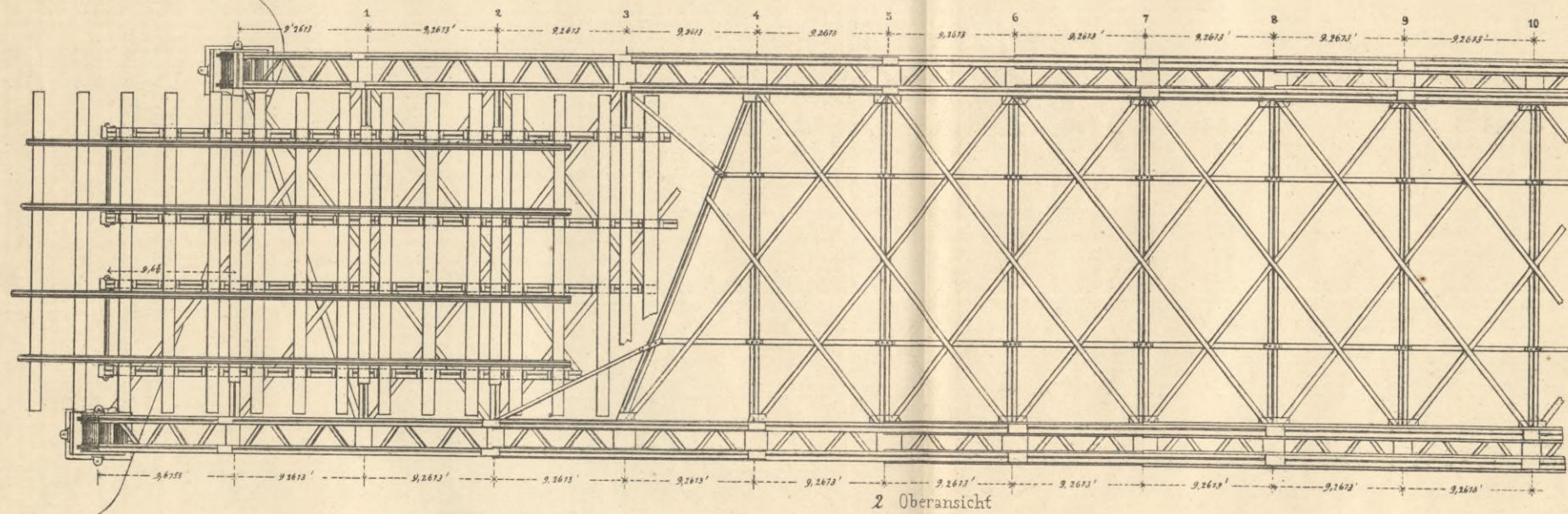
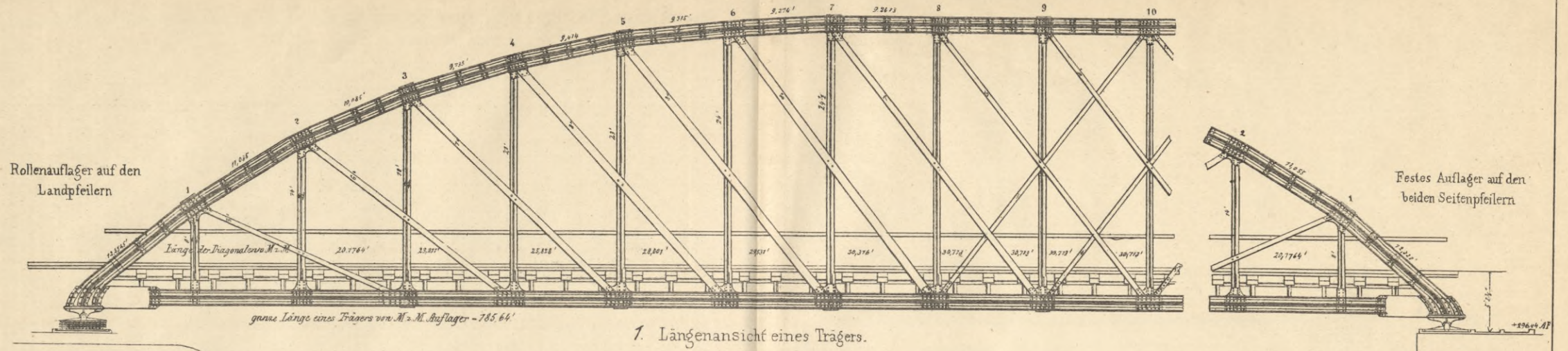

Jsarbrücke bei Großhesele (System Pauli)

1 Ansicht

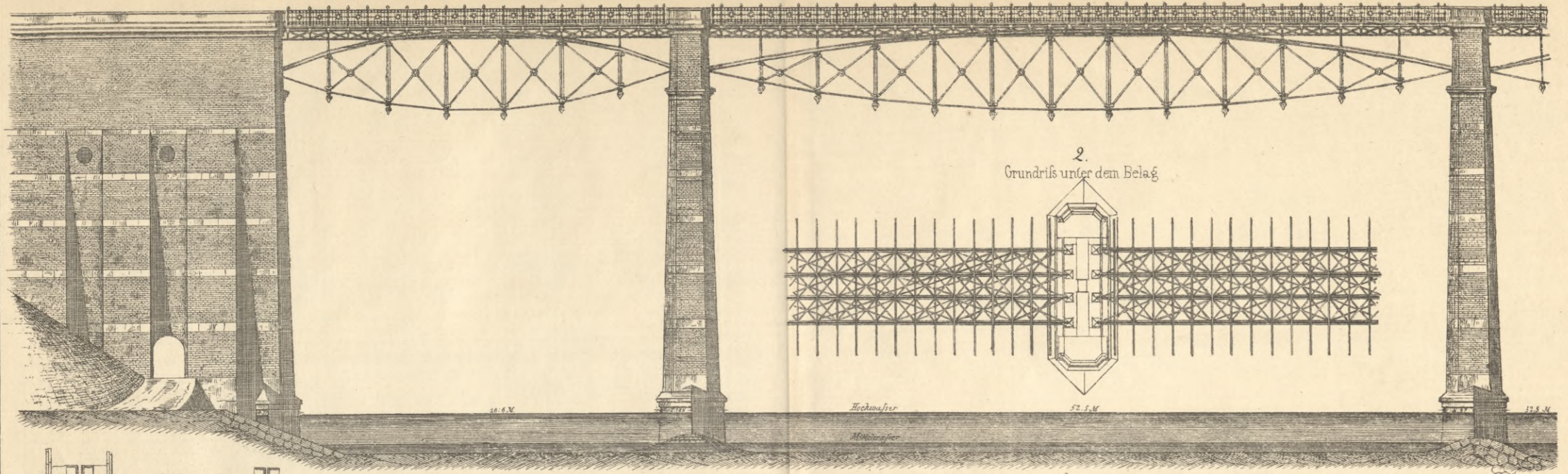

2 Grundriß unter dem Belaß

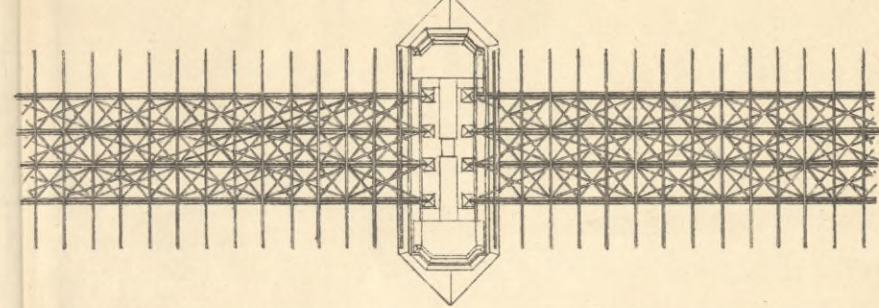

3 Querschnitt in der Mitte einer großen Öffnung
Gegenwärtige Lage Künftige Lage bei Ausführung der Doppelbahn

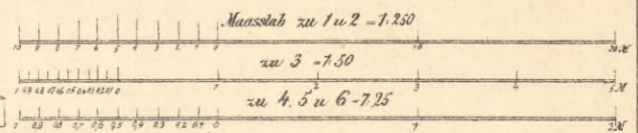
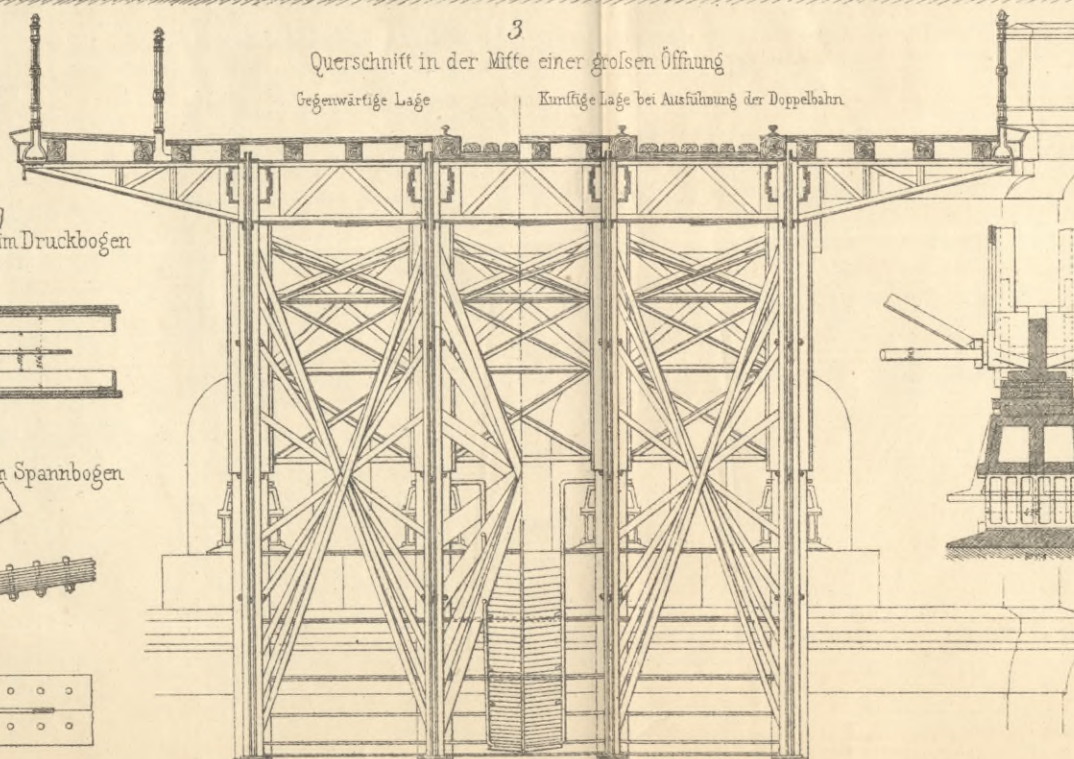

4 Beweglicher und fester Stuhl mit Bogenschuh
Öffnung mit 54^{te} Lichtweite

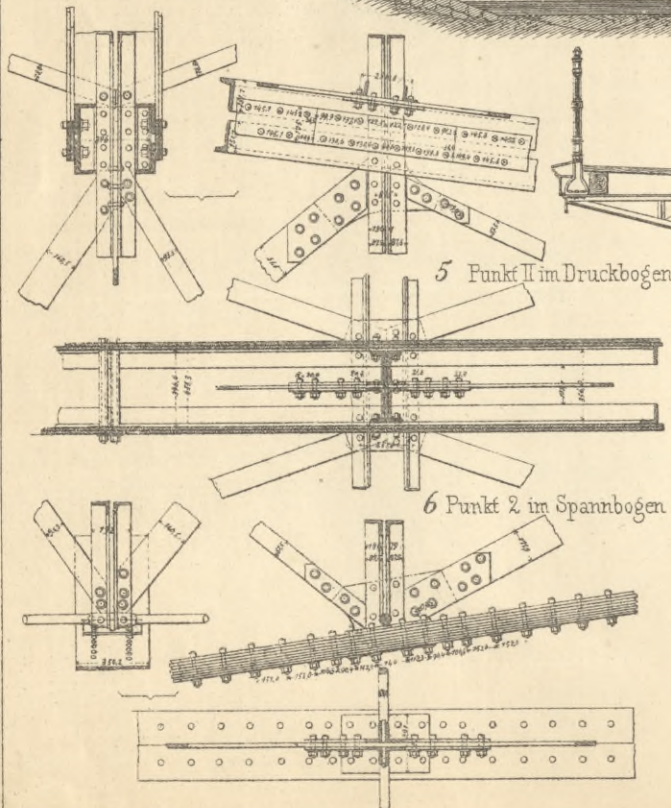
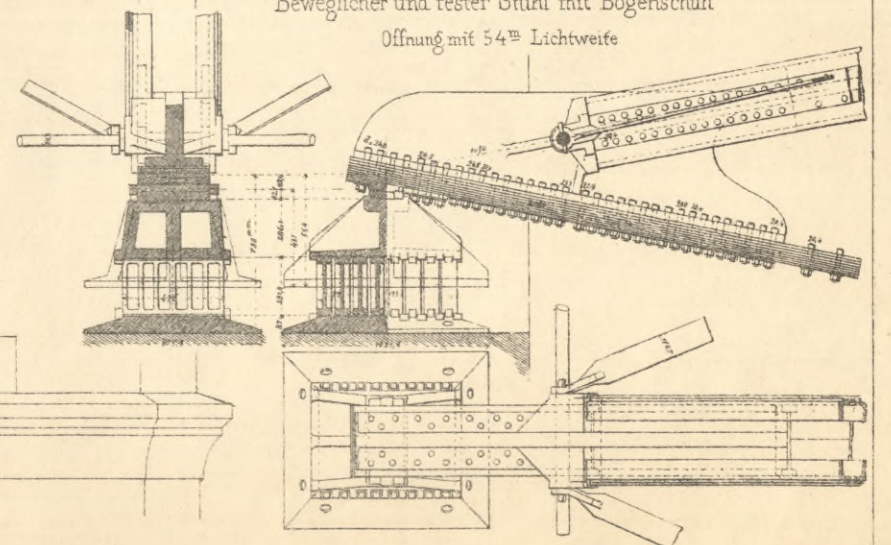

Brücke über die Ruhr bei Mülheim nach dem Entwurfe des H. Oberbaurath E. Hartwich

1. Seitenansicht nach Nord

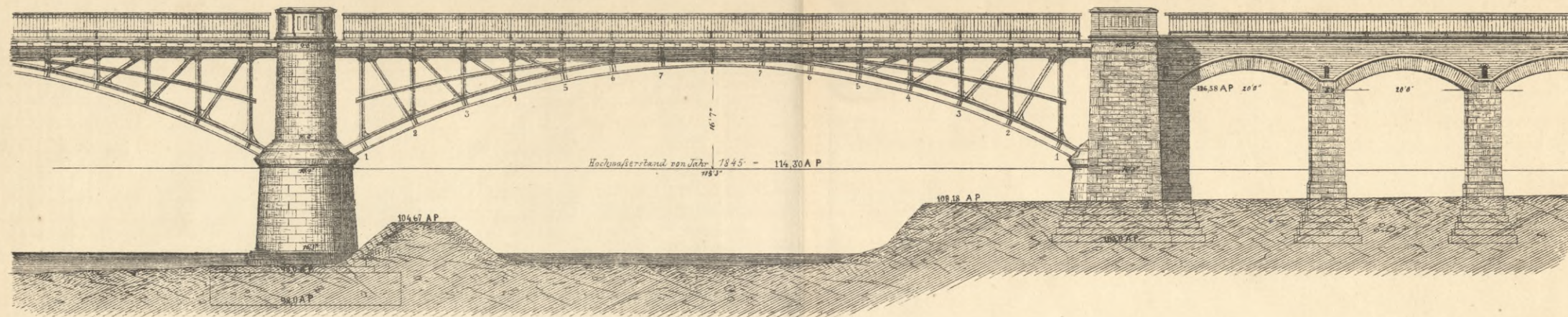

2. Grundriss

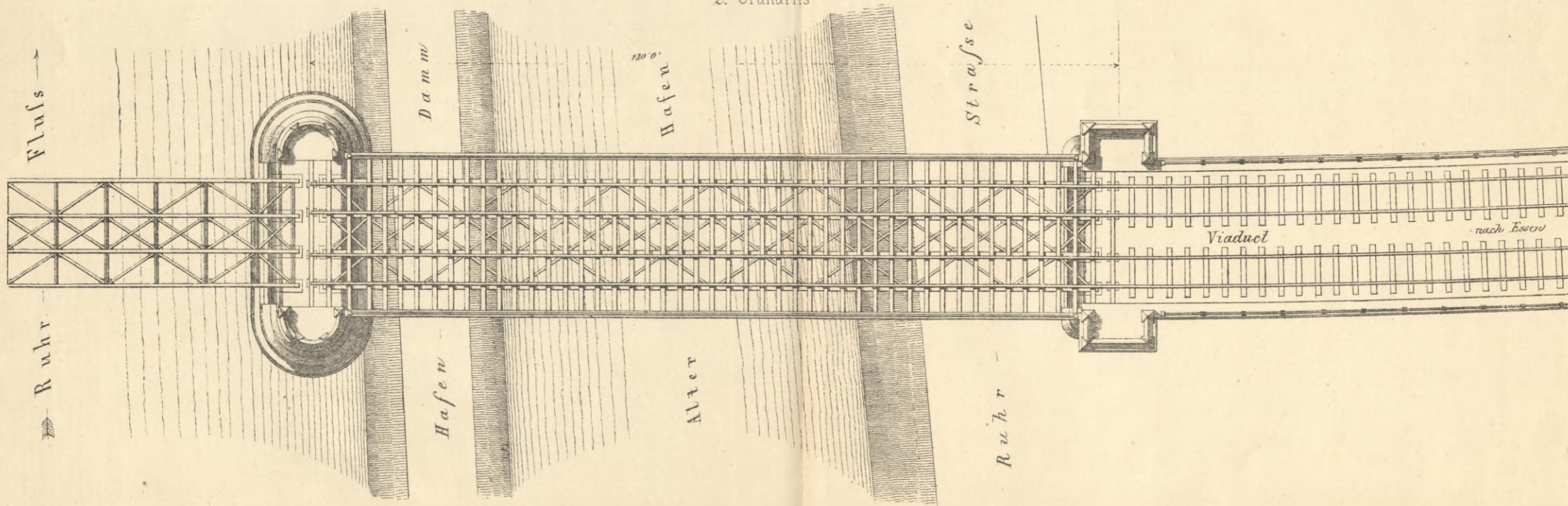

Maaßstab = $\frac{2}{3} - 10' = 1:180$ nat. Gr.

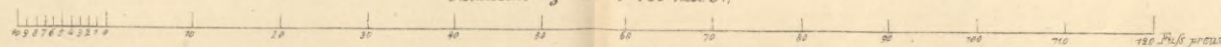

Faint, illegible text at the top of the page, possibly bleed-through from the reverse side.

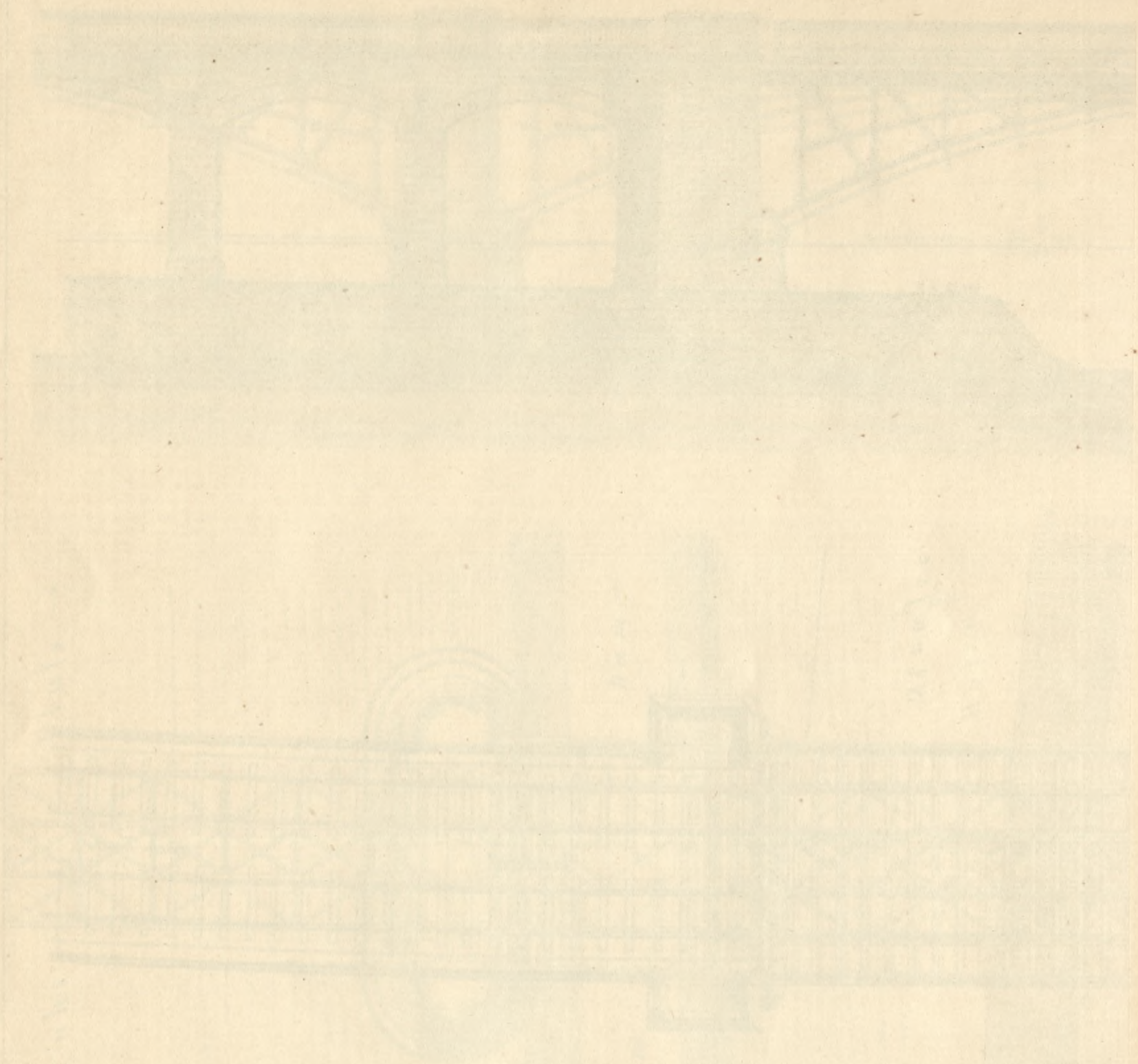

Brücke über die Ruhr bei Mülheim

1. Querschnitt in N^o 8

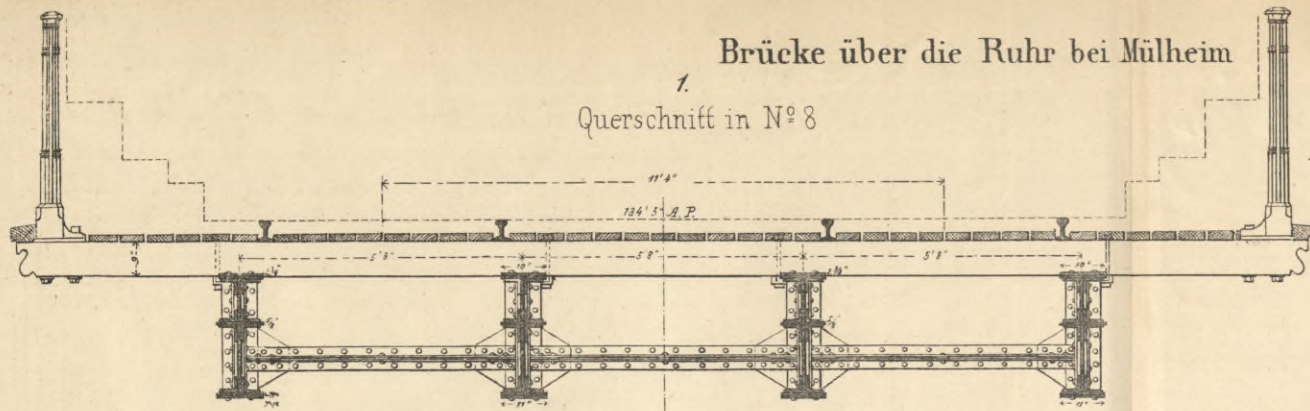

2. Querschnitt in N^o 1.

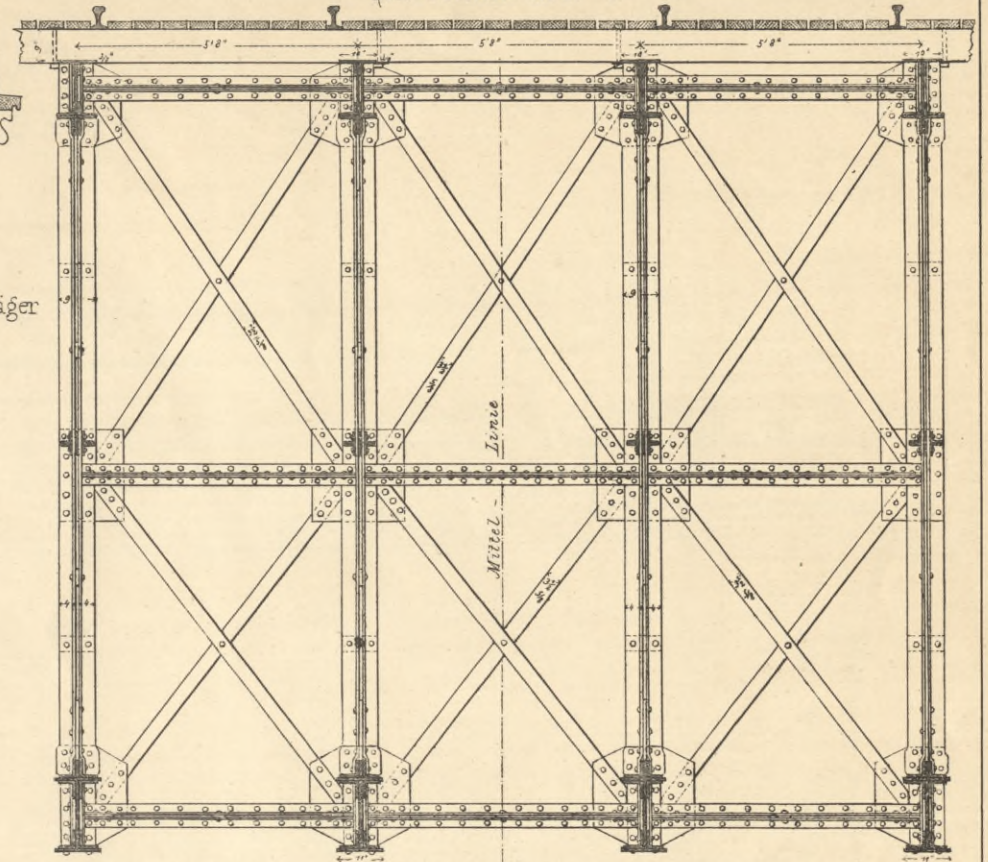

5. Auflager der obern Gurtung
Seitenansicht

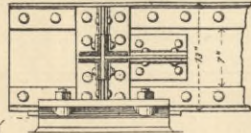

Querschnitt

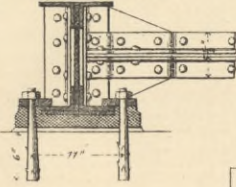

Anschlüsse der Querverbindungen an einen äußern Träger

a. in N^o 3 an der obern Gurtung

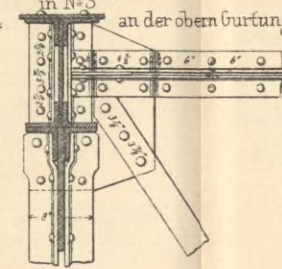

b. an der untern Gurtung

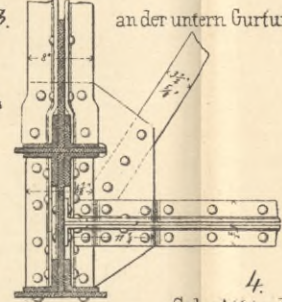

Grundriss

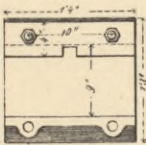

6. Widerlager und Bogenanfang eines äußern Trägers

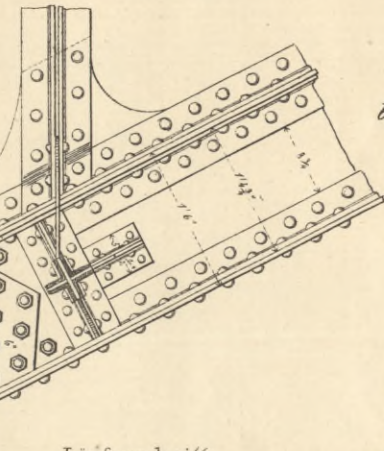

Grundriss

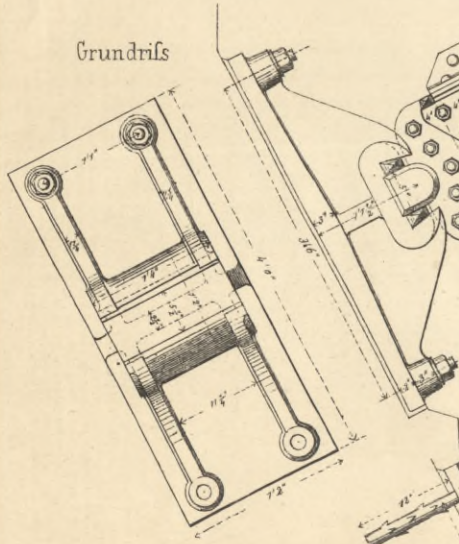

Längenschnitt.

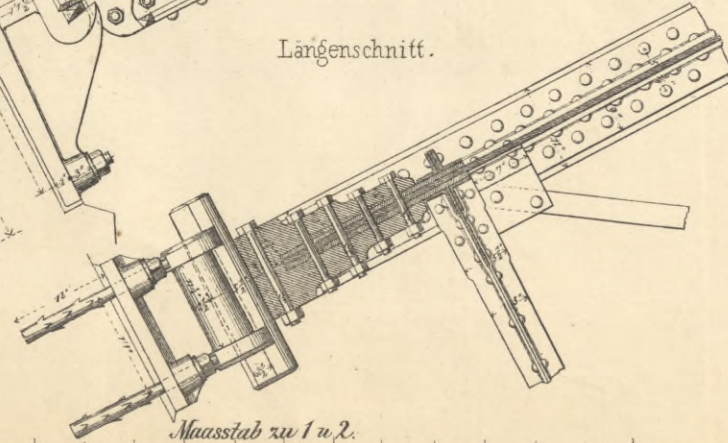

Maasstab zu 1 u. 2.

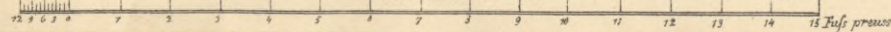

3. Ansicht eines Bogenstücks

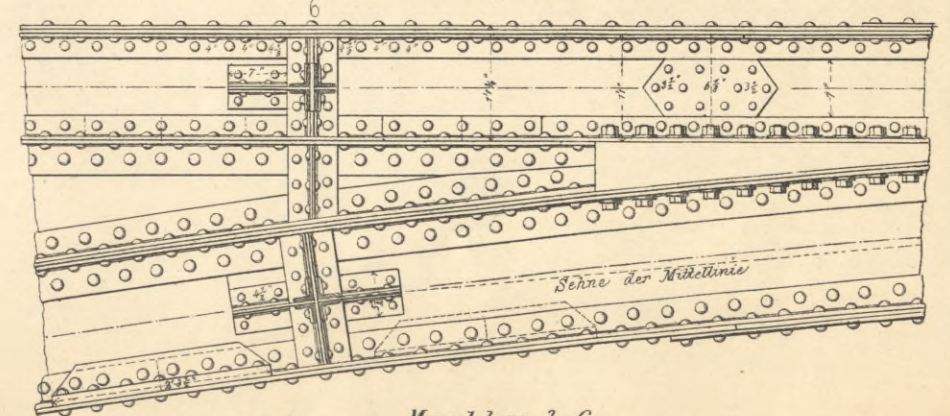

Maasstab zu 3-6.

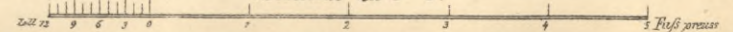

Bogenbrücke bei London von Fox u. Henderson.

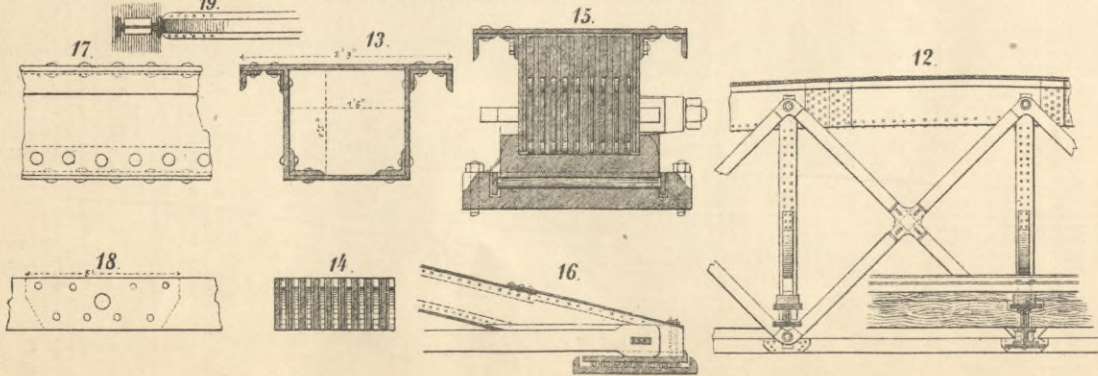
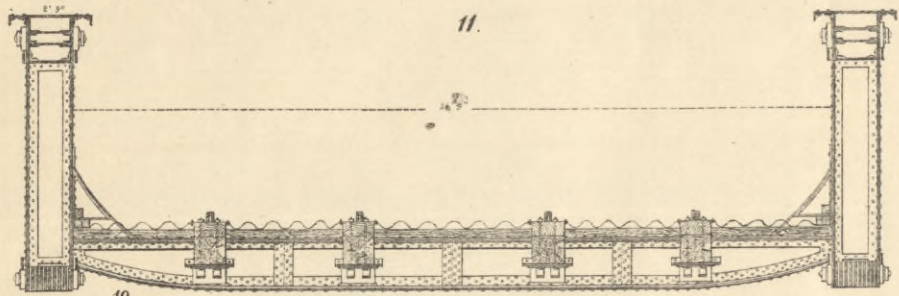
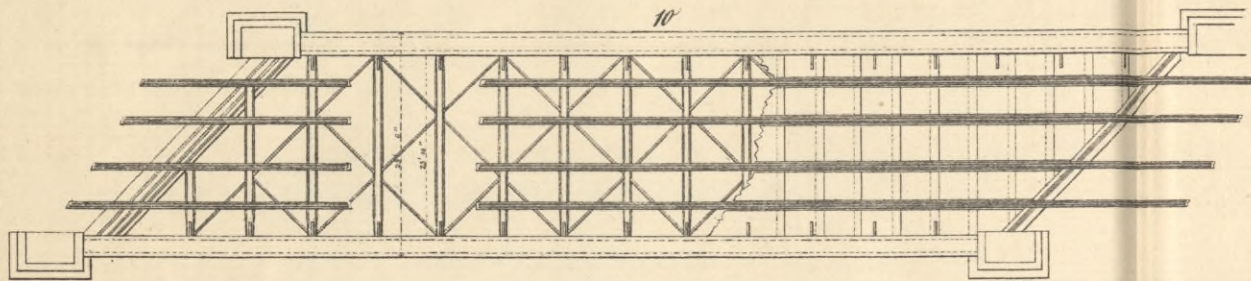
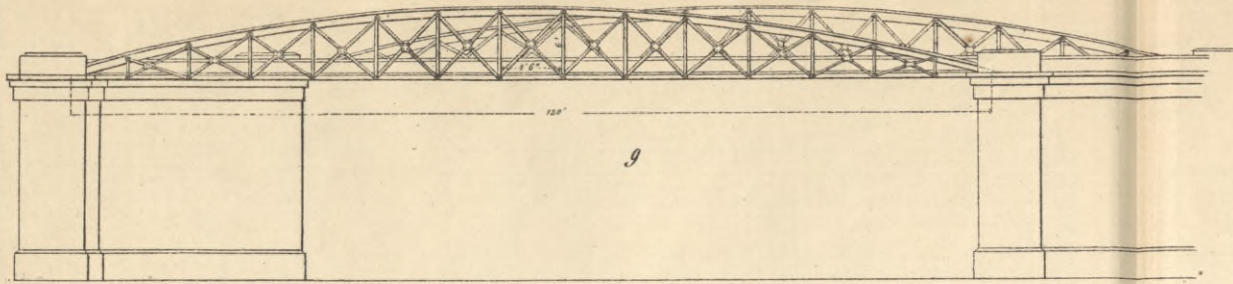

40 engl. Fuss zu 9 u. 10.
40 engl. Fuss zu 11, 12, 16.

Rieder's eiserne Fachwerk Brücke

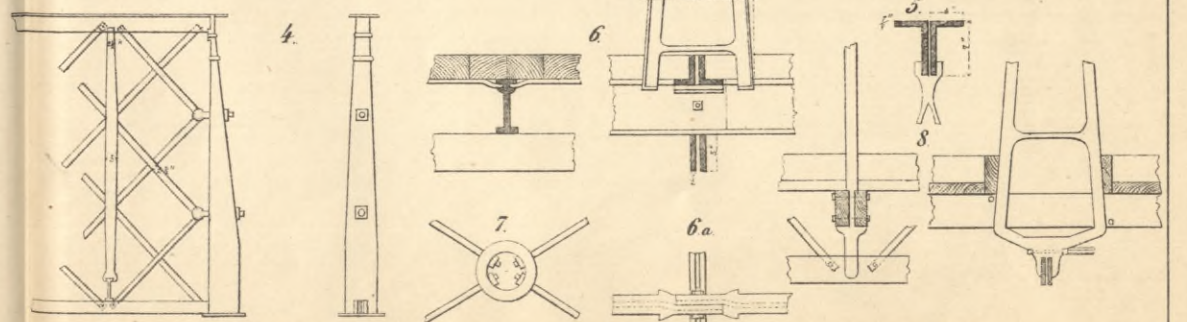
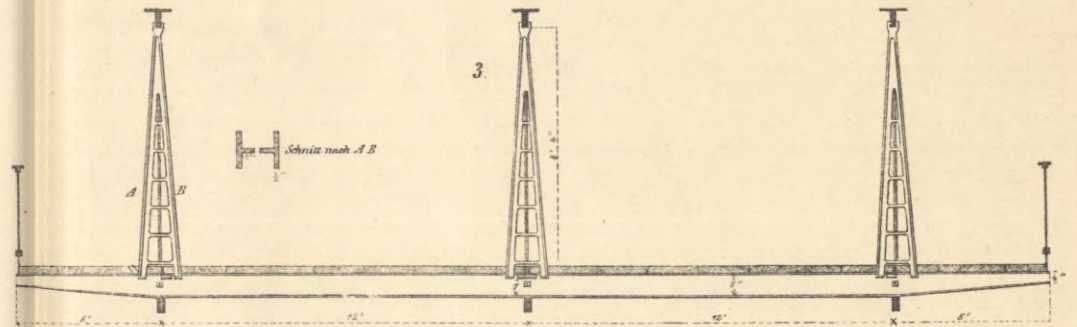
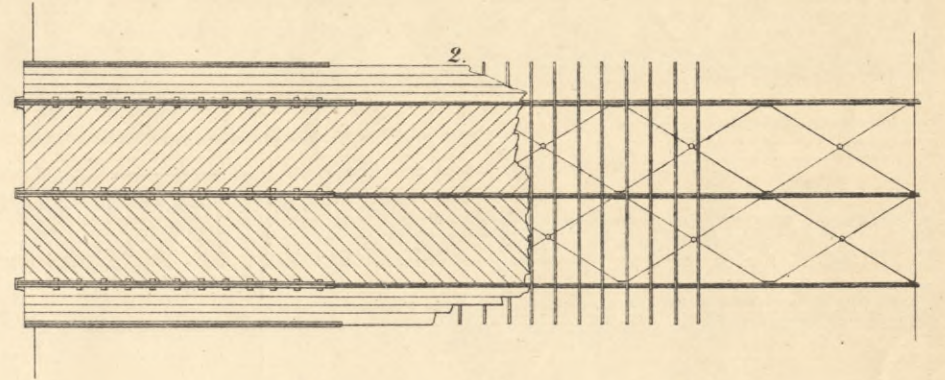
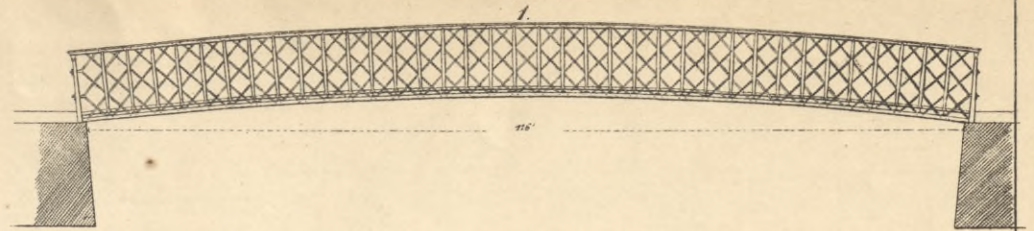

zu 1 u. 2
40 engl. Fuss
zu 3 u. 4
40 engl. Fuss

Theorie der Fachwerkbrücken

von J. G. Schwedler

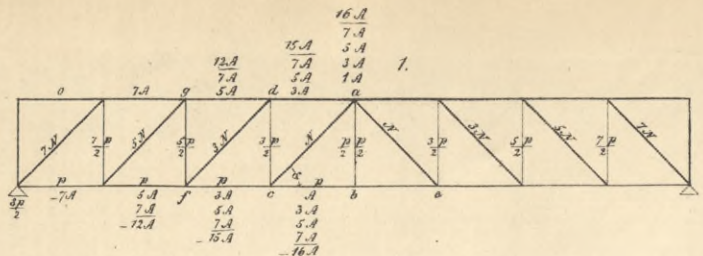

1.

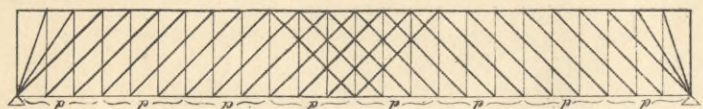

2.

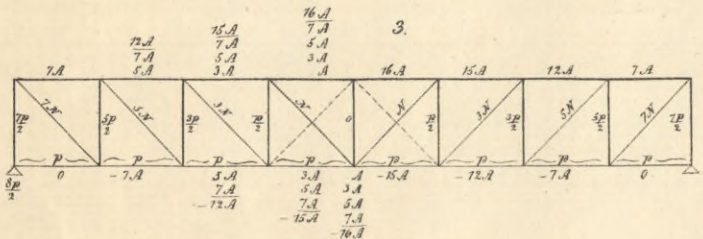

3.

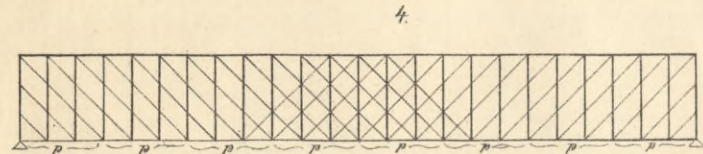

4.

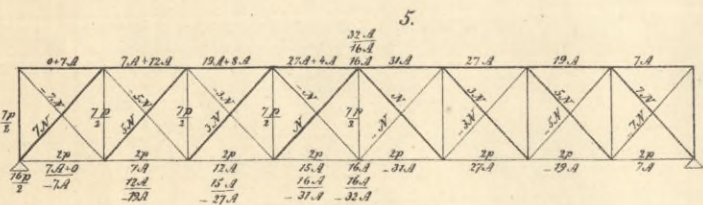

5.

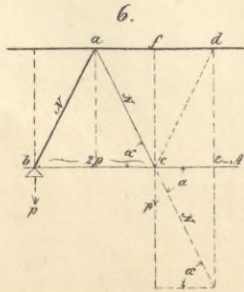
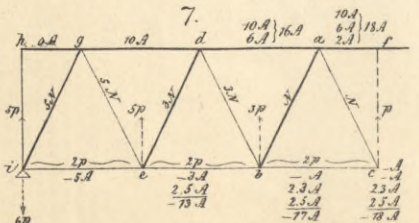

6.

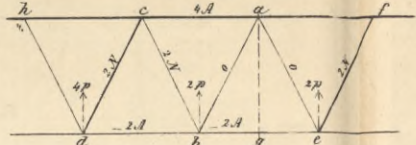

8.

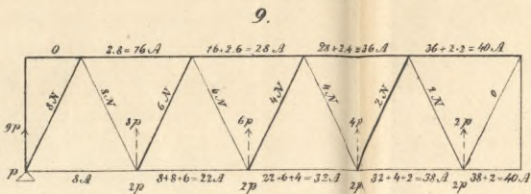

9.

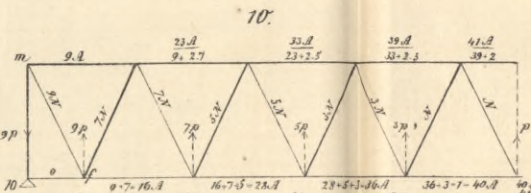

10.

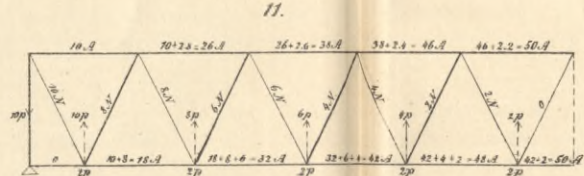

11.

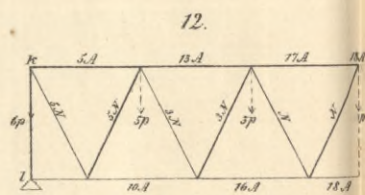

12.

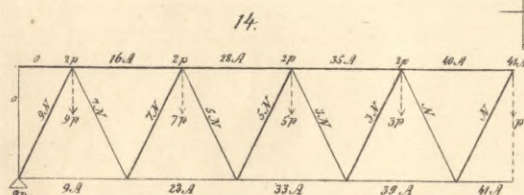

13.

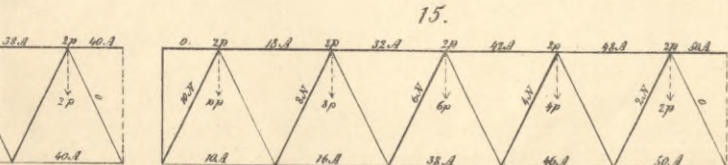

14.

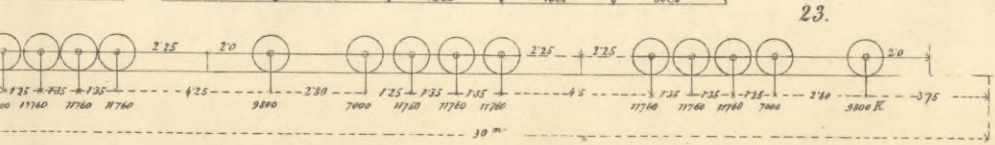

15.

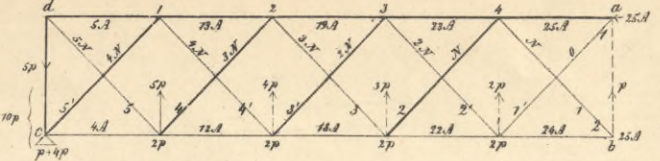

16.

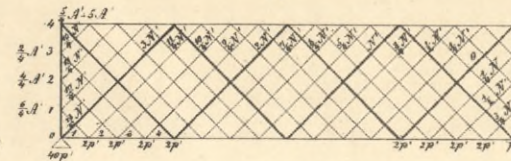

17.

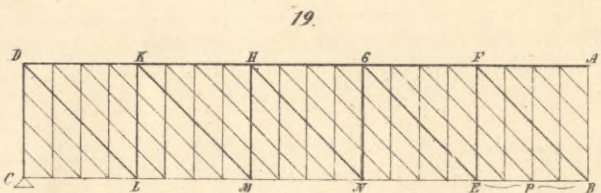

18.

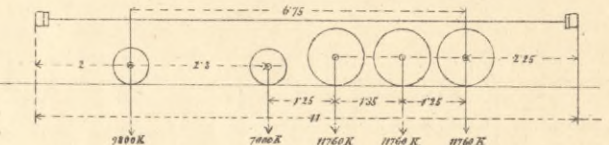

19.

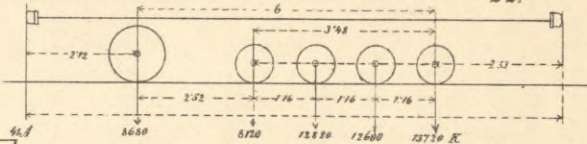

20.



21.

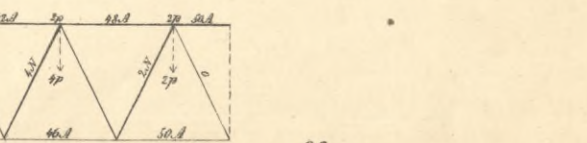

22.

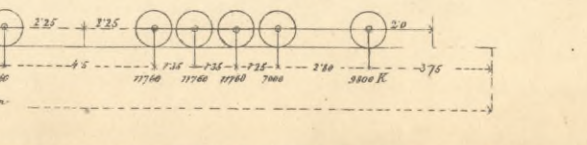

23.

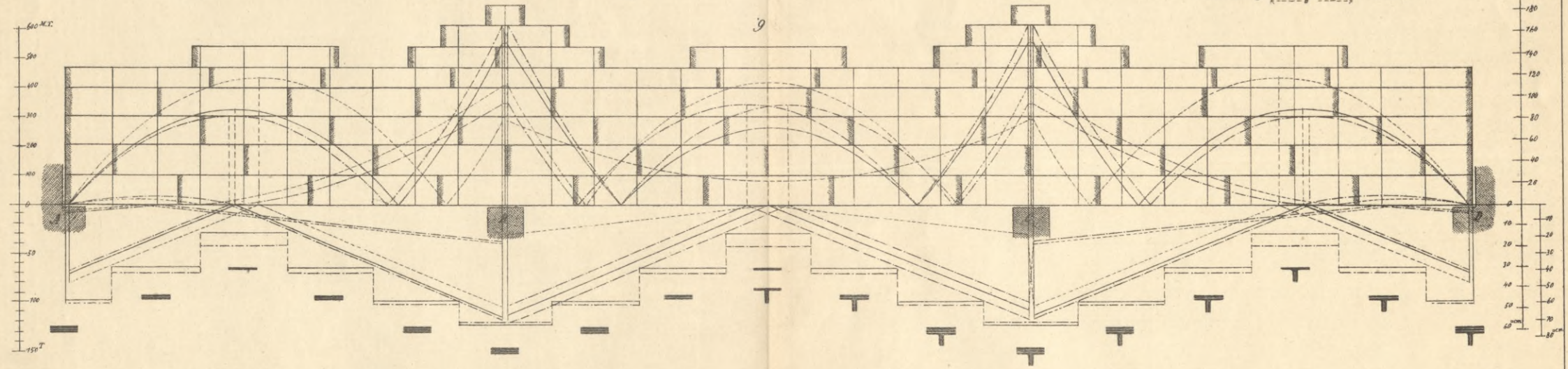
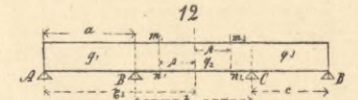
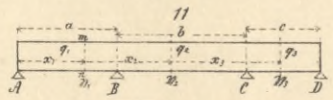
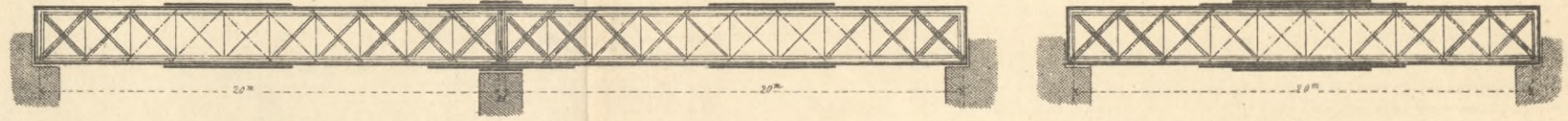
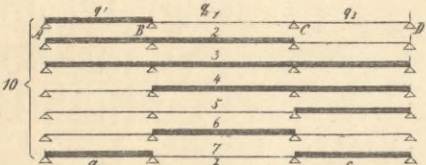
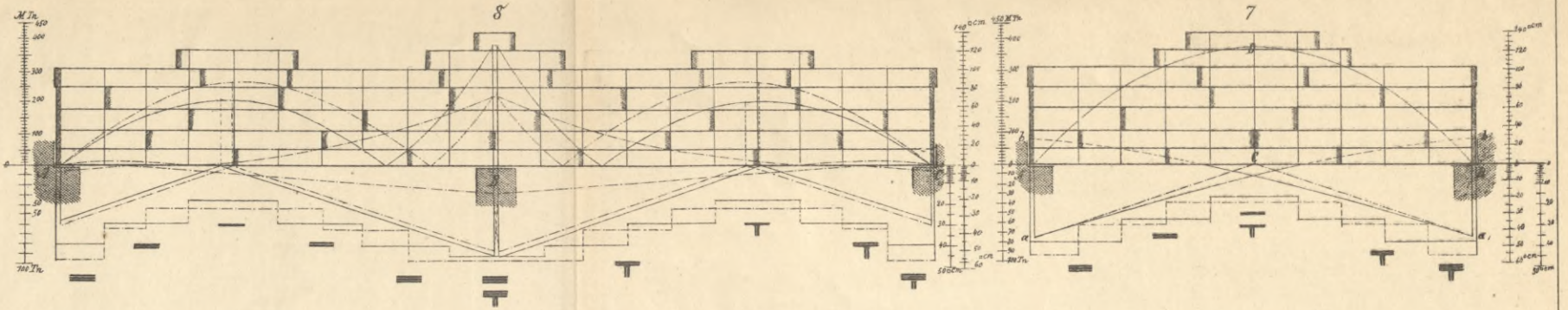
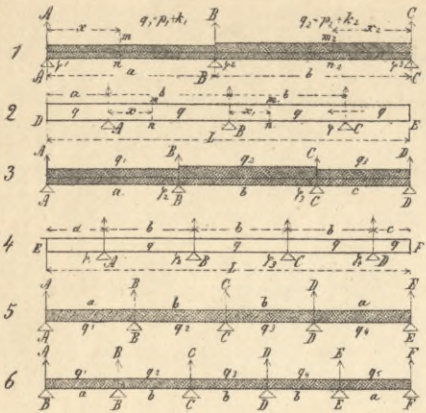

1: 200 d. v. Gr.

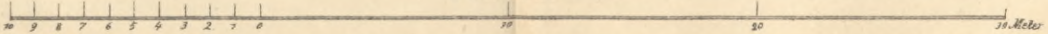

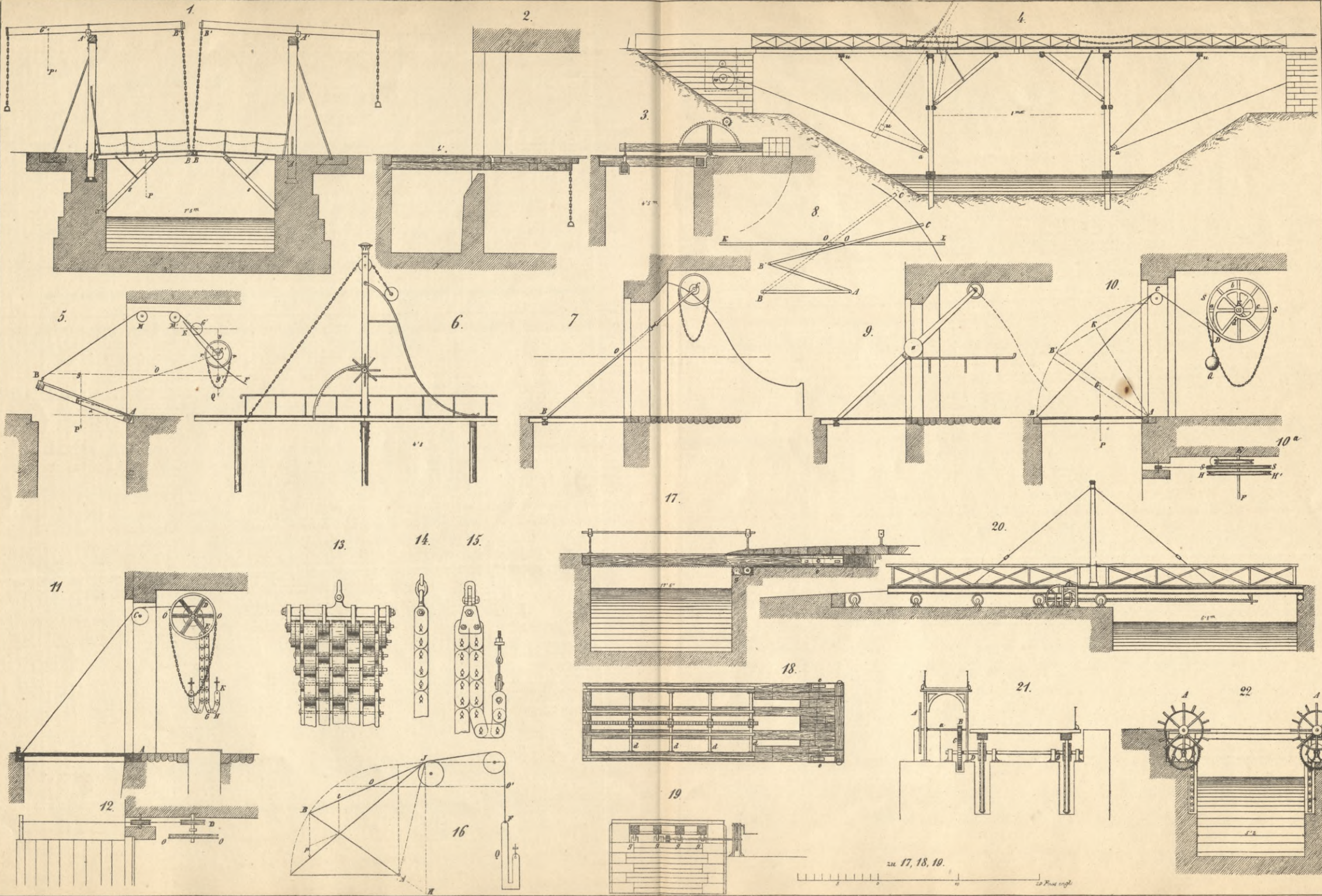

zu 17, 18, 19. 20 Fuss engl.

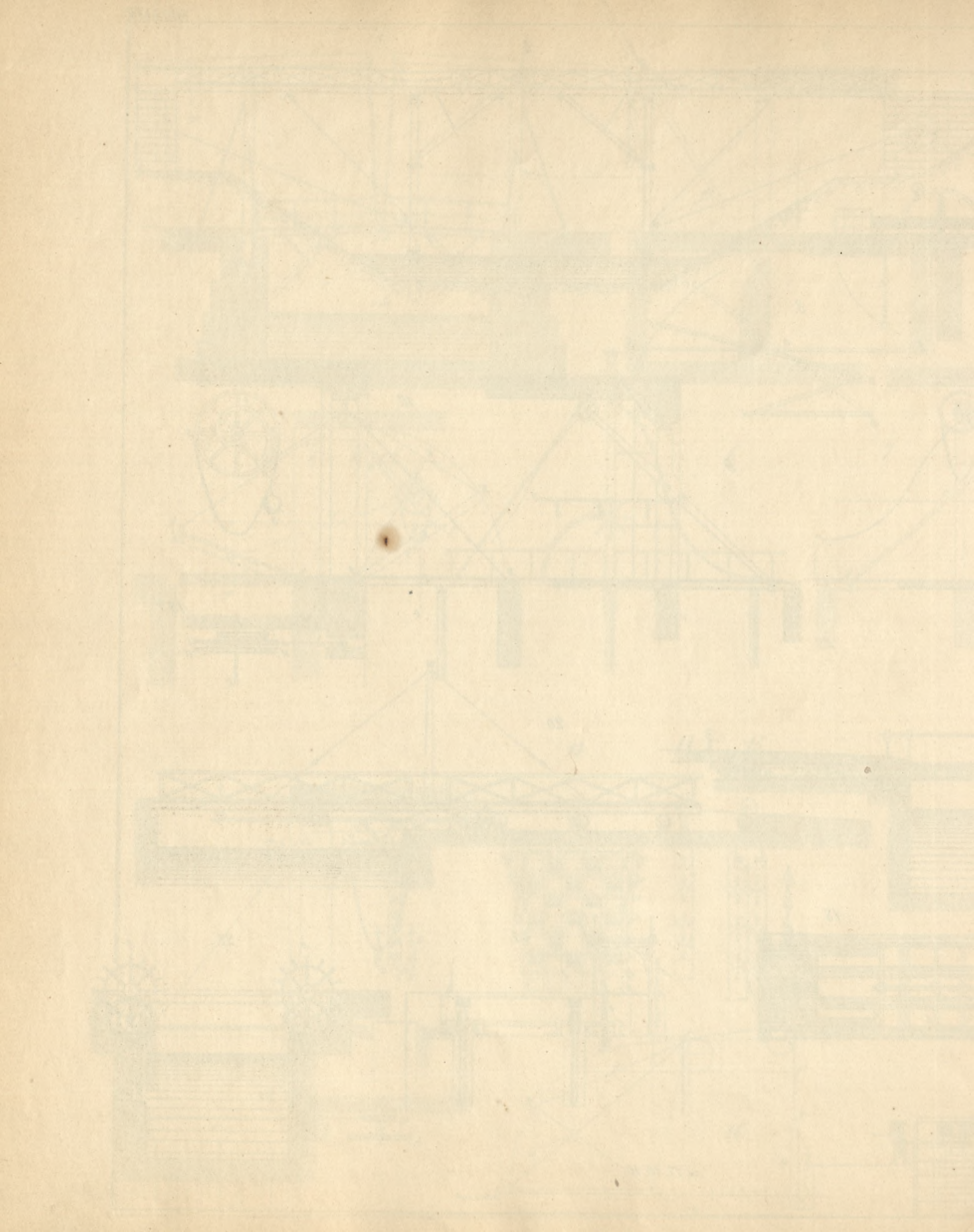

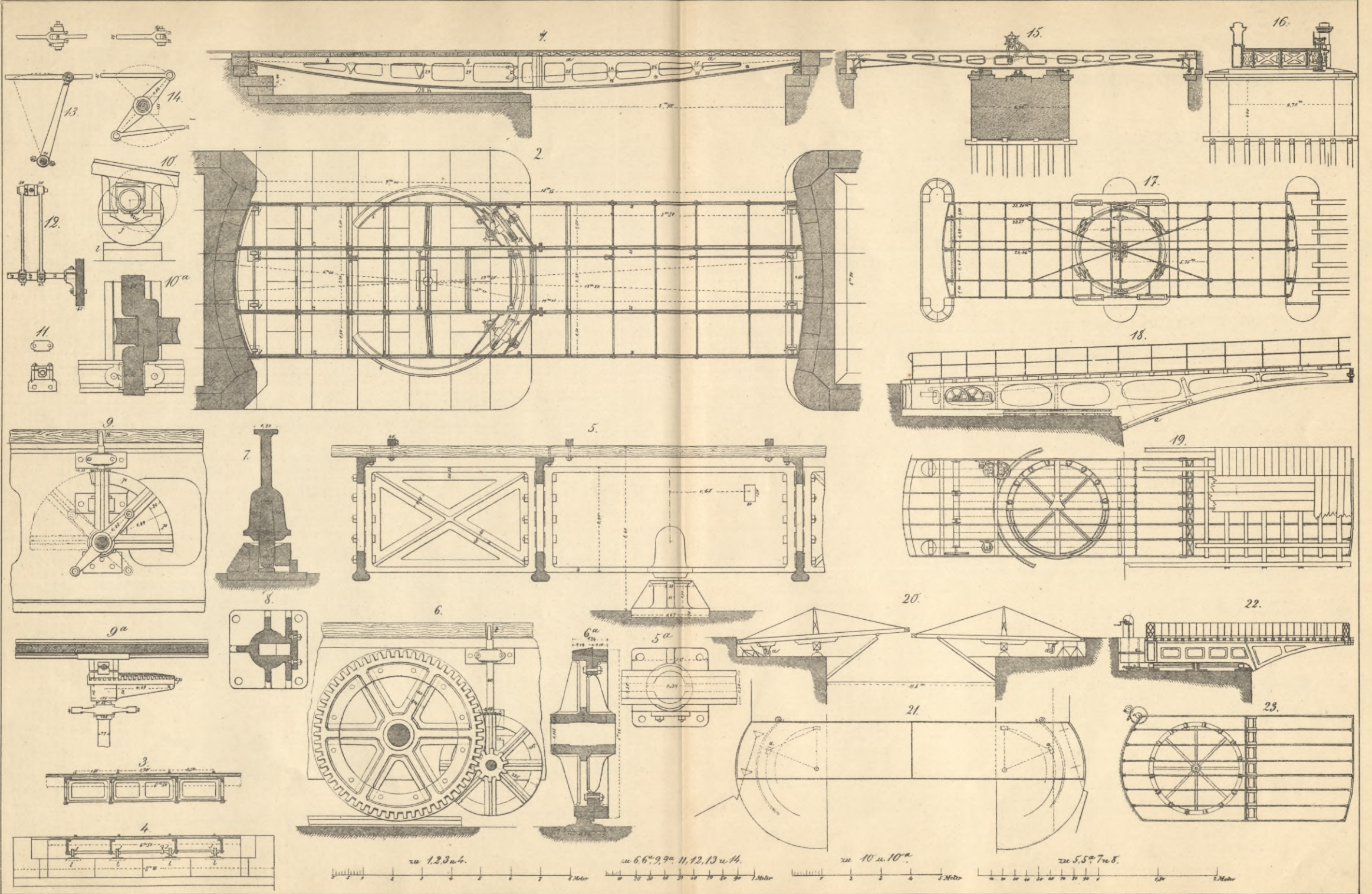

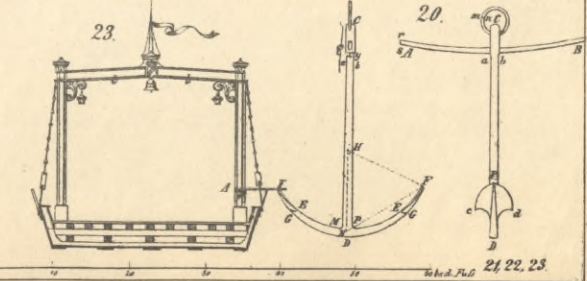
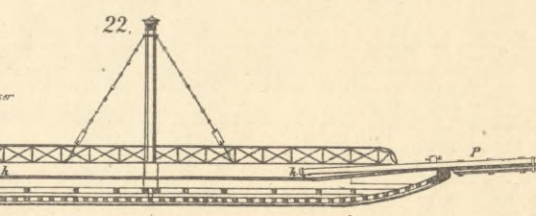
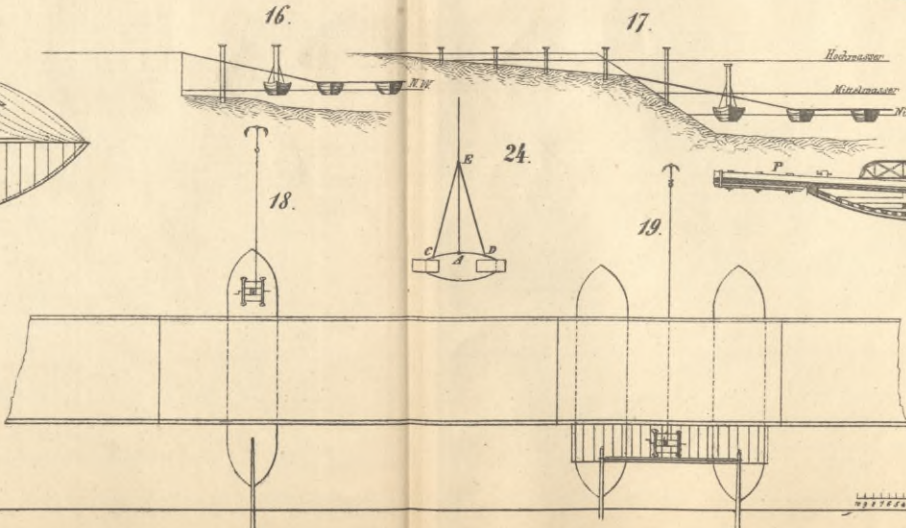
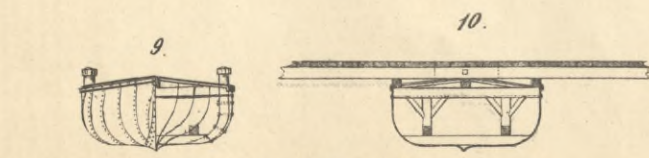
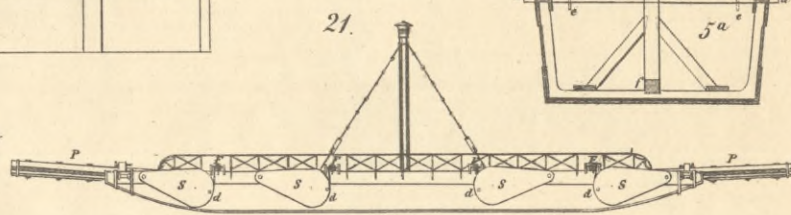
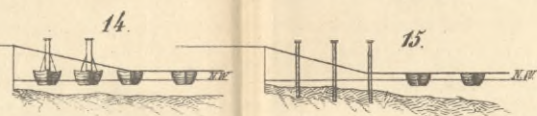
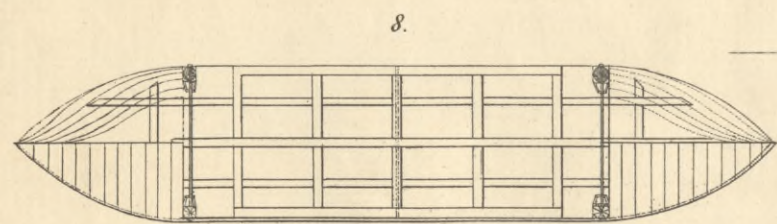
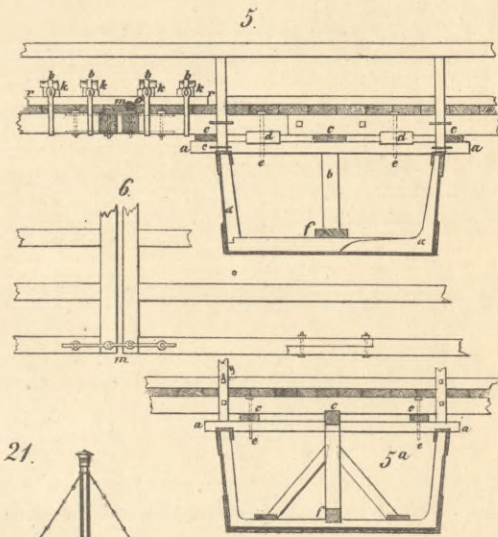
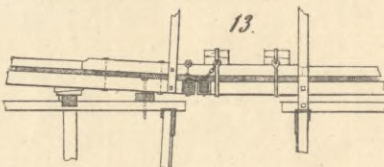
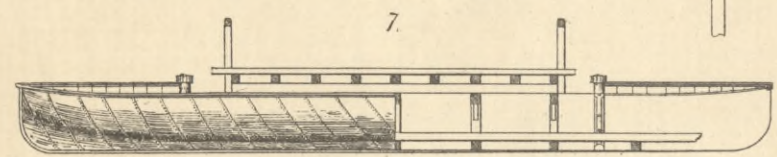
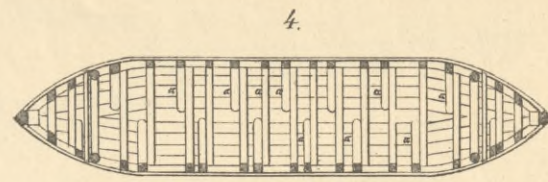
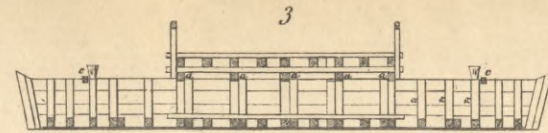
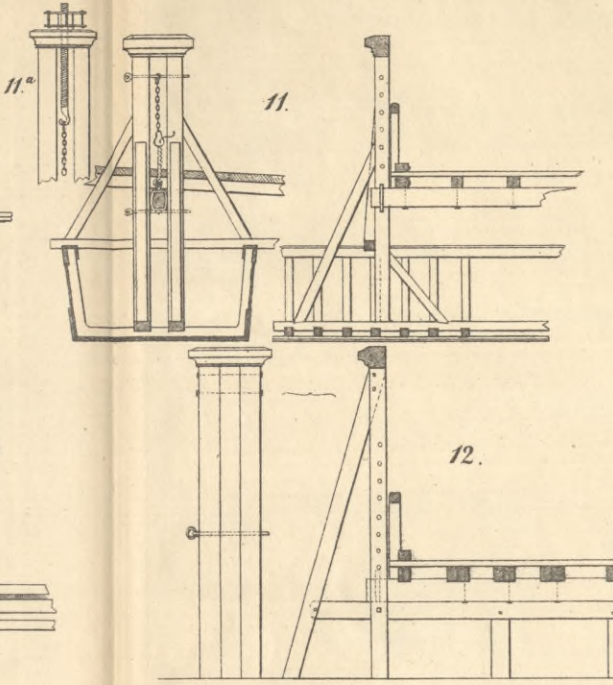
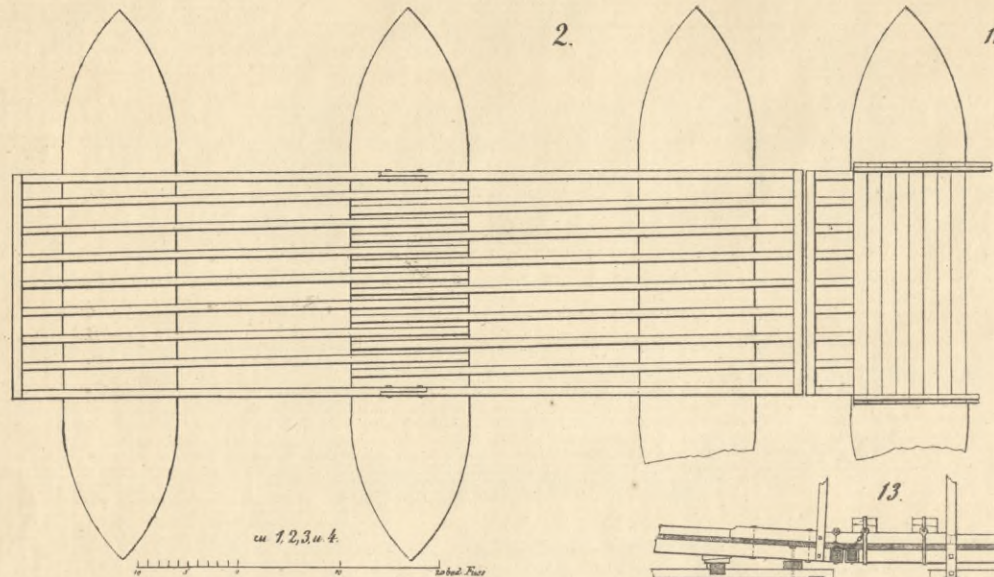
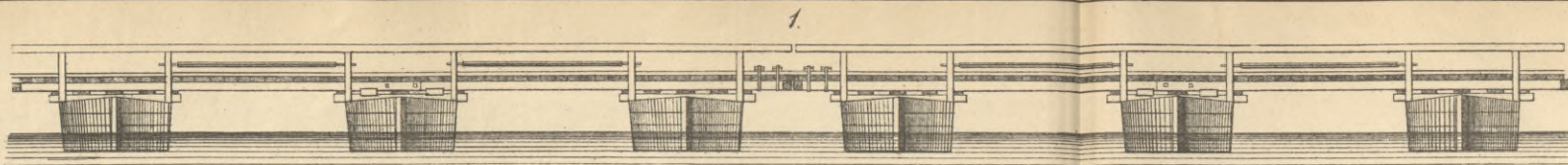

10 holl. Fu. zu 7, 8, 9, 10. 30 holl. Fu. zu 5, 5a, 6, 11 u. 12.

30 holl. Fu. zu 21, 22, 25.

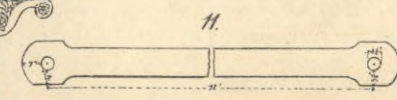
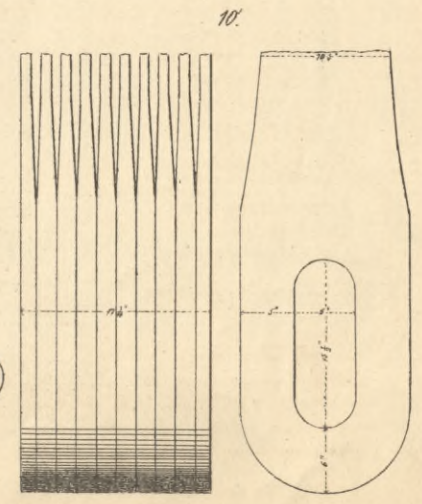
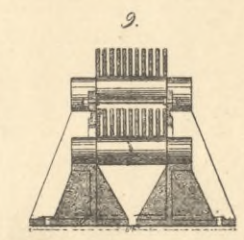
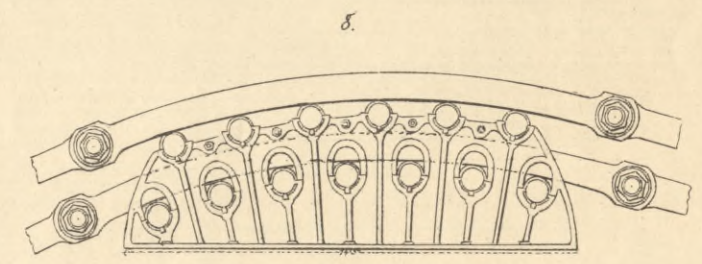
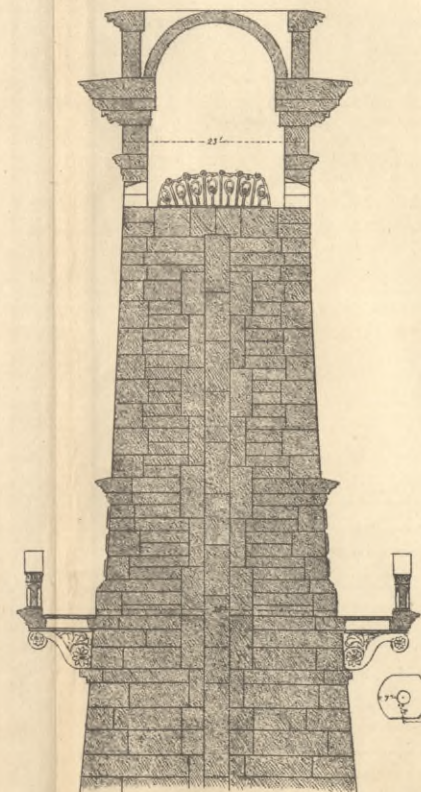
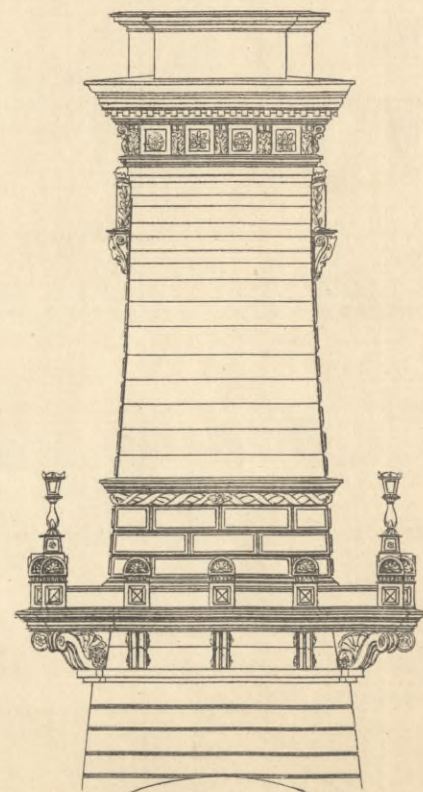
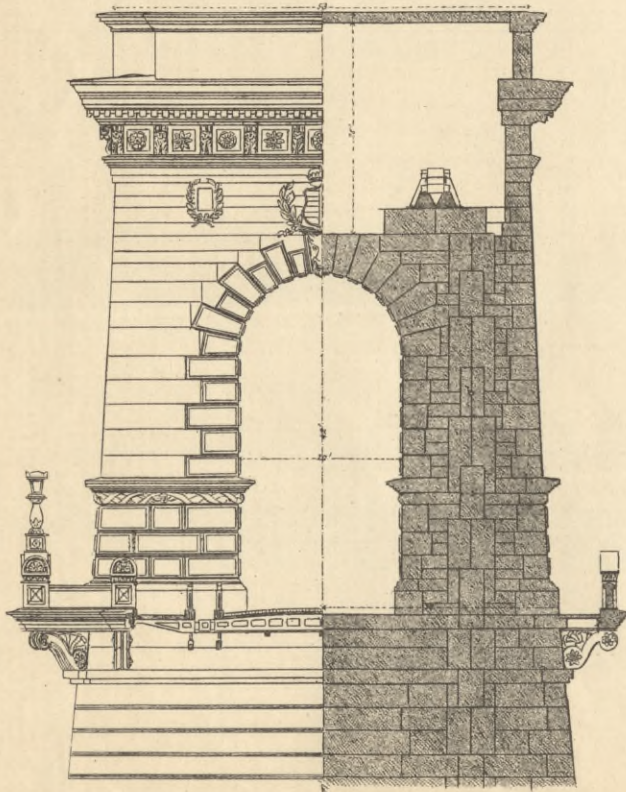
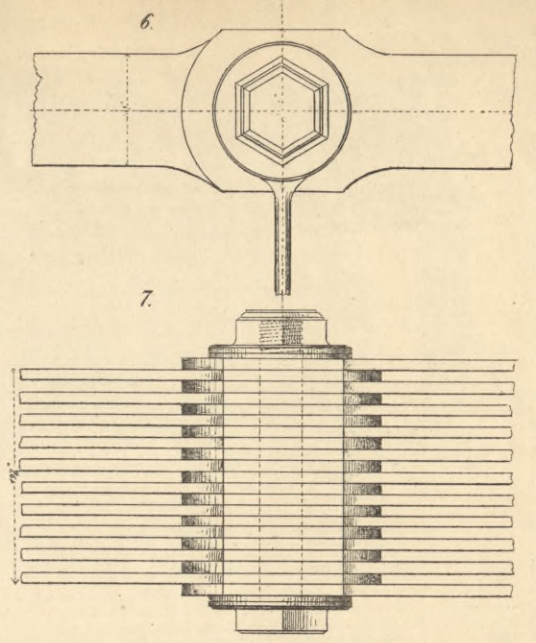
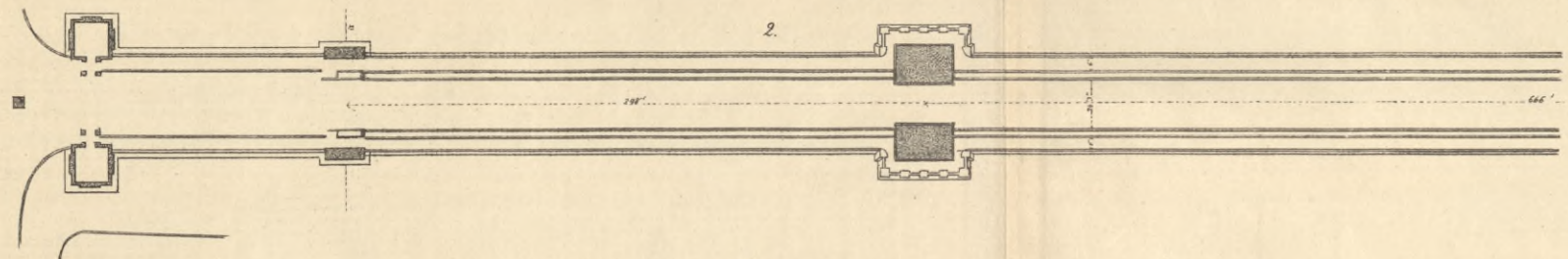
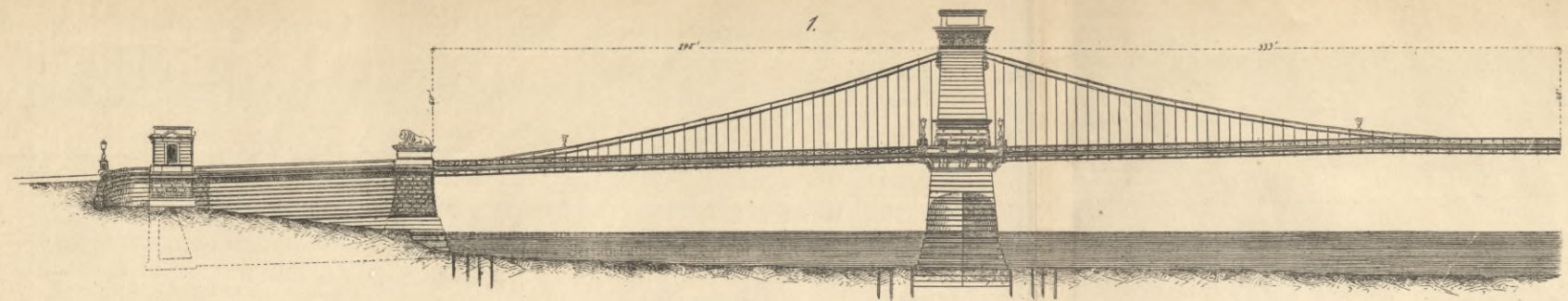

zu 1 u 2.
0 10 20 30 40 50 60 70 80 90 100 110 120 130 140 150 160 170 180 190 200 Maß engl.

zu 3, 4 u 5.
0 10 20 30 40 50 60 70 80 90 100 Maß engl.

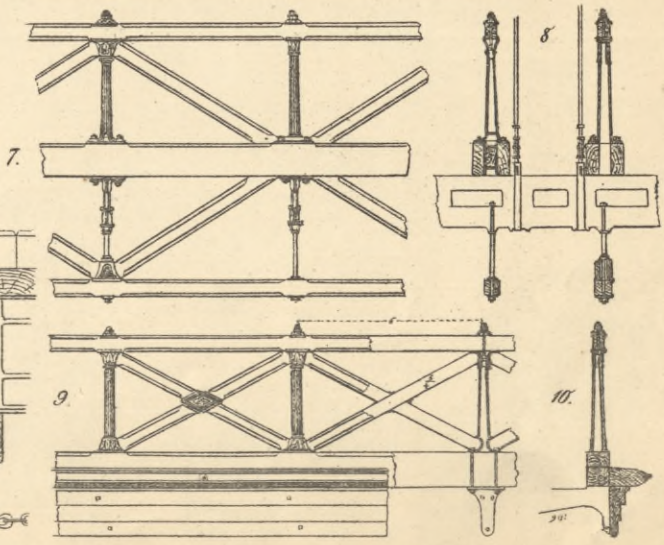
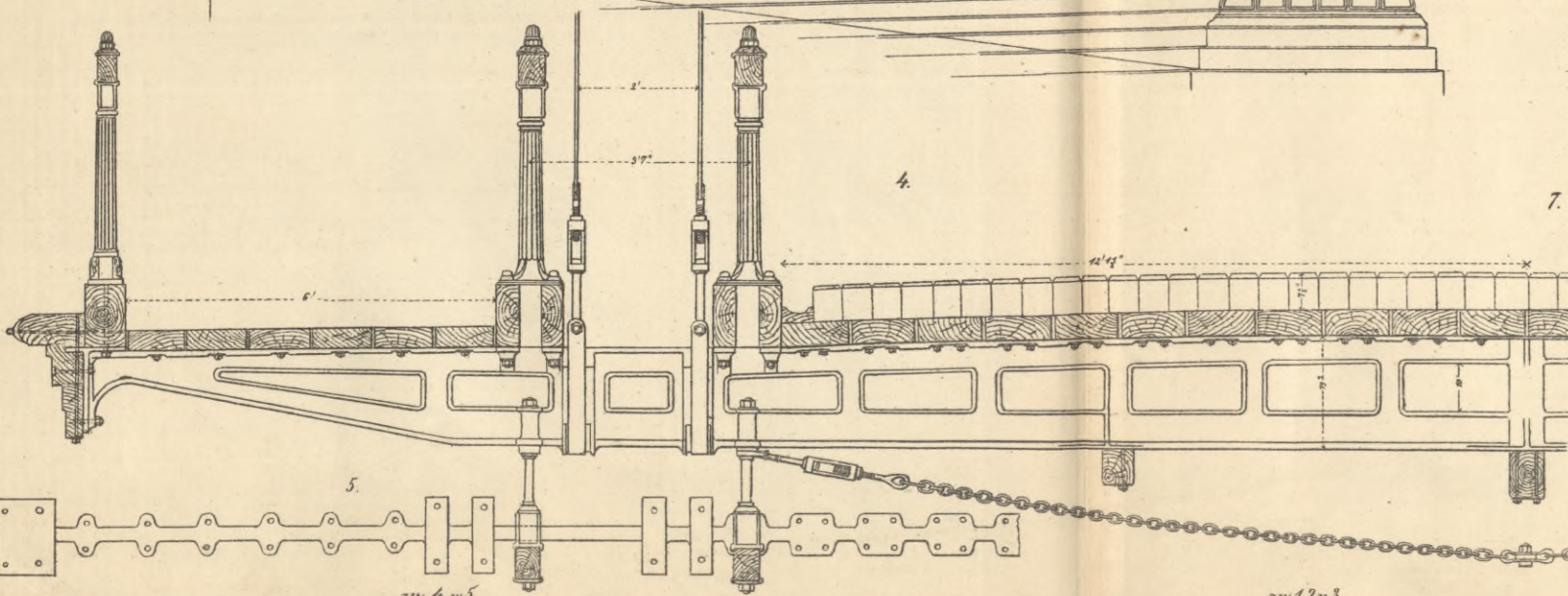
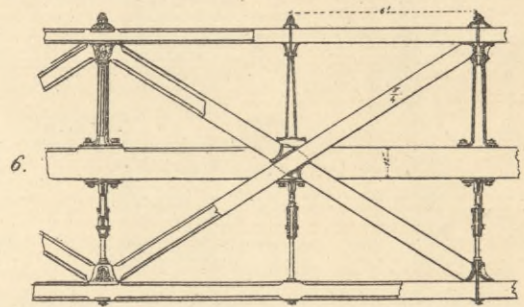
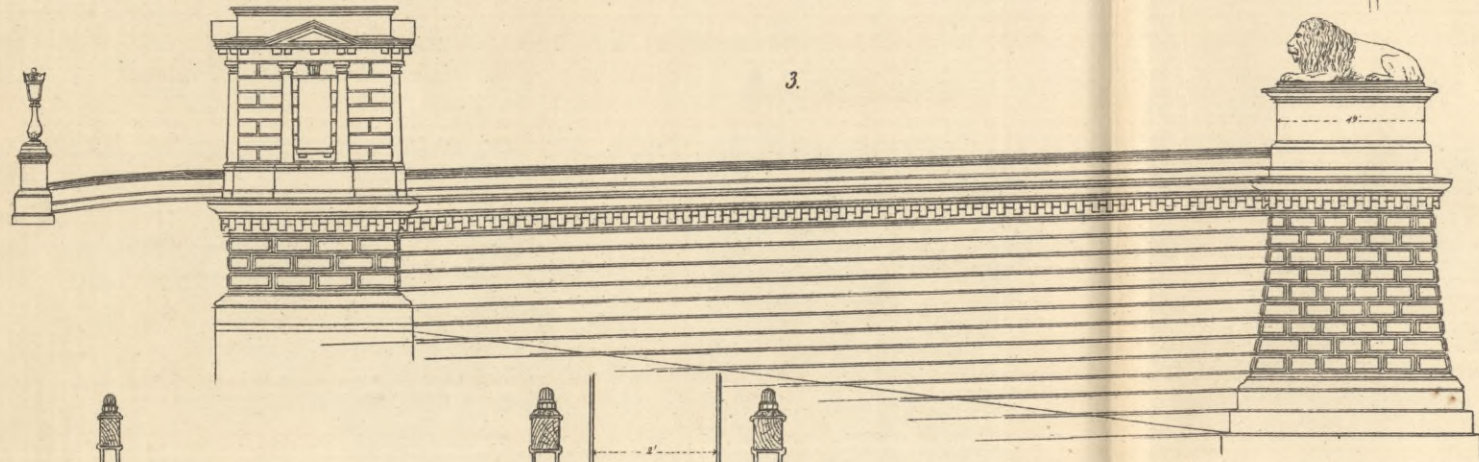
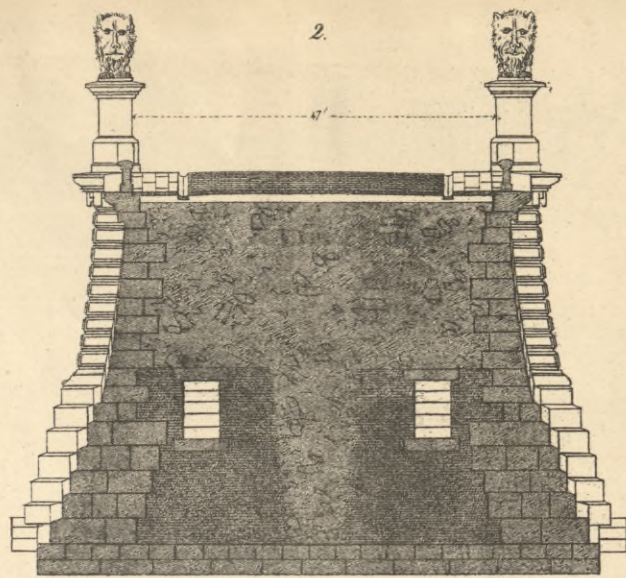
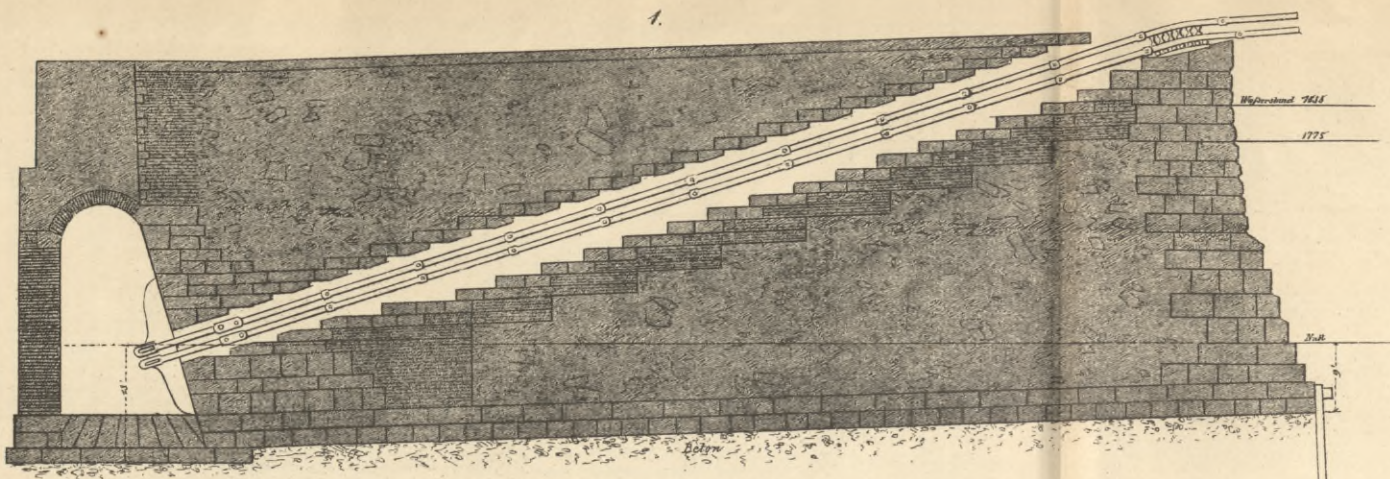

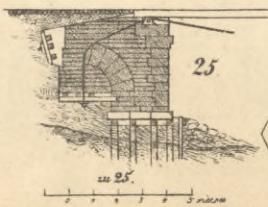
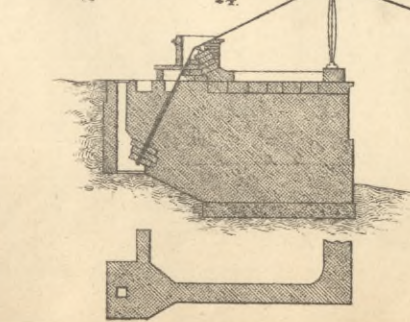
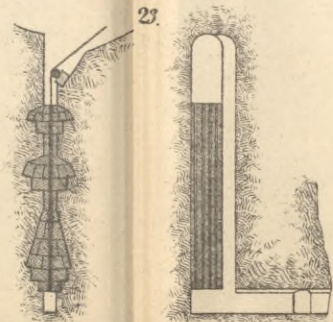
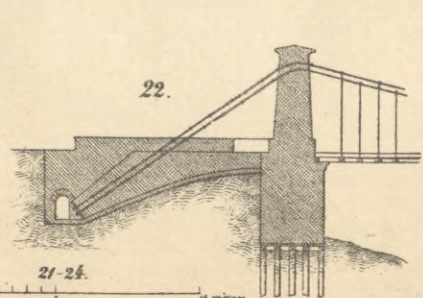
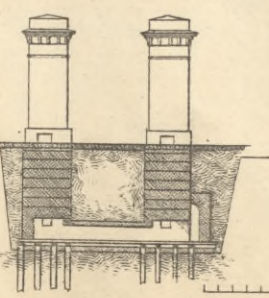
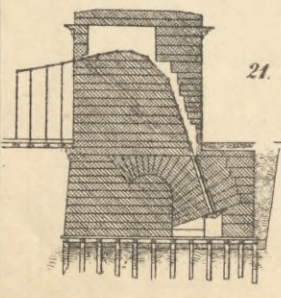
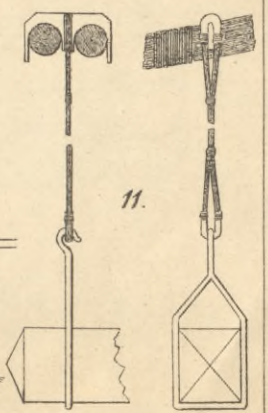
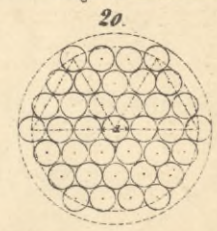
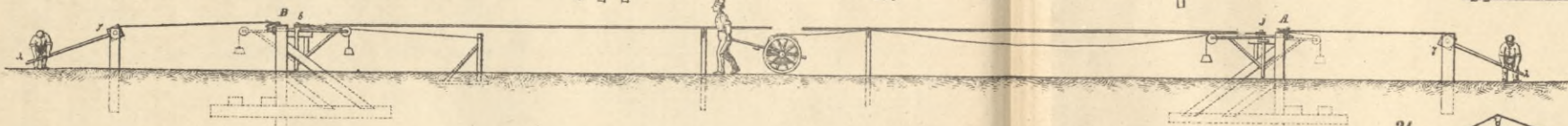
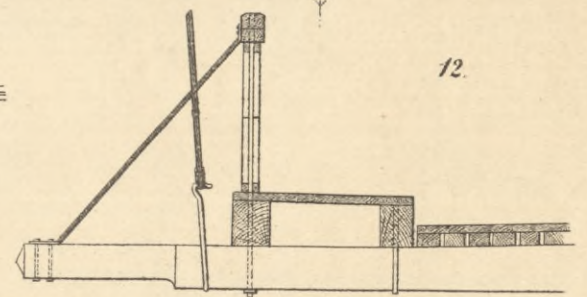
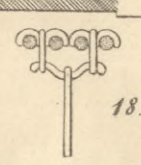
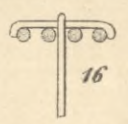
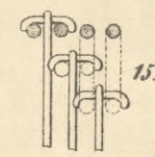
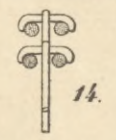
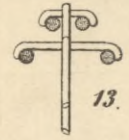
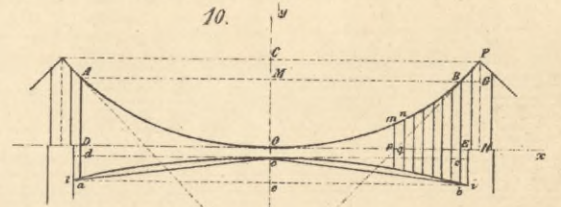
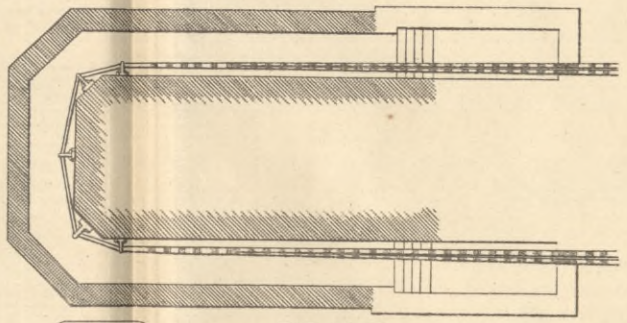
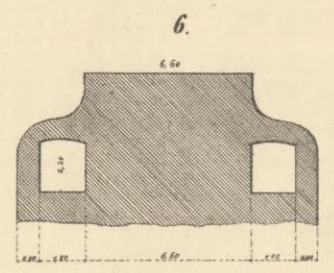
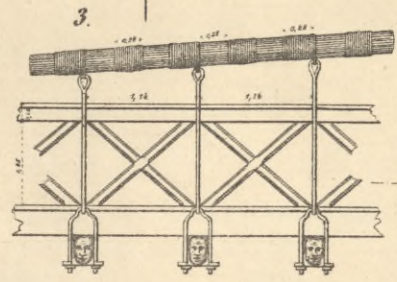
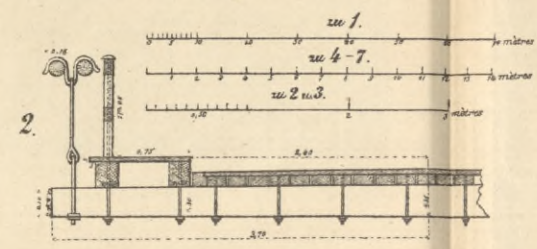
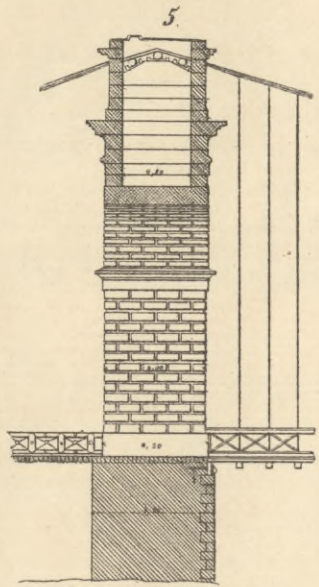
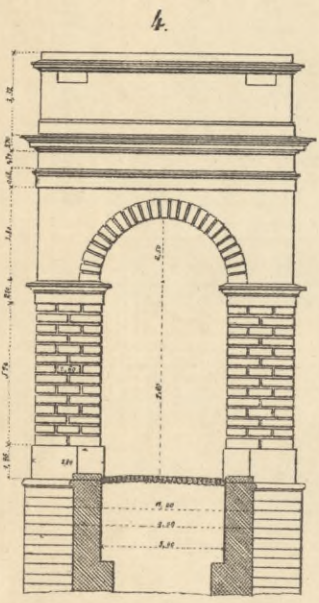
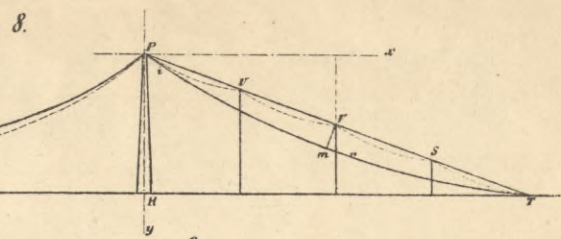
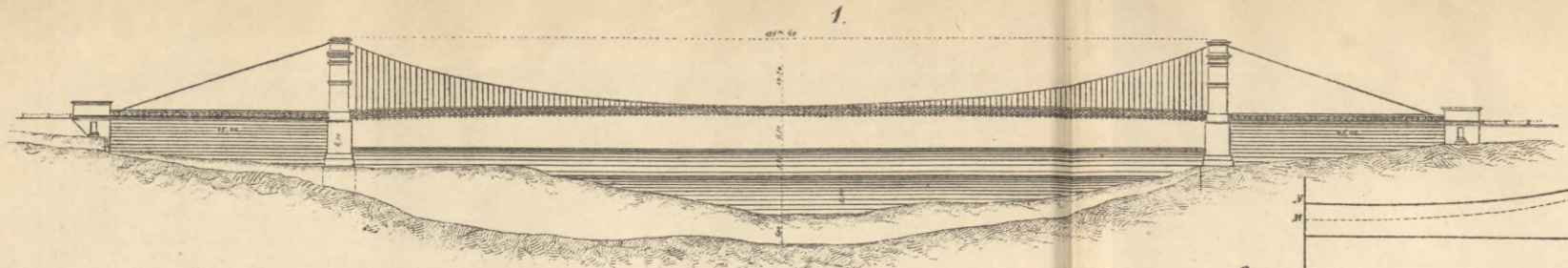

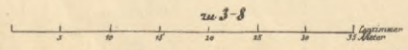
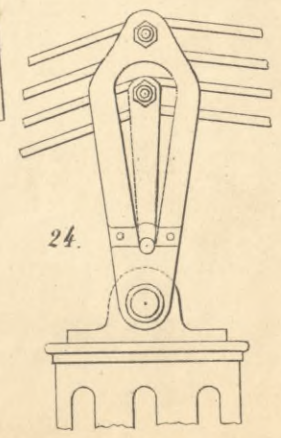
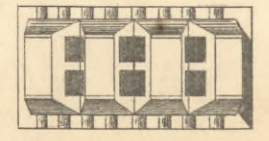
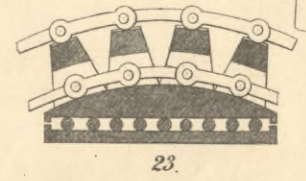
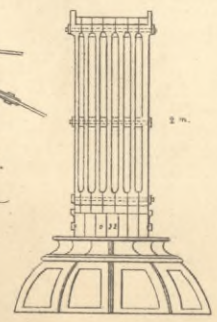
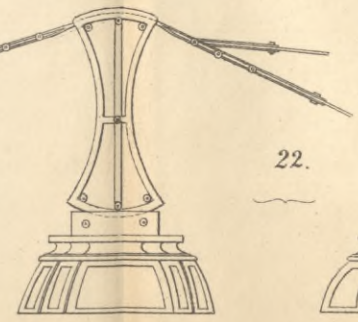
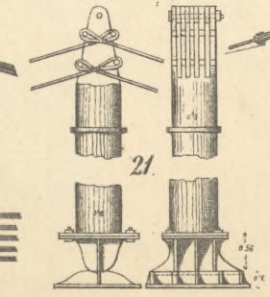
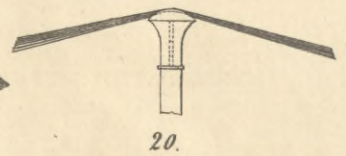
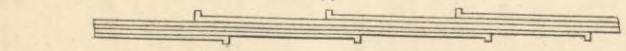
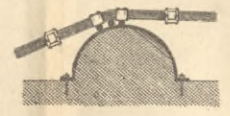
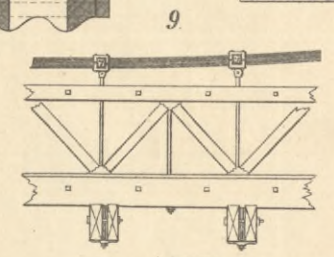
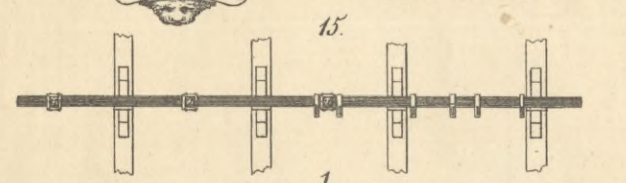
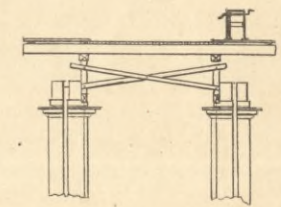
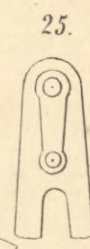
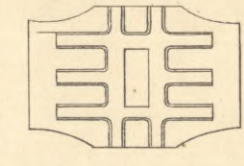
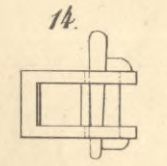
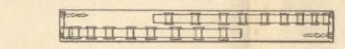
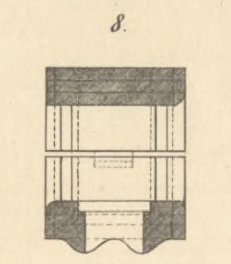
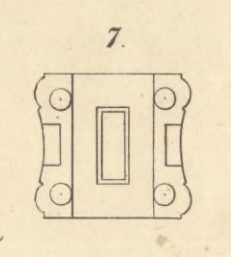
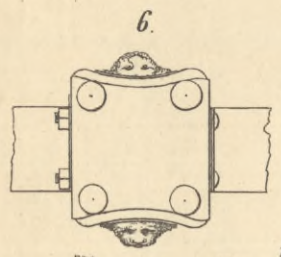
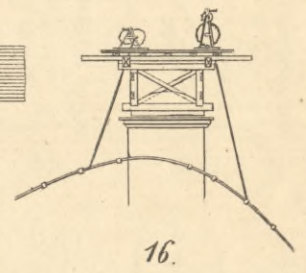
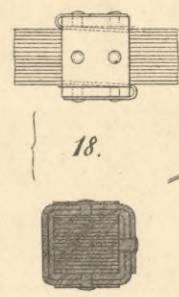
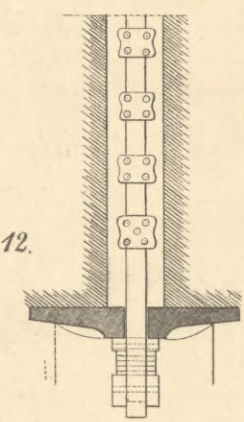
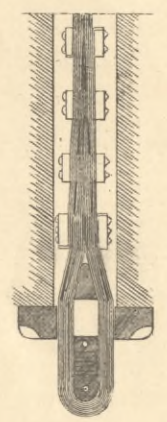
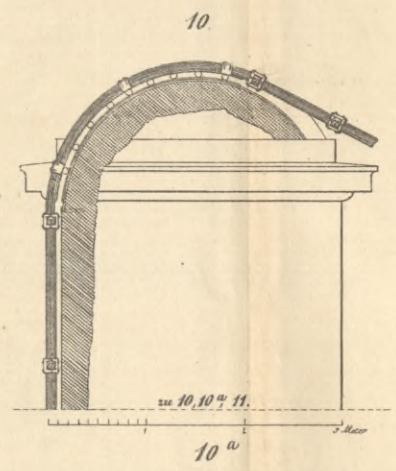
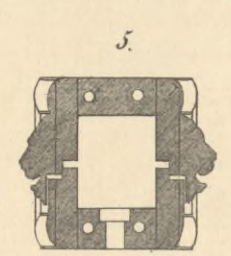
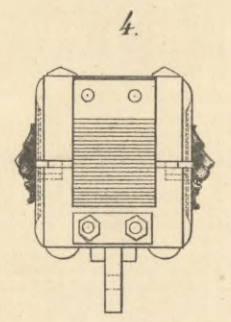
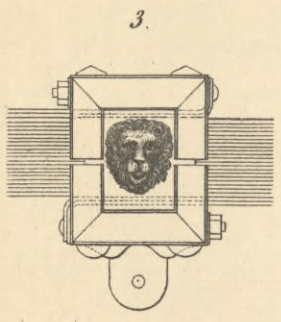
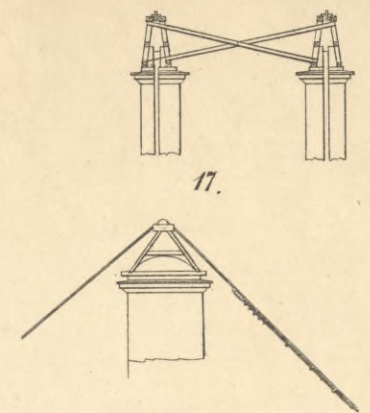
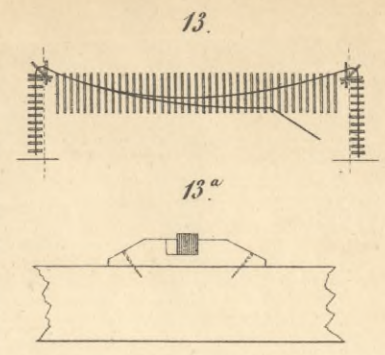
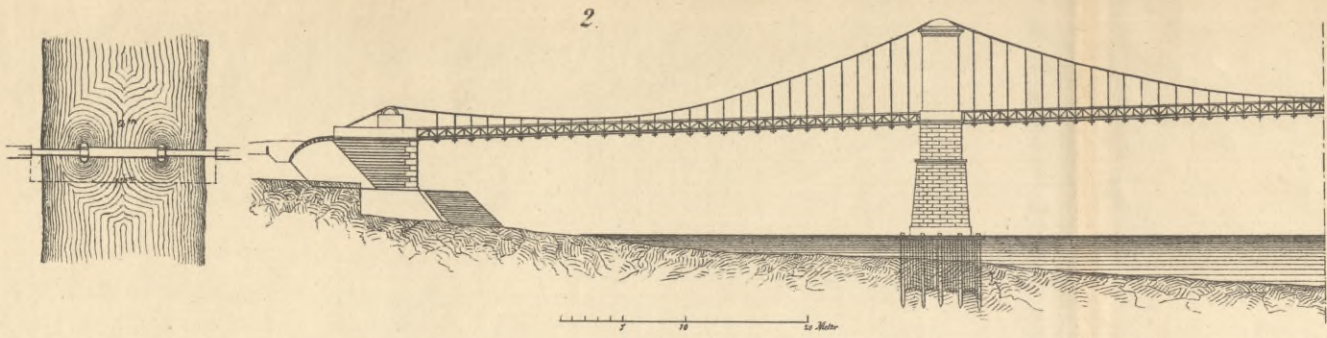

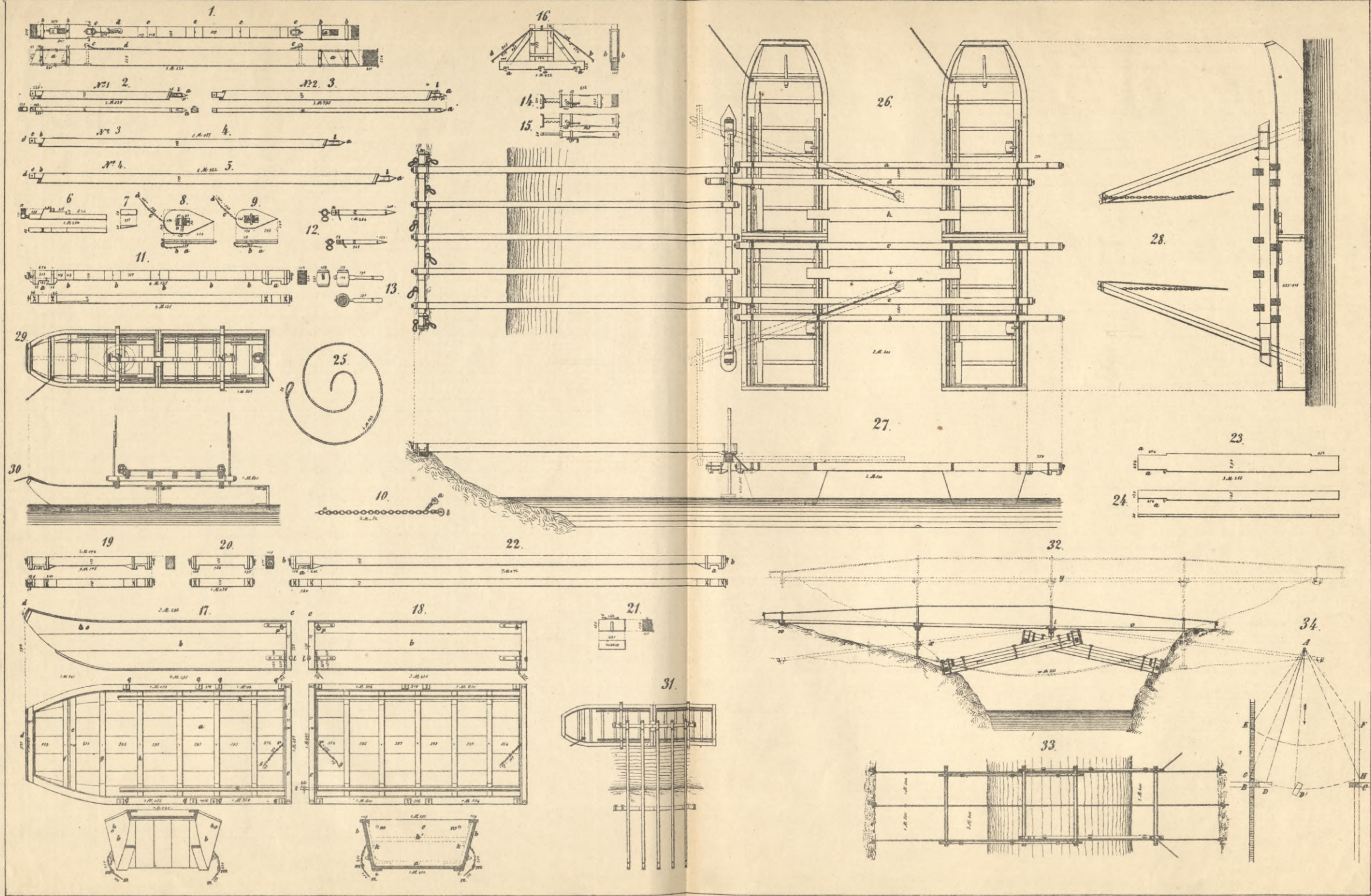

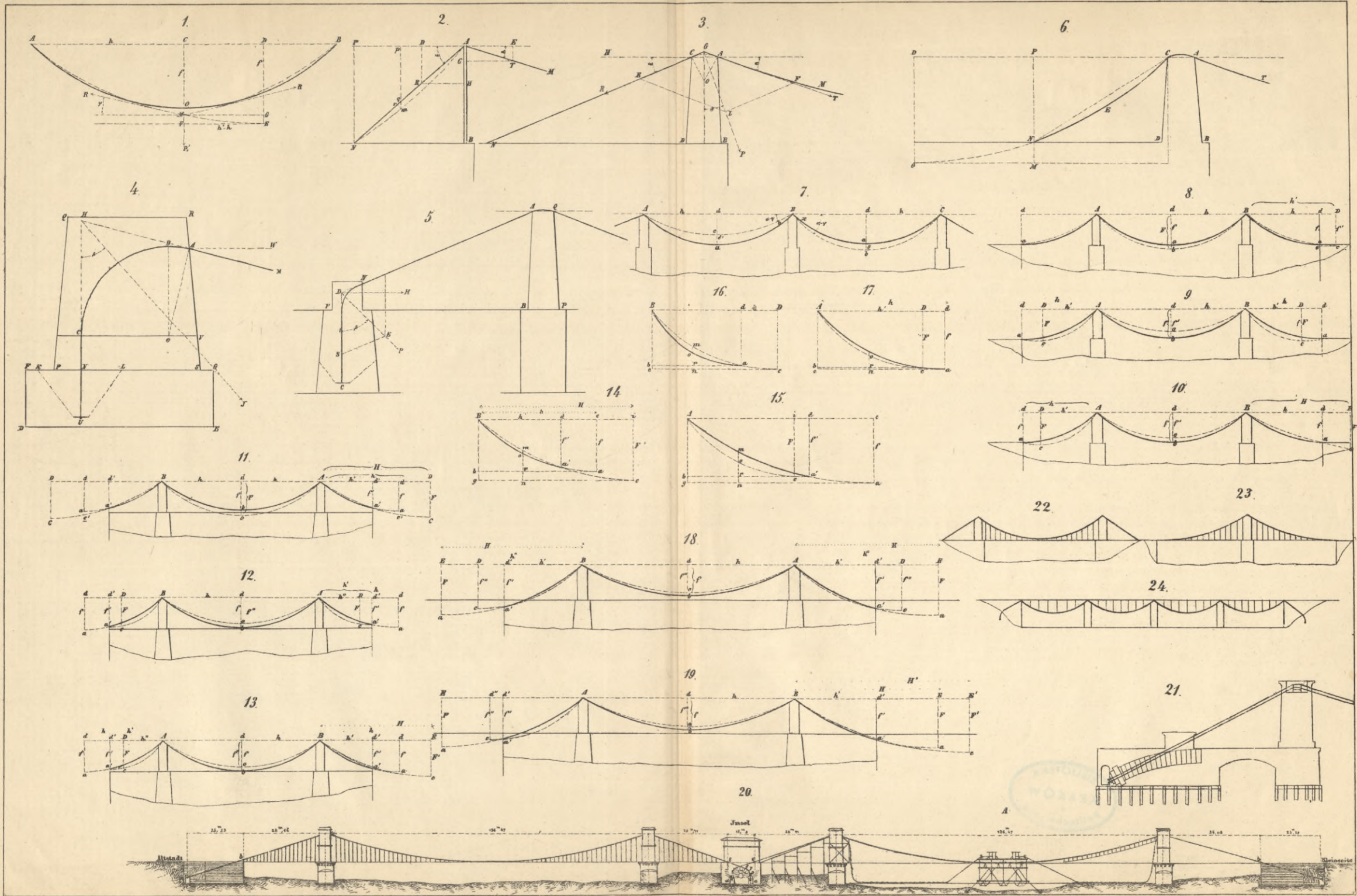

BIBLIOTEKA
KRAKÓW
*
Politechniczna

61

POLITECHNIKA KRAKOWSKA
BIBLIOTEKA GŁÓWNA

Biblioteka Politechniki Krakowskiej



IV-301197

Biblioteka Politechniki Krakowskiej



100000301157