



Biblioteka Politechniki Krakowskiej



10000300938

W.

PLATEN

BEHOORENDE BIJ DE

WATERBOUWKUNDE,

DOOR

N. H. HENKET, DR. Ch. M. SCHOLS EN J. M. TELDERS,

HOOGLEERAREN AAN DE POLYTECHNISCHE SCHOOL TE DELFT.

MET MEDEWERKING VAN

VERSCHILLENDE INGENIEURS.

DERDE DEEL (4^e gedeelte.)

Afd. XIV. Berekening der Bruggen.

F. Nr. 17433.



'S-GRAVENHAGE, DE GEBROEDERS VAN CLEEF.

17433



IV - 300960

~~III 18242~~

Akc. Nr. 1050/52

BPW-0277/2017



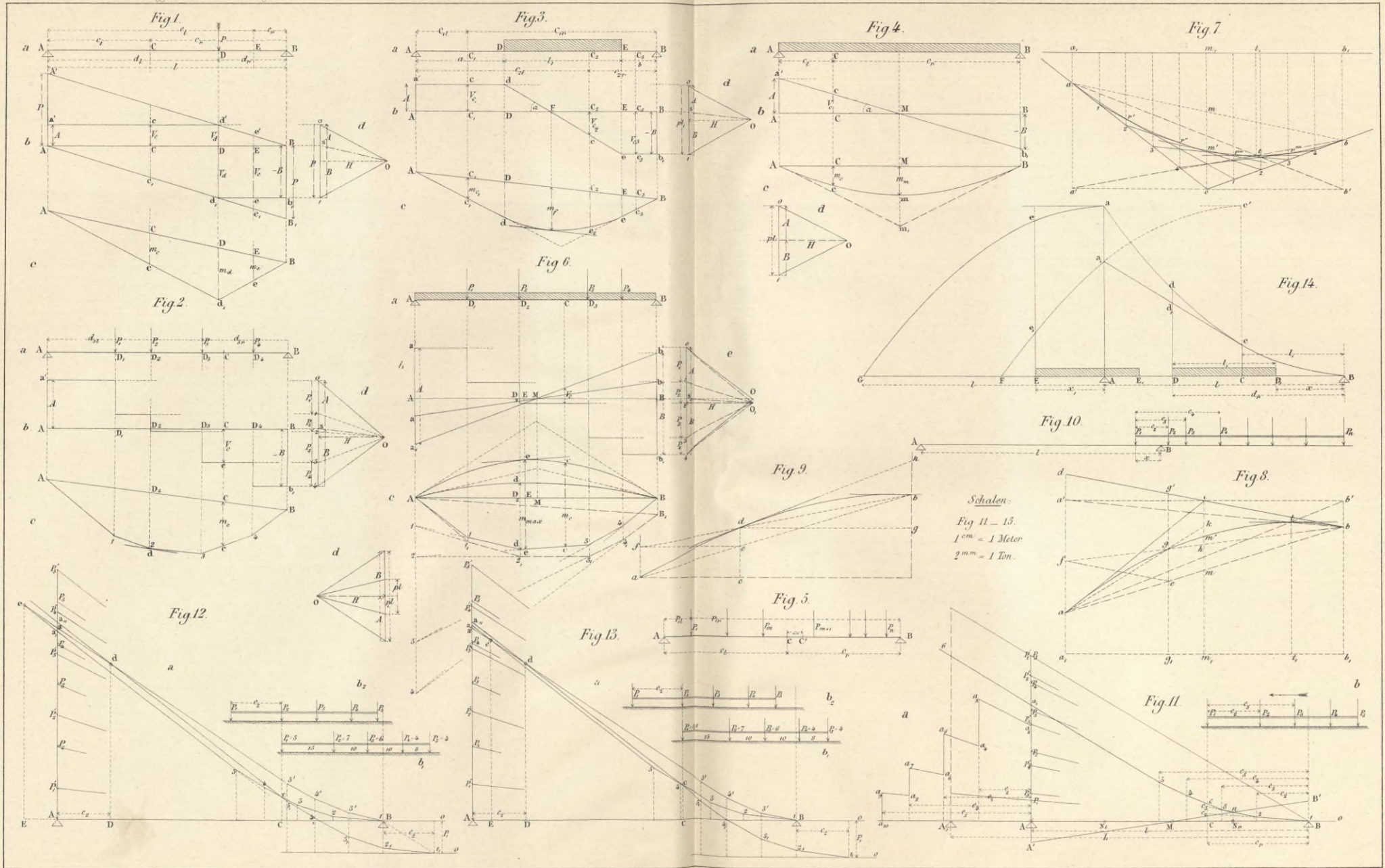

Schalen:
 Fig. 11 - 15.
 1 cm = 1 Meter
 2 m.m = 1 Ton.

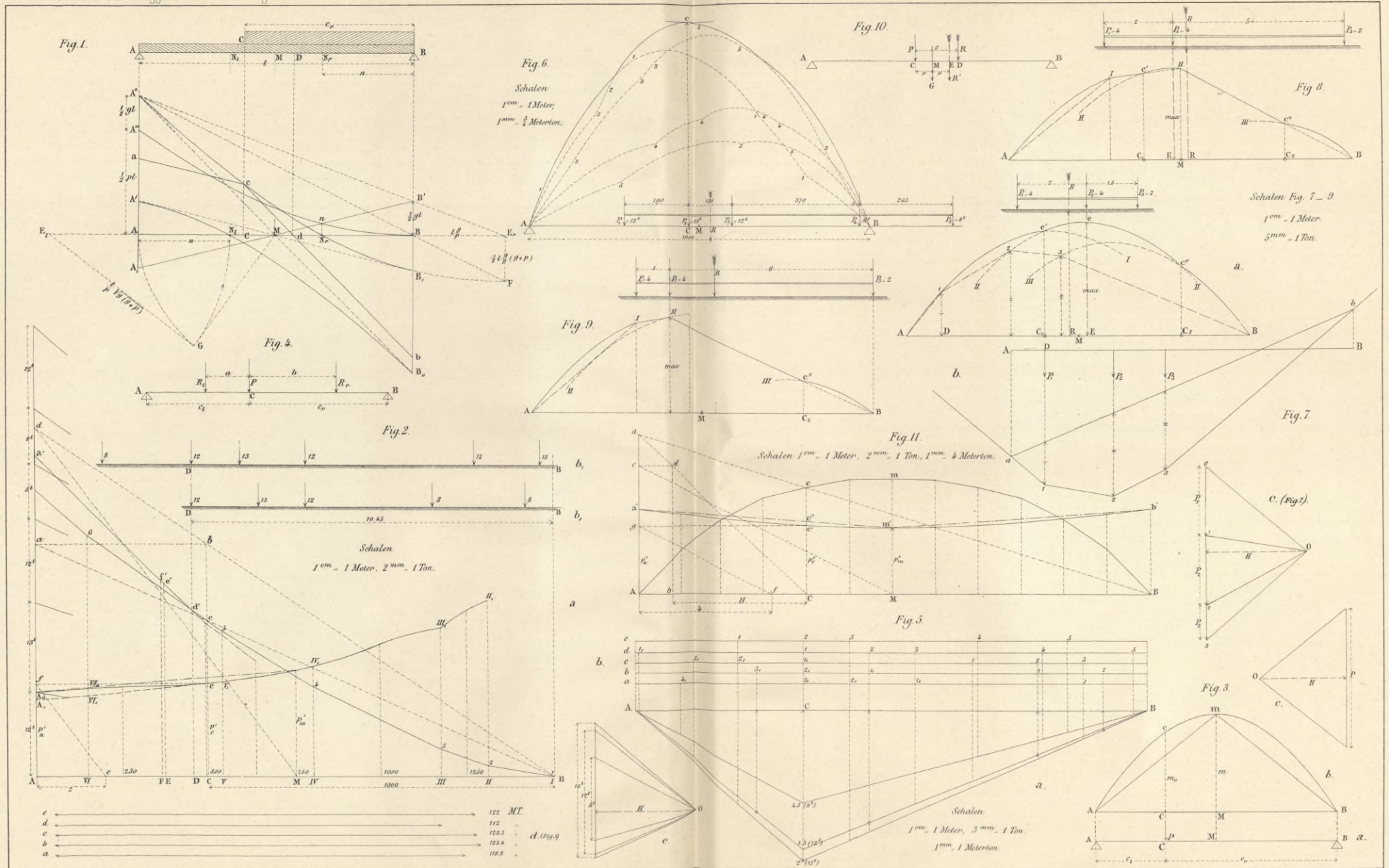

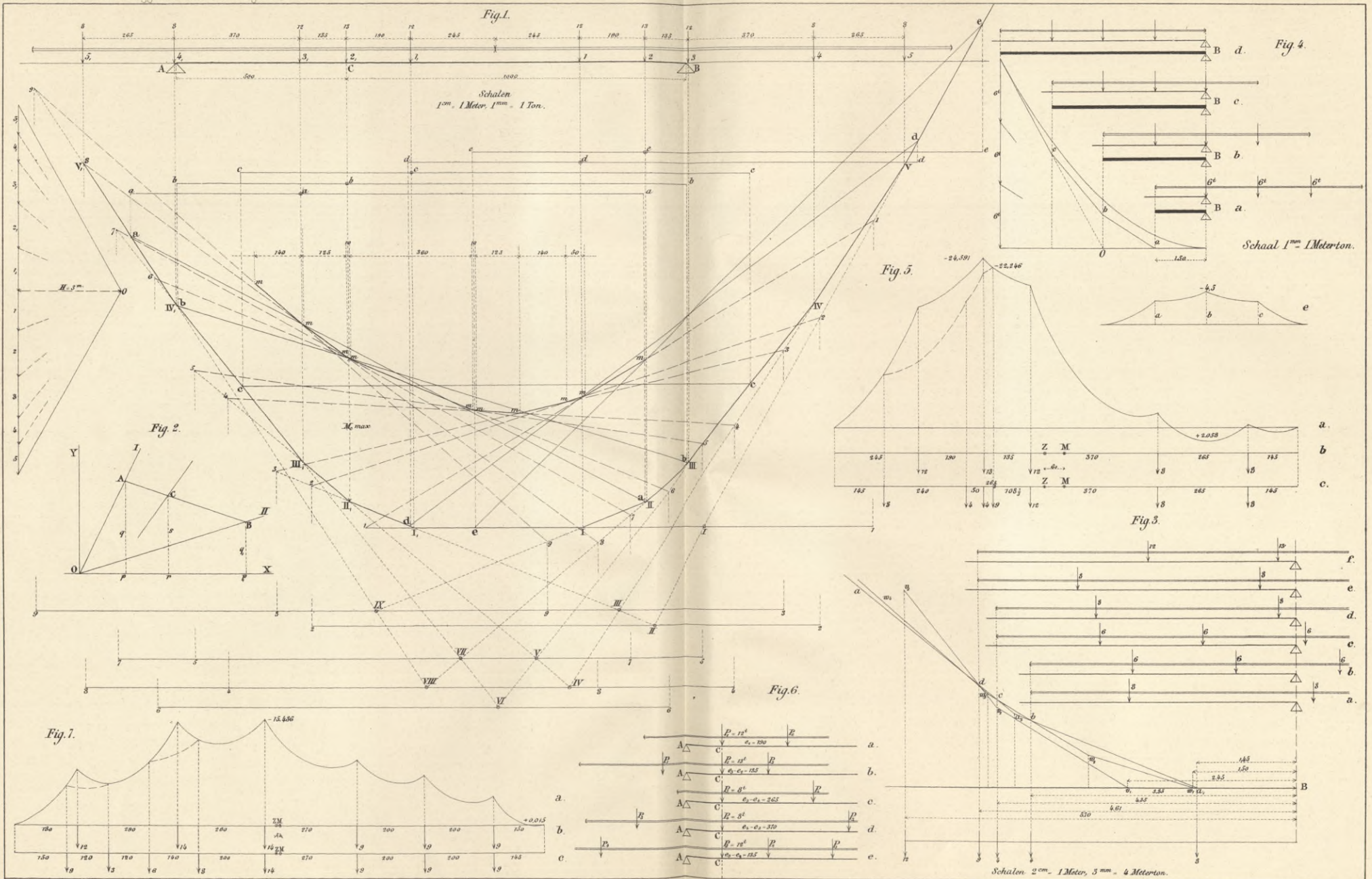

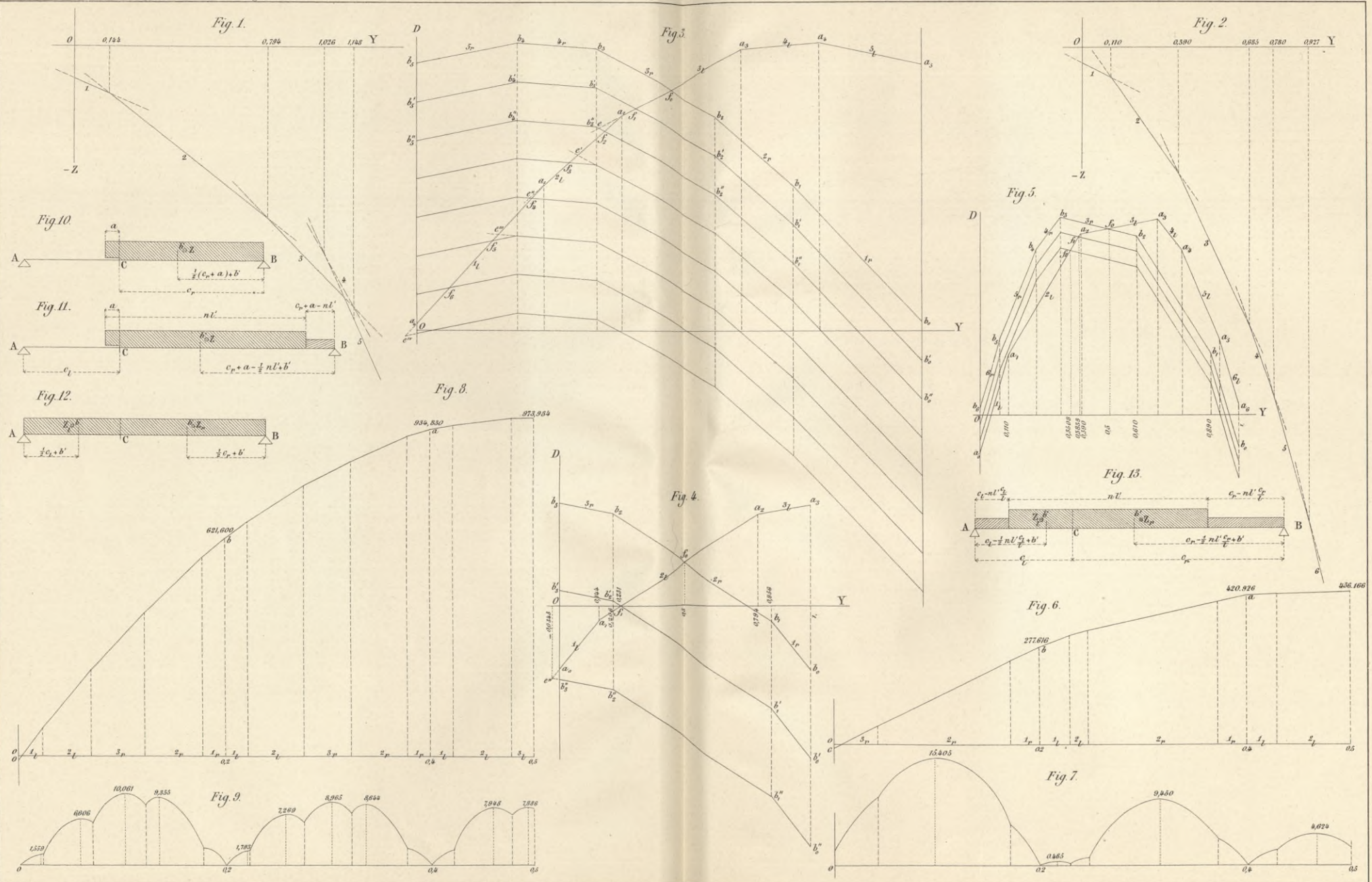

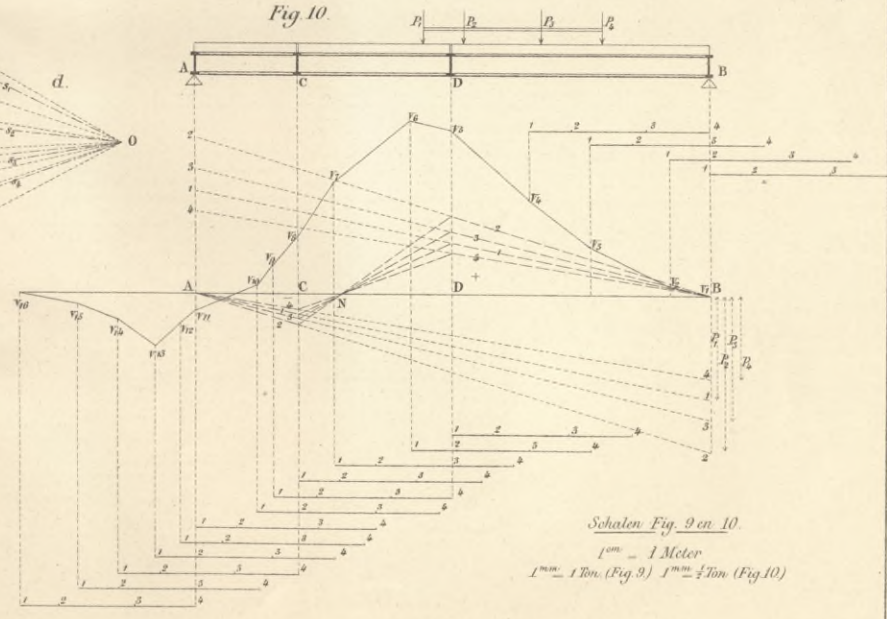
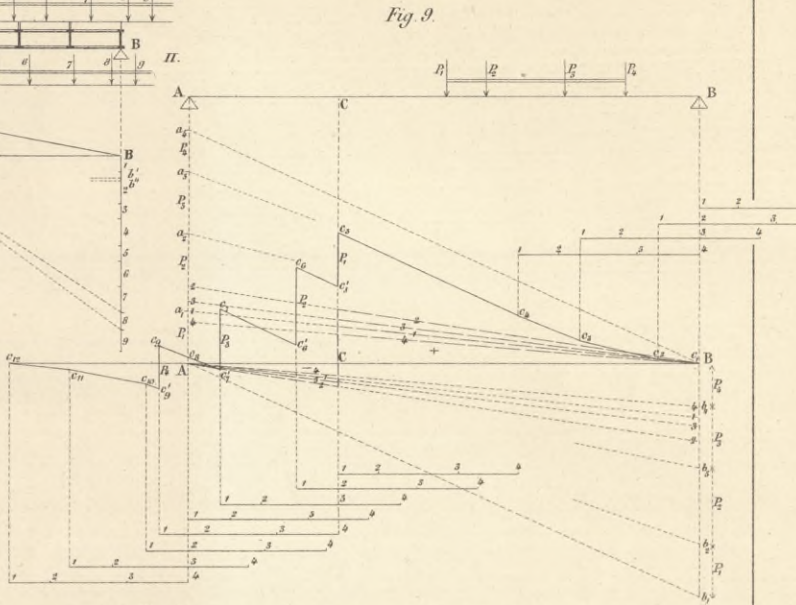
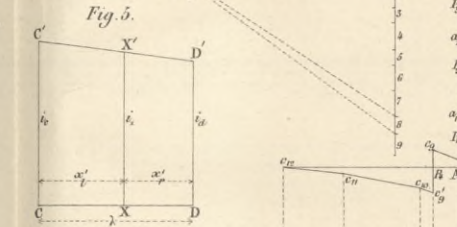
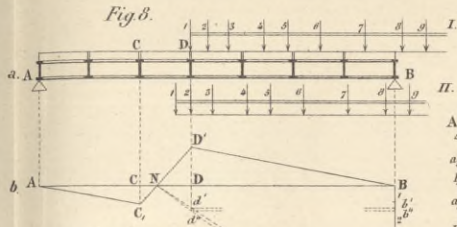
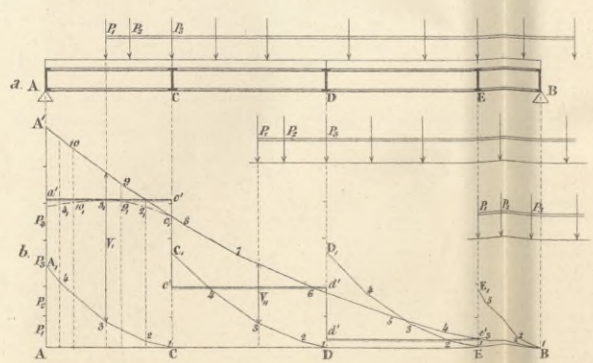
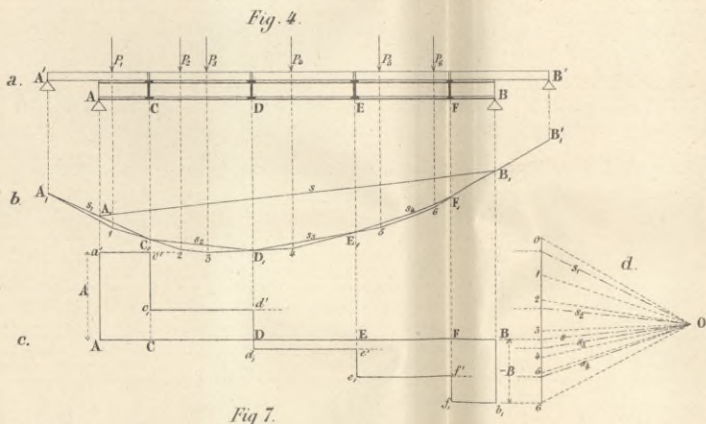
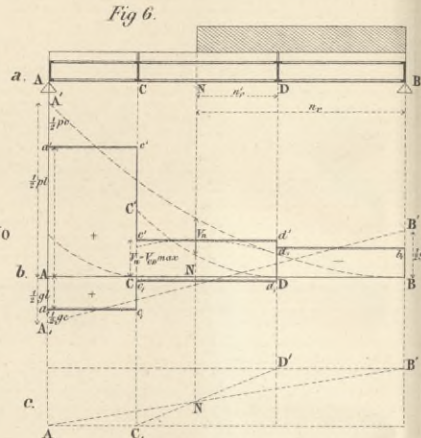
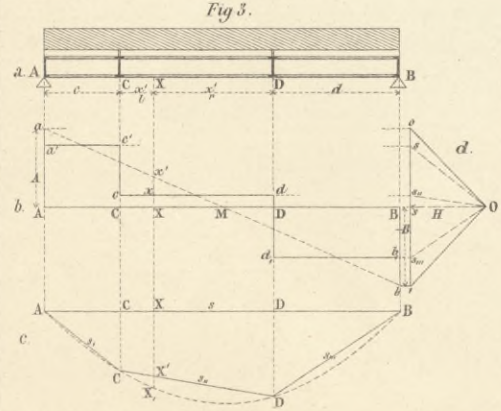
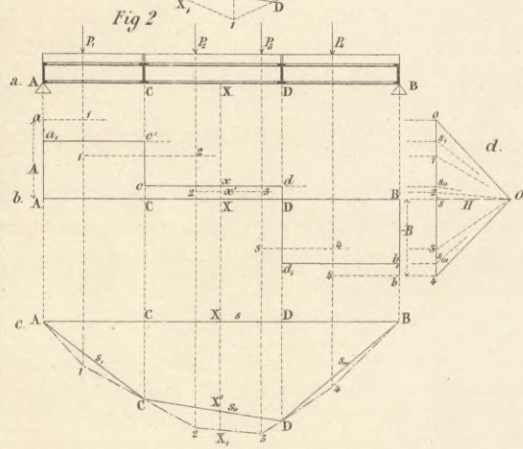
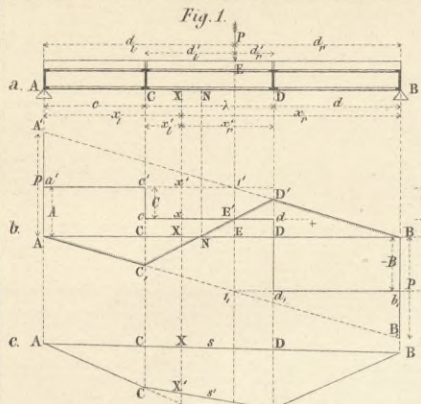

Schalen Fig. 9 en 10.
 1^{cm} = 1 Meter
 1^{mm} = 1 Ton. (Fig. 9) 1^{mm} = 1/2 Ton. (Fig. 10)

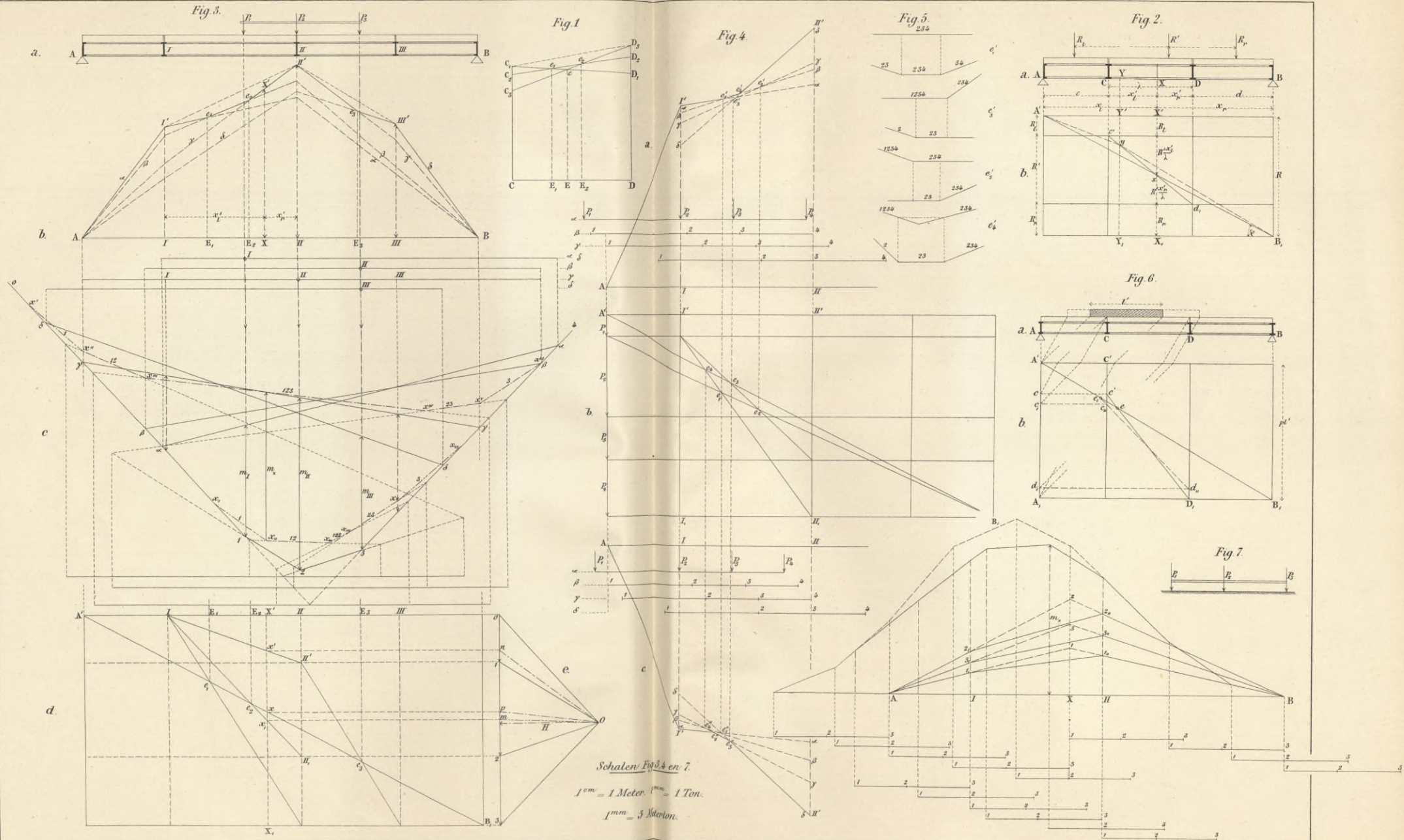

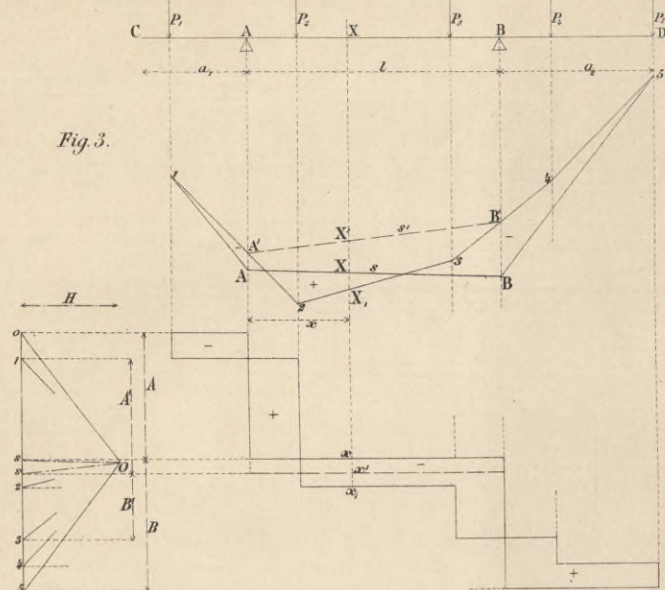

Fig. 3.

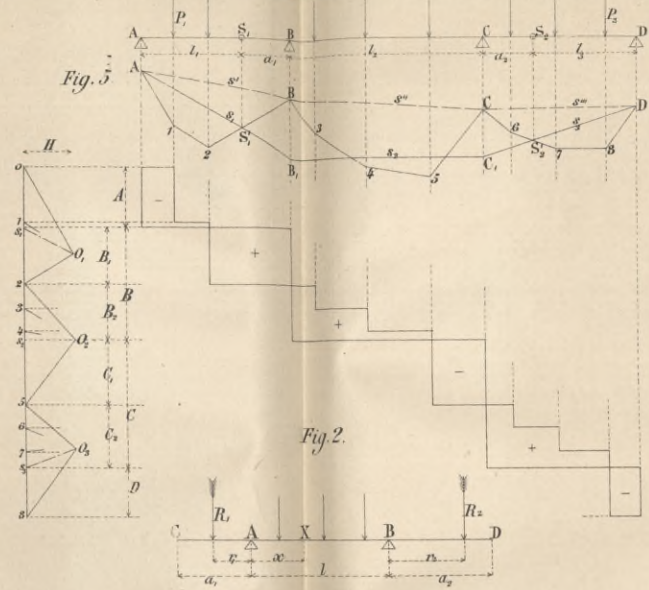

Fig. 5.

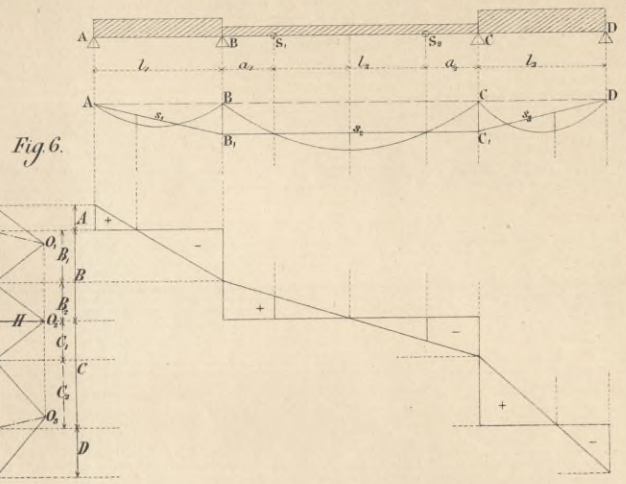

Fig. 6.

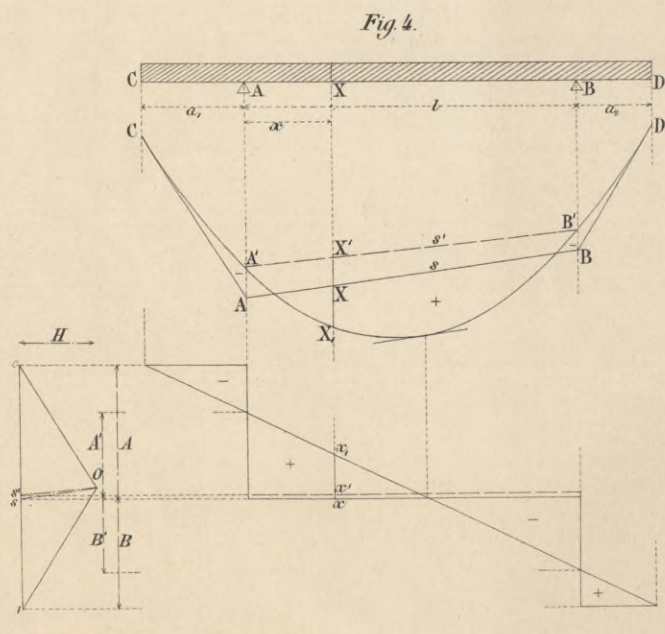

Fig. 4.

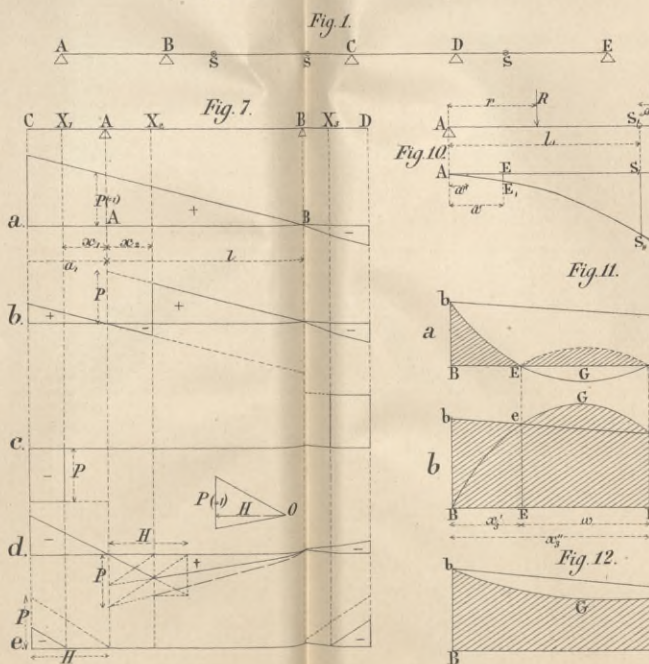

Fig. 7.

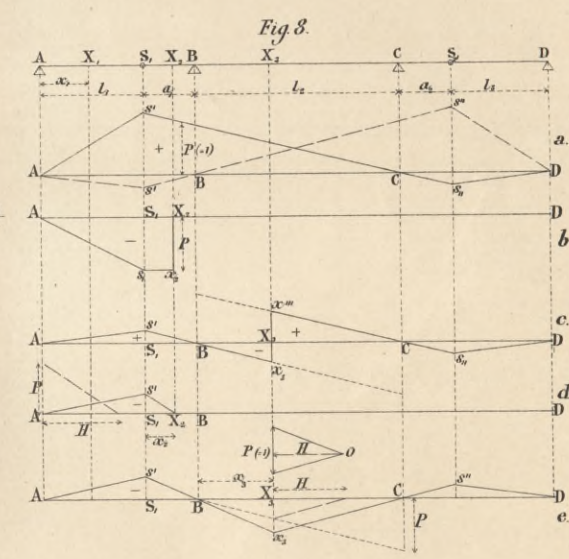

Fig. 8.

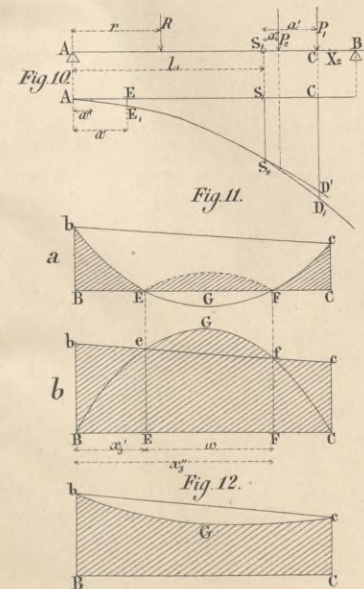

Fig. 10.

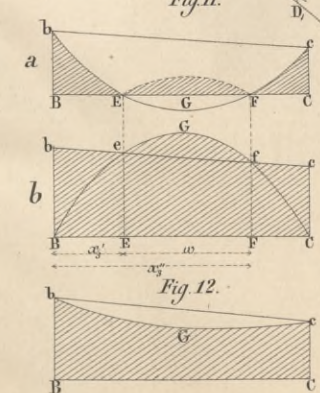

Fig. 11.

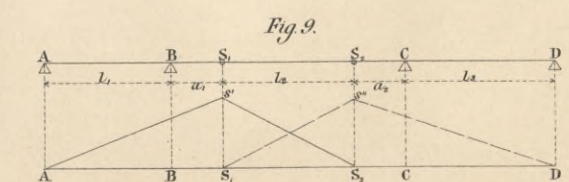

Fig. 9.

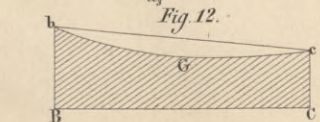

Fig. 12.

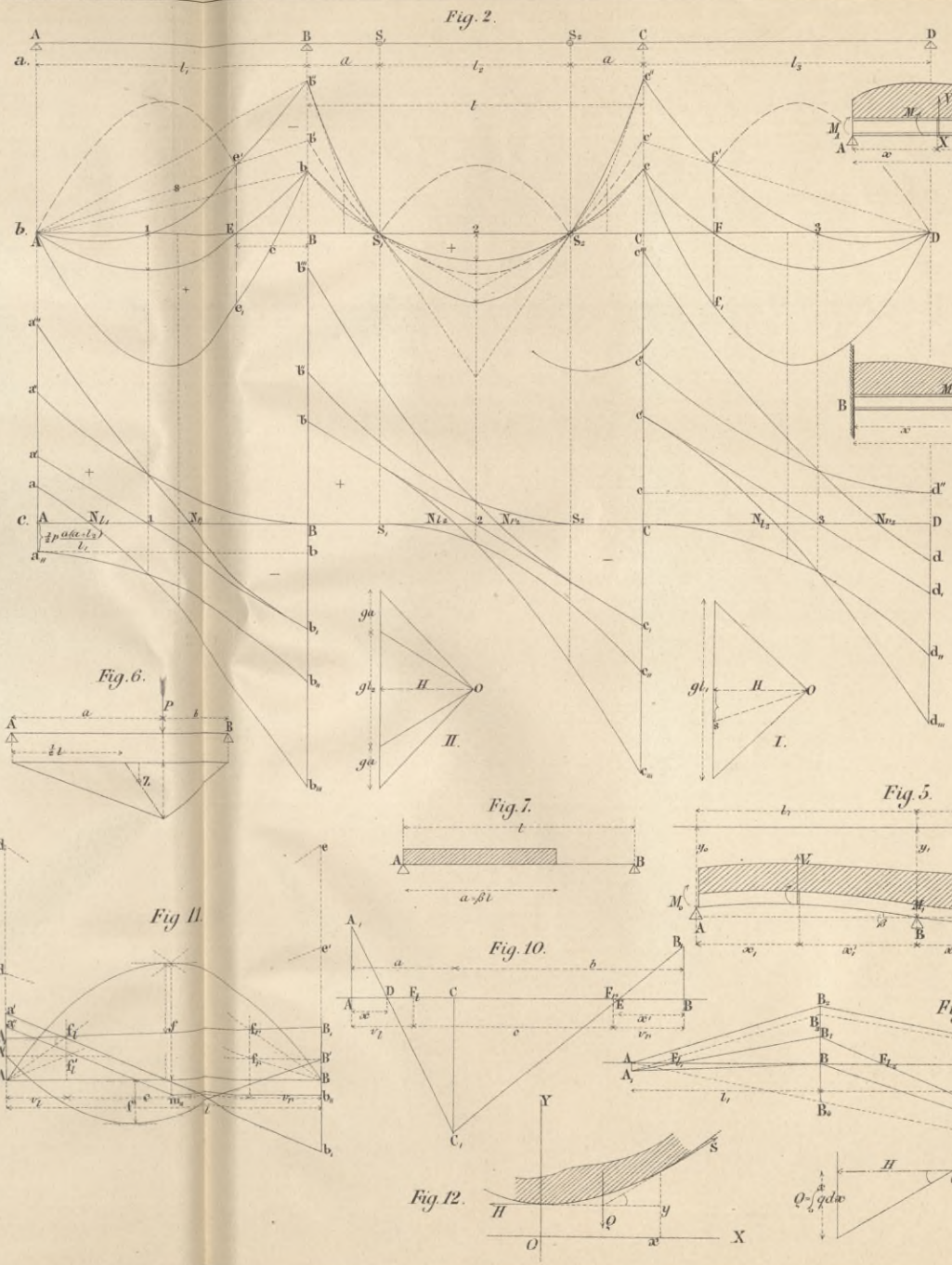
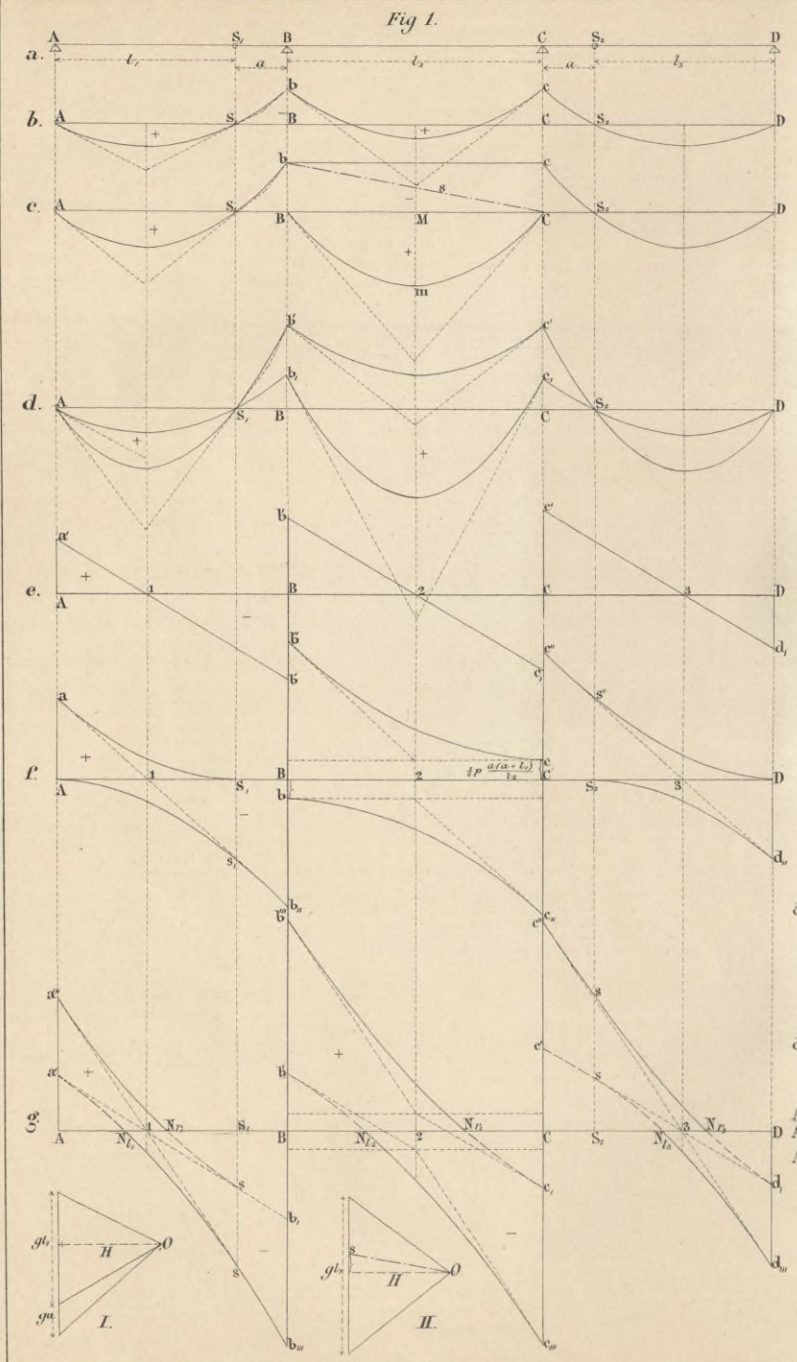

Fig. 1. (3/400)

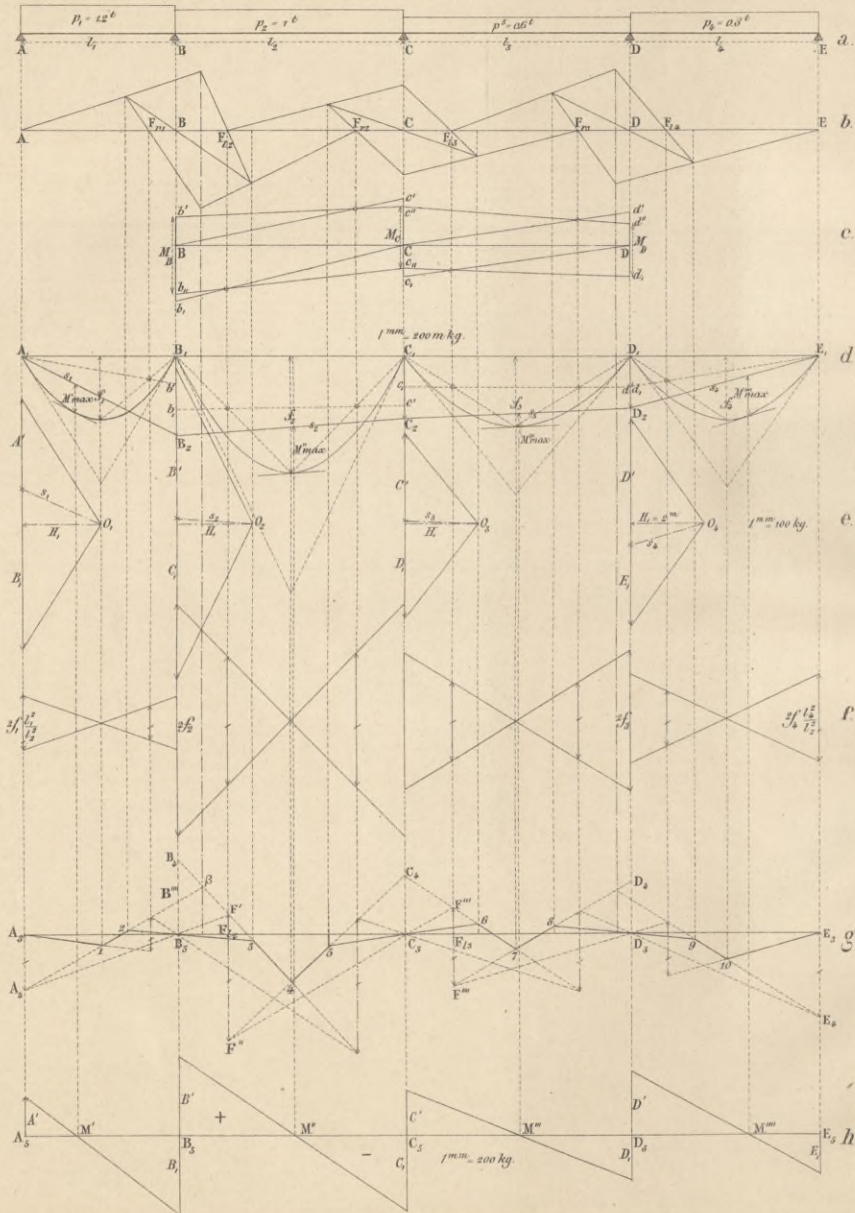

Fig. 2.

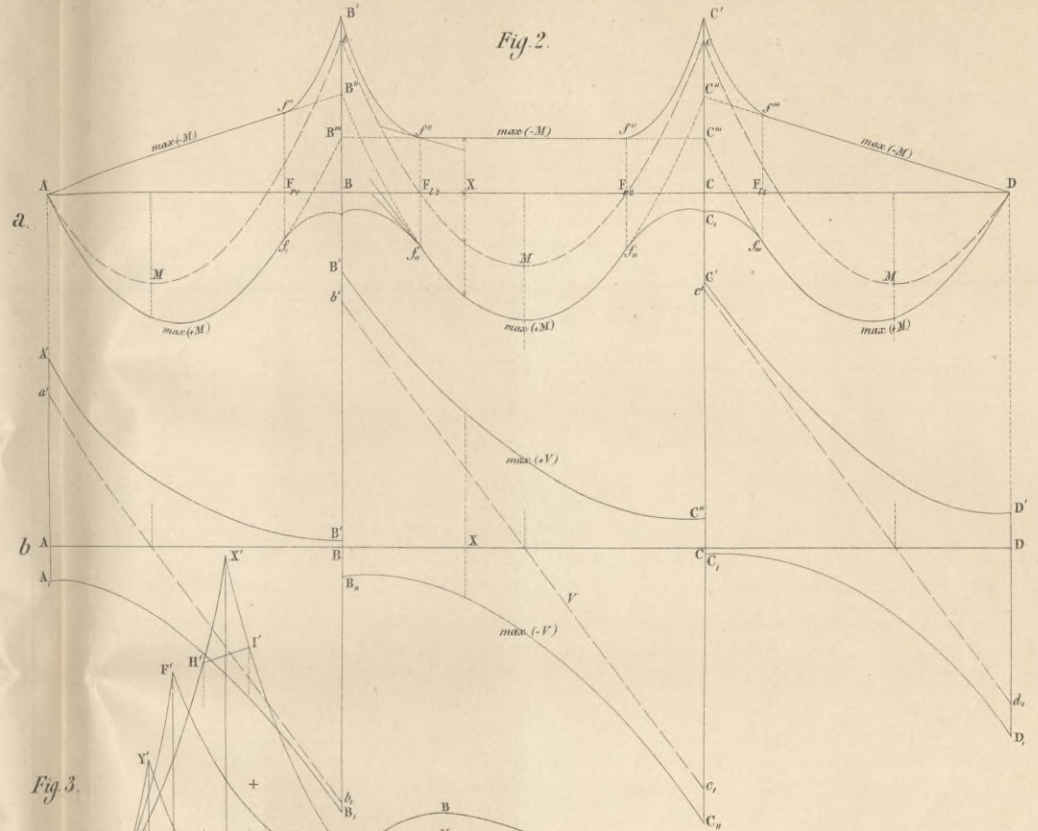

Fig. 3.

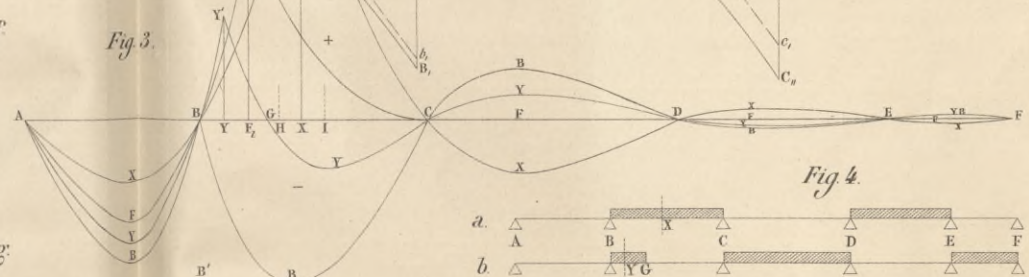

Fig. 4.

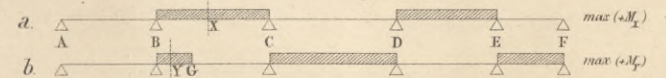

Fig. 5.

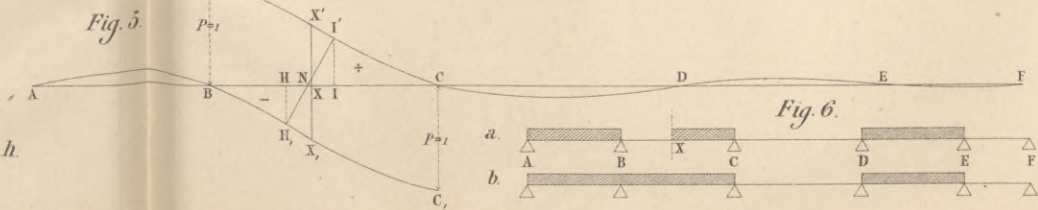
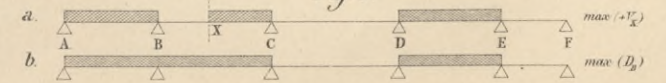
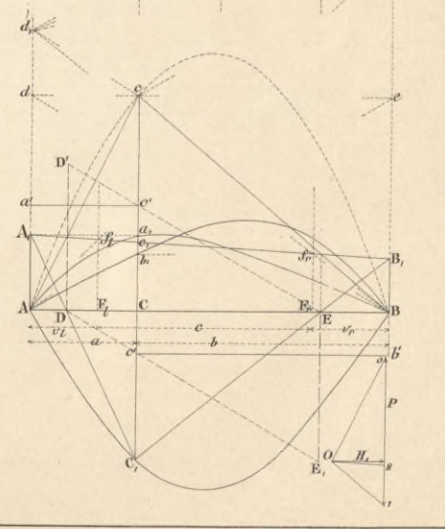
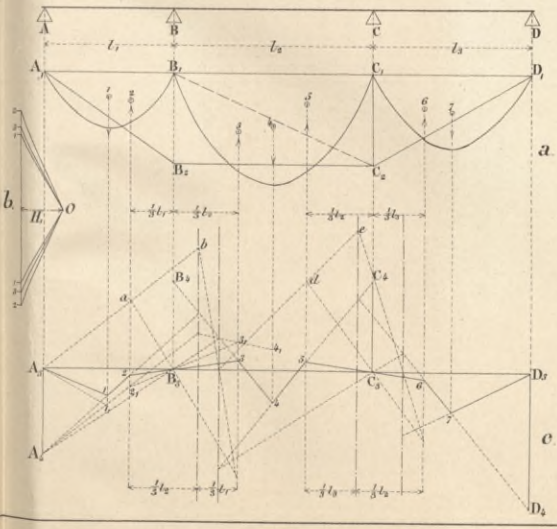
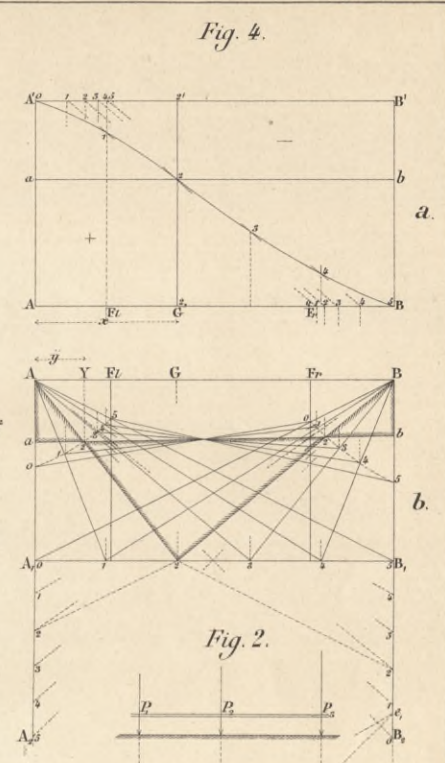
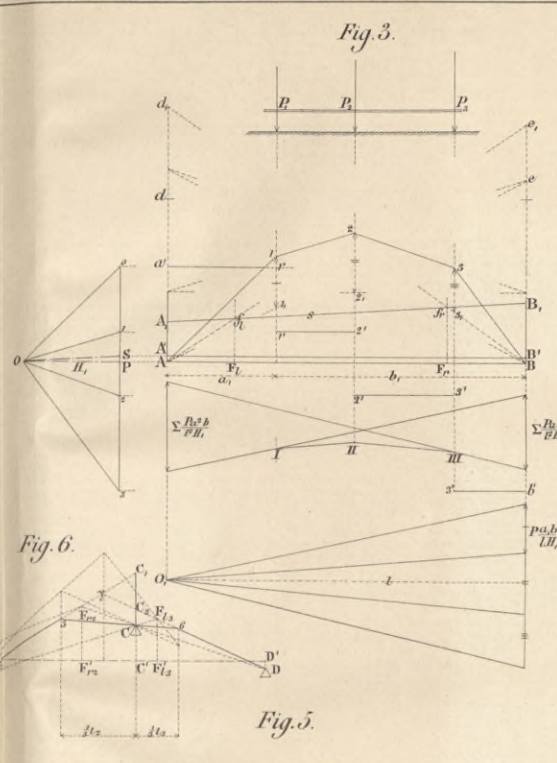
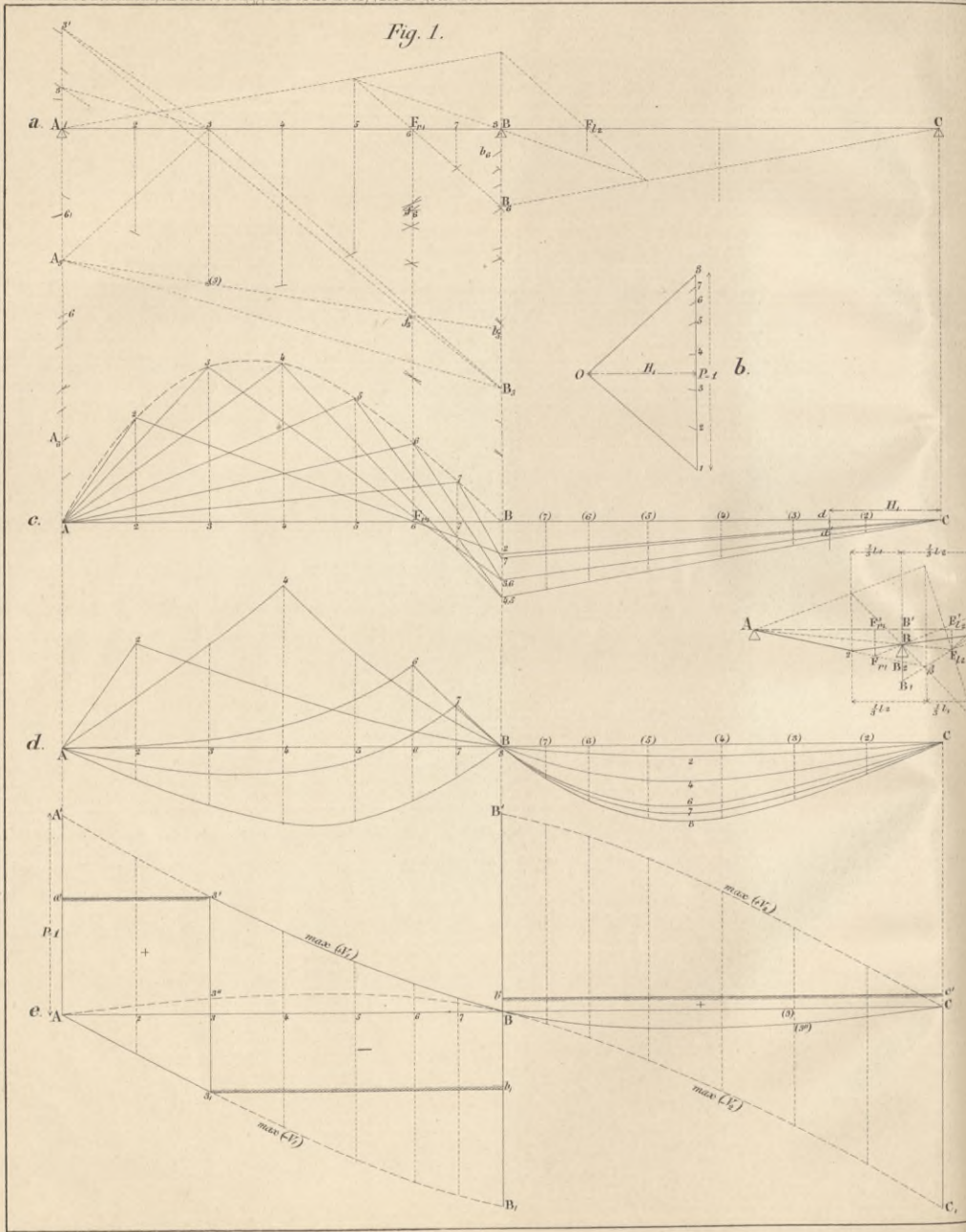
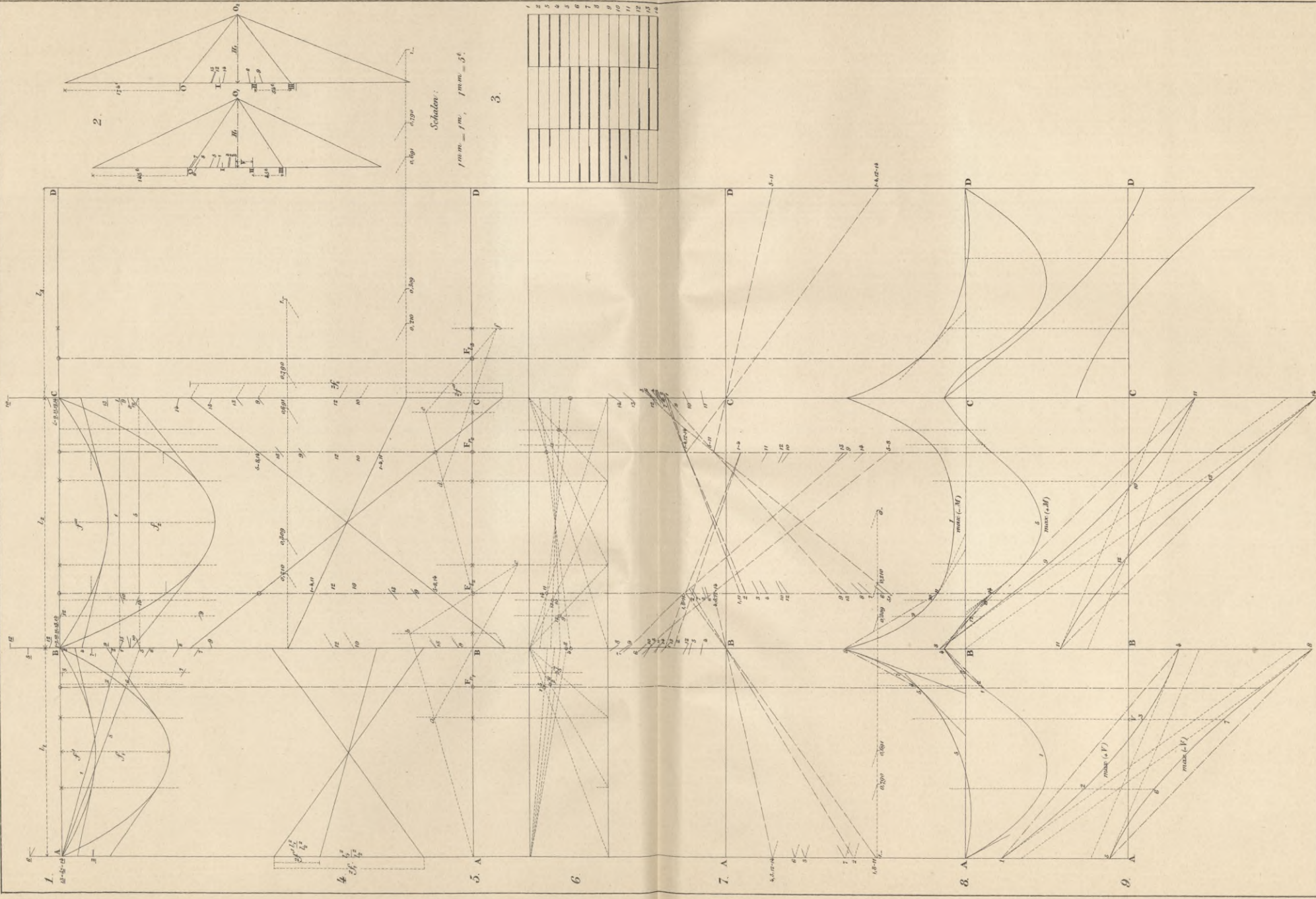
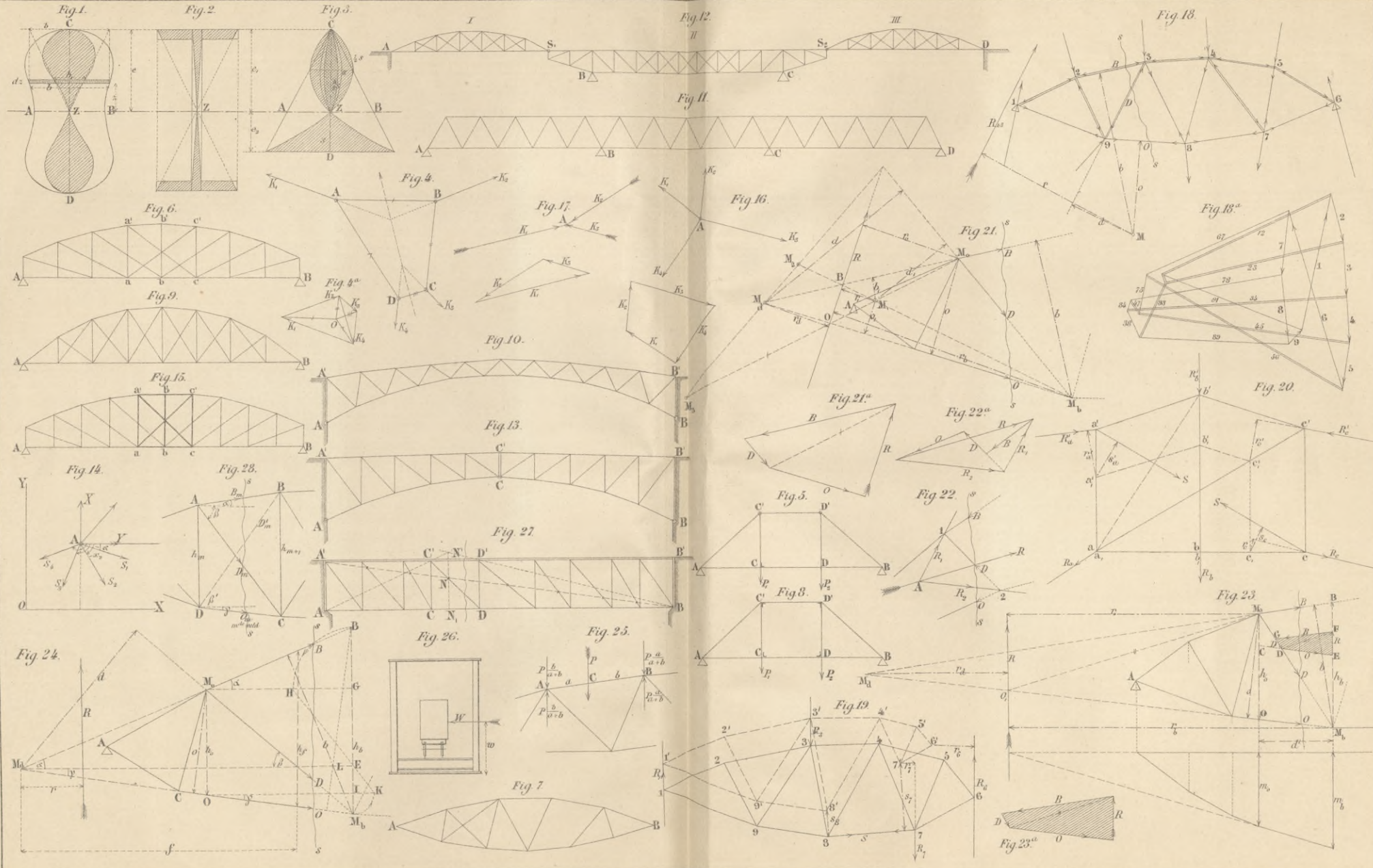

Fig. 6.









Brug over den Rijn bij Rhenen.

Schaal 1:300

Belasting: $g_k = 27 \times 3750 \text{ kg.} - g_r = 5/7 \times 3750 \text{ kg. p. m.}$

$P_k = 3750 \text{ kg p. m.}$

Methoden van Ritter en van Mohr.

Schaal 2 mm = 3 ton

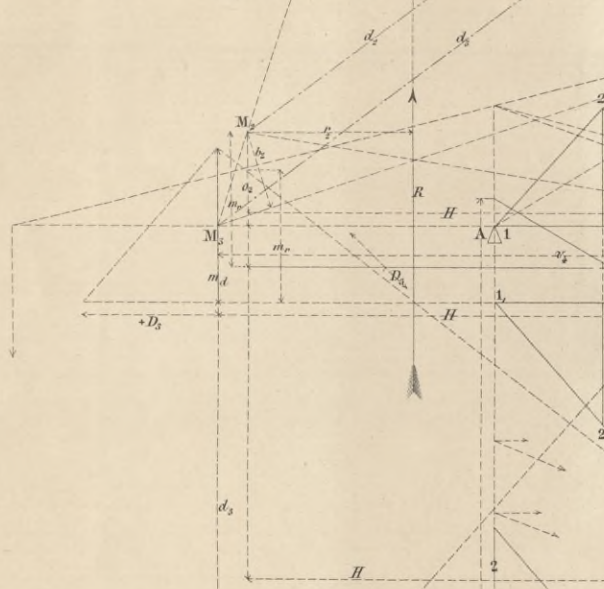
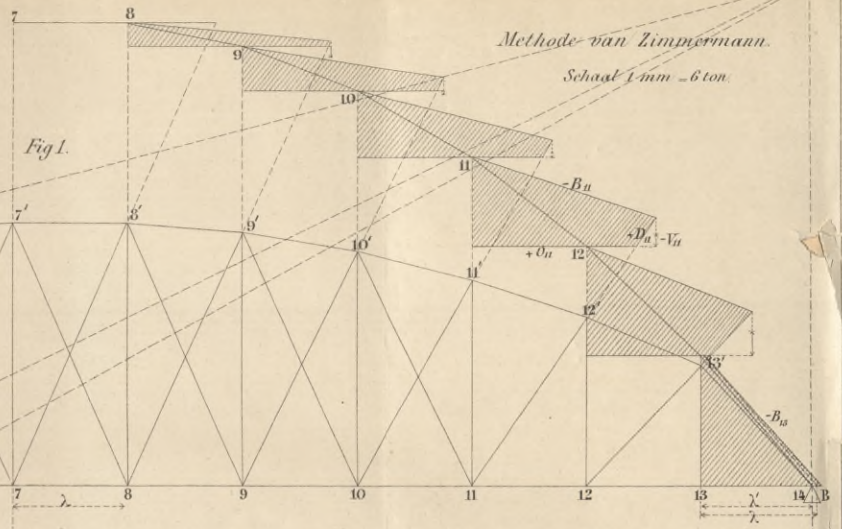

Fig. 1.

Methode van Zimmermann.

Schaal 1 mm = 6 ton.



Methode van Culmann.

Schaal 2 mm = 3 ton.

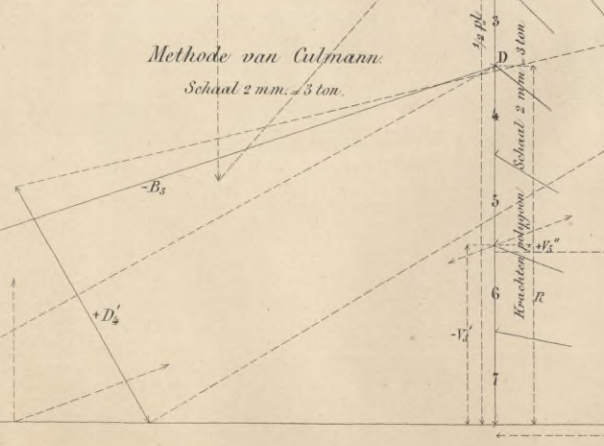
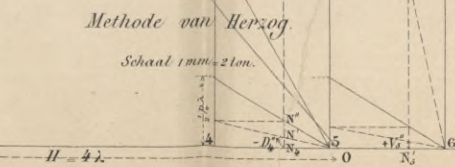

Fig. 3.

Methode van Herzog.

Schaal 1 mm = 2 ton.



Methode van Cremona.

Schaal 2 mm = 3 ton.

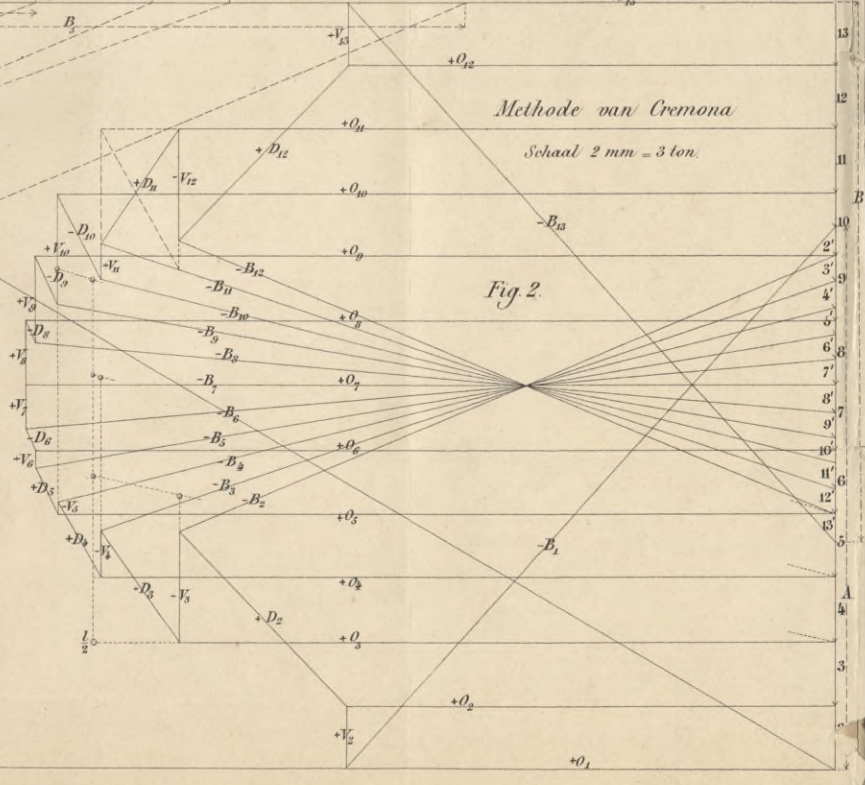
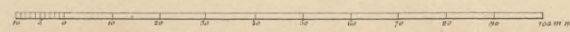
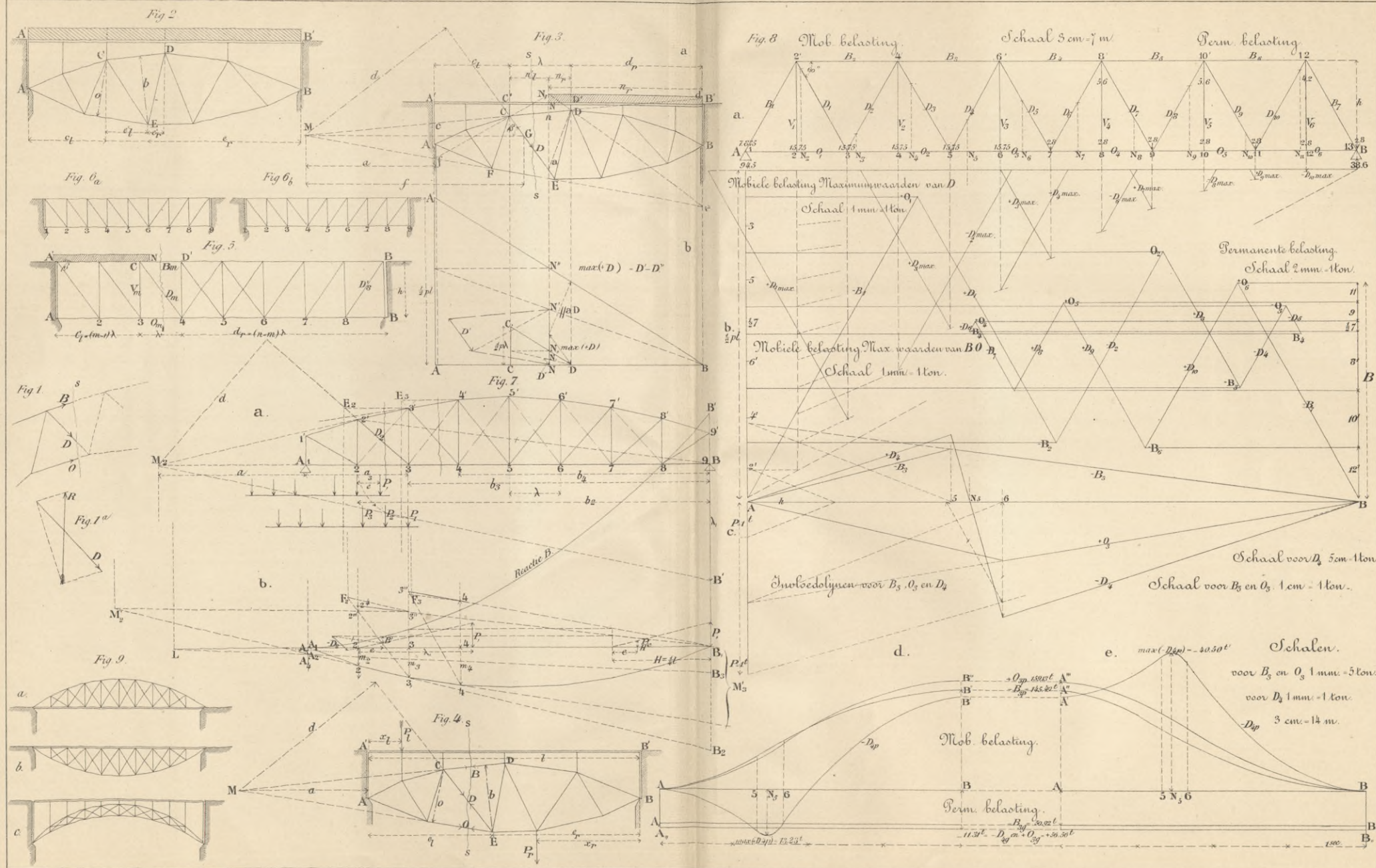

Fig. 2.





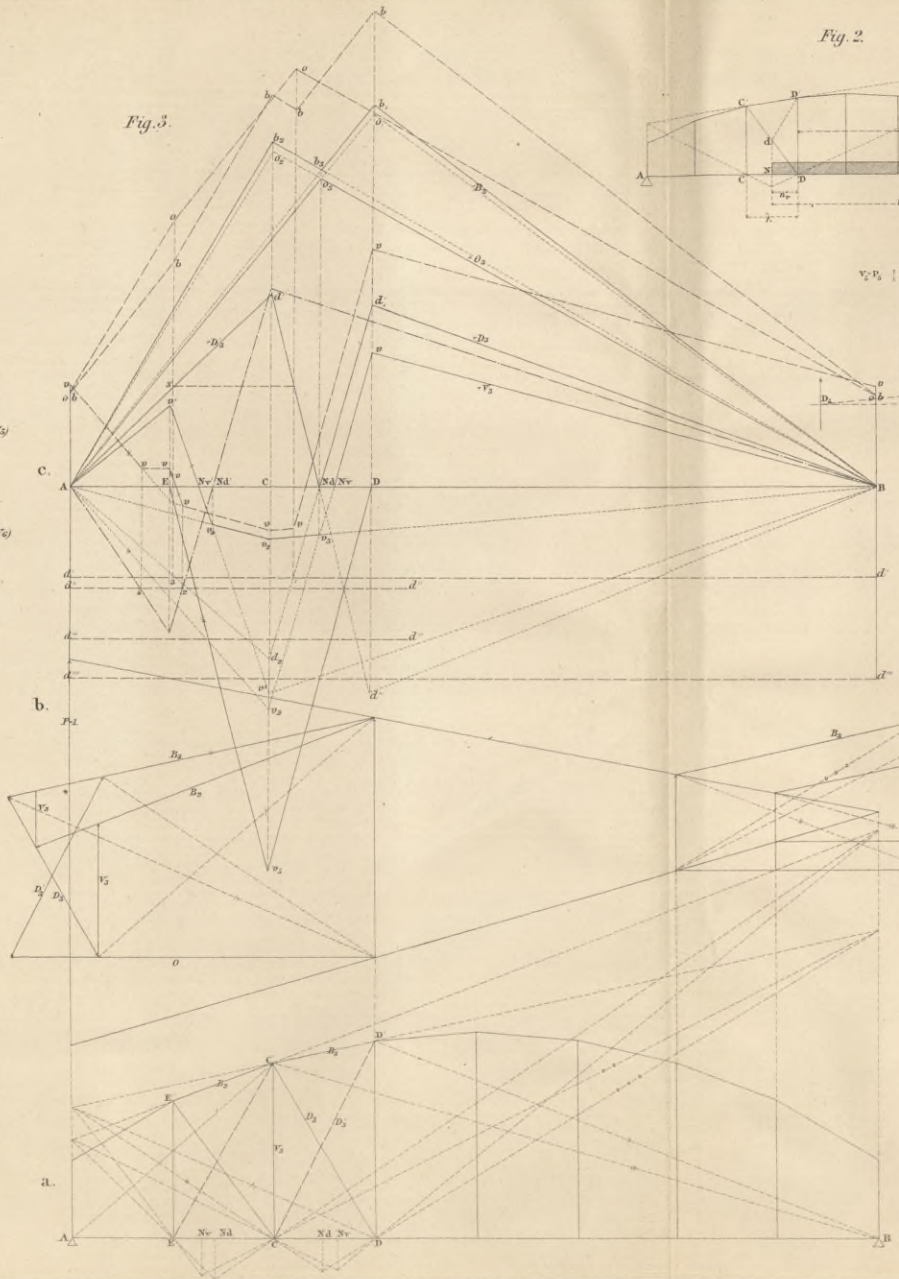
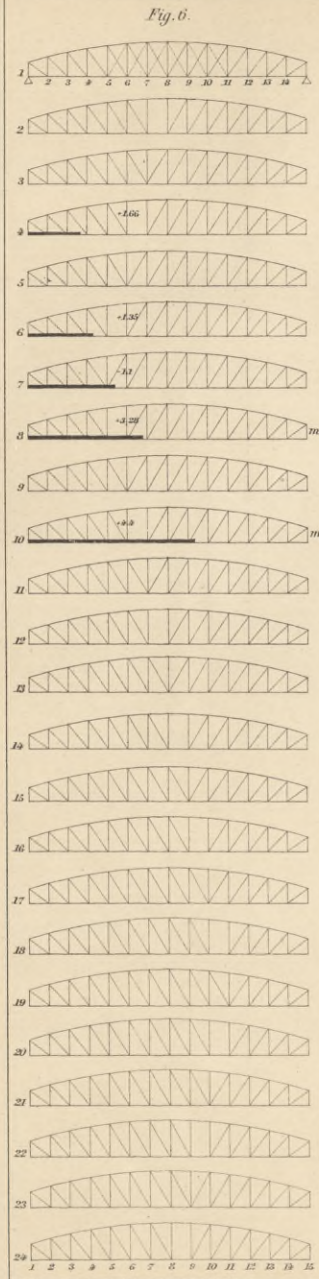

Fig. 2.

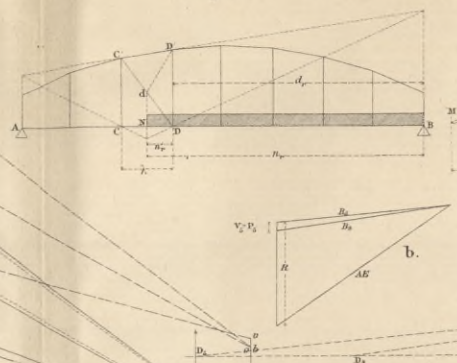

Fig. 1.

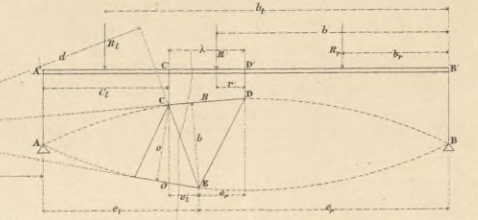

Fig. 5.

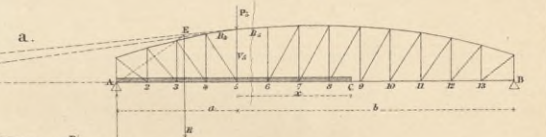

Fig. 8.

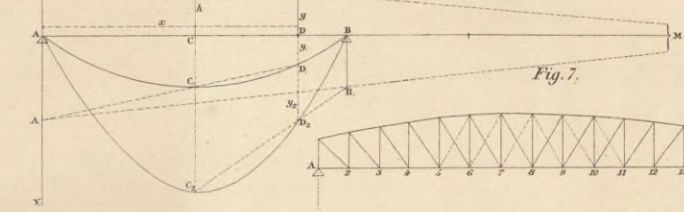

Fig. 7.

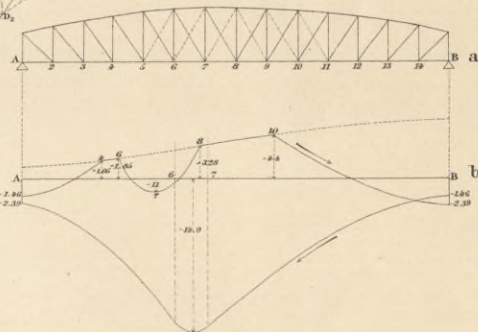

Fig. 9.

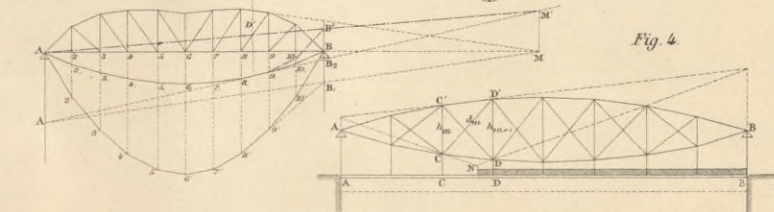

Fig. 4.

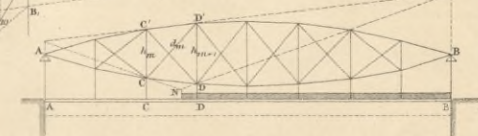
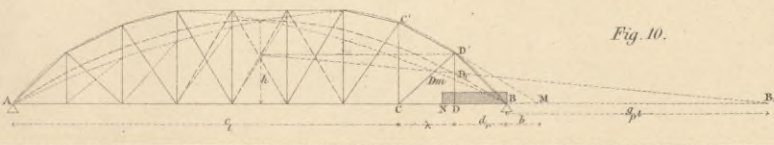

Fig. 10.



Brug over den Rijn bij Rhenen. Schaal 1:300.

Maximum Krachten in de Randen

Schaal 1^{mm} = 2 ton.

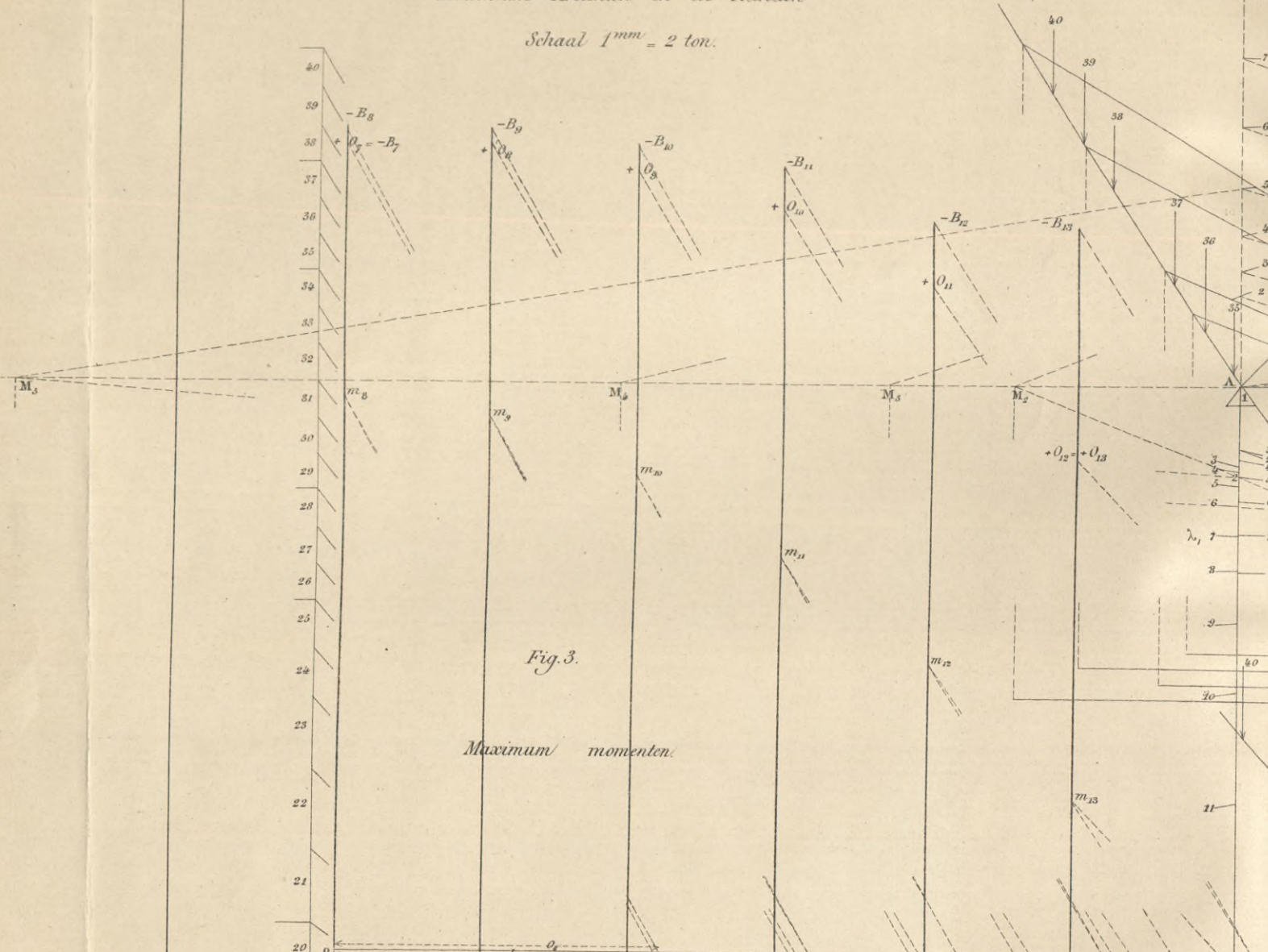

Fig. 3.

Maximum momenten.

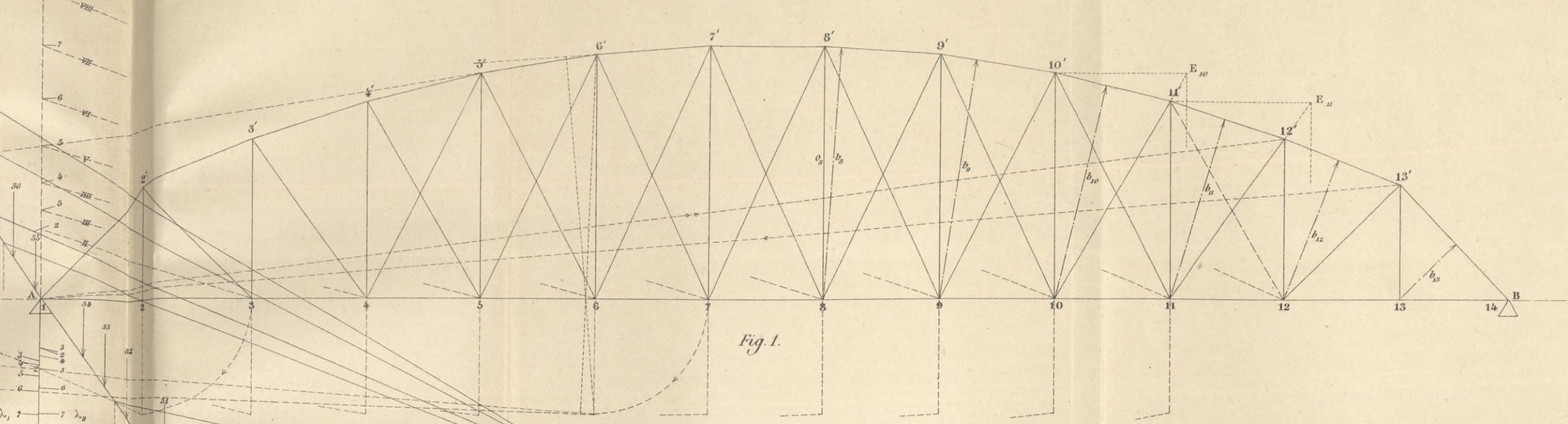

Fig. 1.

Maximum Krachten in de Diagonalen en Verticalen.

Schaal 2^{mm} = 1 ton.

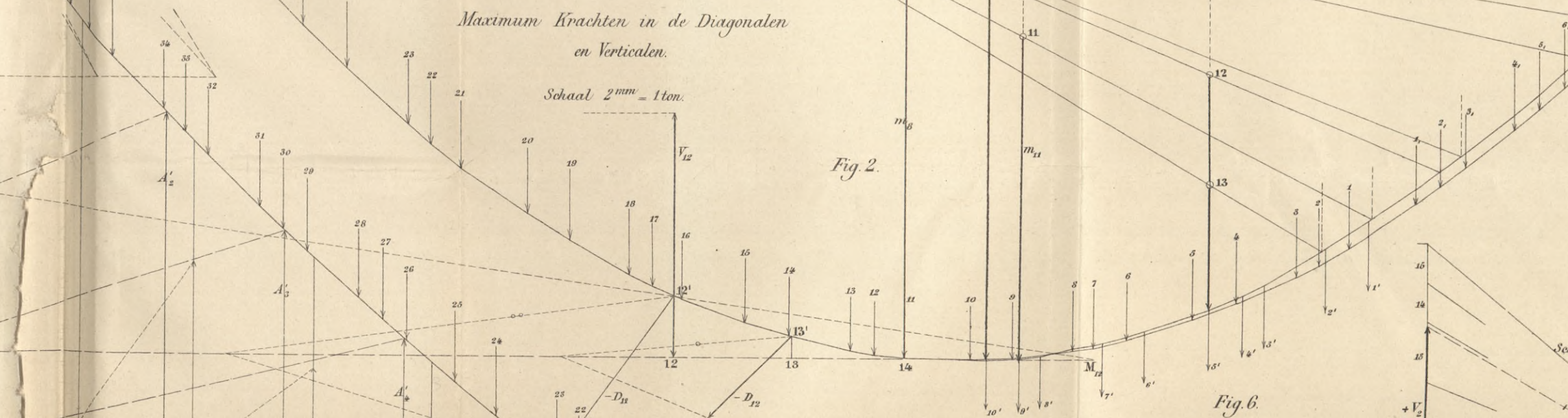

Fig. 2.

Maximum Krachten in de Diagonalen en Verticalen.

Schaal 1^{mm} = 1 ton.

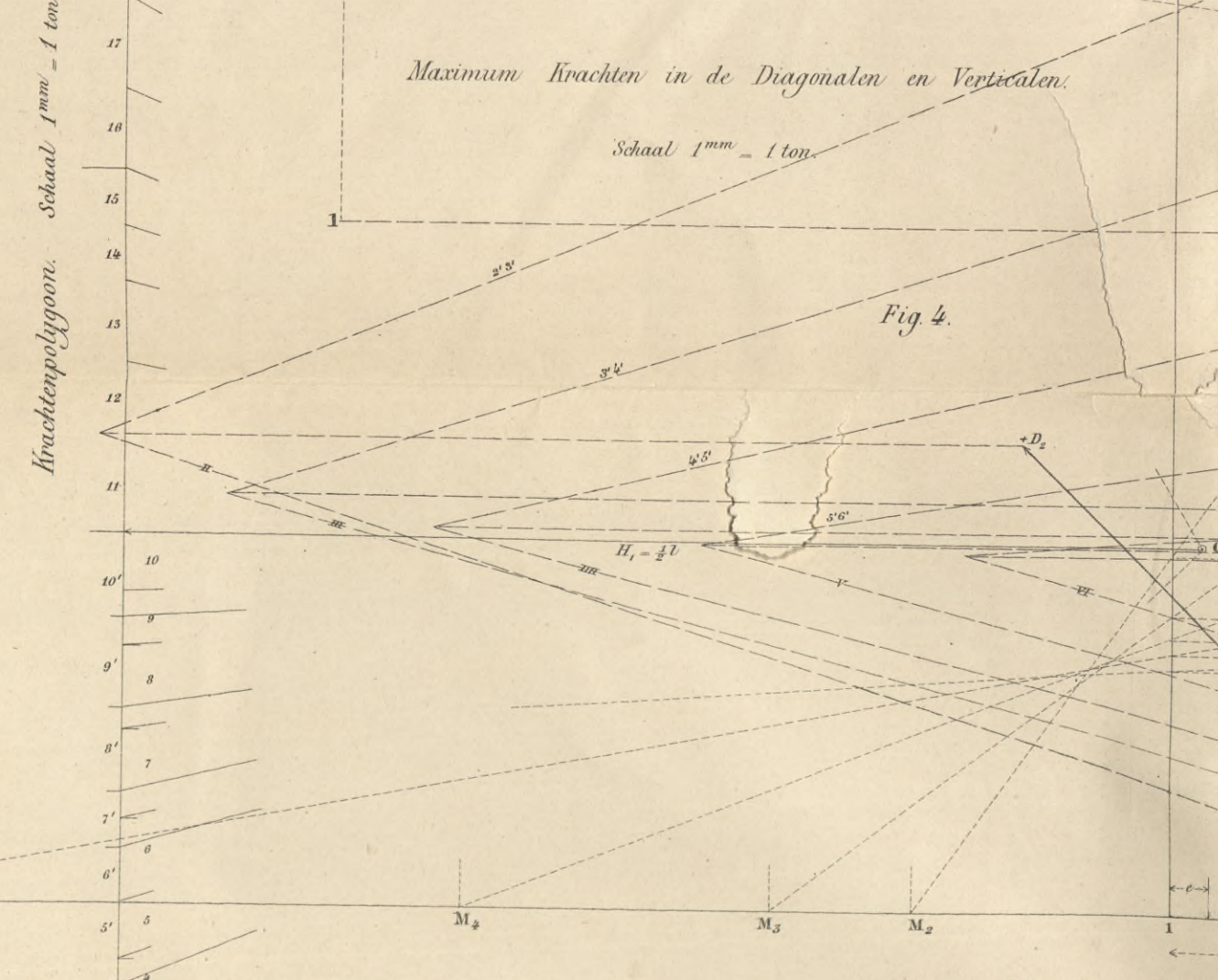

Fig. 4.

Maximum momenten.

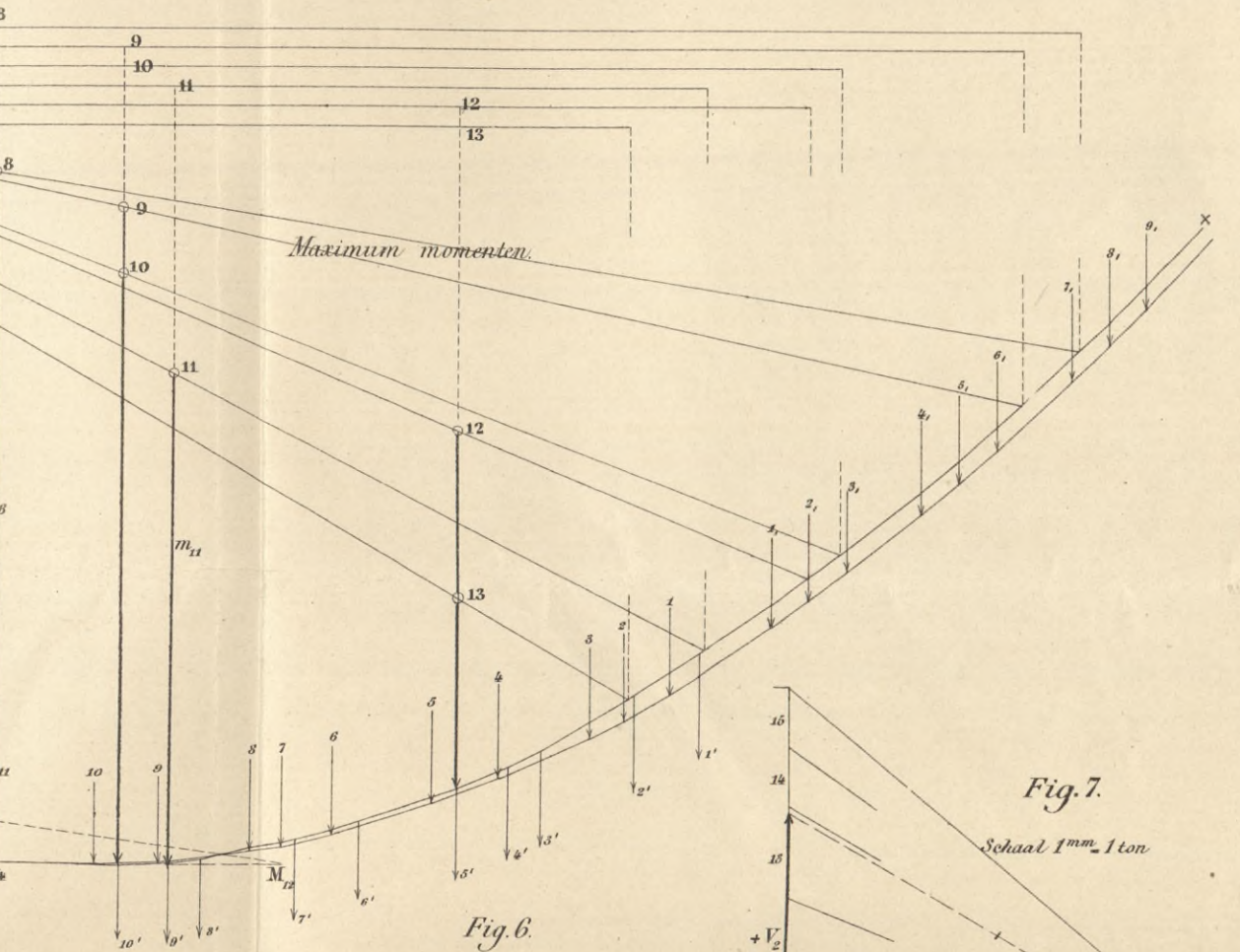

Fig. 6.

Fig. 7.

Schaal 1^{mm} = 1 ton.

Krachtenpolygoon. Schaal 1^{mm} = 1 ton.

Secundaire Krachten polygoon.

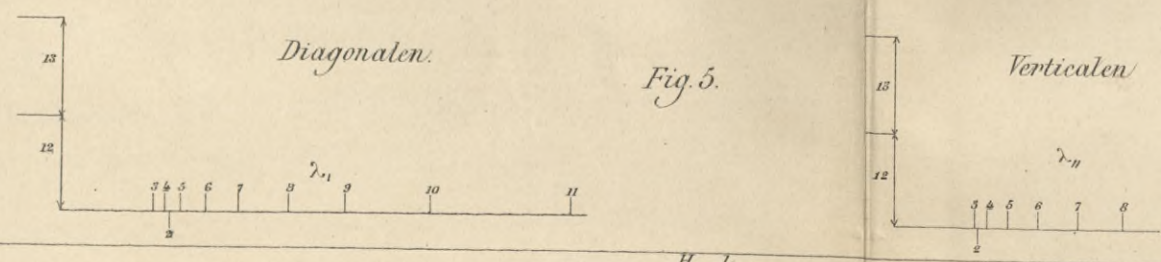
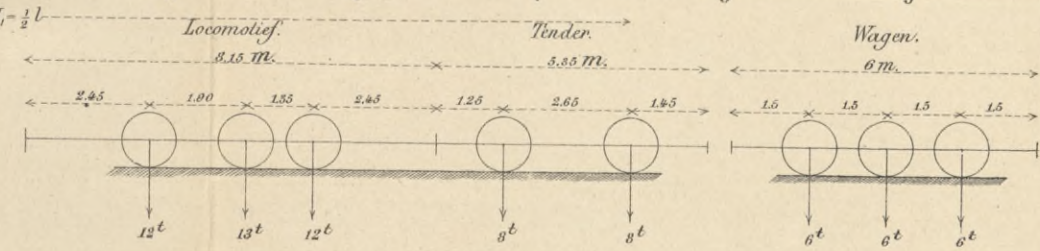
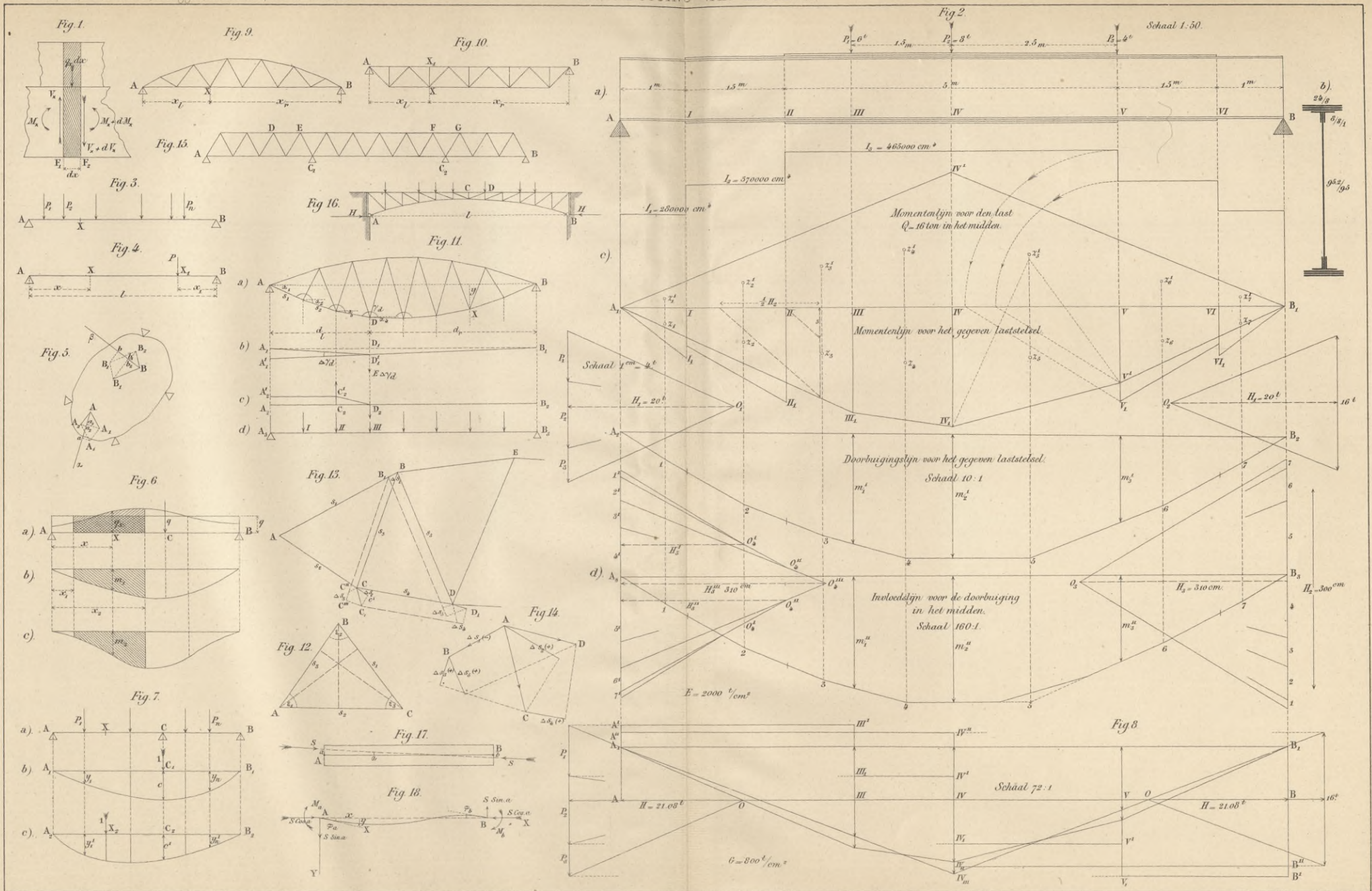
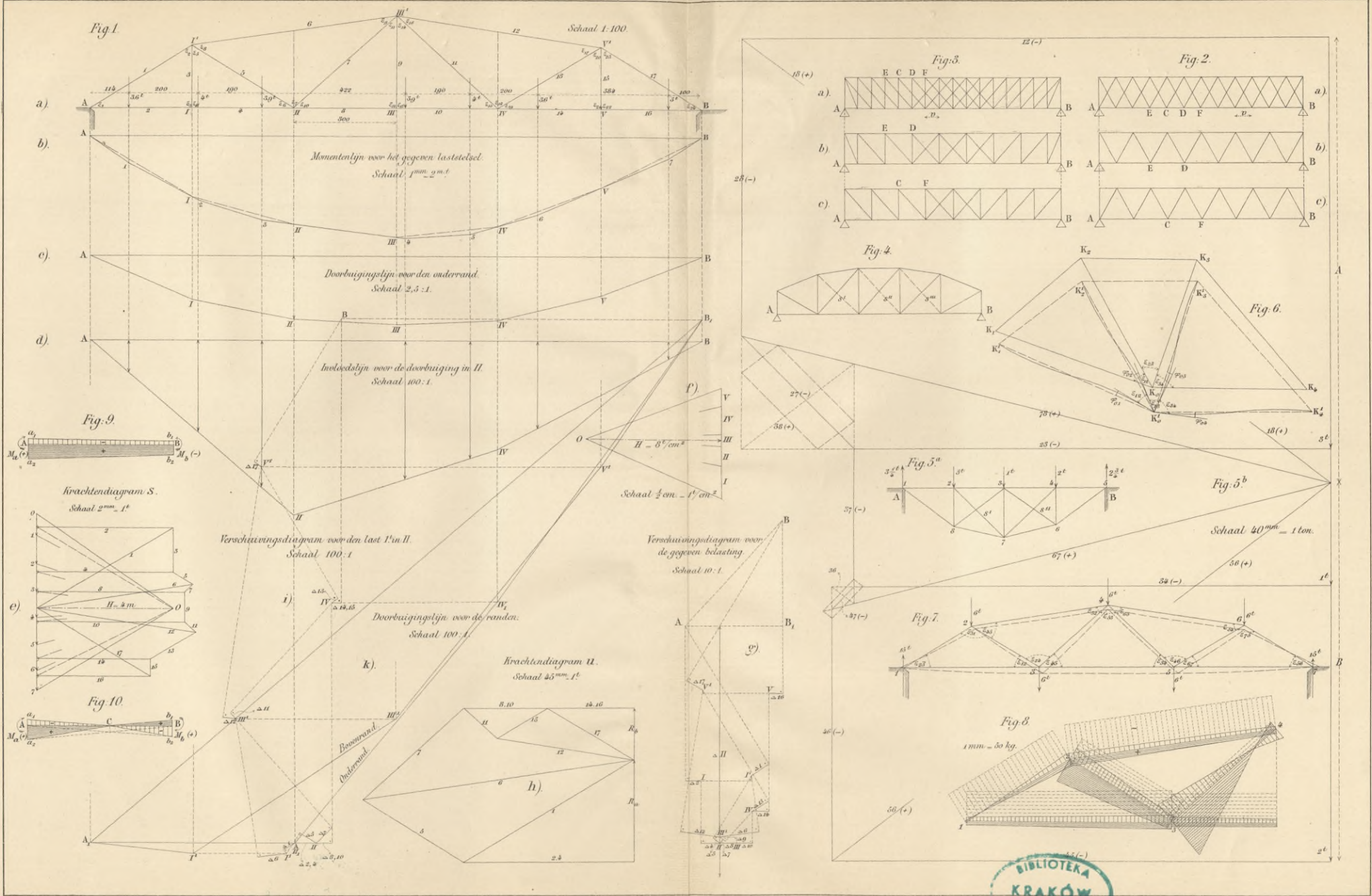

Fig. 5.







WYDZIAŁY POLITECHNICZNE KRAKÓW

BIBLIOTEKA GŁÓWNA

Biblioteka Politechniki Krakowskiej



IV-300960

ruk. U. J. Zam. 356. 10.000.

Biblioteka Politechniki Krakowskiej



100000300938