

Biblioteka Politechniki Krakowskiej

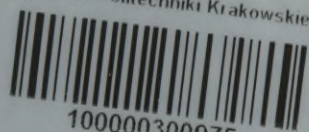

100000300975



x
2.314

Kupfertafeln

zum

Handbuch der Wasserbaukunst

von

G. Hagen.

Erster Theil:

Die Quellen.

Dritte, neu bearbeitete Auflage.

Brunnen, Wasserleitungen

und

Fundierungen.

Erster und Zweiter Band.

(Tafel I bis XXIII.)

Manus. sub Litt. D. I. No. 334

Berlin 1870.

Verlag von Ernst & Korn.

(Gropius'sche Buch- und Kunsthandlung.)

x
2314



~~III 18316~~



III-306401

Handwritten signature or text, possibly 'L. ...'

Akc. Nr. ~~1255/52~~ 4PK-B-300/2017

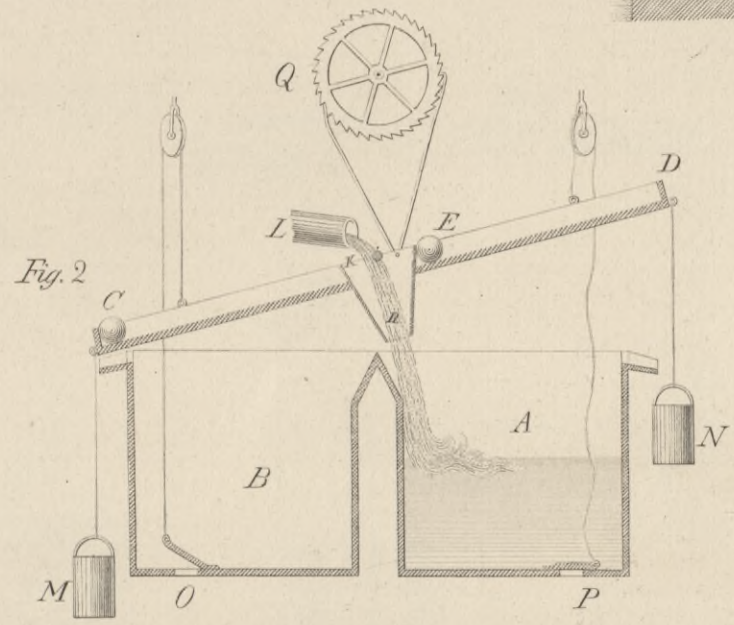
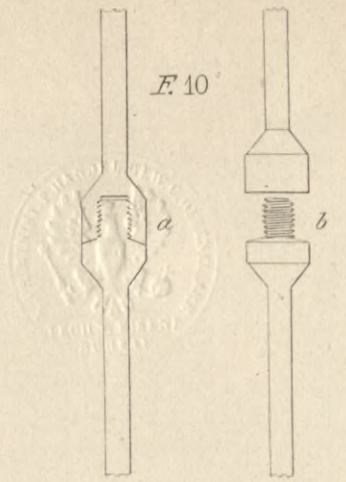
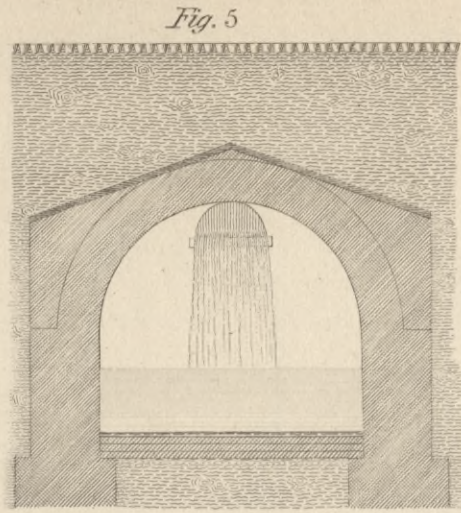
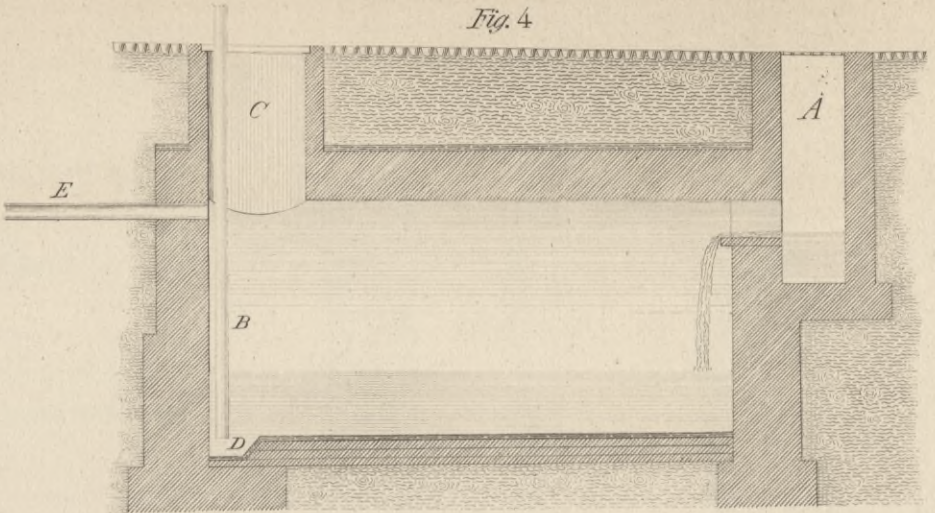
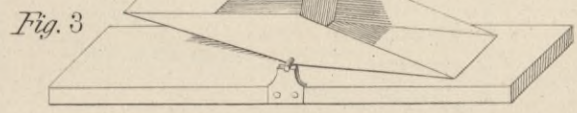
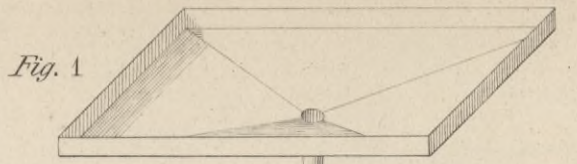

10 5 0 5 10 Fuss. zu Fig. 4, 5 und 9.

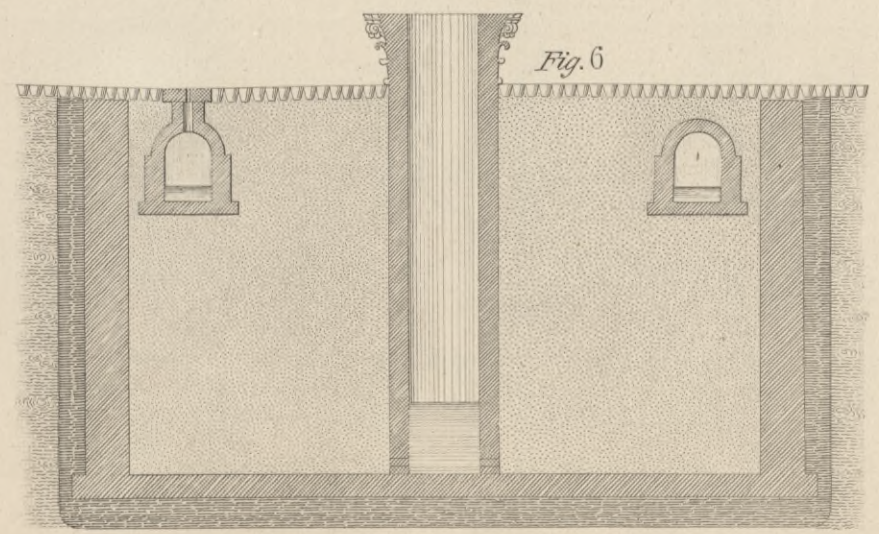
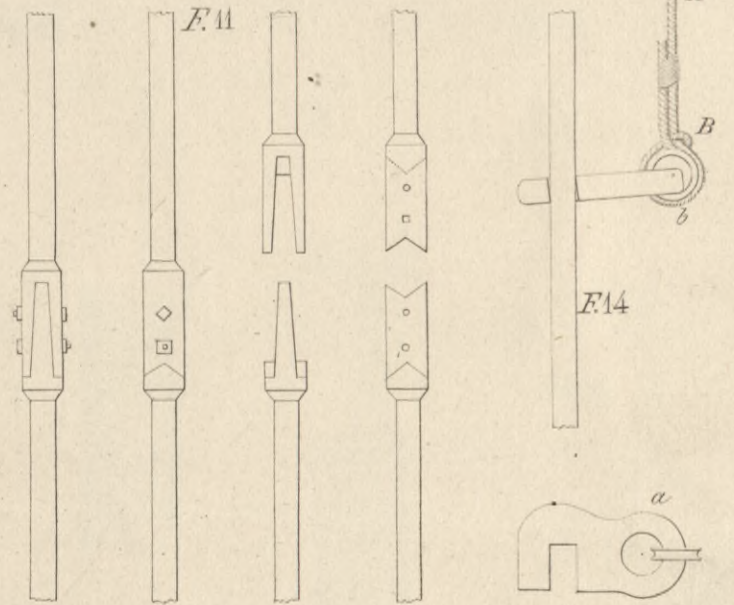
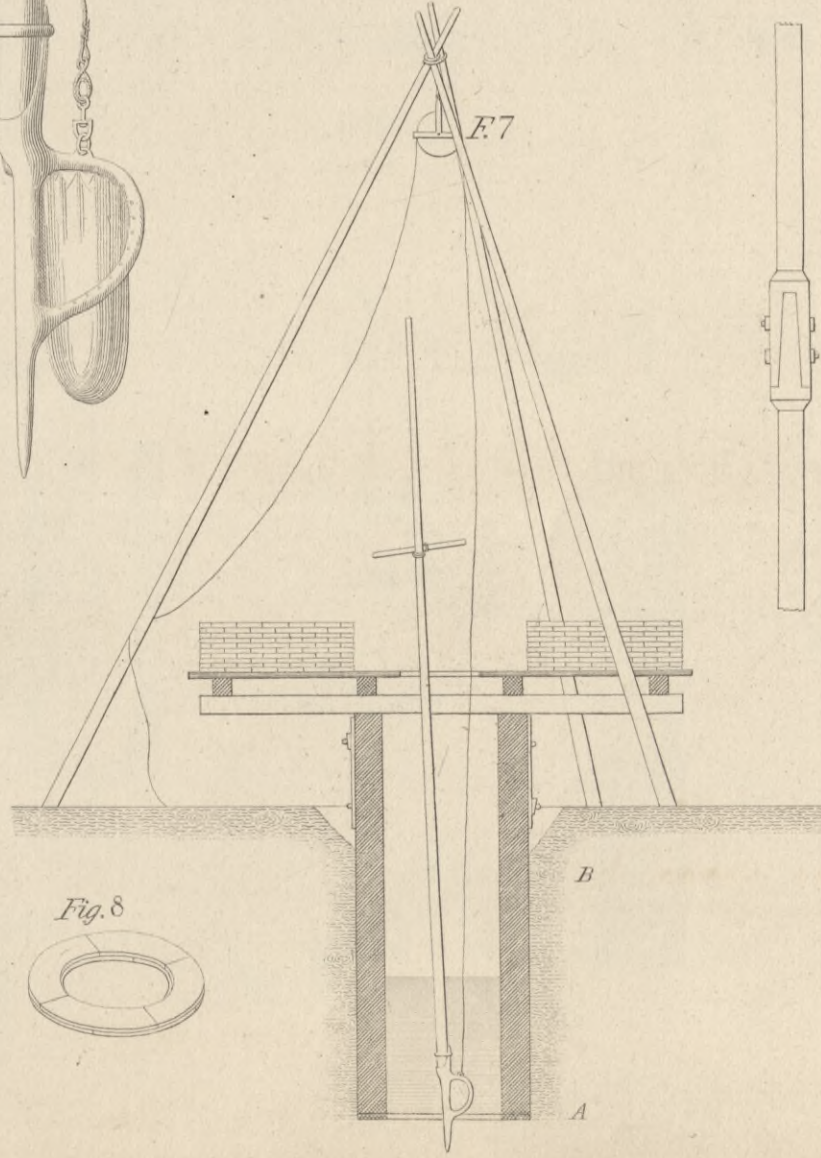
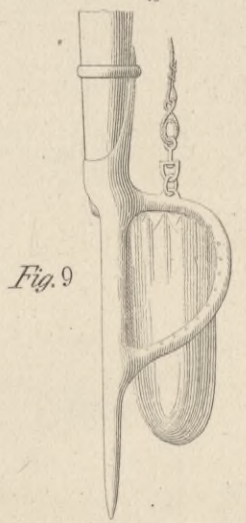

10 5 0 5 10 Fuss.

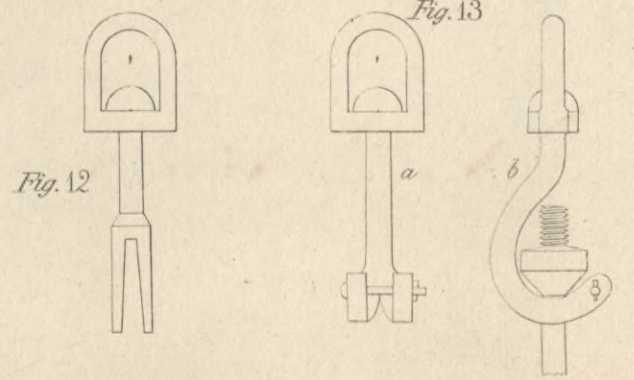

12 9 6 3 0 12 Zoll. zu Fig. 11, 12, 13 und 14.

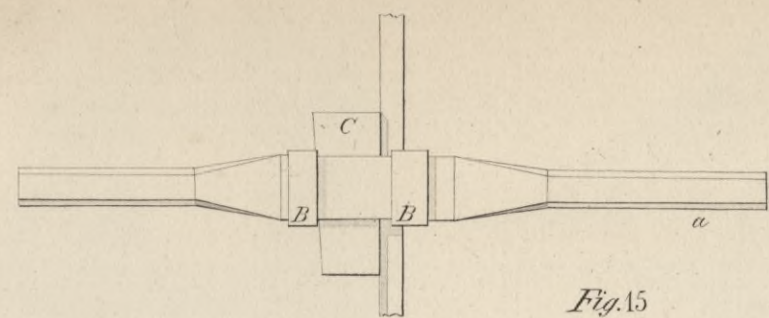
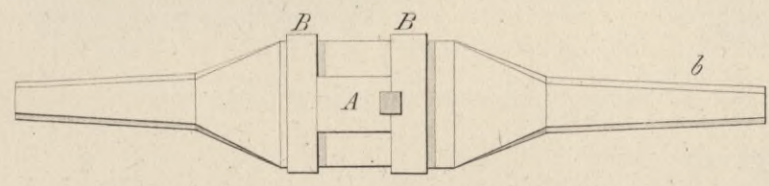

Fig. 15



b

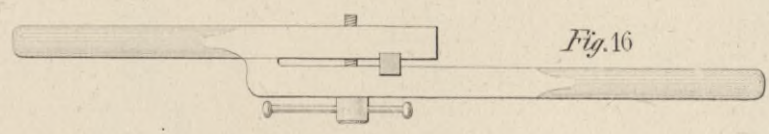

Fig. 16

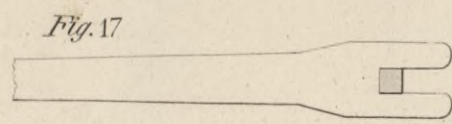

Fig. 17



Fig. 22

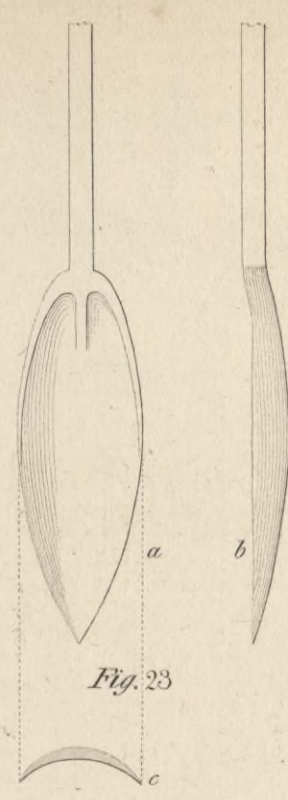

Fig. 23



Fig. 24

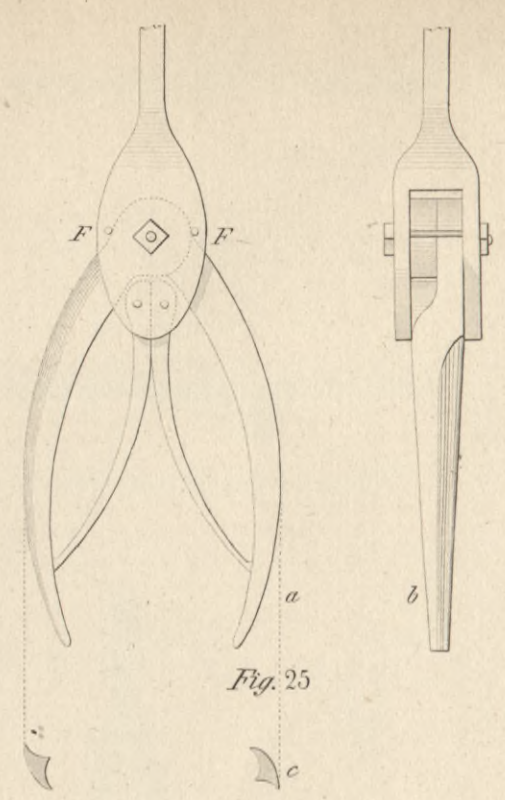

Fig. 25

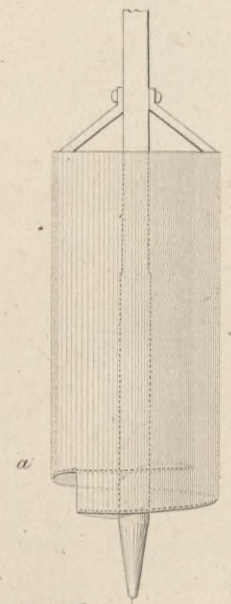

Fig. 18

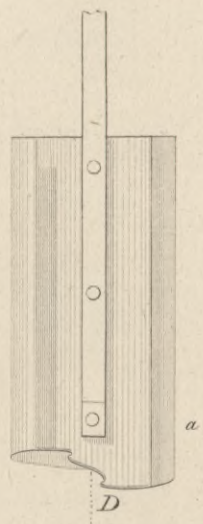
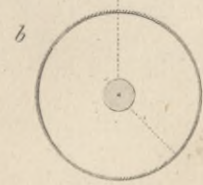

Fig. 19

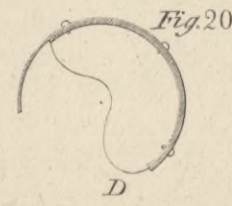
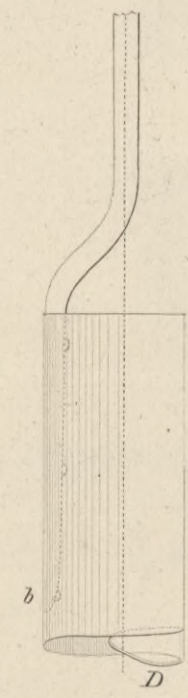
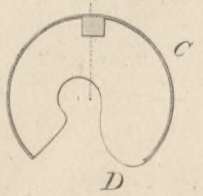

Fig. 20

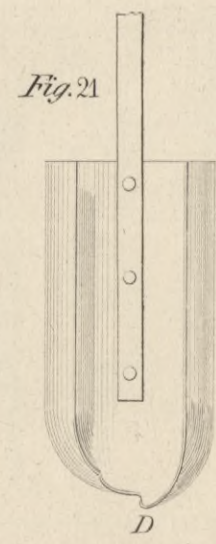

Fig. 21

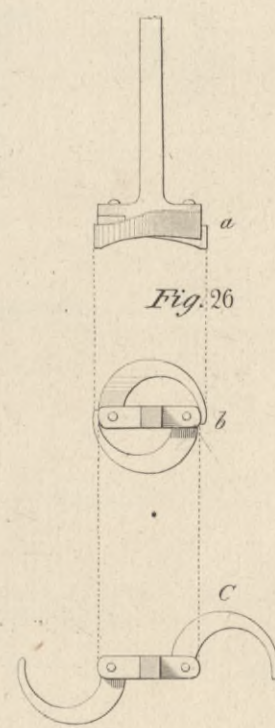

Fig. 26

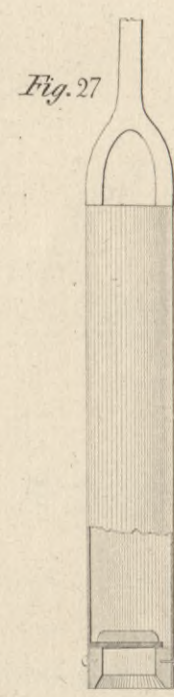

Fig. 27

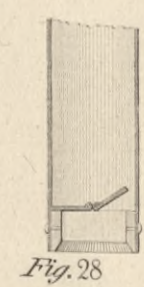

Fig. 28

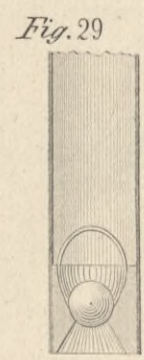

Fig. 29

Fig. 30

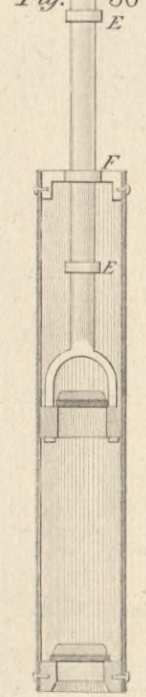
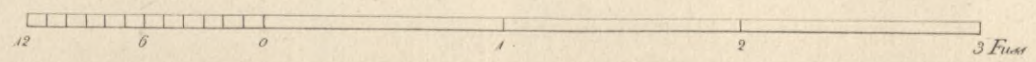
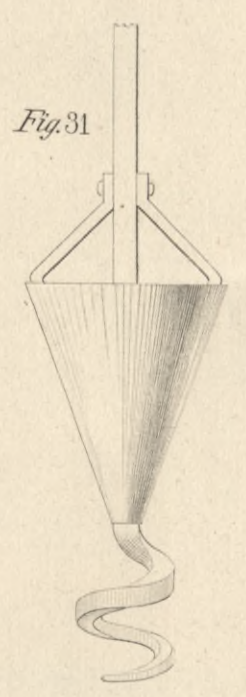
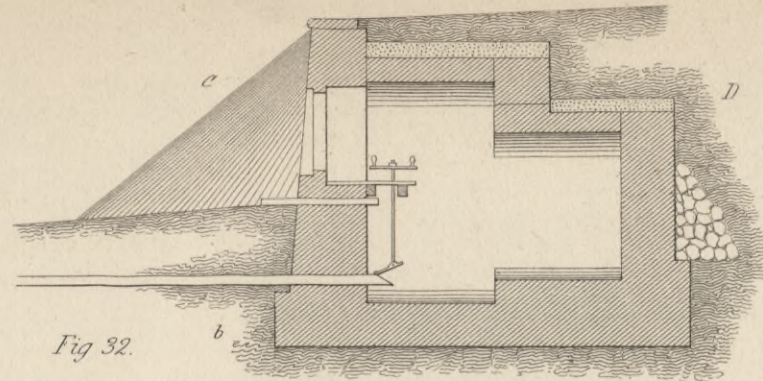
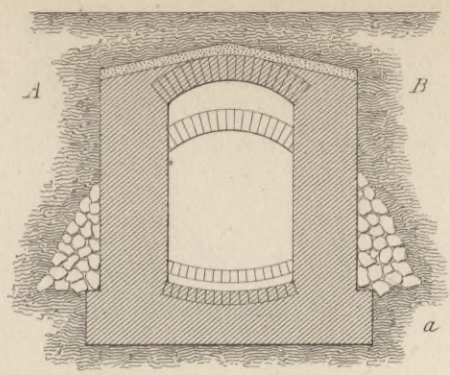
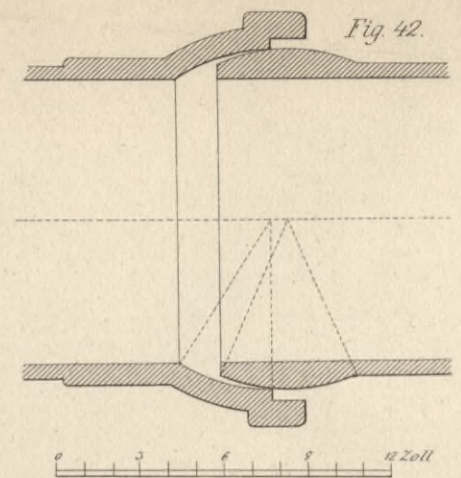
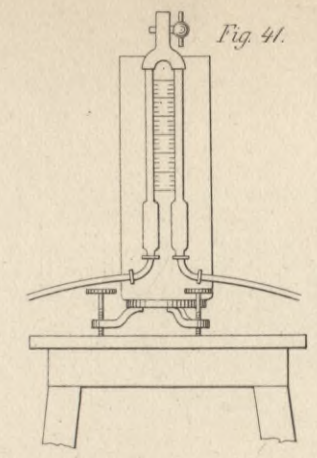
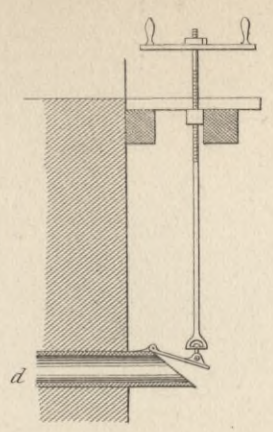

Fig. 31





10 Fuss



12 Zoll

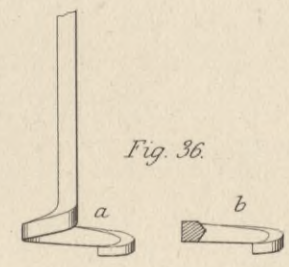
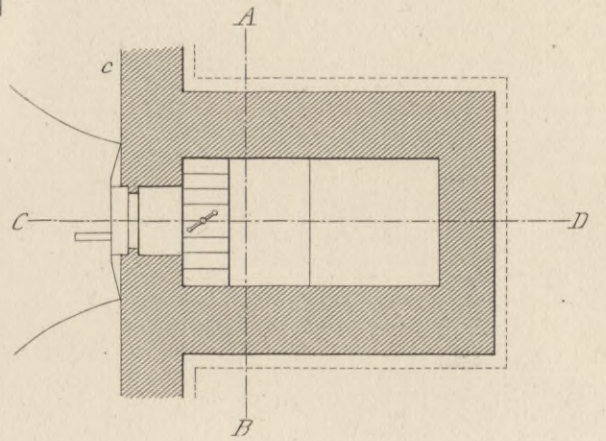
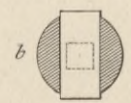
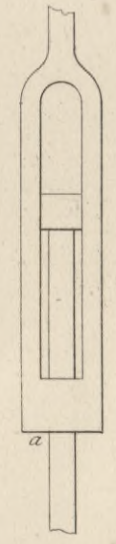
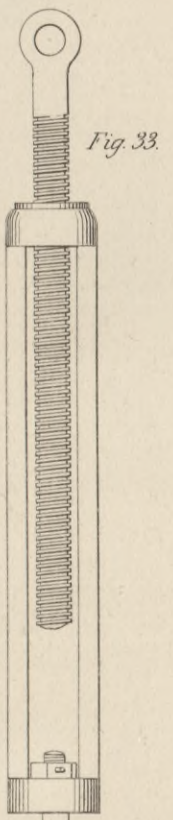

Fig. 36.

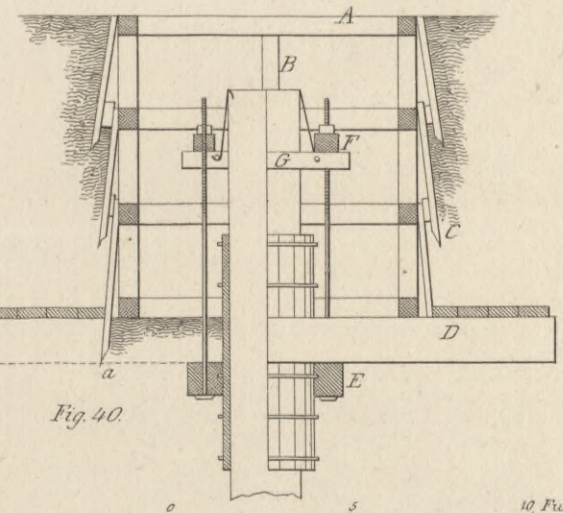

Fig. 40.

10 Fuss

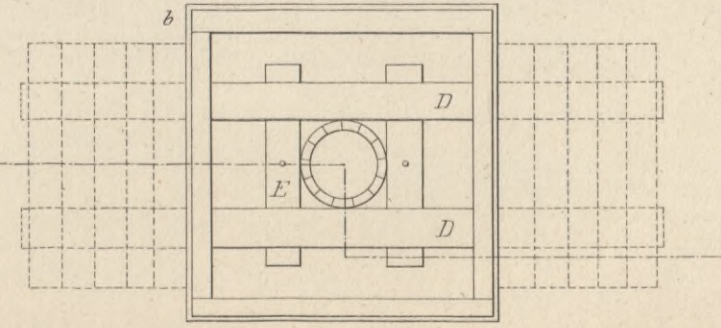

Fig. 35.

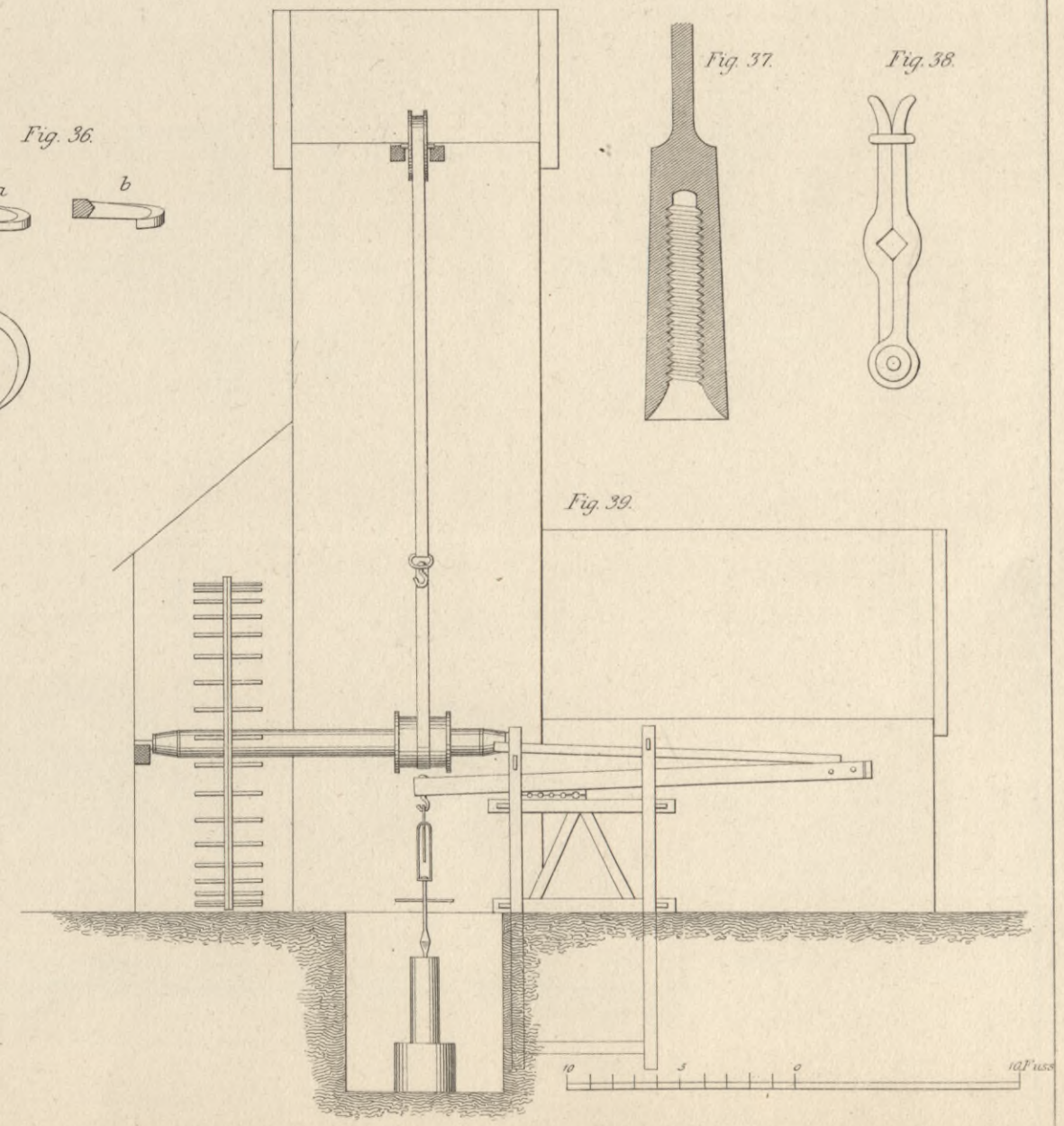

Fig. 39.

10 Fuss

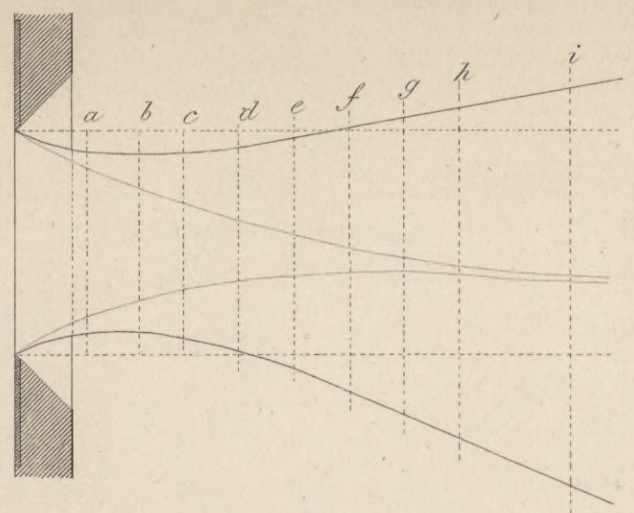

Fig. 69

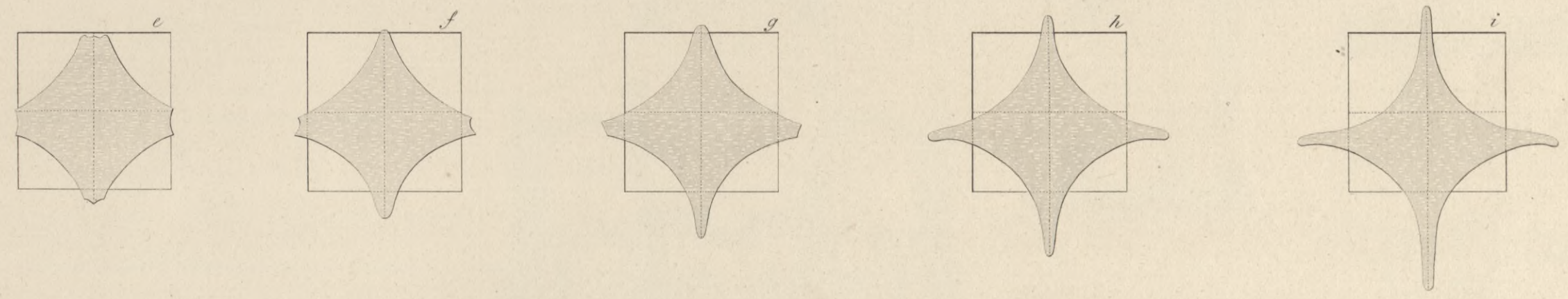
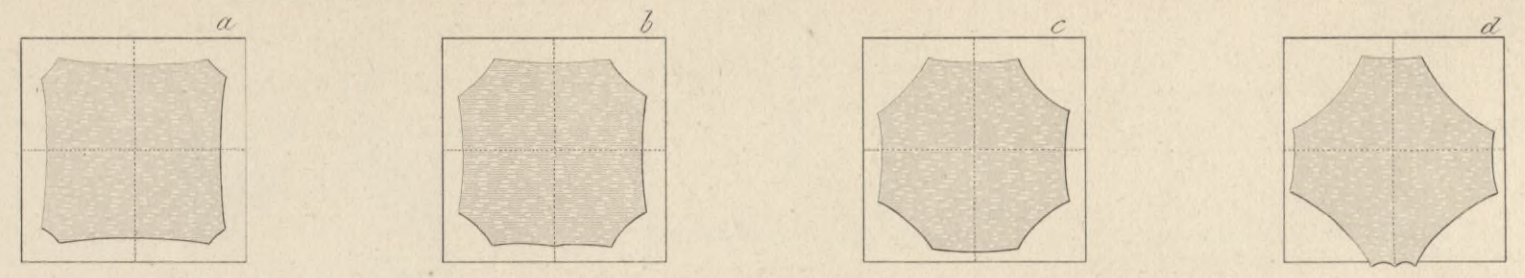
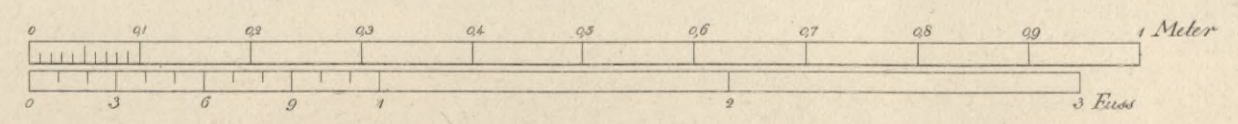
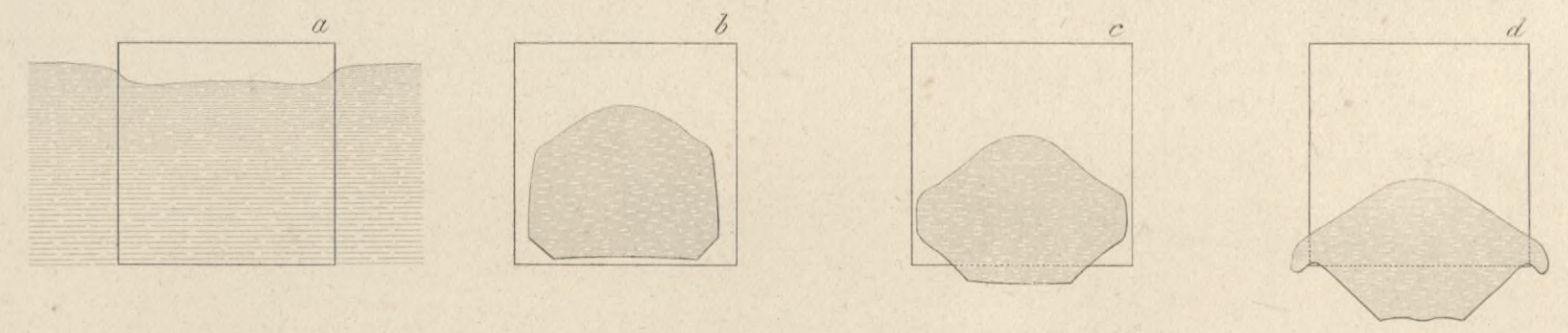
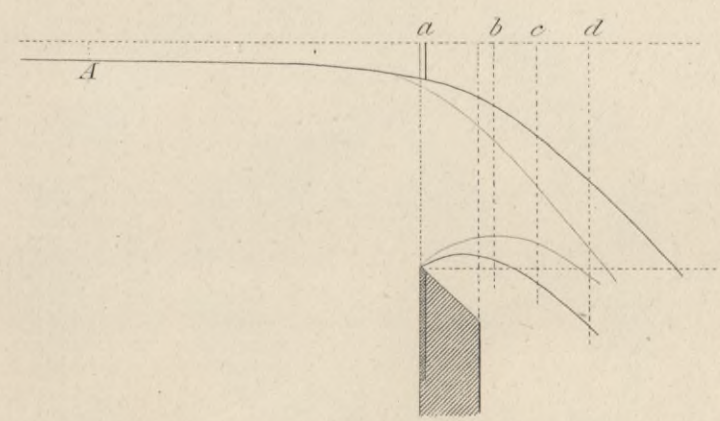
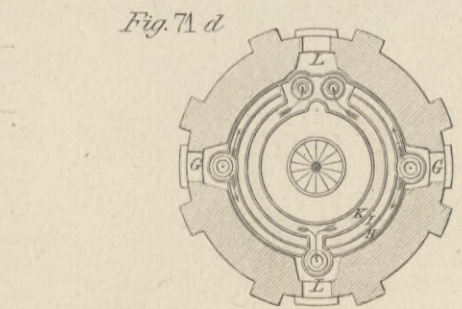
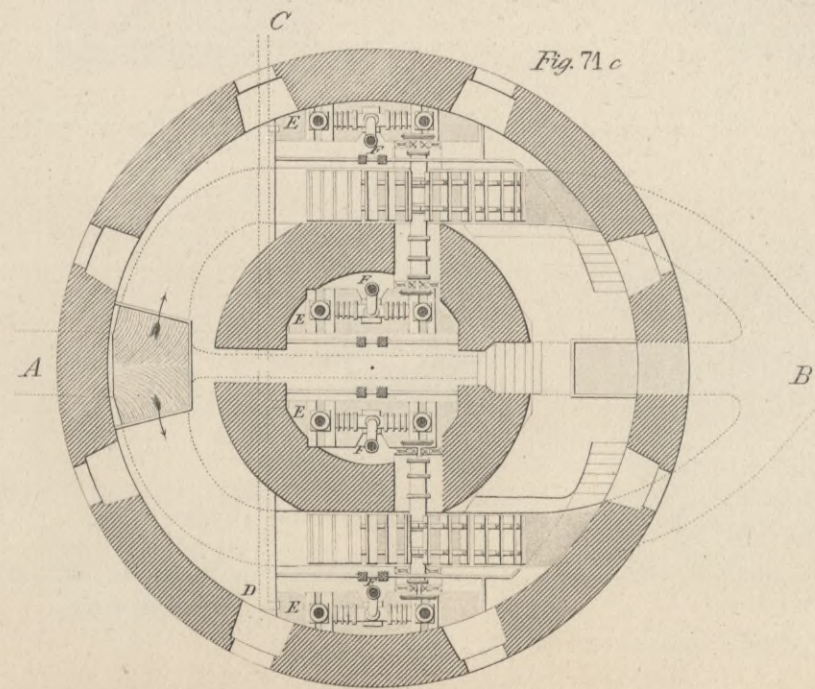
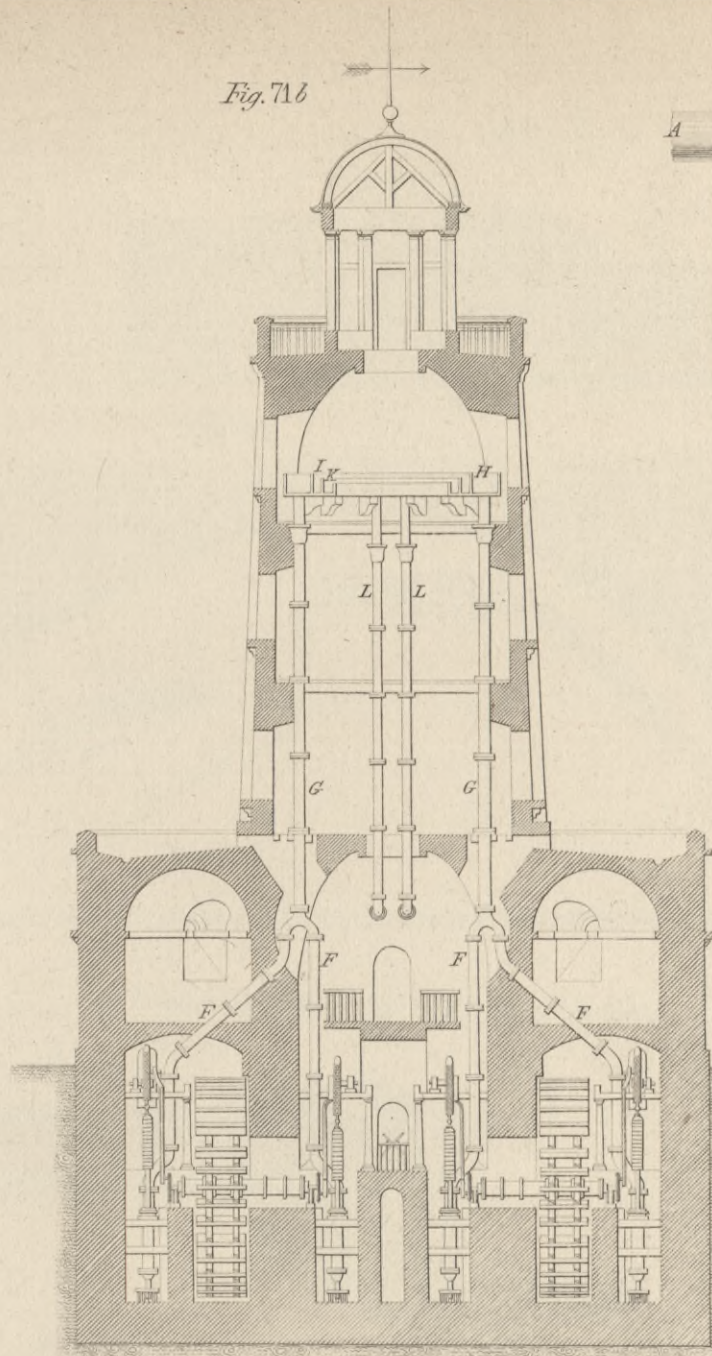
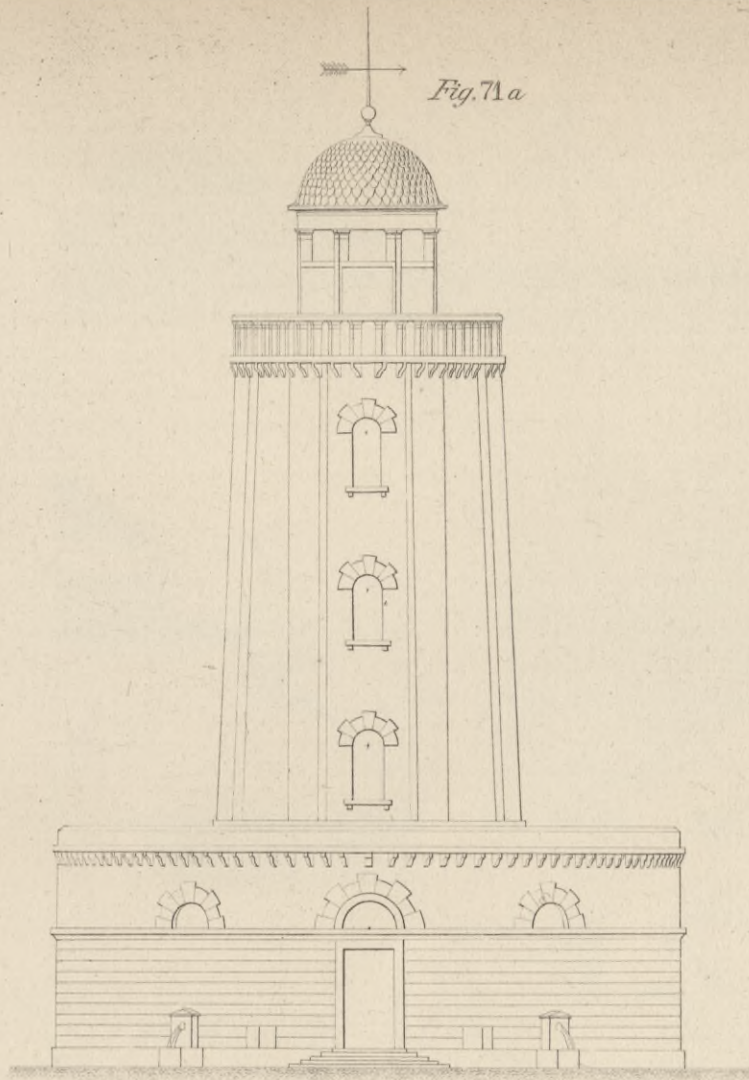
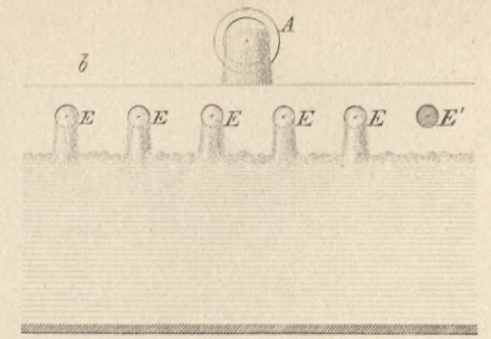
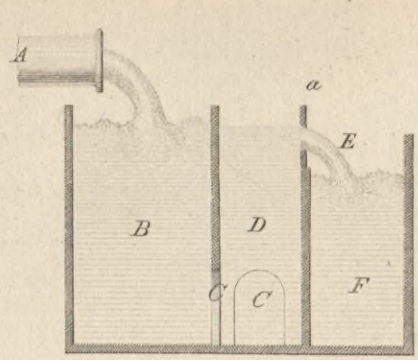

Fig. 70





zu Fig. 71
10 5 0 10 20 30 40 Fuß



zu Fig. 73
1 2 3 4 5 Fuß

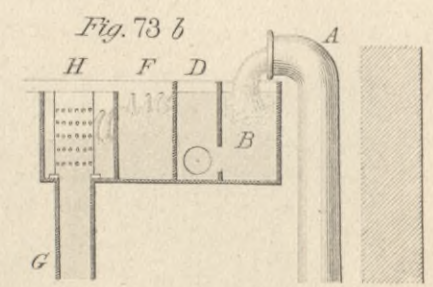
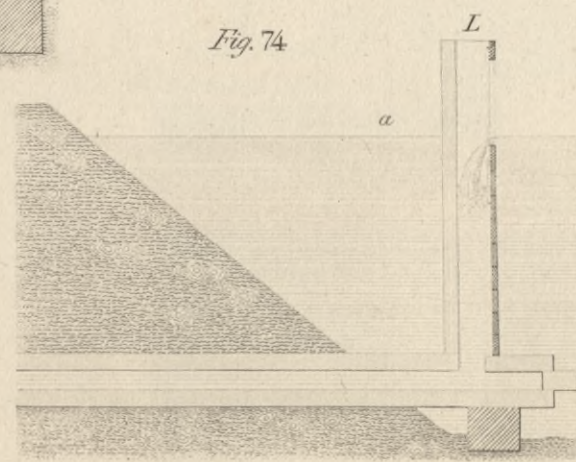
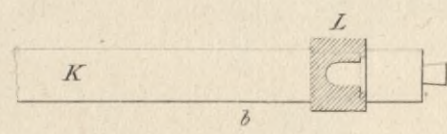
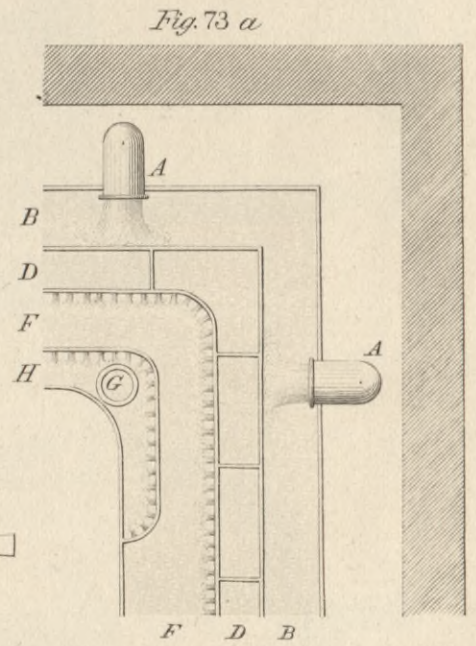
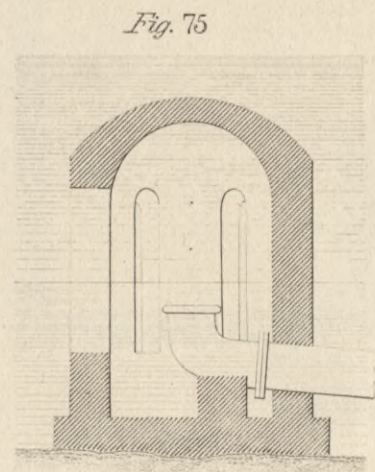

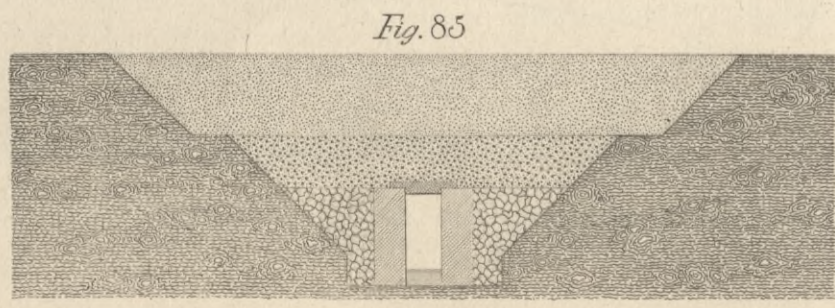
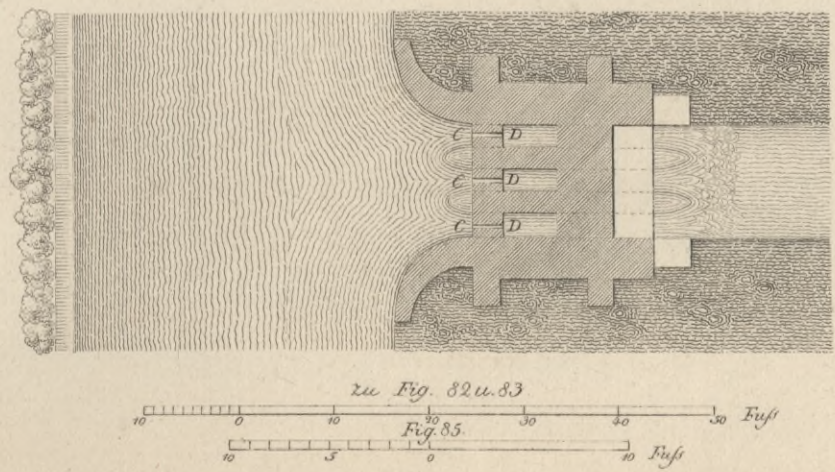
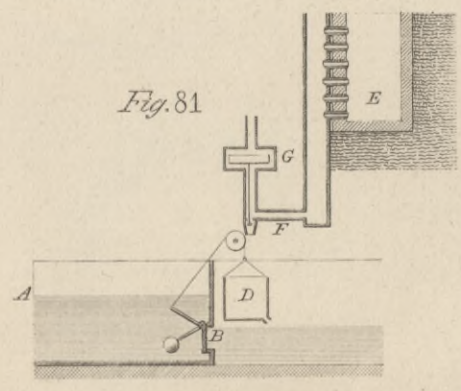
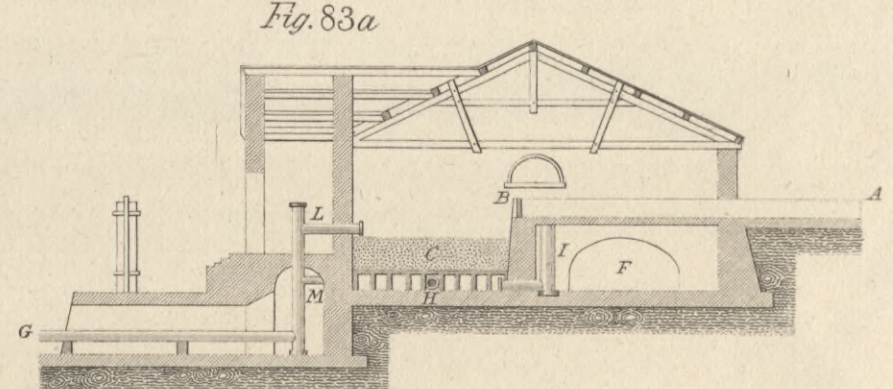
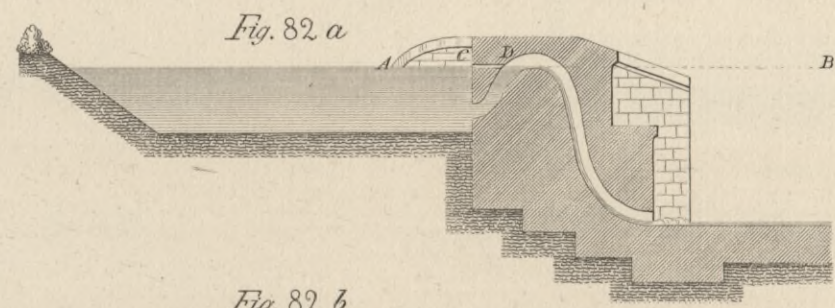
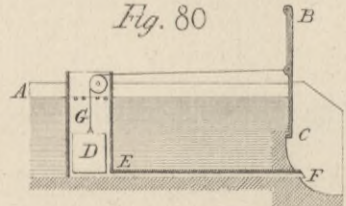
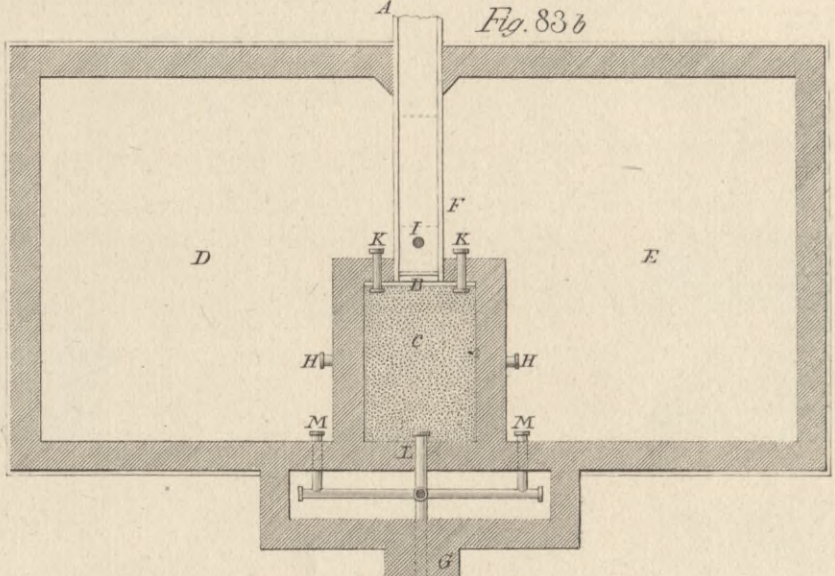
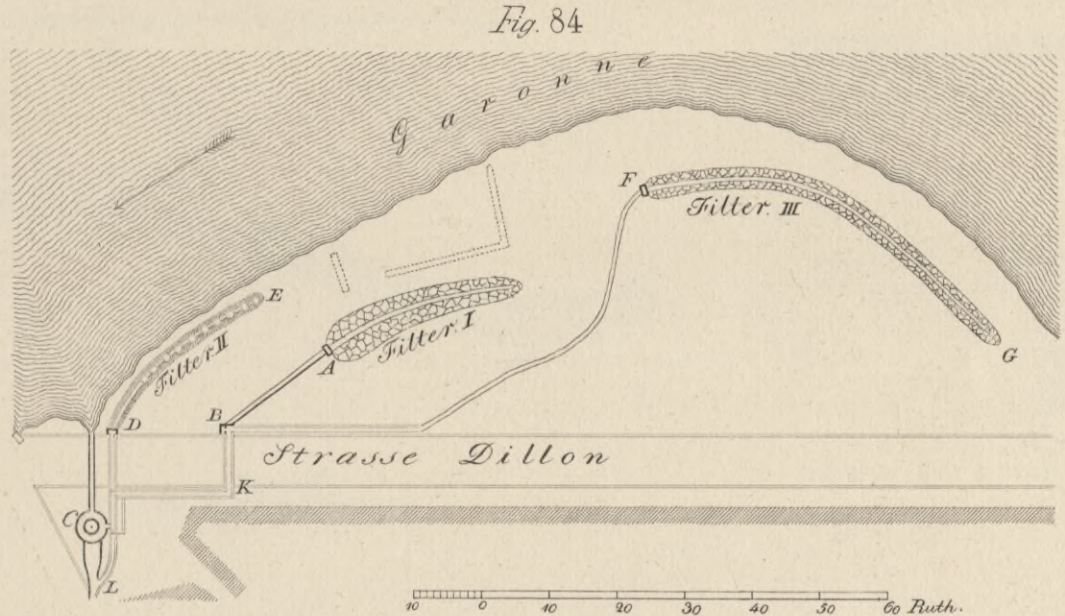
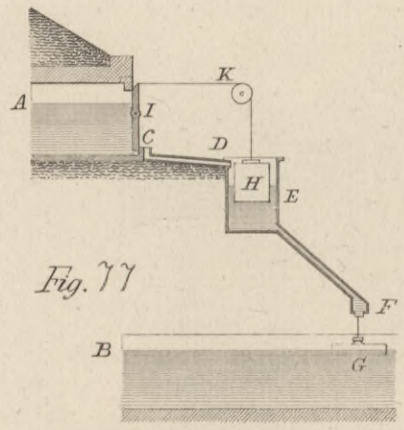
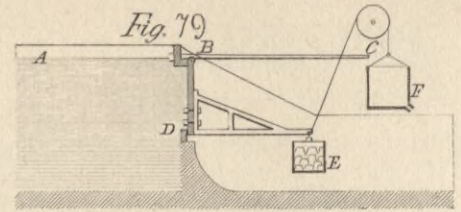
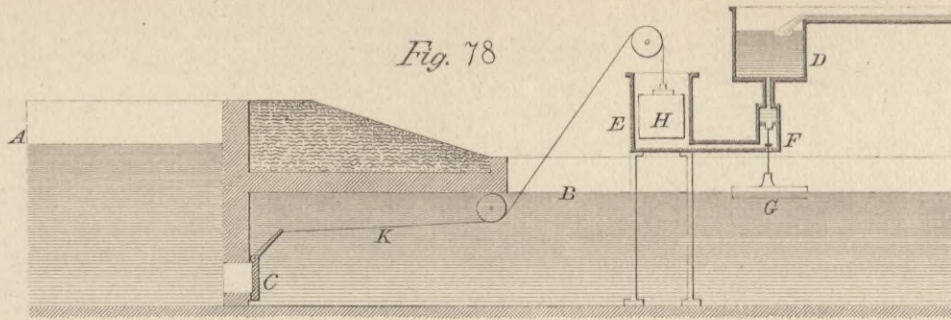
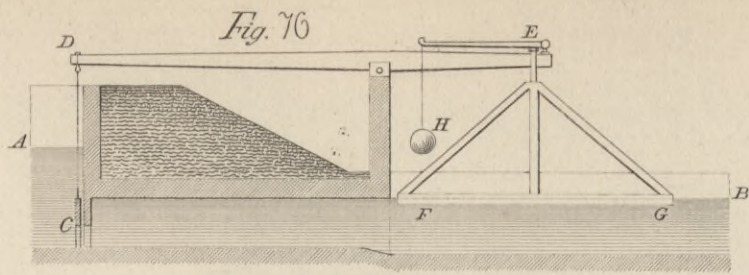

Fig. 86.

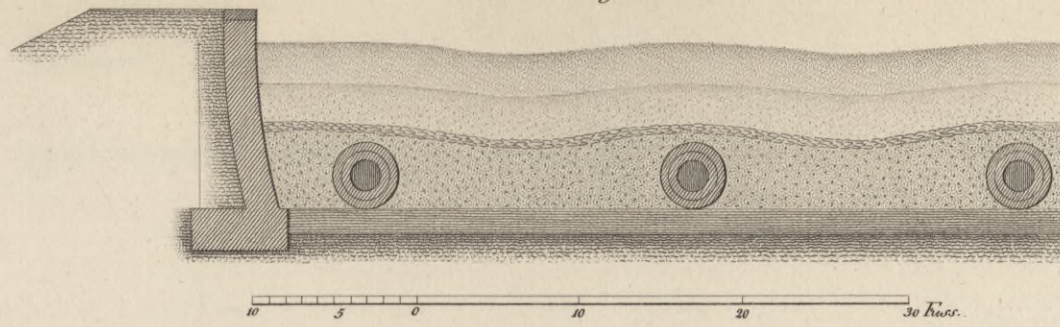

Fig. 87.

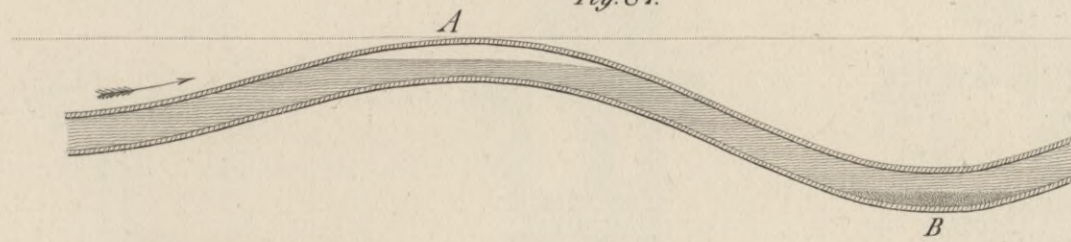

Fig. 96.

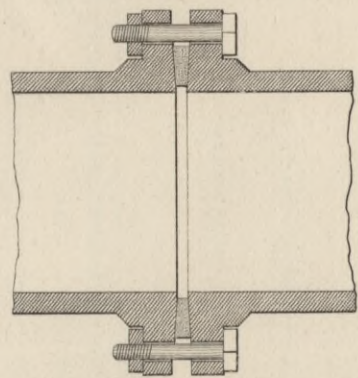

Fig. 97.

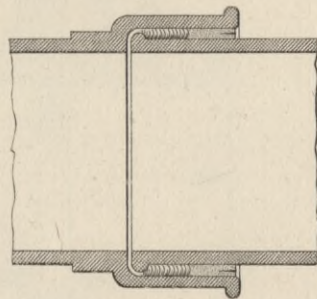

Fig. 98.

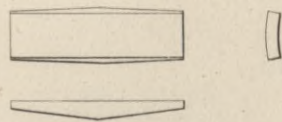

Fig. 100.

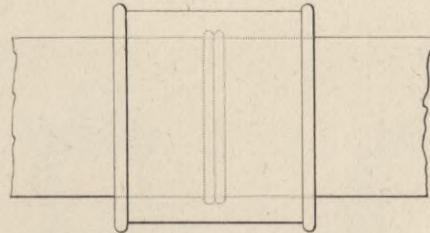
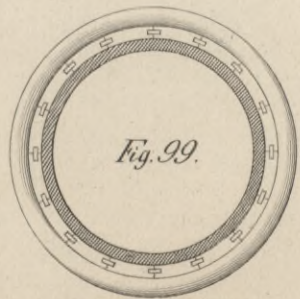
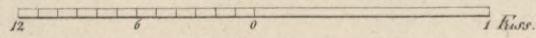

Fig. 99.



zu Fig. 91-92 u. 96-100.



zu Fig. 88-90 u. 93-95.

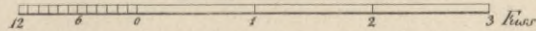

Fig. 90.

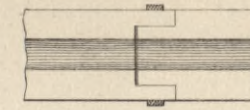
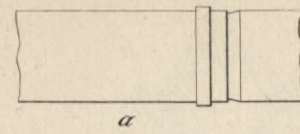

Fig. 88.

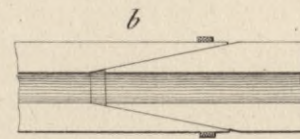

Fig. 89.

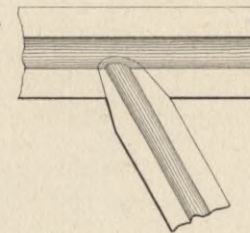

Fig. 93a.

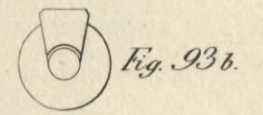
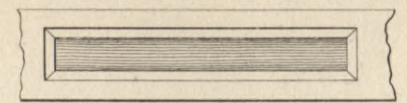

Fig. 93c.

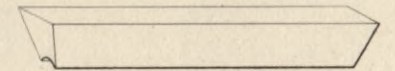

Fig. 94.

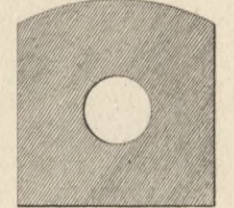

Fig. 91.

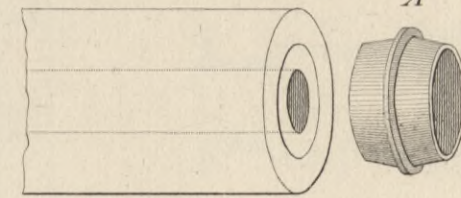

Fig. 92.

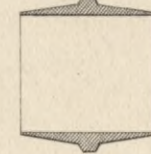

Fig. 95a.

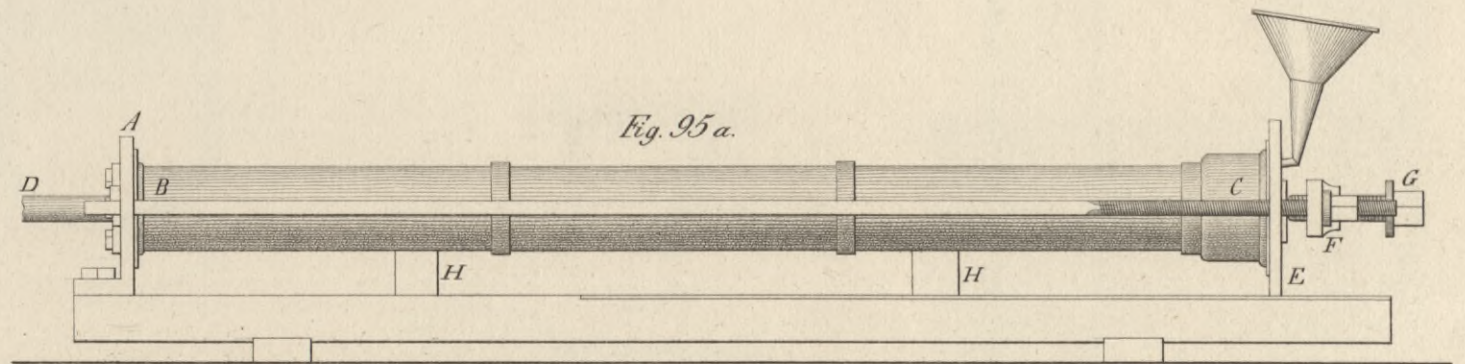

Fig. 95b.

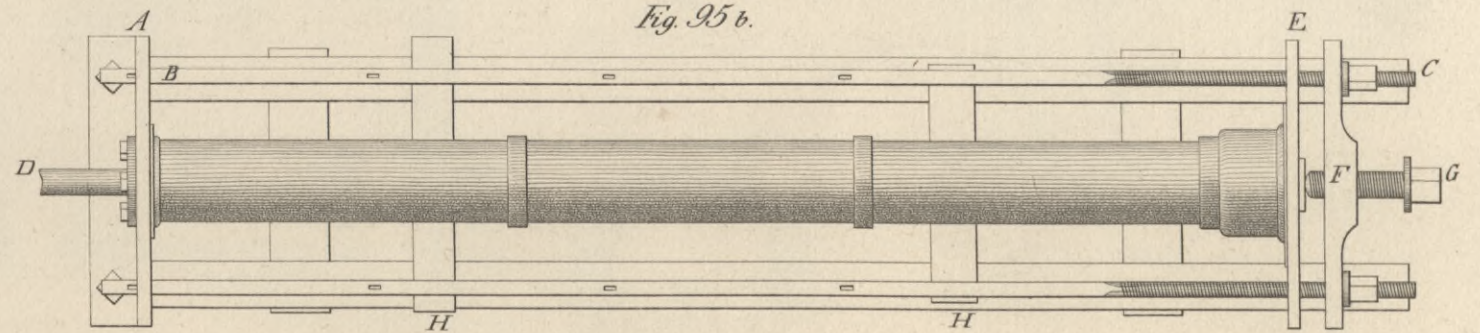

Fig. 101.

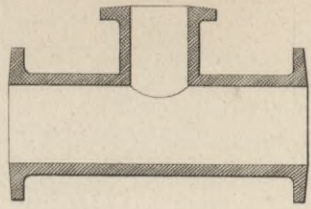

Fig. 102.

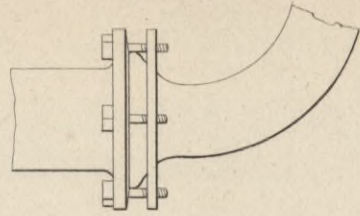

Fig. 103.

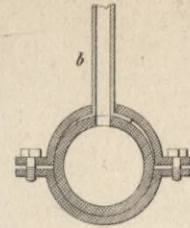
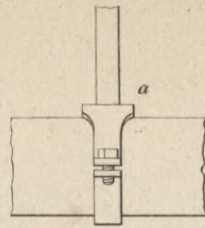

Fig. 104.

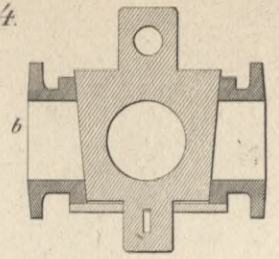
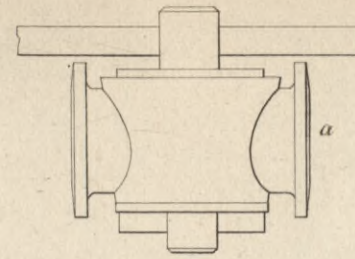

Fig. 105.

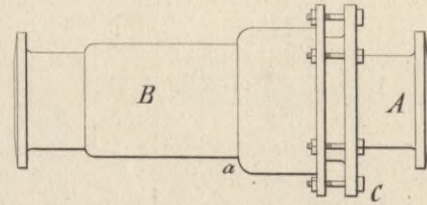
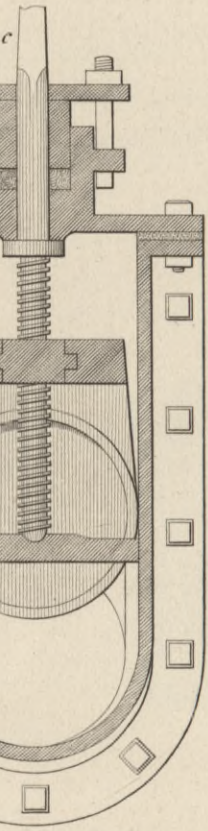
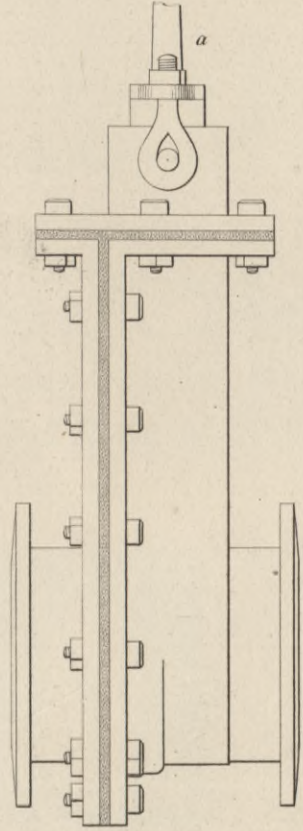
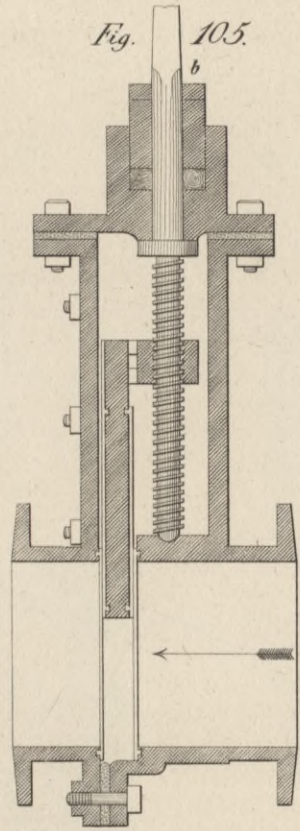

Fig. 109.

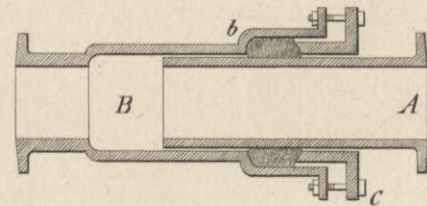

Fig. 107.

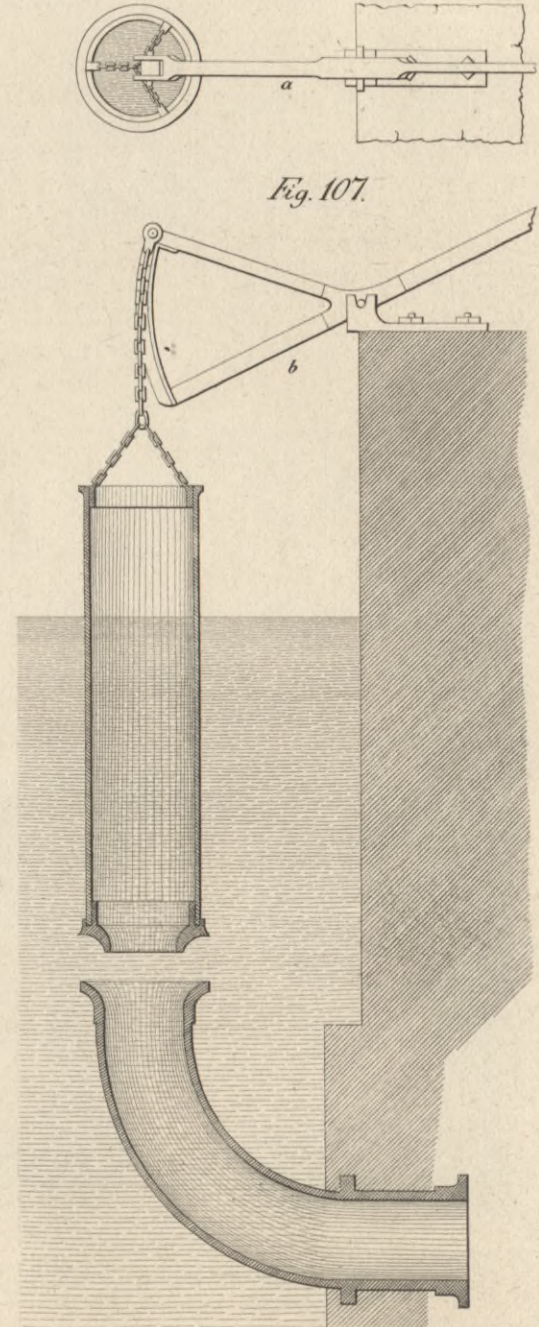

Fig. 108.

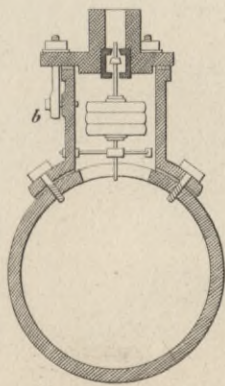
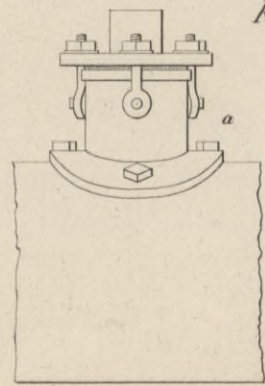

Fig. 110.

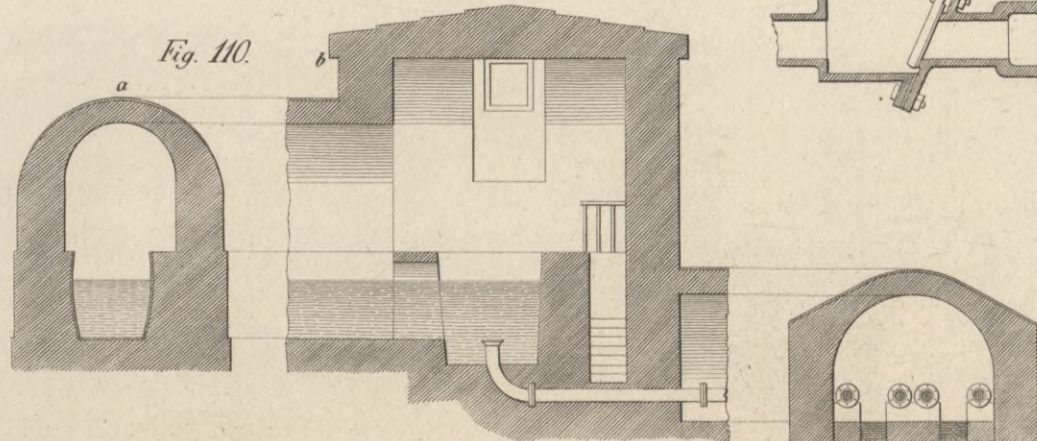

Fig. 110. c.

20 Fuss.



Fig. 111.

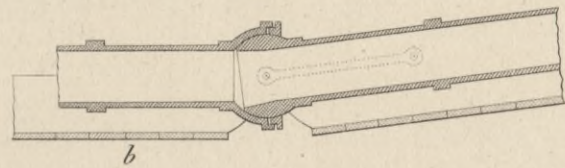
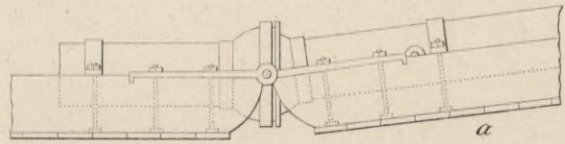

Fig. 112.

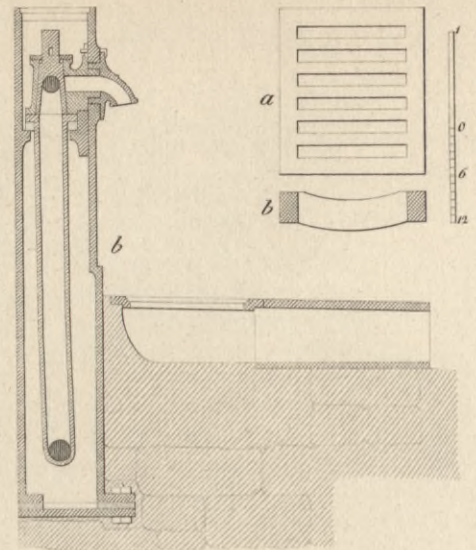
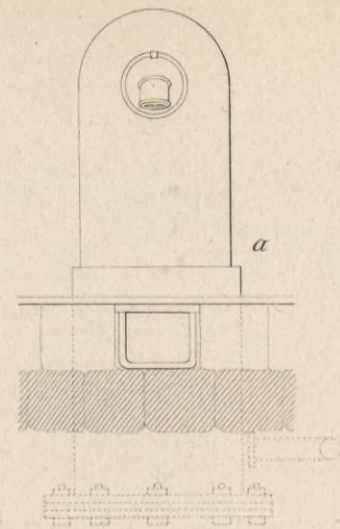
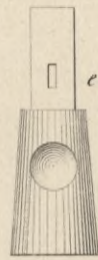
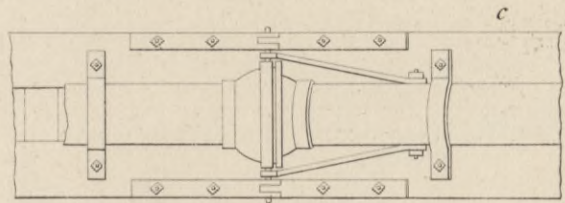

Fig. 116.

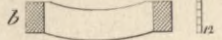
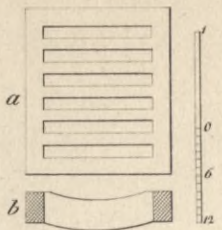

Fig. 113.

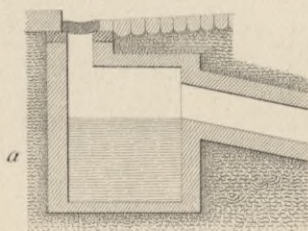

Fig. 115.

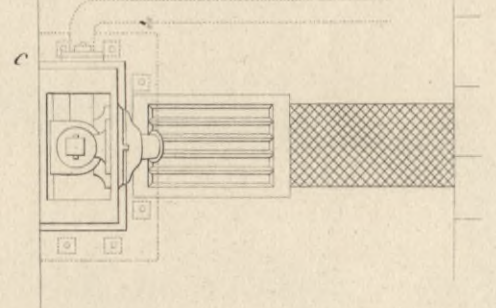
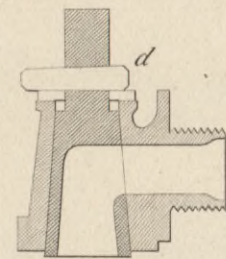
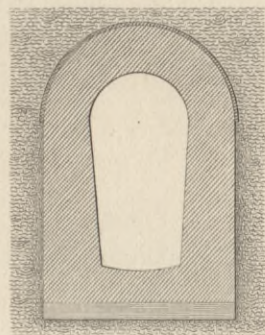

Fig. 114.

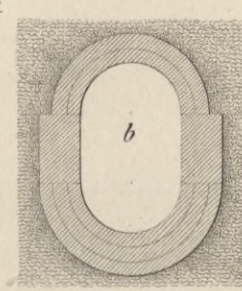

Fig. 117.

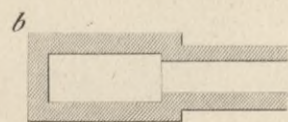

Fig. 120.

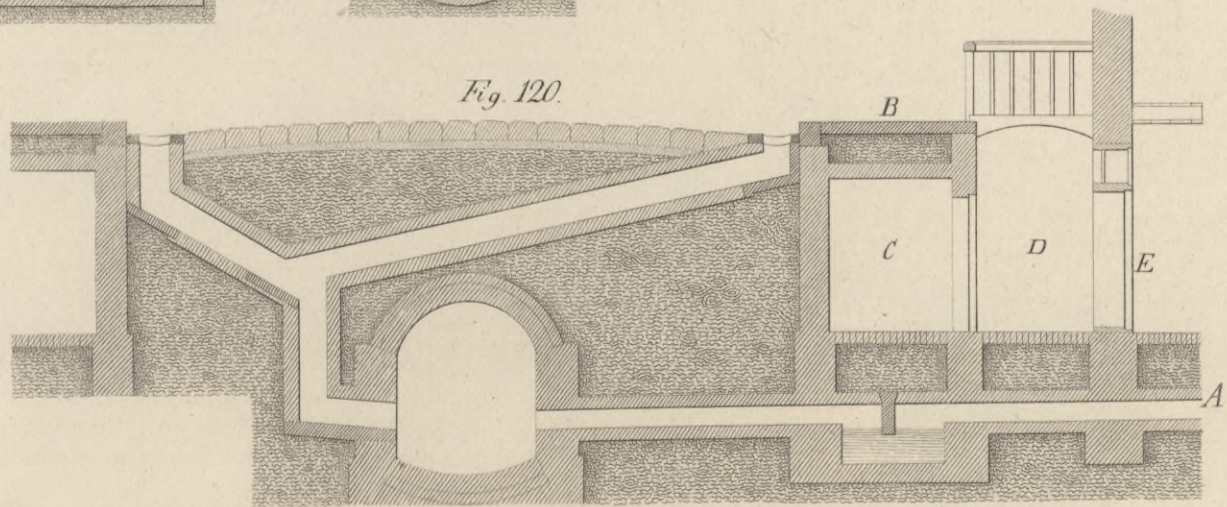

Fig. 118.

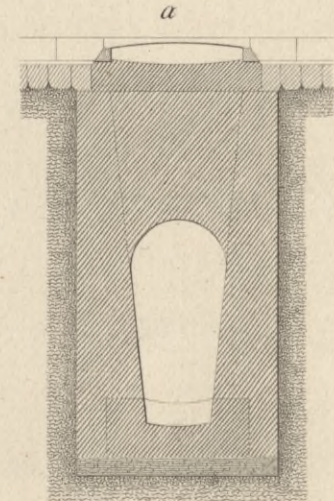
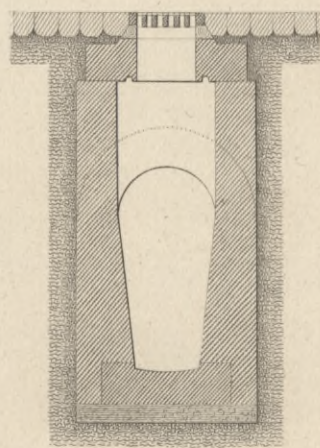
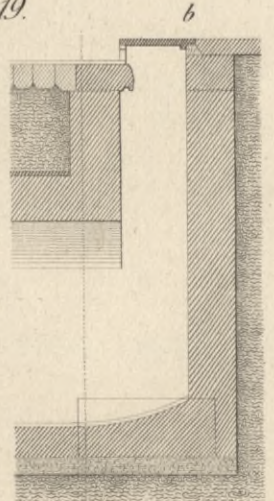







Fig. 119.



10 5 0 10 20 Fufs zu Fig. 120.

10 5 0 1 2 3 Fufs zu Fig. 113 a, b, u. c.

10 5 0 10 Fufs zu Fig. 114, 115, 117-119.

-  Haupt-Abzugs Canal.
-  Flüsse u. Gräben.
-  Wege.
-  Dämme.
-  Colmations-Bassins.
-  Brücken-Canäle.

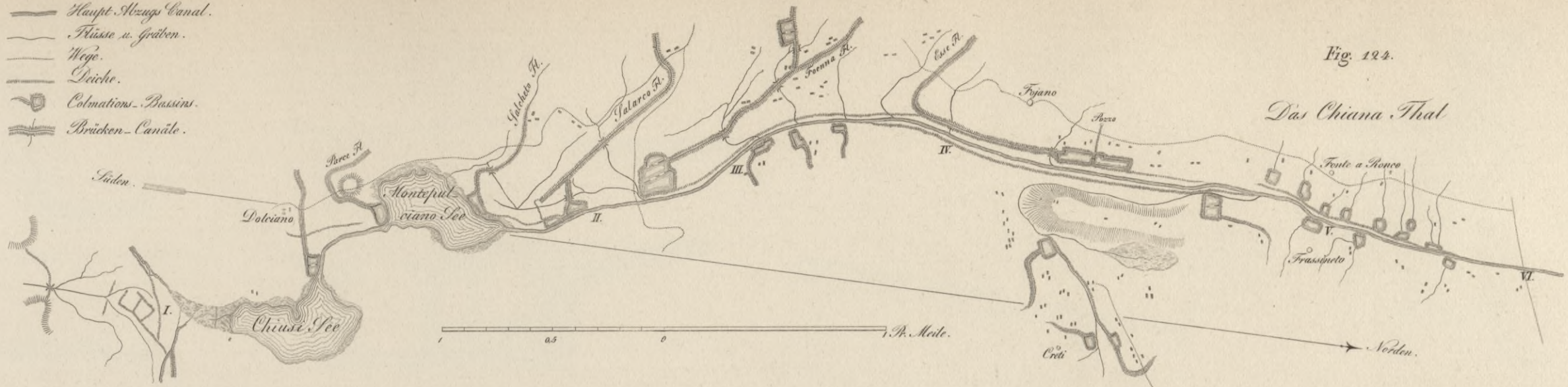

Fig. 124.

Das Chiana Thal

Fig. 125.

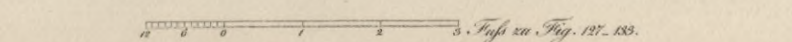
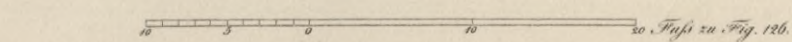
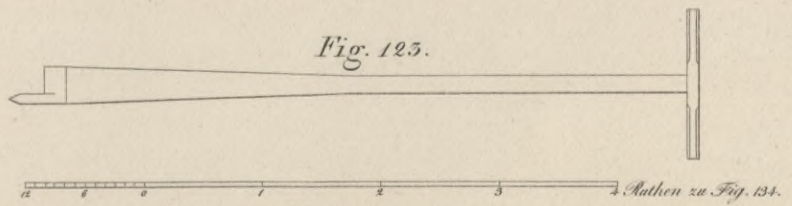
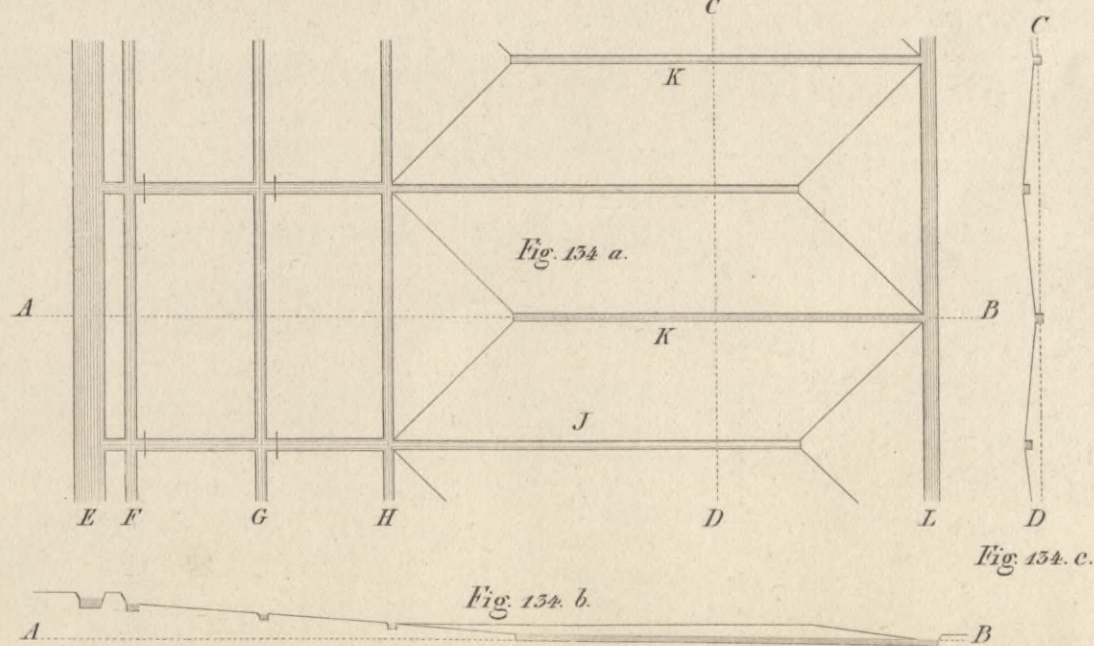
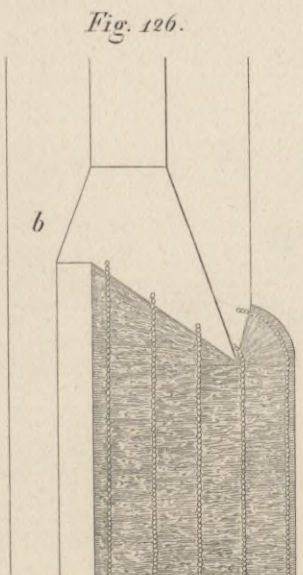
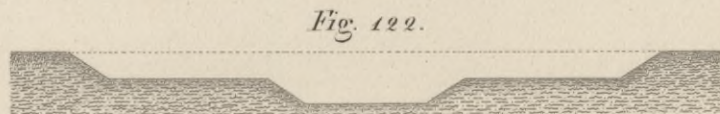
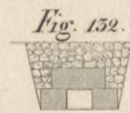
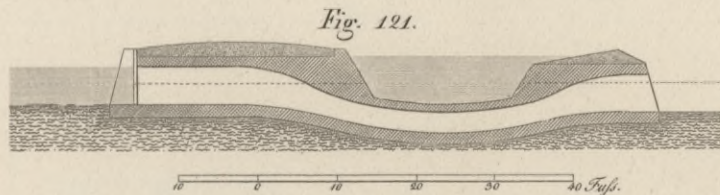
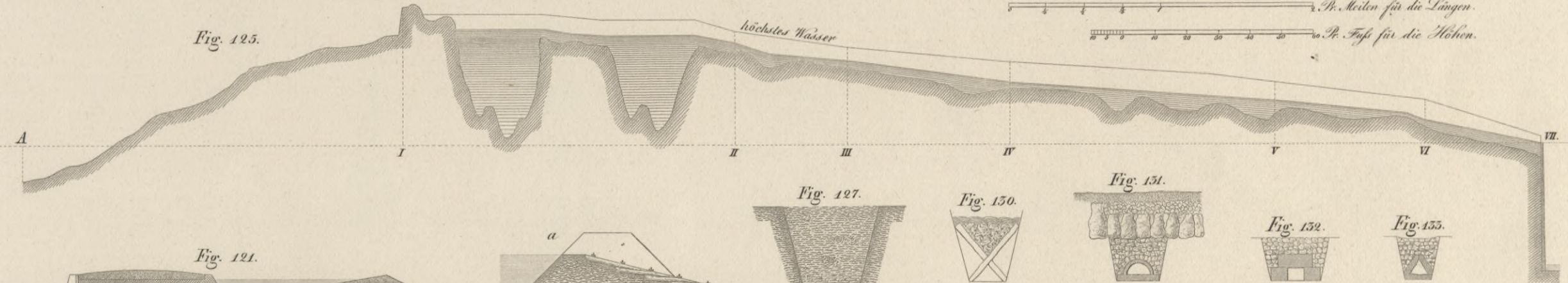
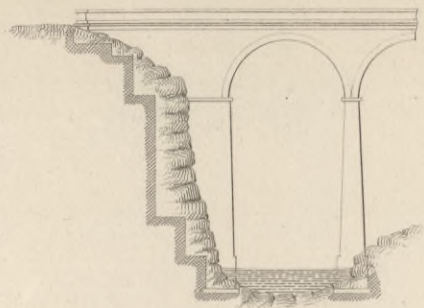

Fig. 135.



0 5 10 20 30 40 50 60 70 80 Fuss.



Fig. 136.

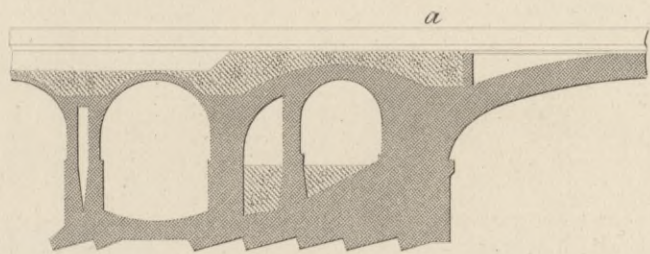

Fig. 143.

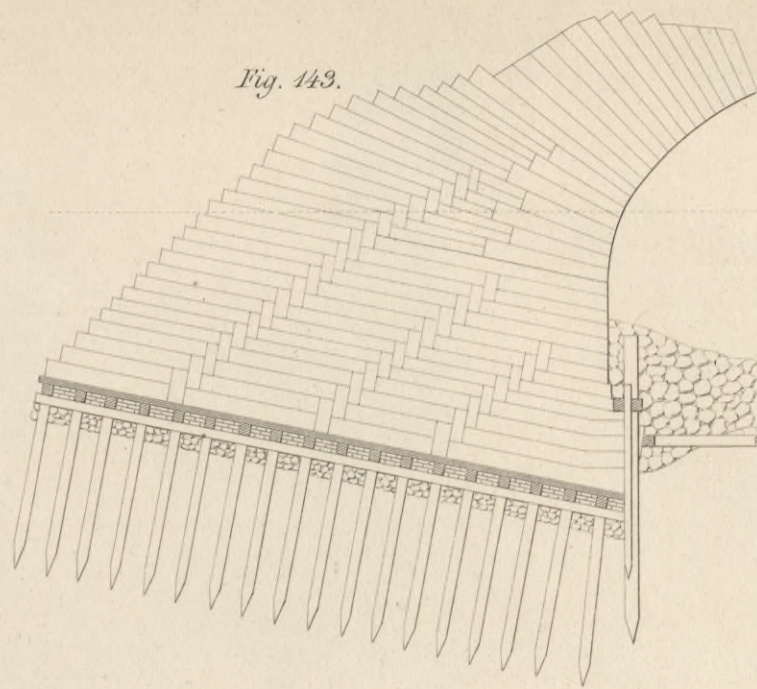
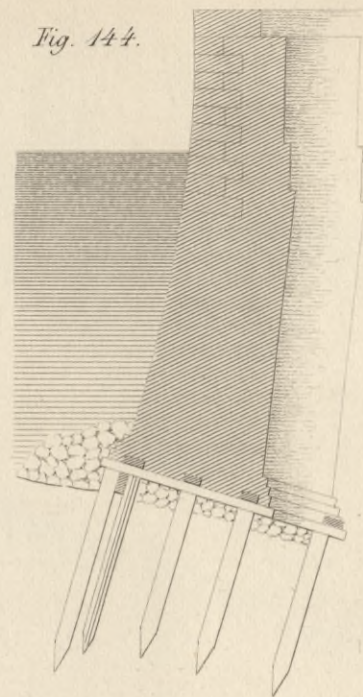

Fig. 144.



0 5 10 15 20 25 30 Fuss.

Fig. 137.

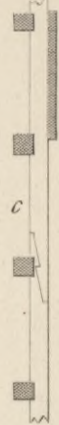
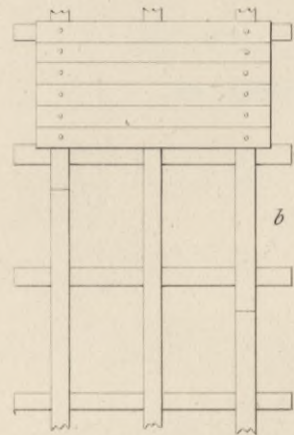
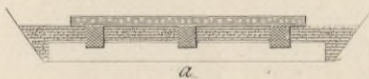

Fig. 141.

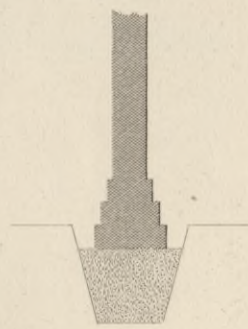

Fig. 142.

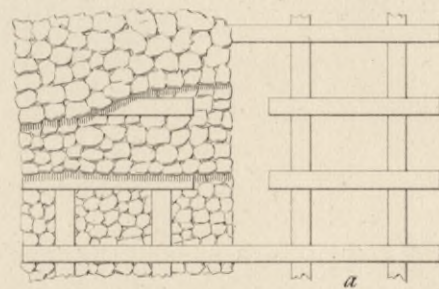
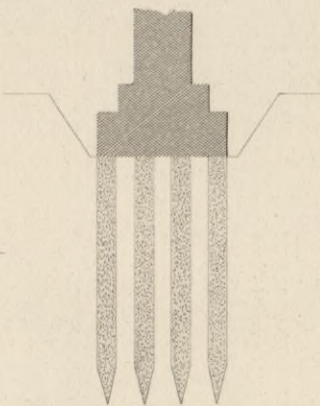

Fig. 140.

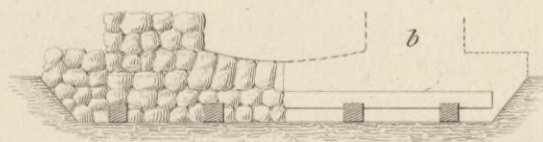

Fig. 145.



Fig. 138.

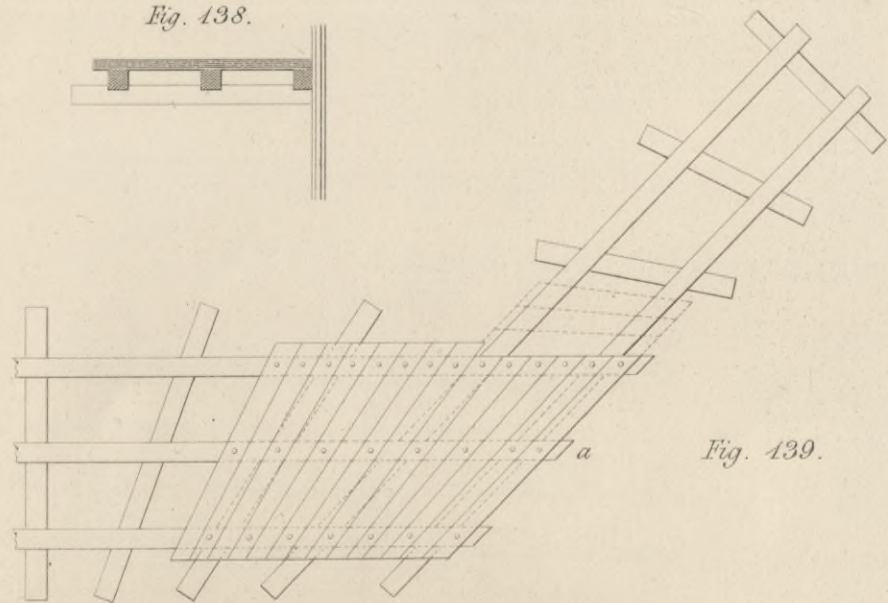
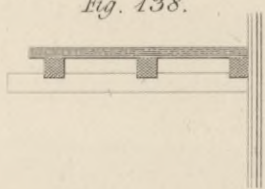

Fig. 139.

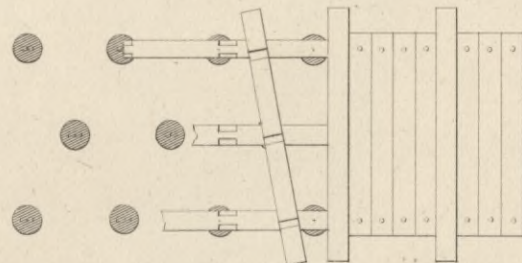
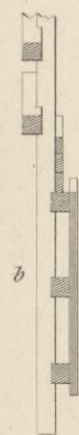

Fig. 146.

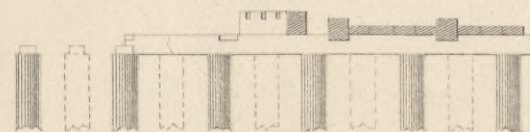
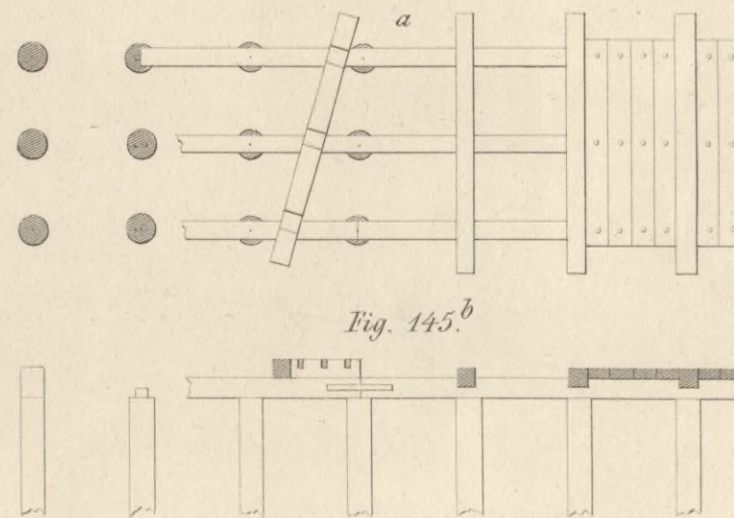

Fig. 145.^b



zu Fig. 137 bis 142. und 145 bis 146.

0 1 2 3 4 5 6 7 8 9 10 20 Fuss.

Fig. 147.

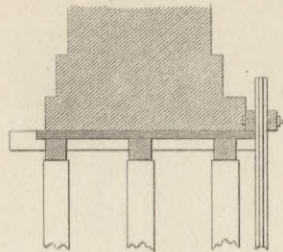

Fig. 148.

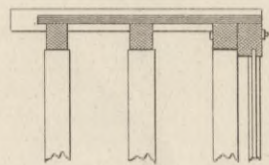

Fig. 149.

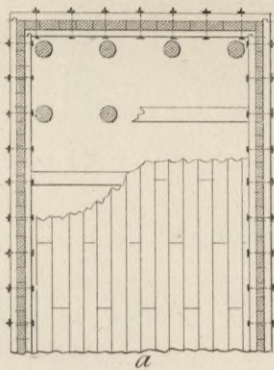
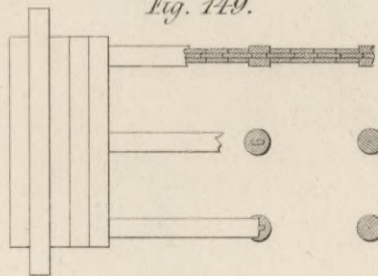

Fig. 151.

b

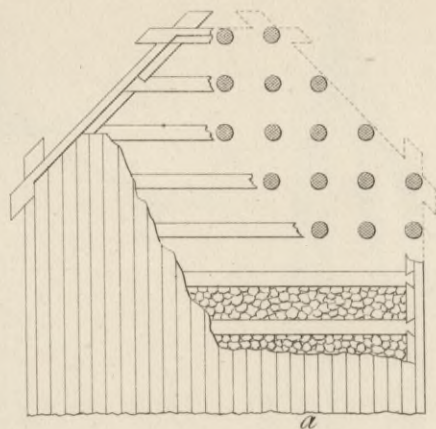
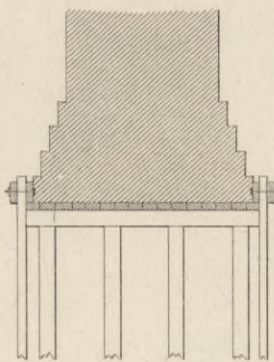

Fig. 153.

b

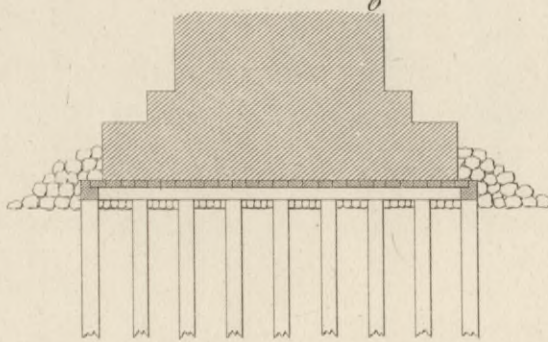

Fig. 155.

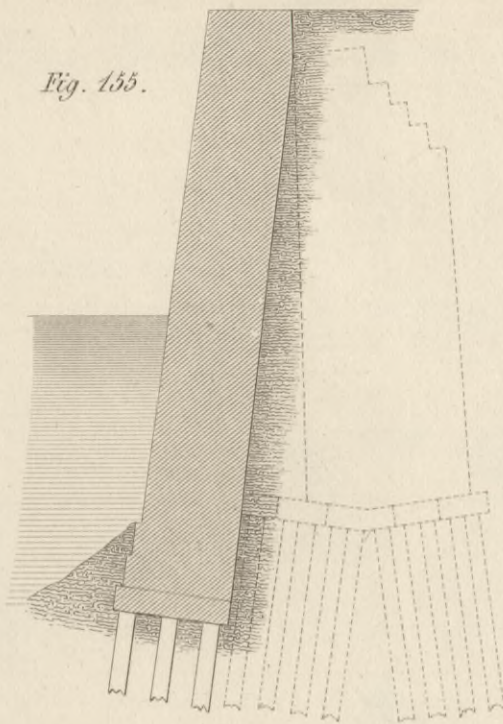

Fig. 157.

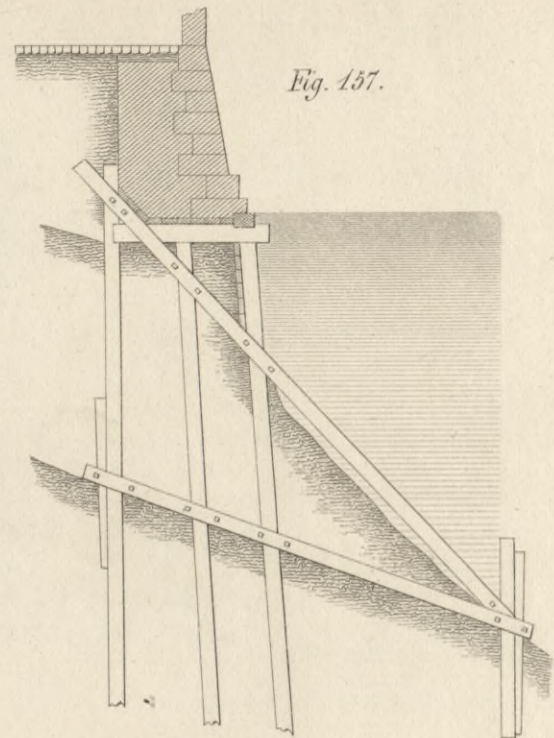

Fig. 150.

b

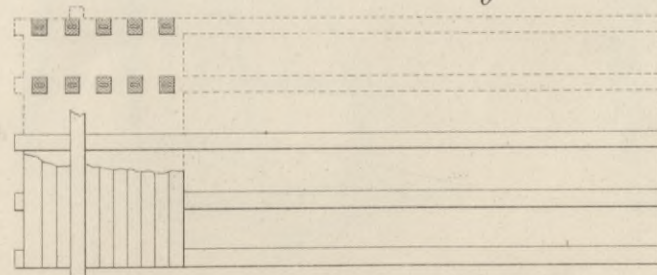
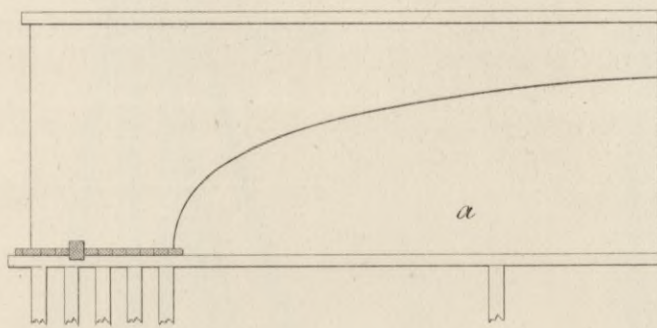

Fig. 152.

b

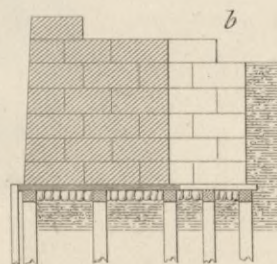
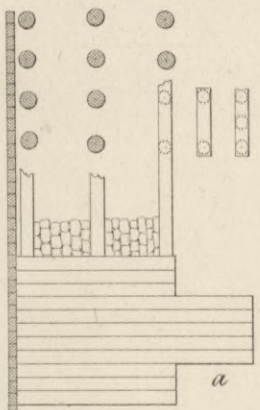

Fig. 154.

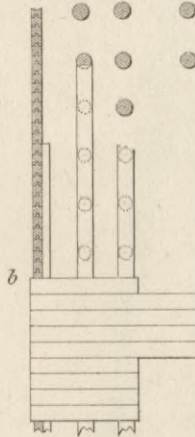
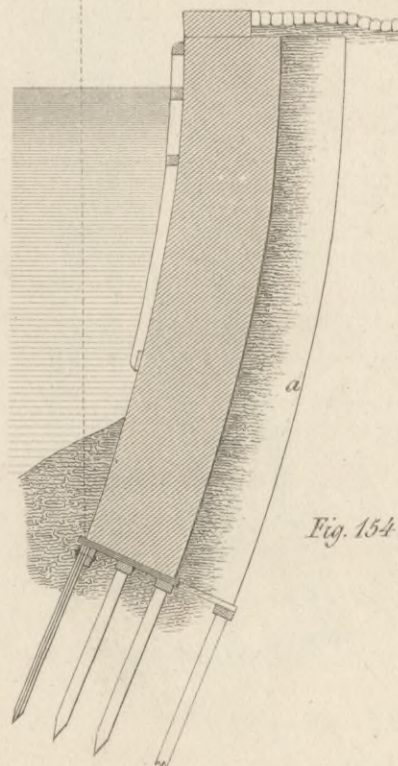
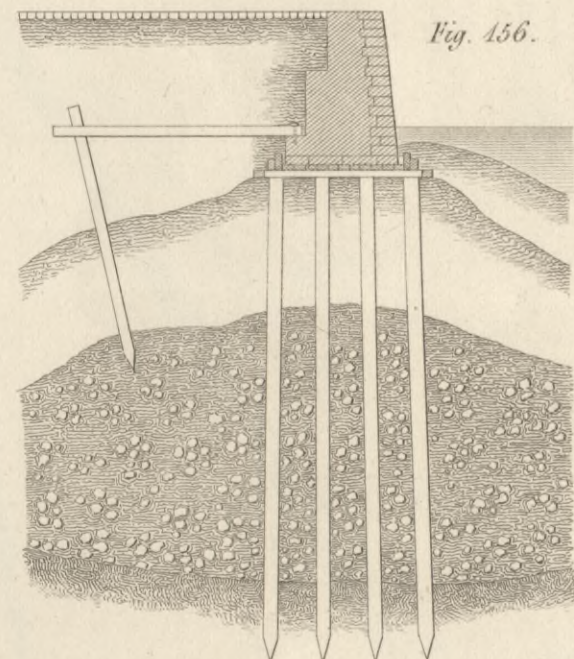
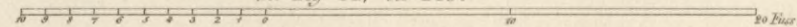

Fig. 156.



zu Fig. 147 bis 149.



zu Fig. 150 bis 155 und Fig. 157.

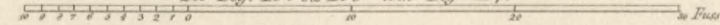

zu Fig. 156.

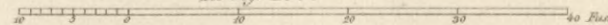

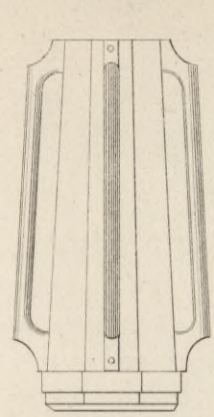

Fig. 158.

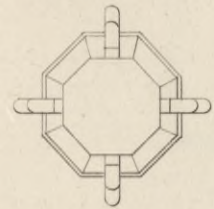

Fig. 161.

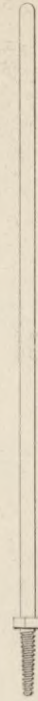

Fig. 159.

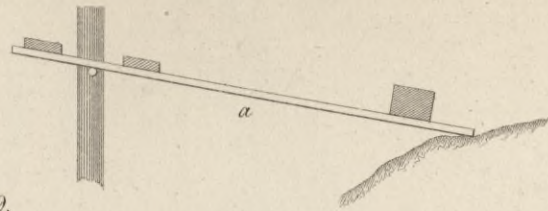

Fig. 160.

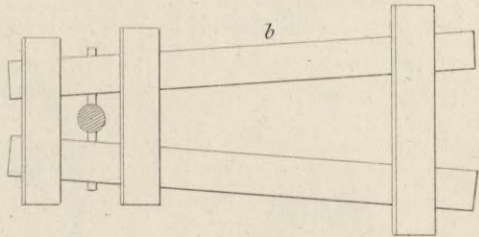

Fig. 162.

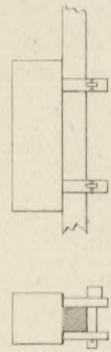

Fig. 163.

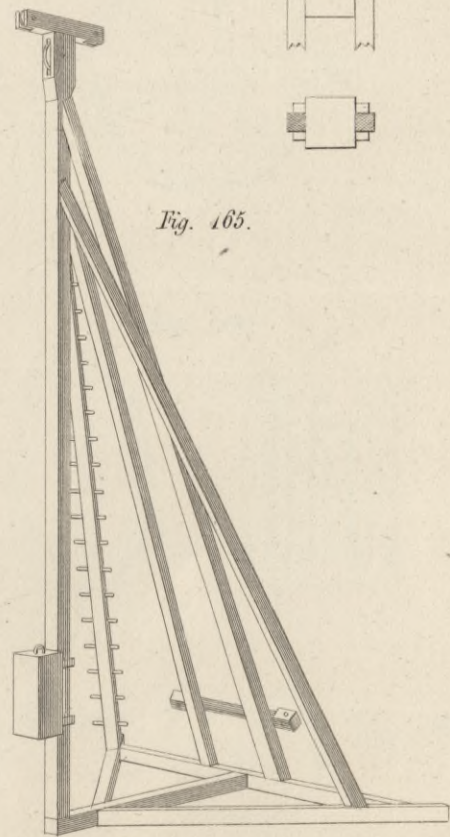

Fig. 164.

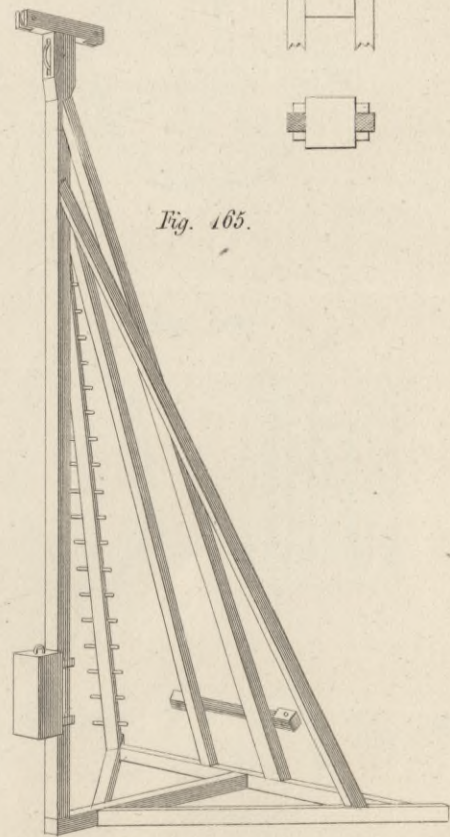

Fig. 165.

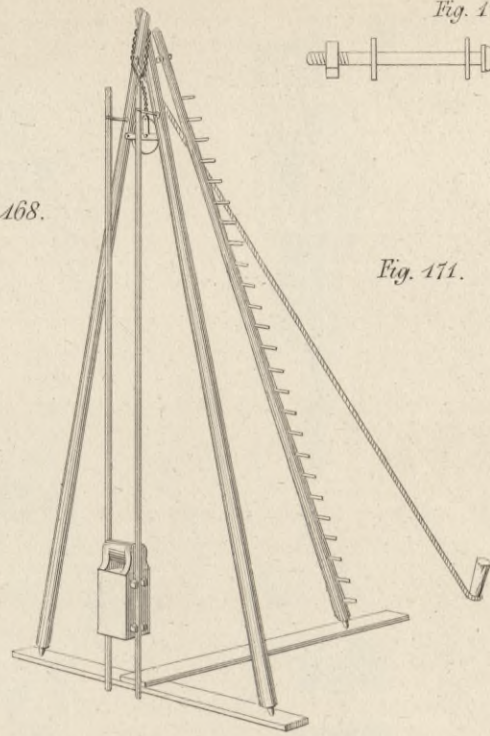

Fig. 168.

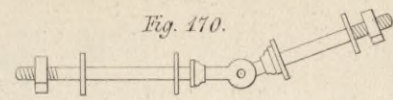

Fig. 170.

Fig. 171.

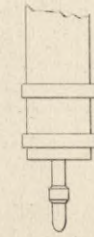

Fig. 172.

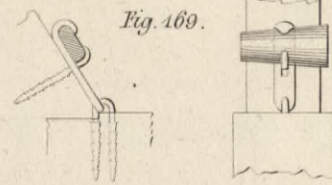

Fig. 169.

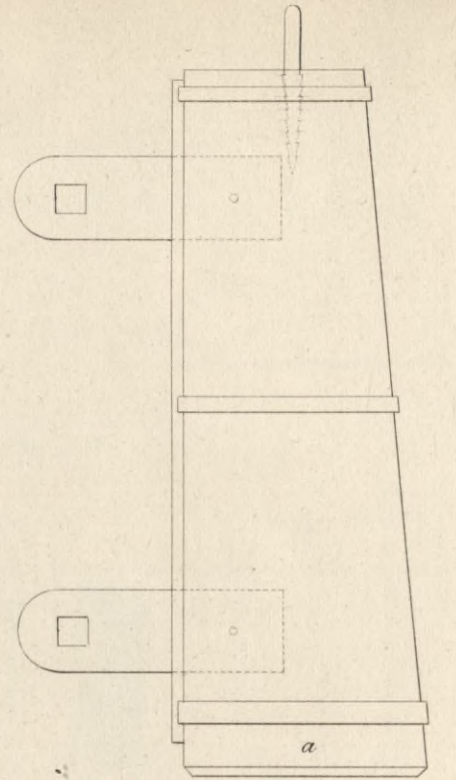

Fig. 173.

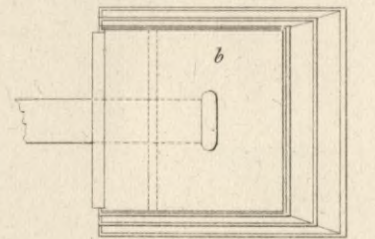

Fig. 173.

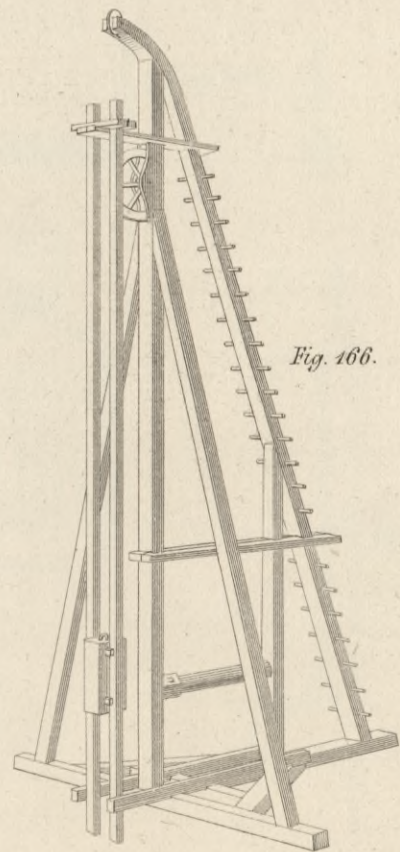
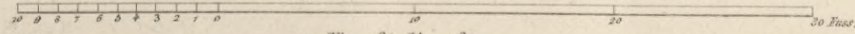
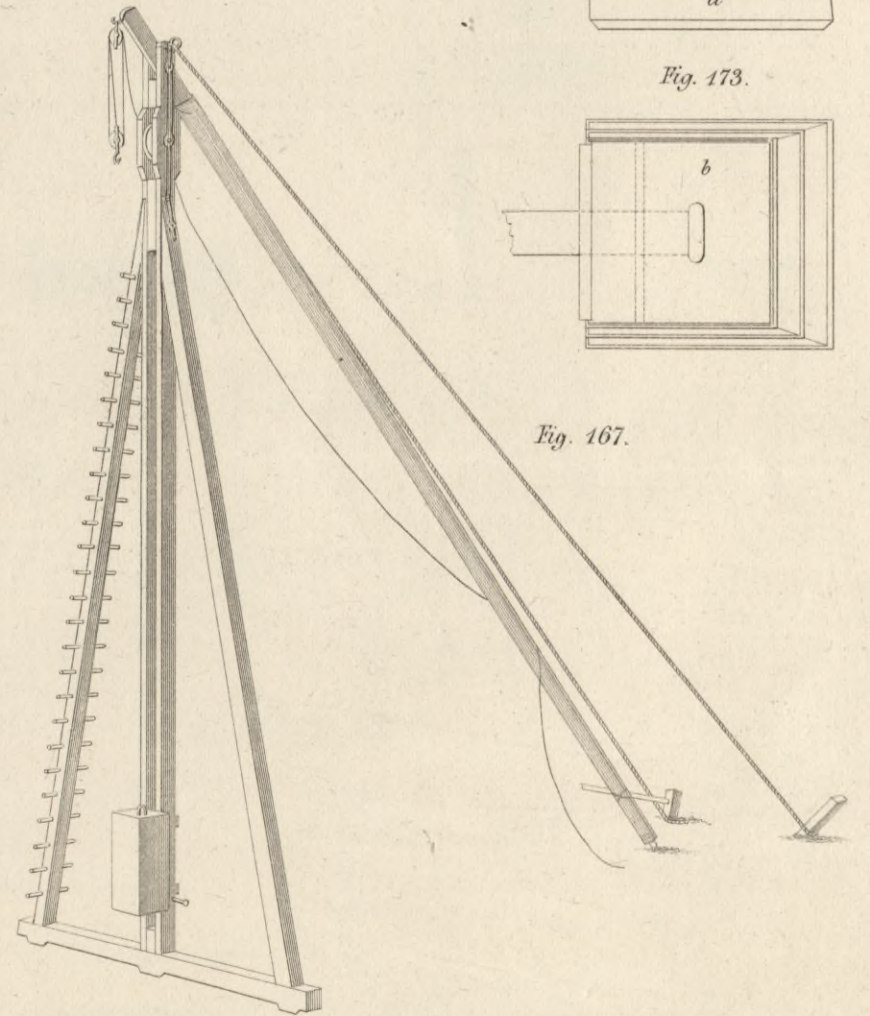
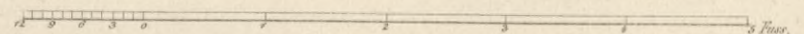

Fig. 166.



zu Fig. 164 bis 168.



zu Fig. 158, 159 und 169 bis 173.

Fig. 174.

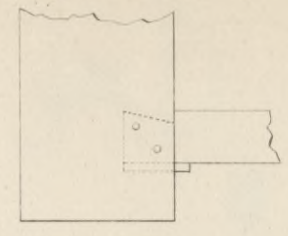

Fig. 175.

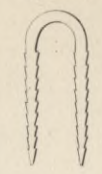

Fig. 176

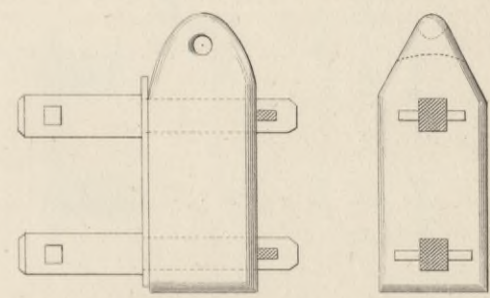

Fig. 177

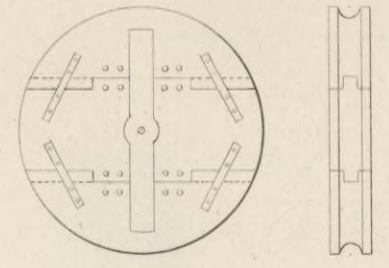

Fig. 178

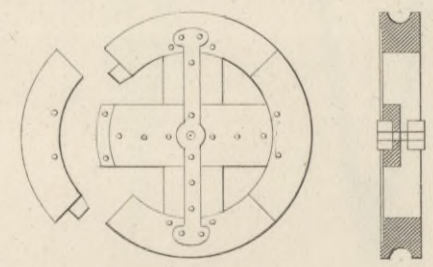

Fig. 179

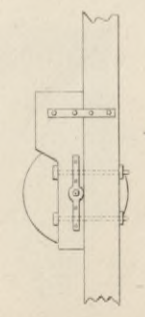

Fig. 187

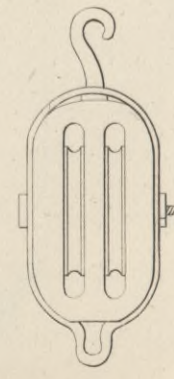

Fig. 185.

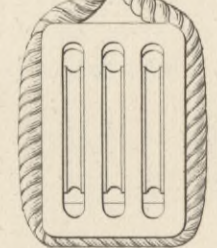
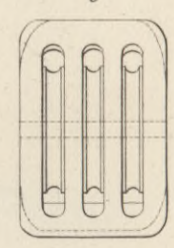
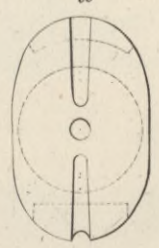

Fig. 186



Fig. 182

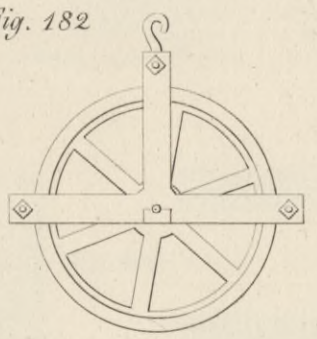

Fig. 180

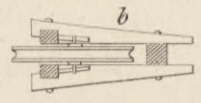

Fig. 181

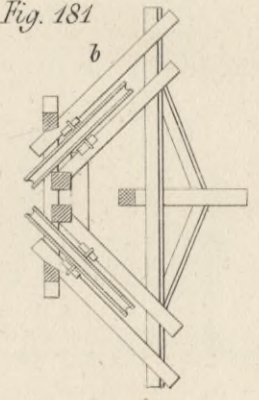

Fig. 183



Fig. 192

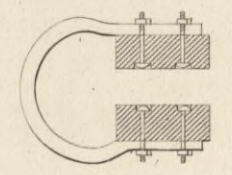

Fig. 184

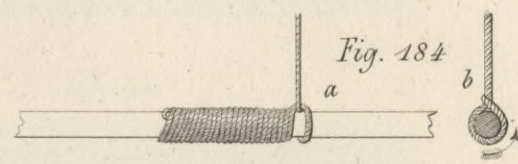

Fig. 191

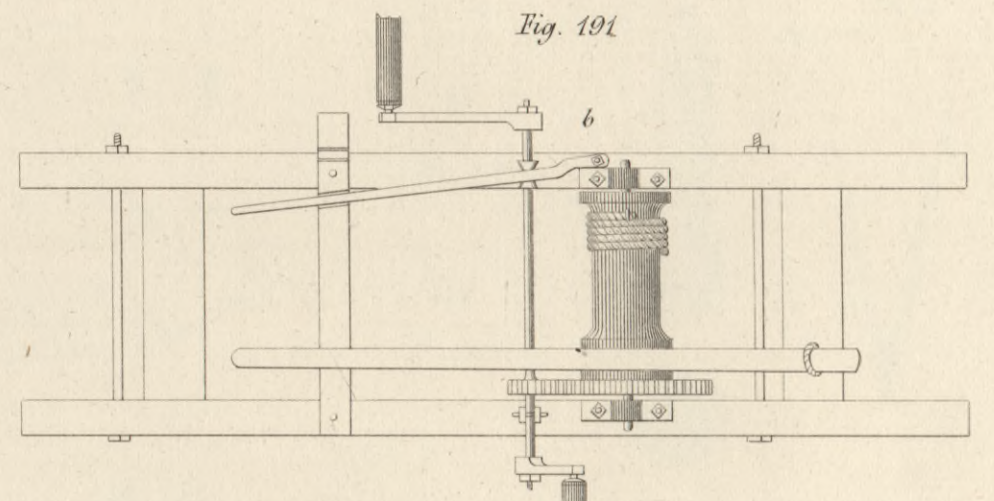

Fig. 190

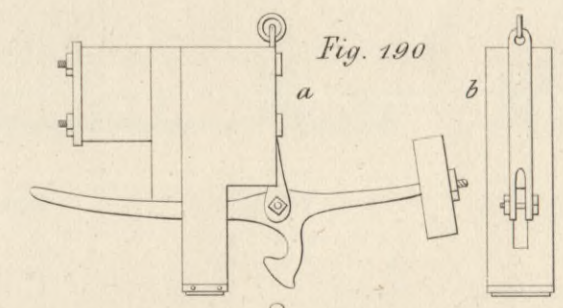

Fig. 189

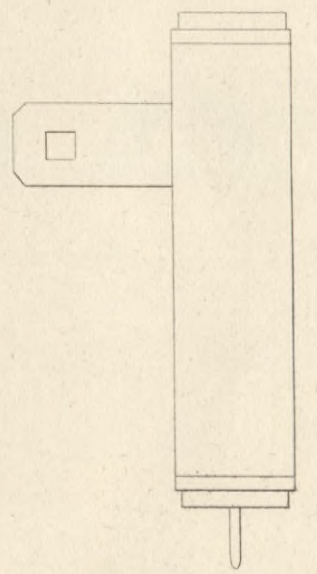
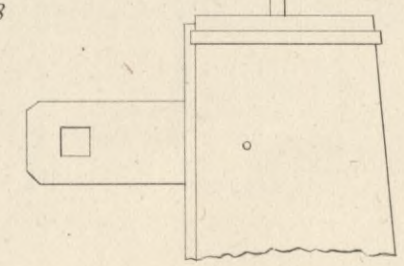

Fig. 188



zu Fig. 174 bis 178 und 189 bis 192. 5 Fuss.
zu Fig. 184 bis 187. 2 Fuss.

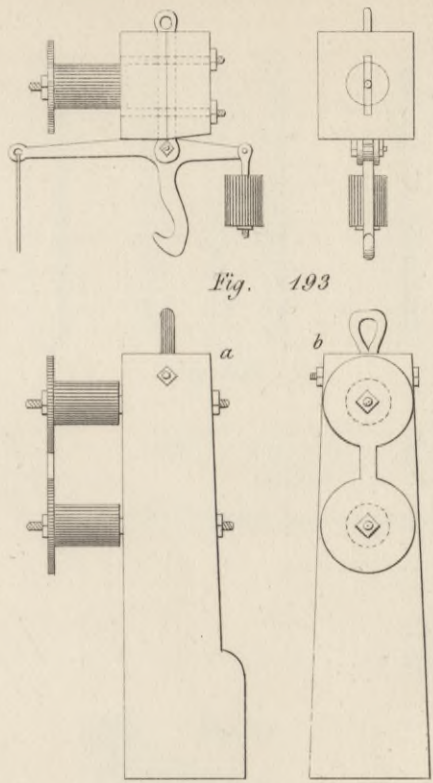

Fig. 193

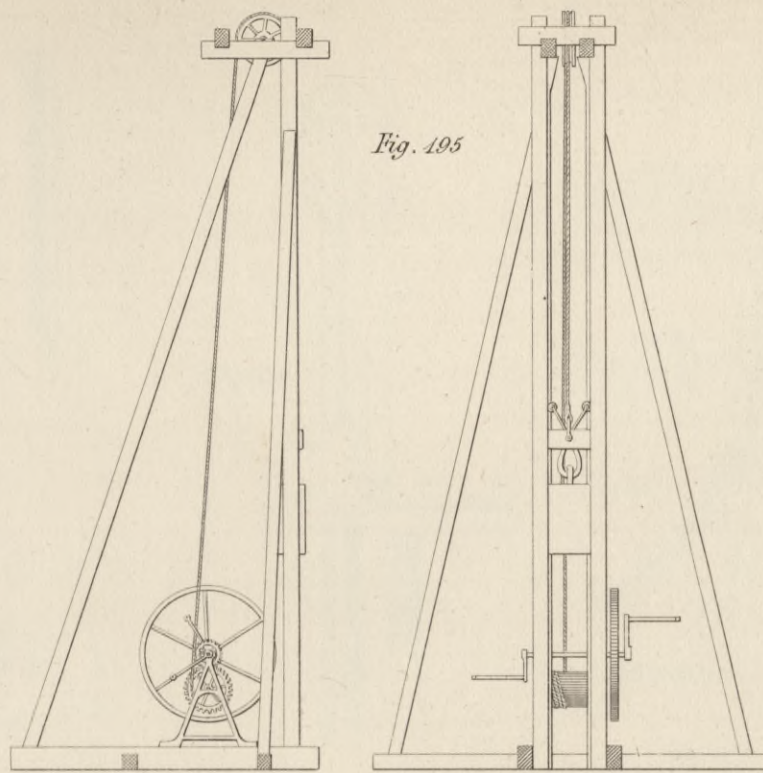

Fig. 195

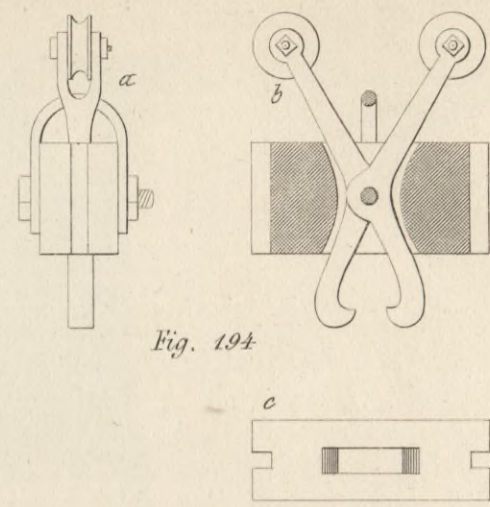

Fig. 194

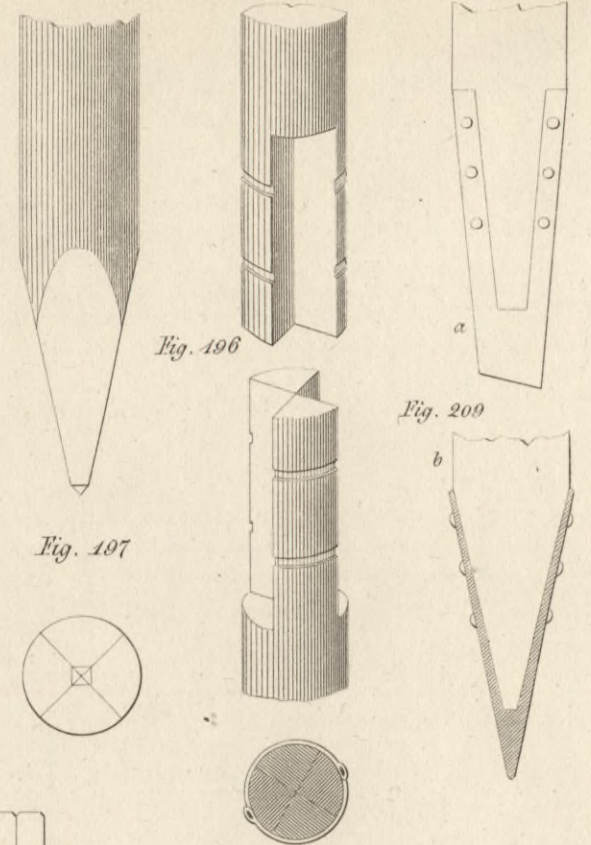

Fig. 196

Fig. 197

Fig. 200

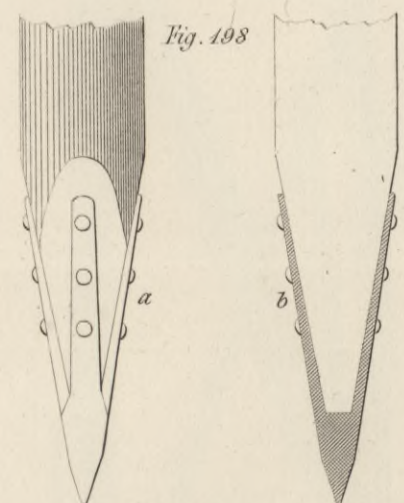

Fig. 198

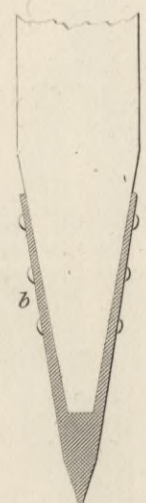
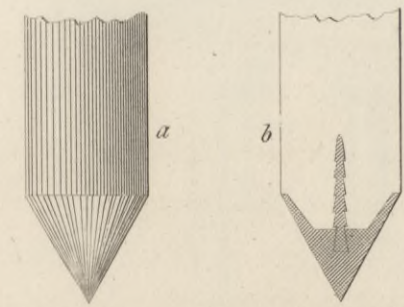
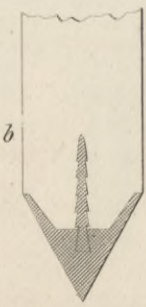

Fig. 199



a



b



Fig. 203

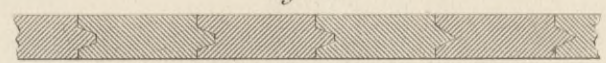

Fig. 204



Fig. 205



Fig. 206

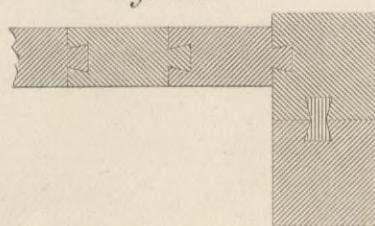

Fig. 207

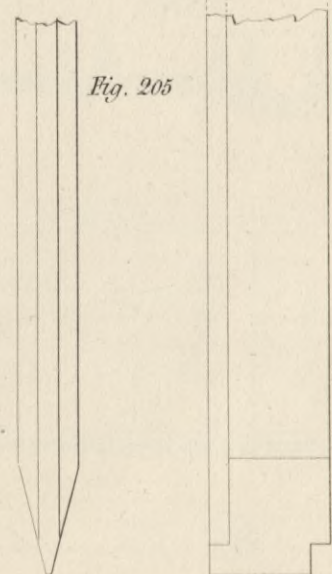

Fig. 208

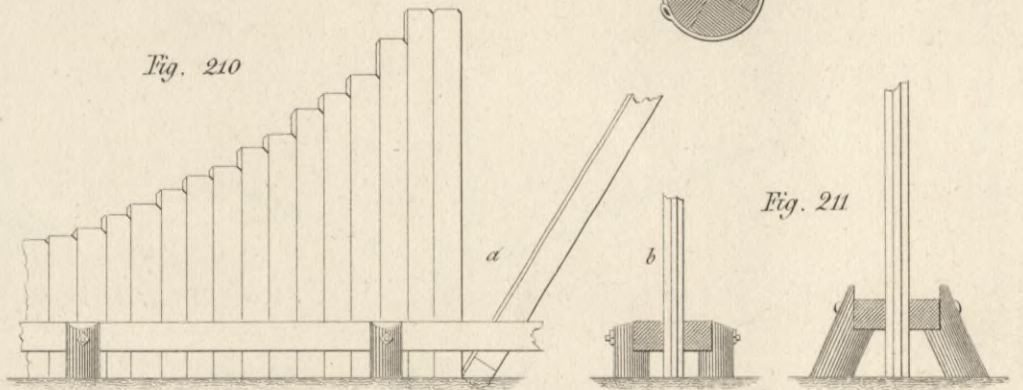

Fig. 209

Fig. 211

Fig. 210

Fig. 212

zu Fig. 193 bis 194 u. 196 bis 199 u. 201 bis 206 u. 209. 5 Fuss.
 zu Fig. 195 u. 210 bis 212. 10 Fuss.

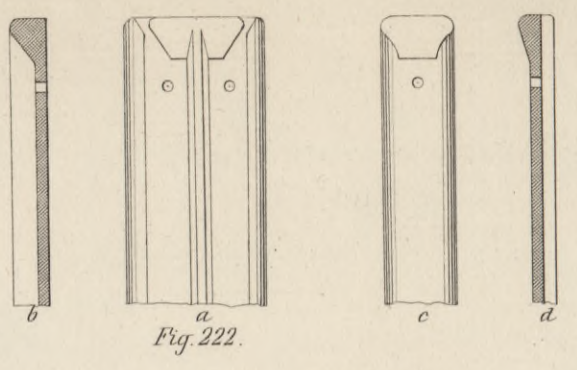

Fig. 222.

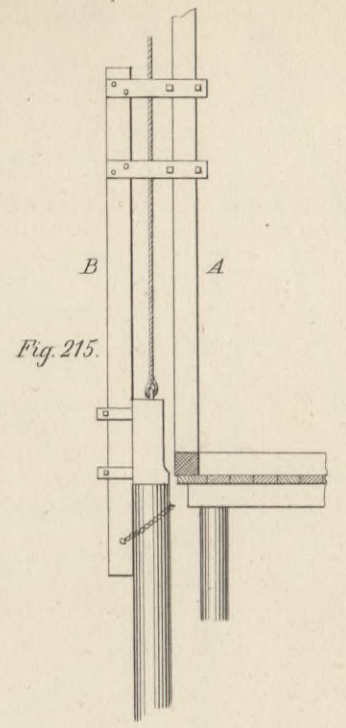
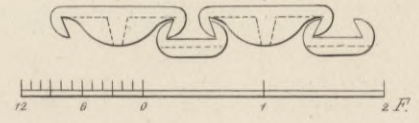

Fig. 215.

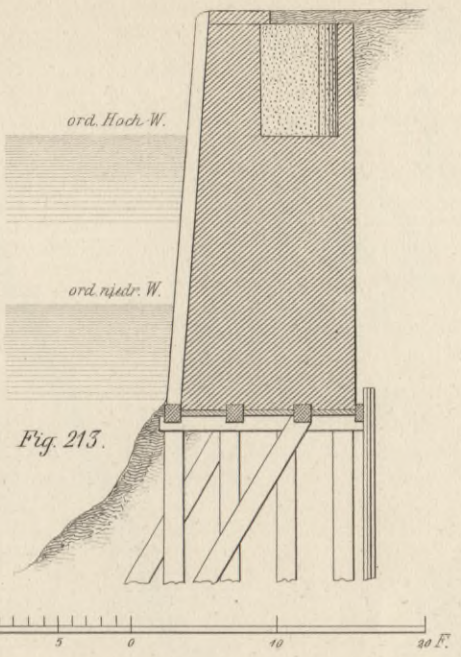

Fig. 213.

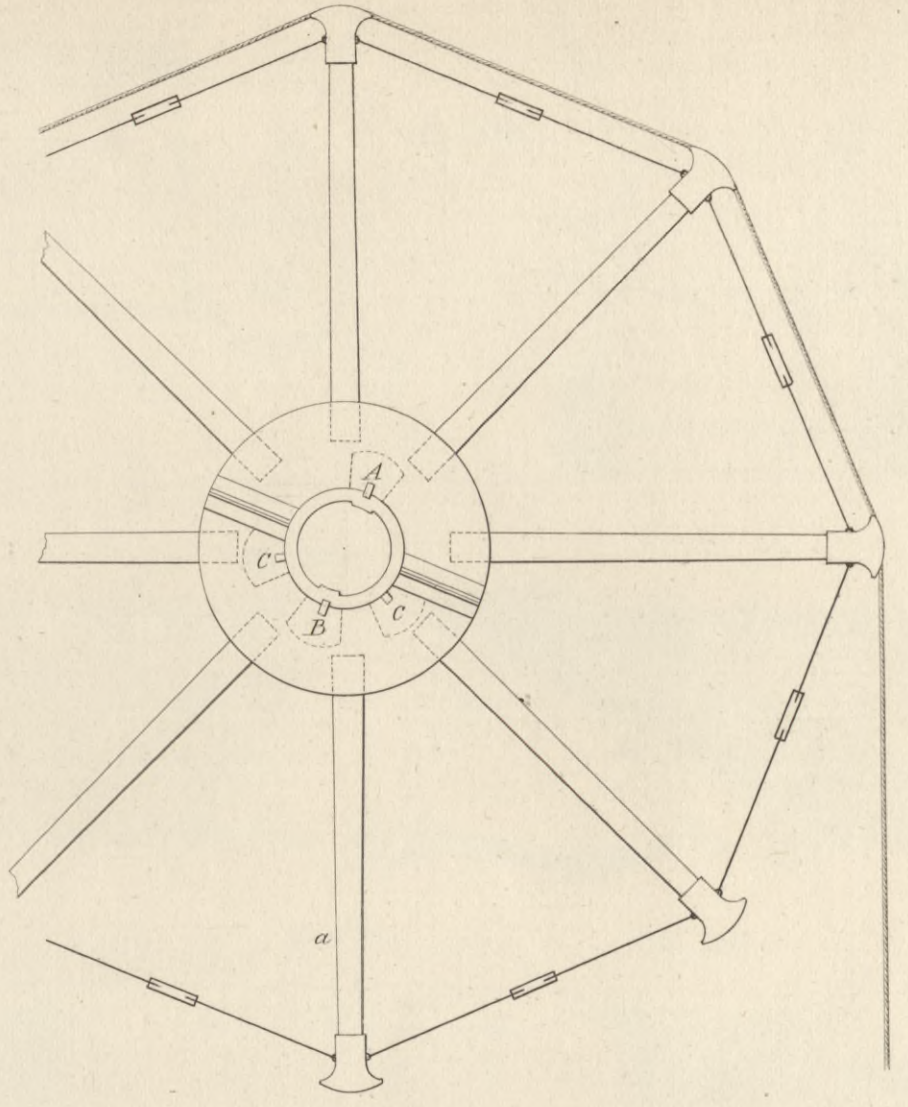

Fig. 217.

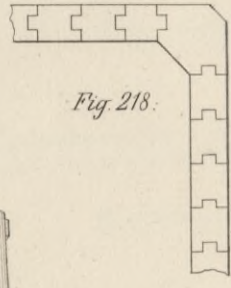

Fig. 218.

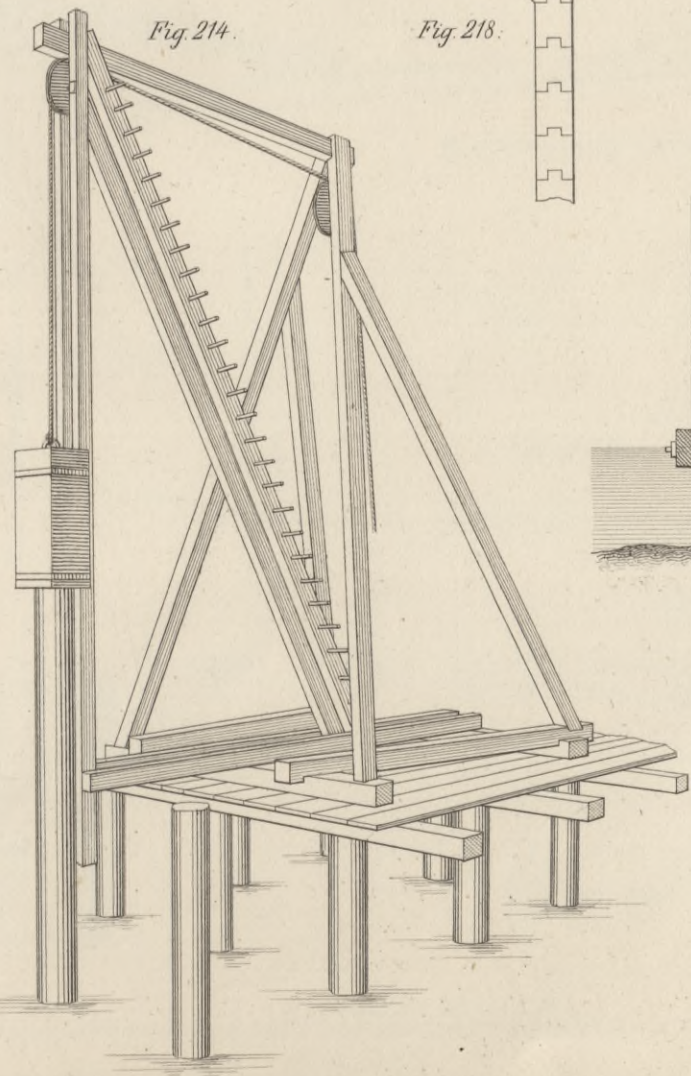

Fig. 214.

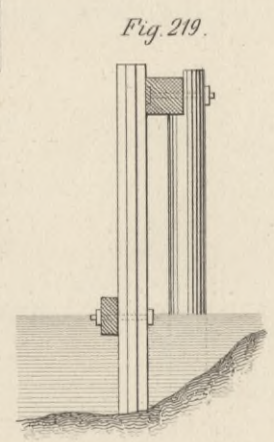

Fig. 219.

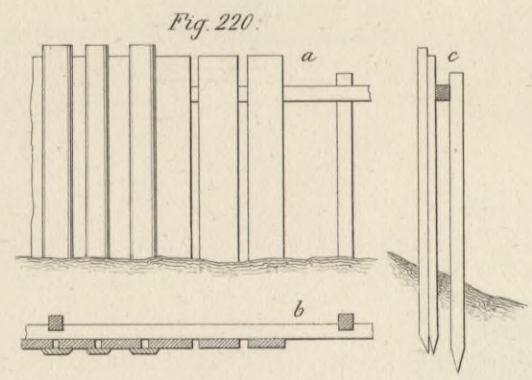

Fig. 220.

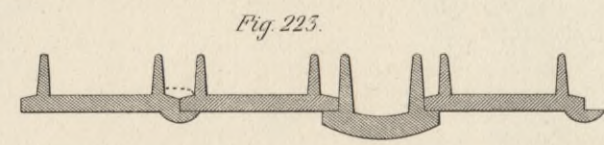

Fig. 223.

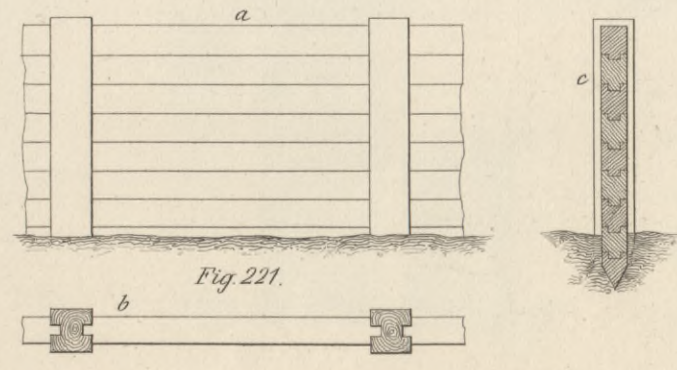

Fig. 221.

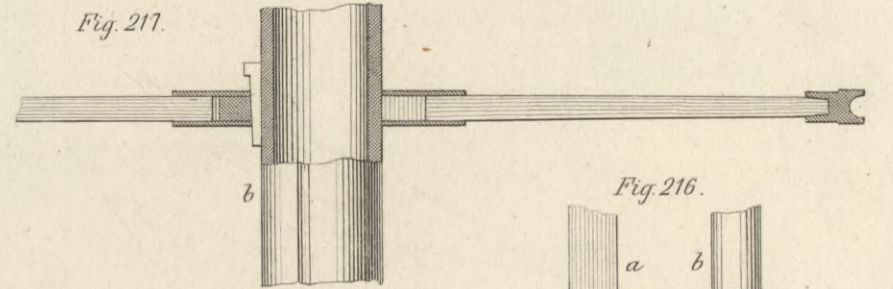
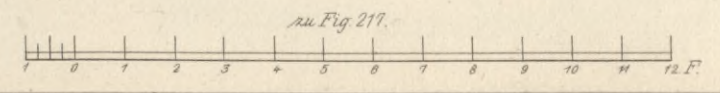

Fig. 216.



zu Fig. 217.

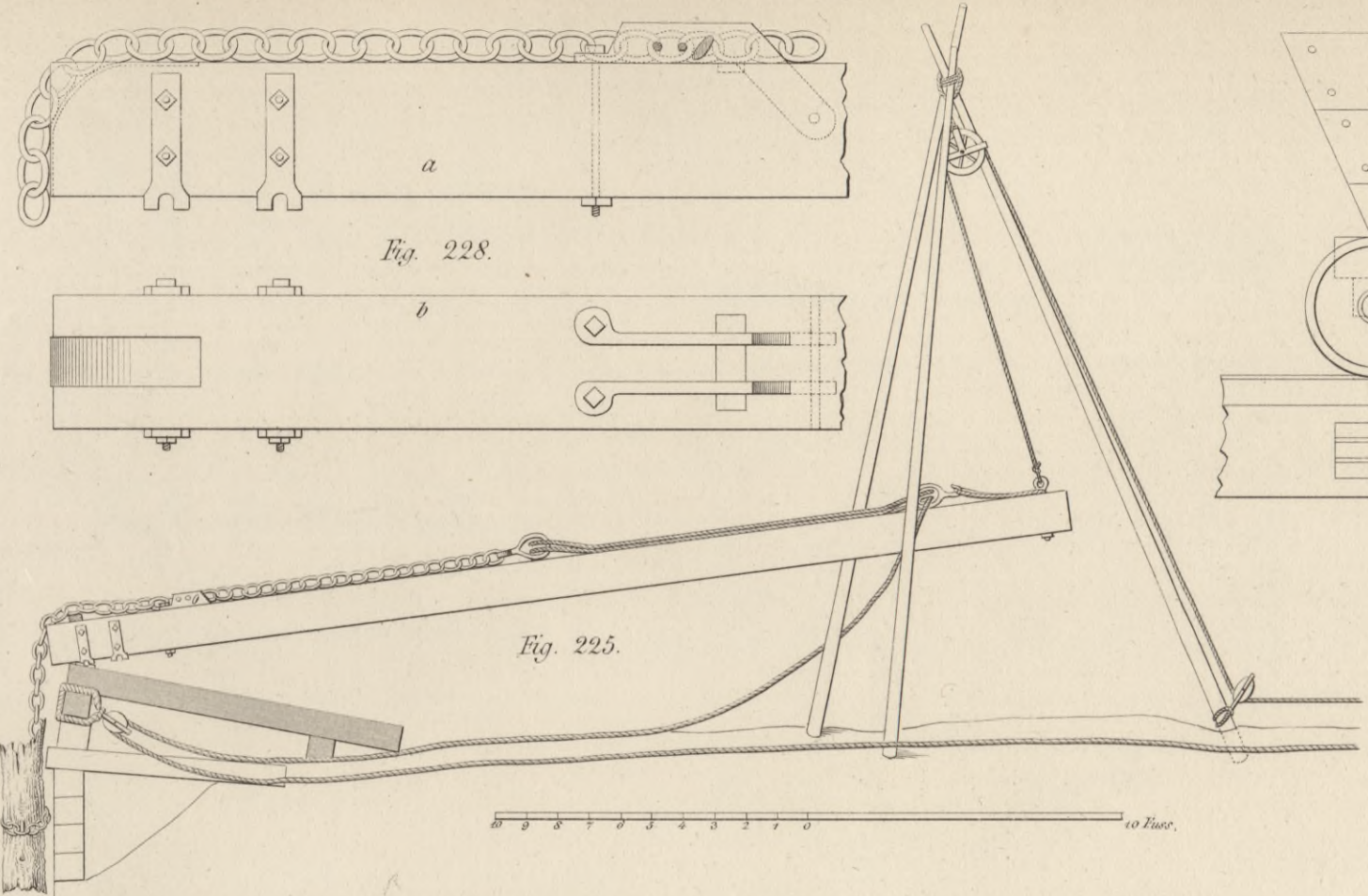

Fig. 228.

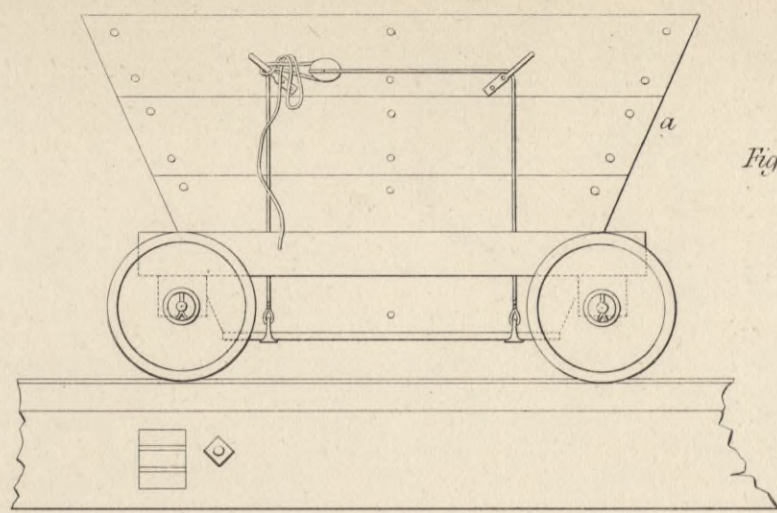
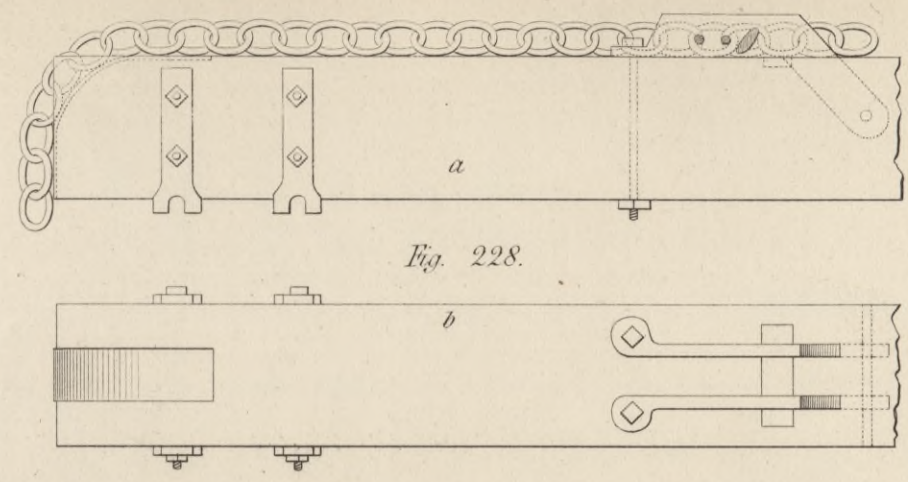

Fig. 230.

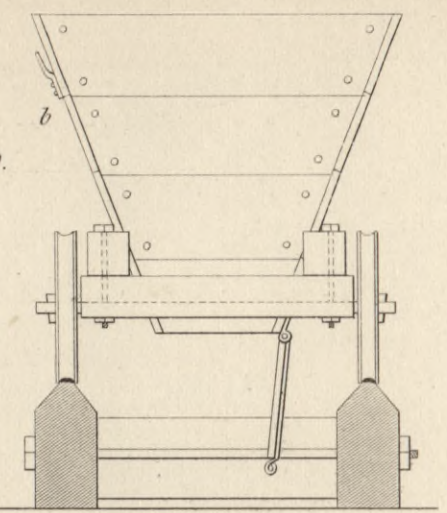
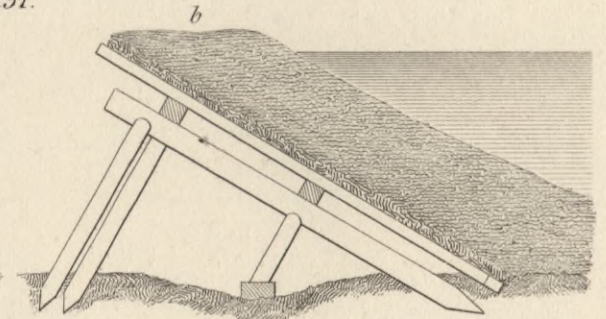
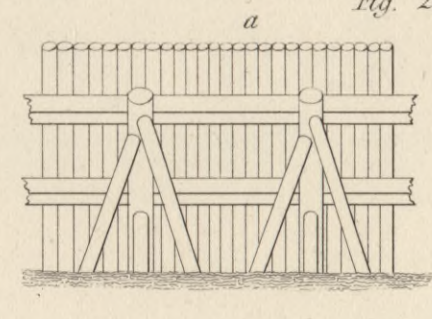

Fig. 231.



60 Fuss.

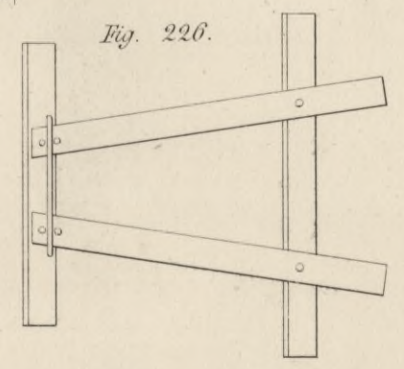

Fig. 226.

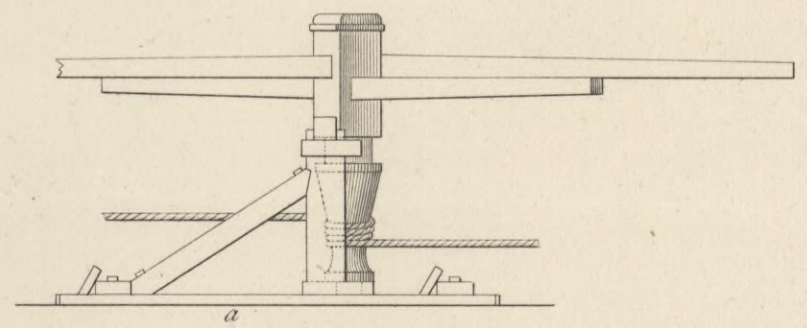

Fig. 229.

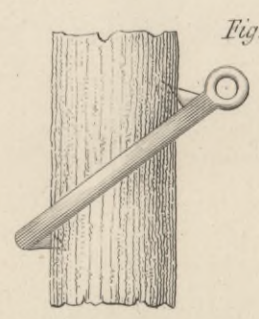
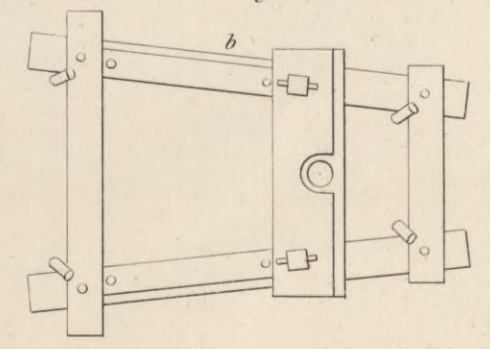

Fig. 227.

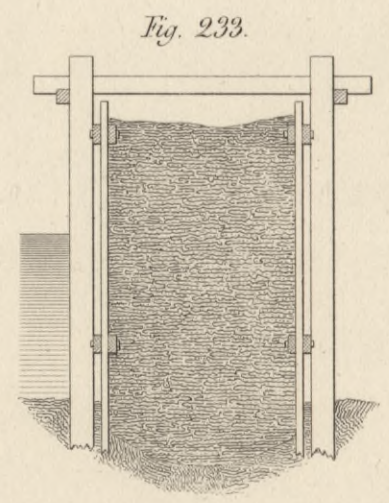

Fig. 233.

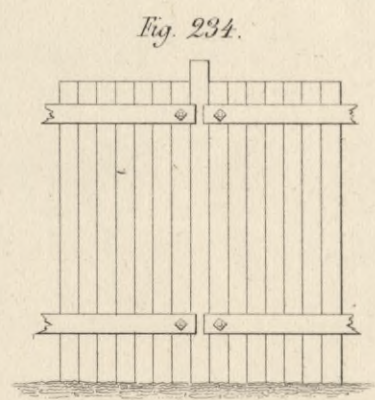

Fig. 234.

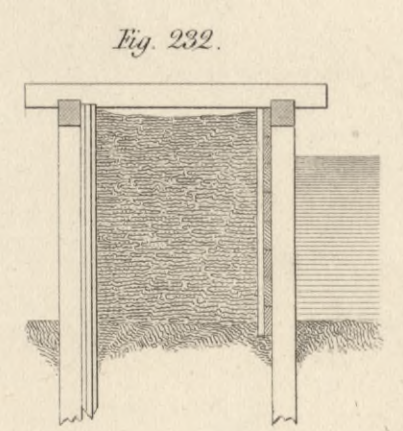

Fig. 232.

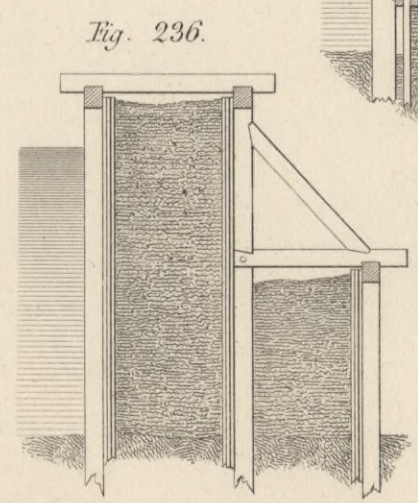

Fig. 236.

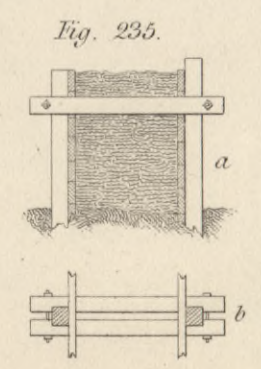

Fig. 235.

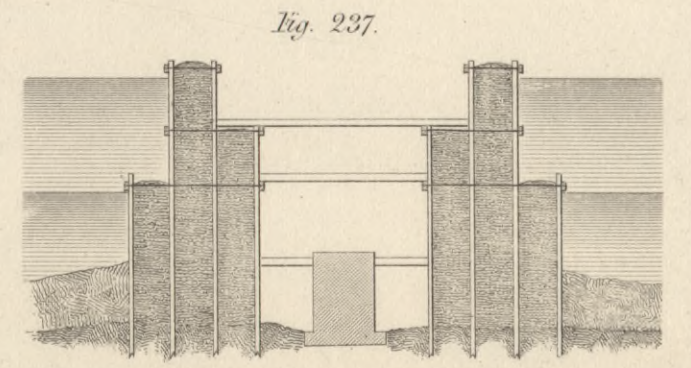

Fig. 237.

zu Fig. 227, 228 und 230. 5 Fuss.
 zu Fig. 229. 12 Fuss.

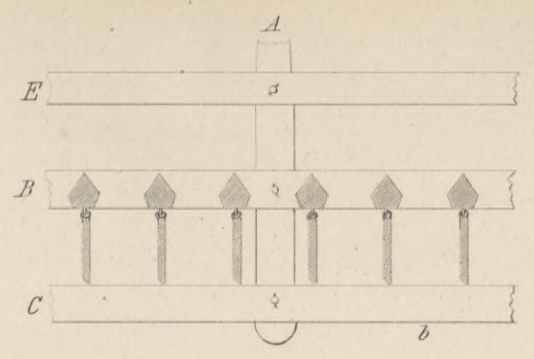

Fig. 238.

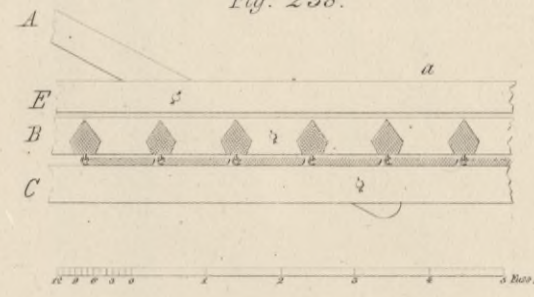

Fig. 239.

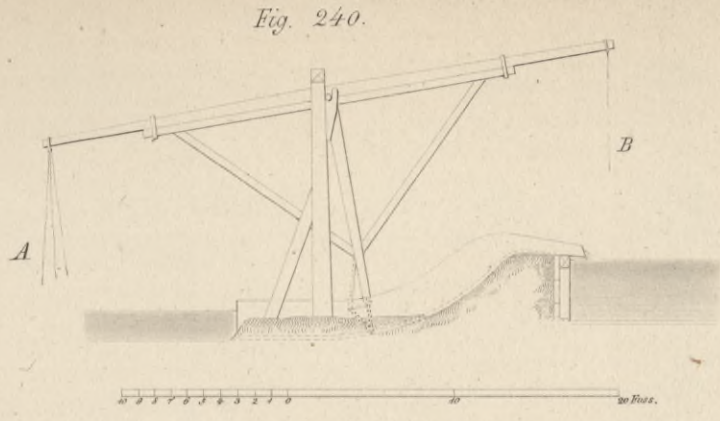

Fig. 240.

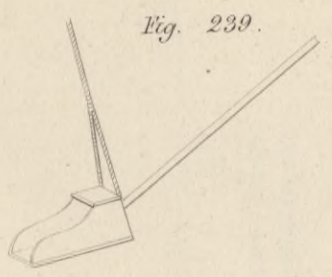

Fig. 241.

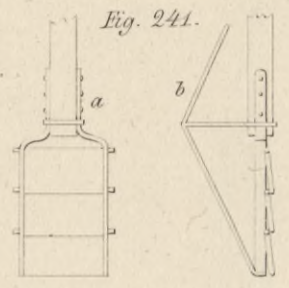

Fig. 242.

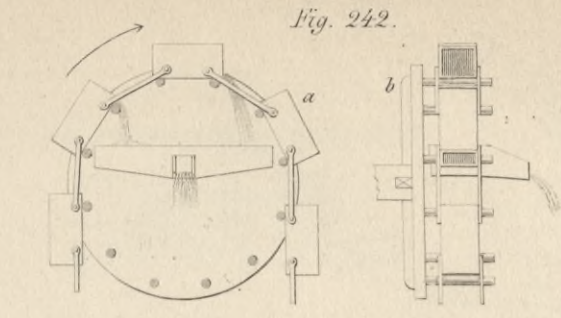

Fig. 243.

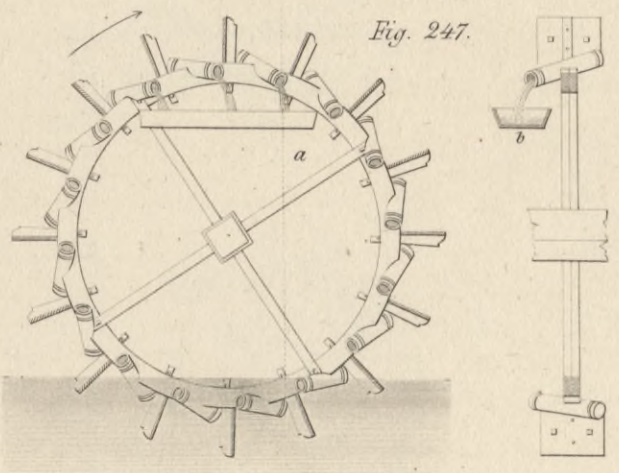

Fig. 244.

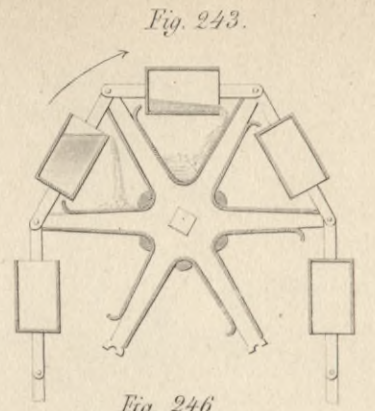

Fig. 245.

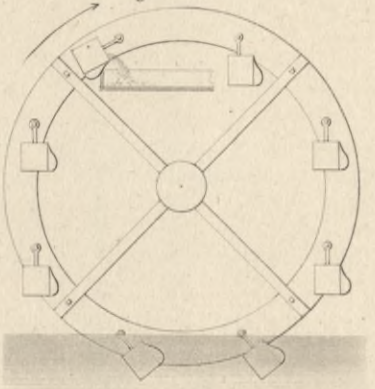

Fig. 246.

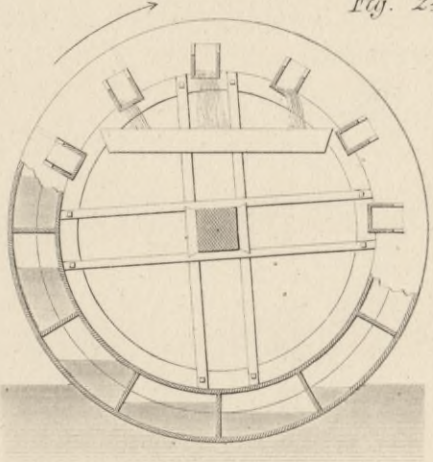

Fig. 247.

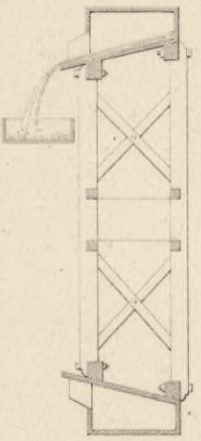

Fig. 248.

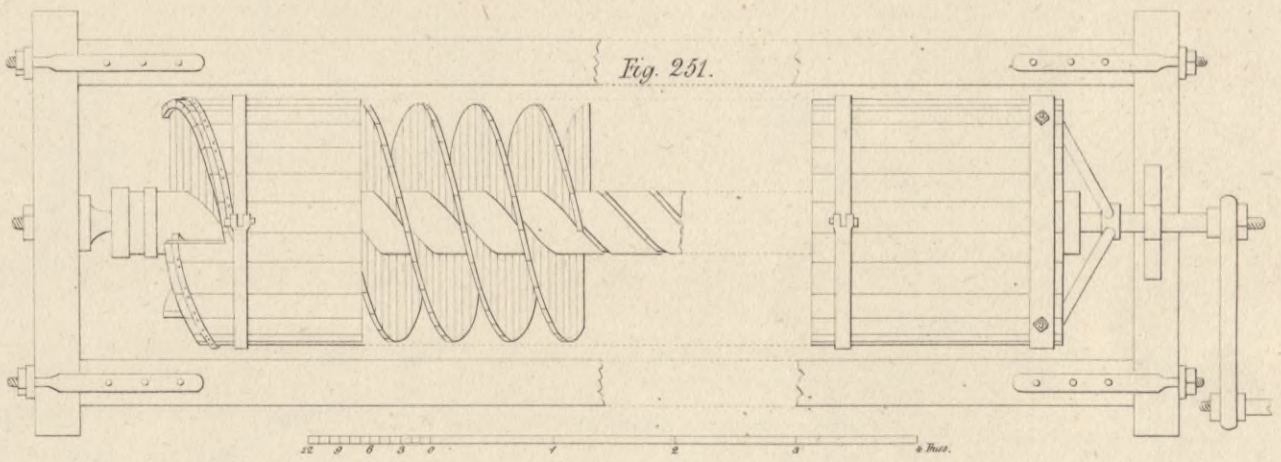

Fig. 249.

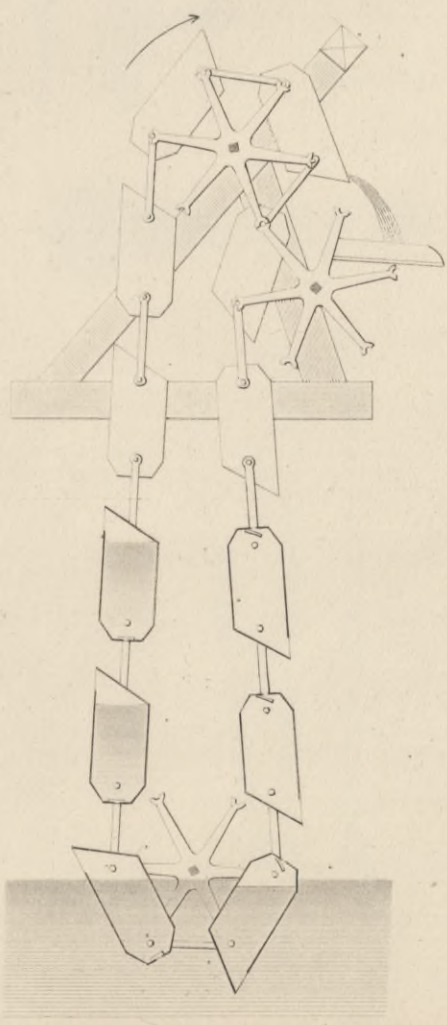

Fig. 250.

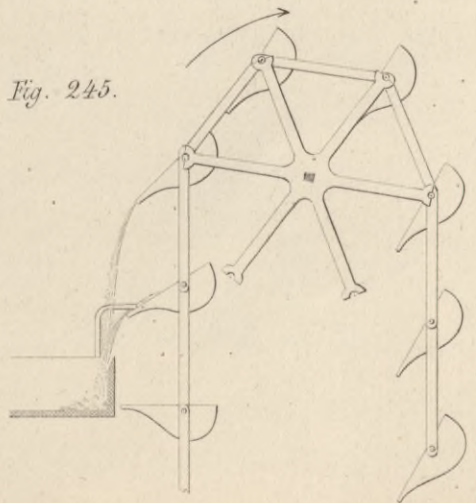

Fig. 251.

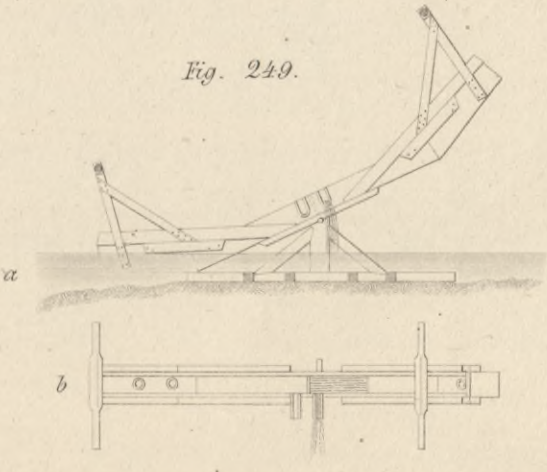

Fig. 252.

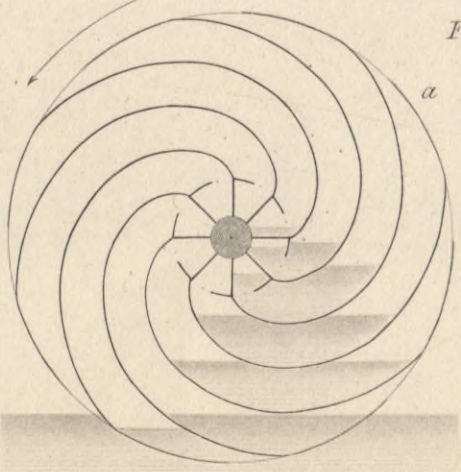

Fig. 253.

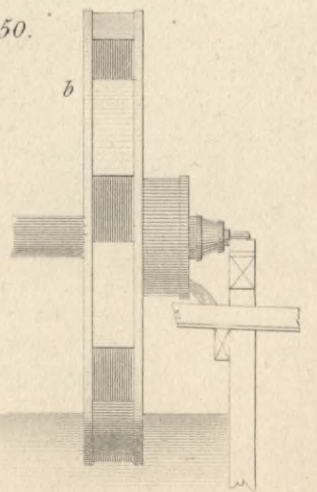

Fig. 254.

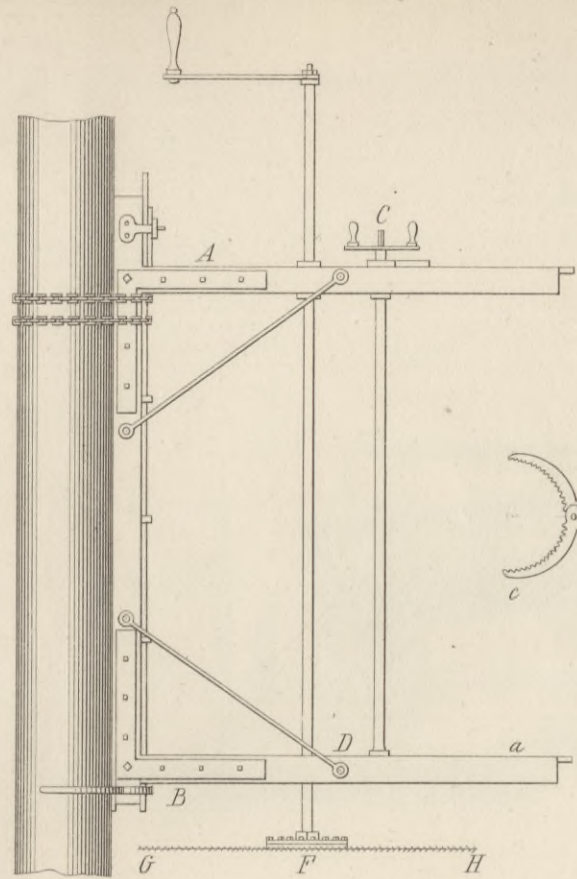

Fig. 253.

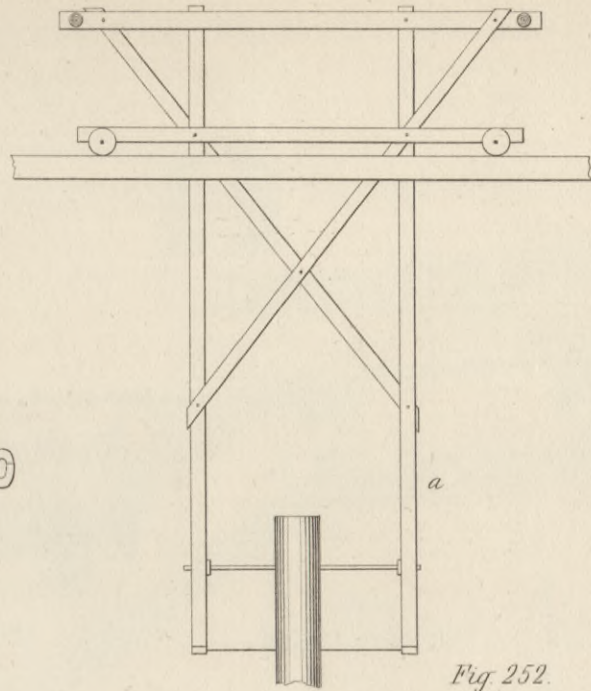
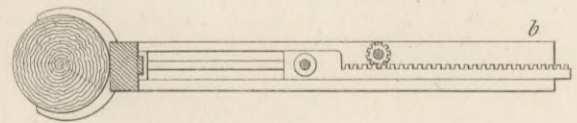

Fig. 252.

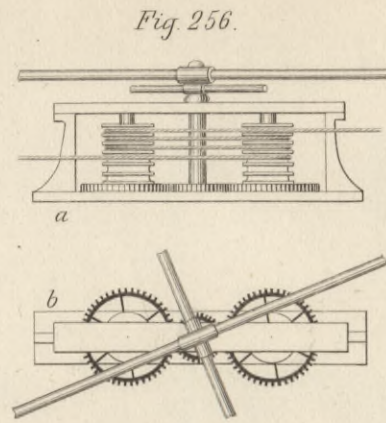
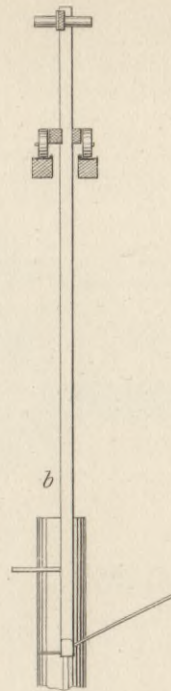
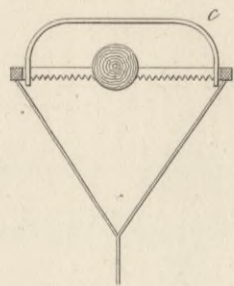

Fig. 256.

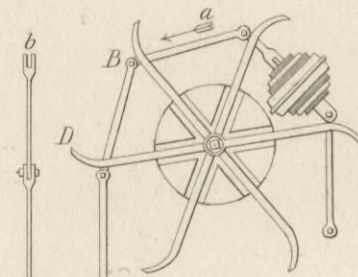
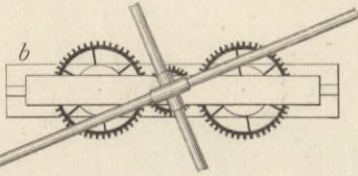

Fig. 260.

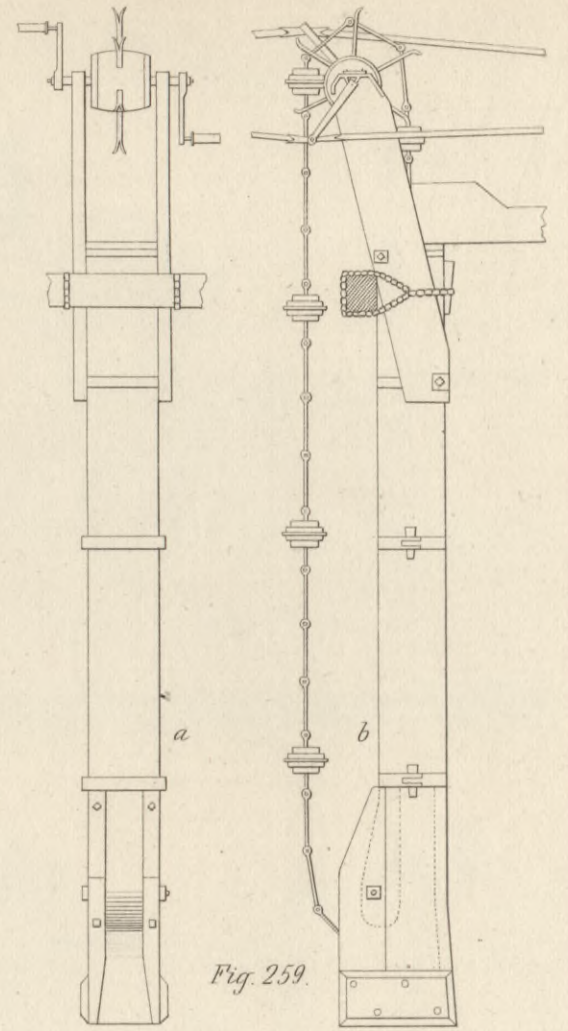
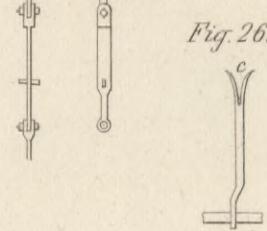

Fig. 259.

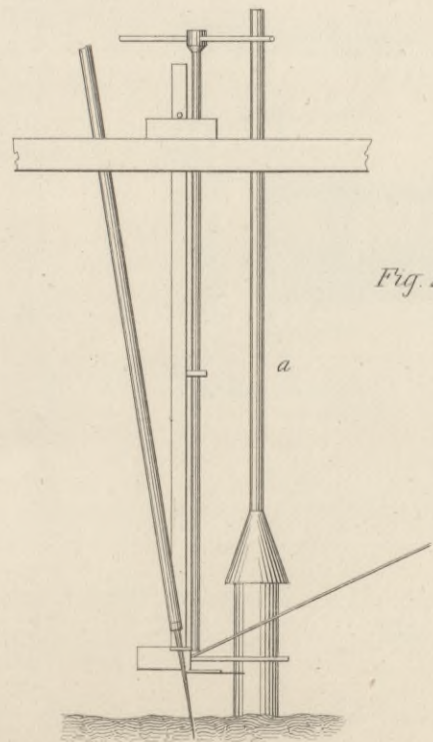

Fig. 254.

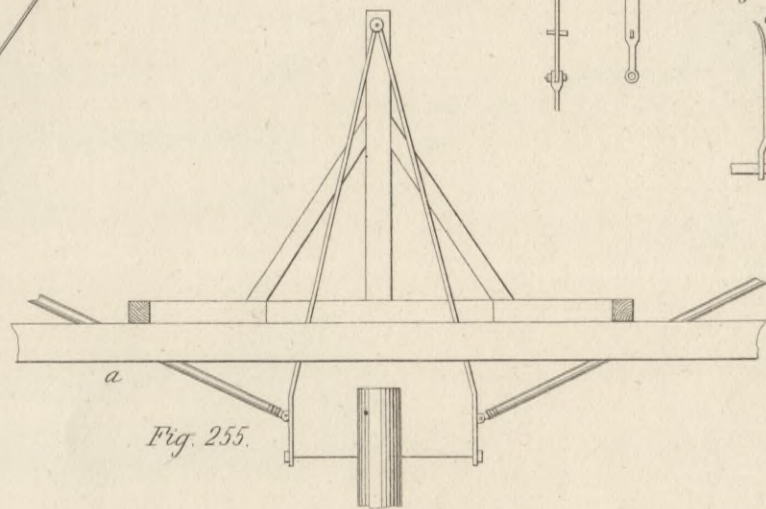
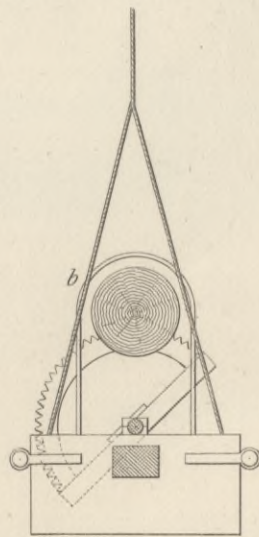

Fig. 255.

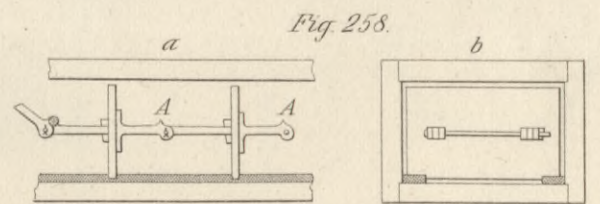
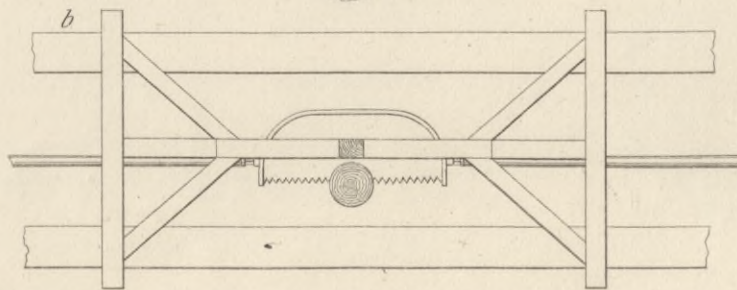

Fig. 258.

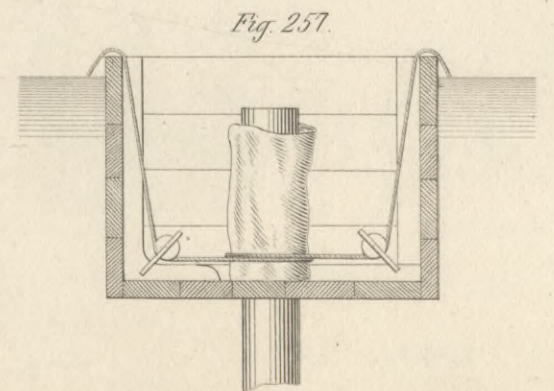
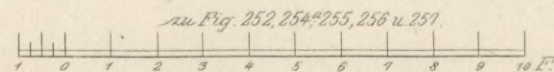

Fig. 257.



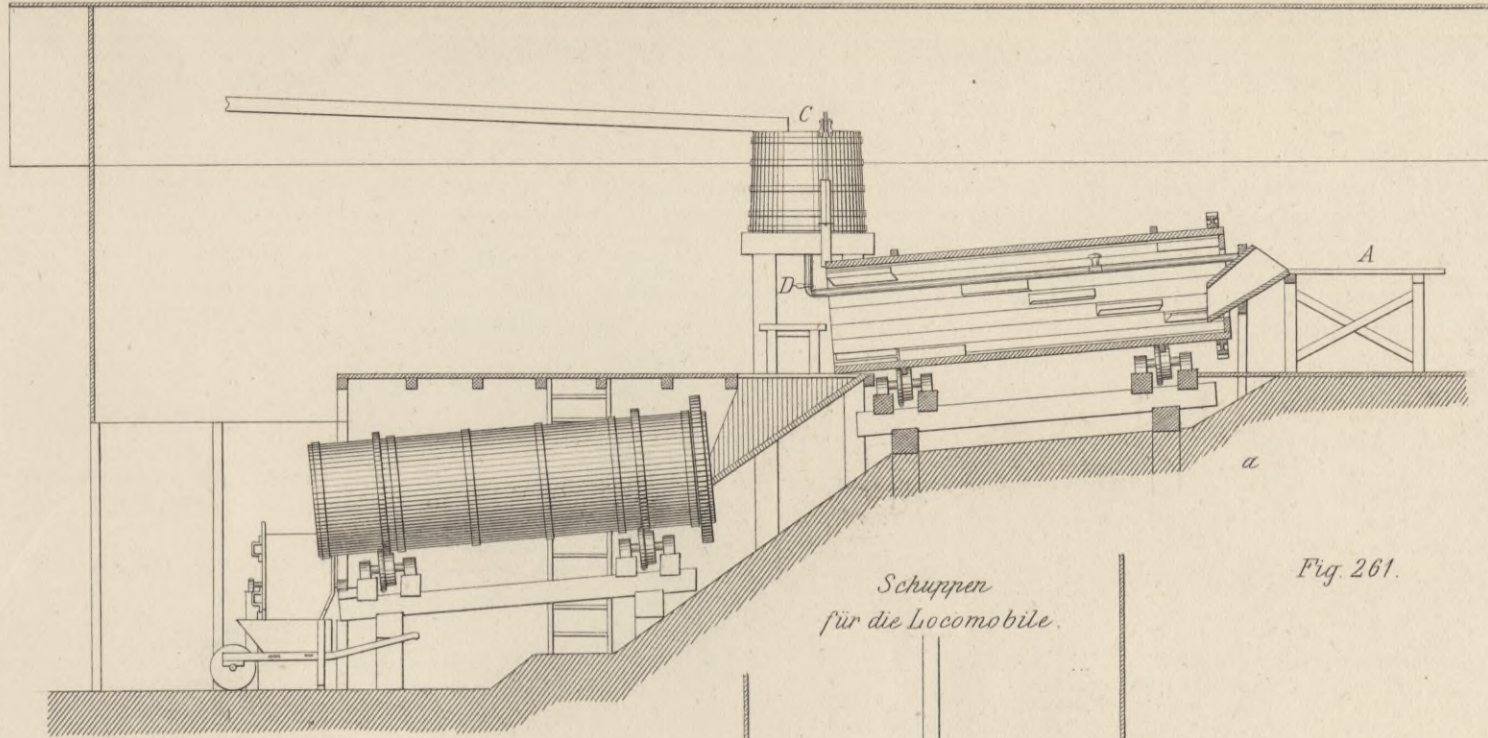
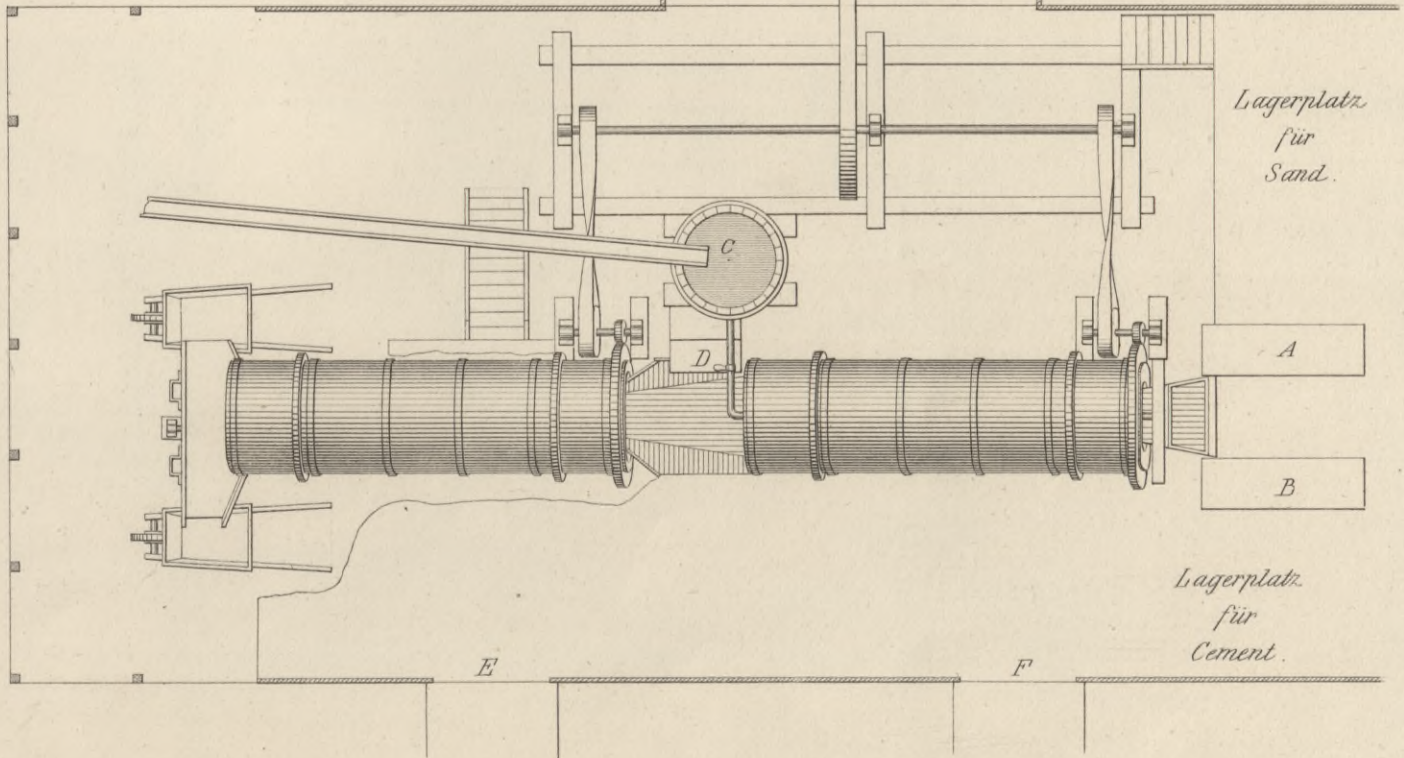
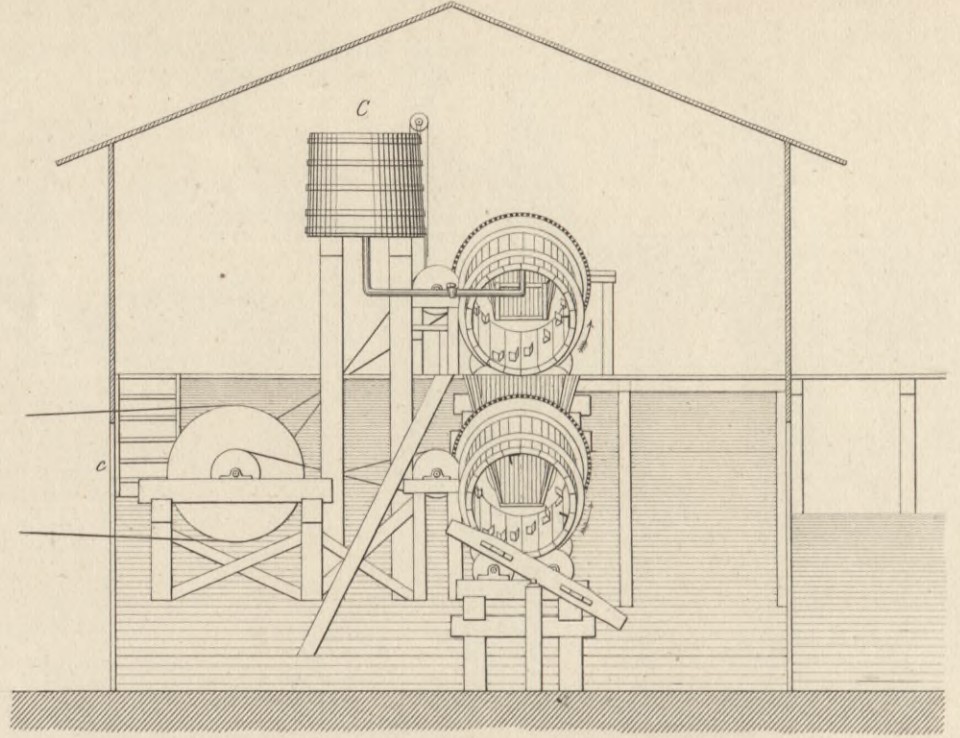

Fig. 261.



Lagerplatz für Sand.

Lagerplatz für Cement.

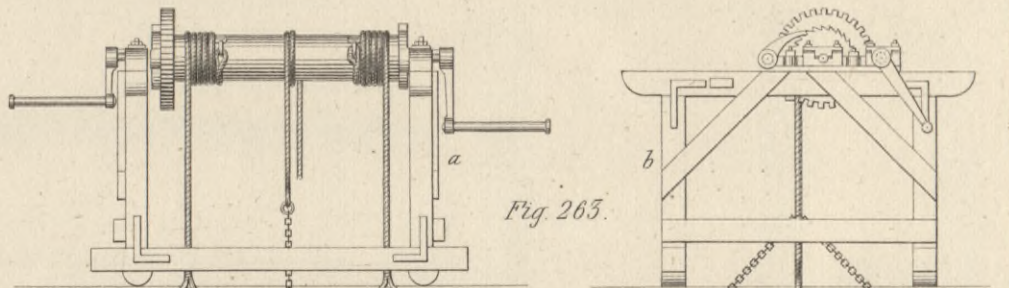
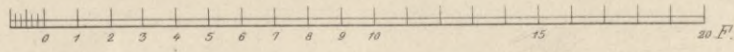

Fig. 263.

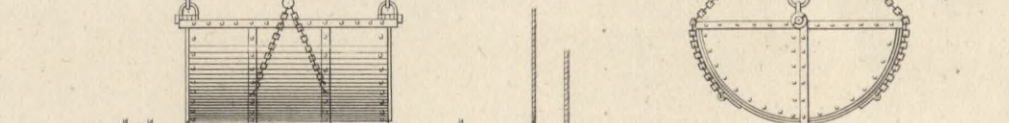

Fig. 262.

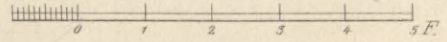
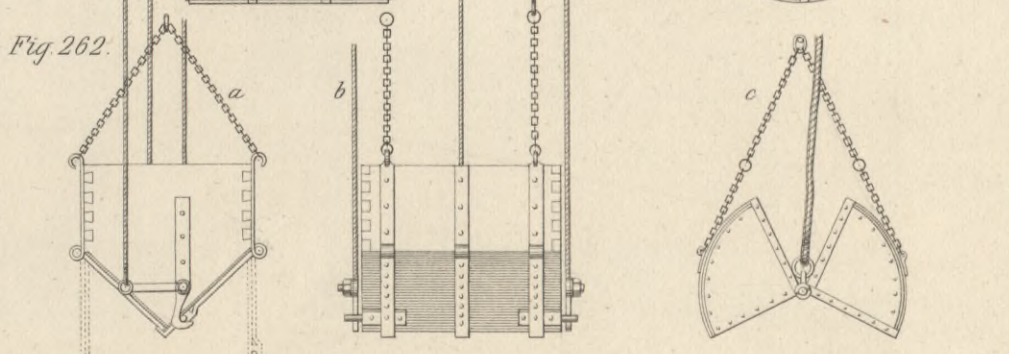
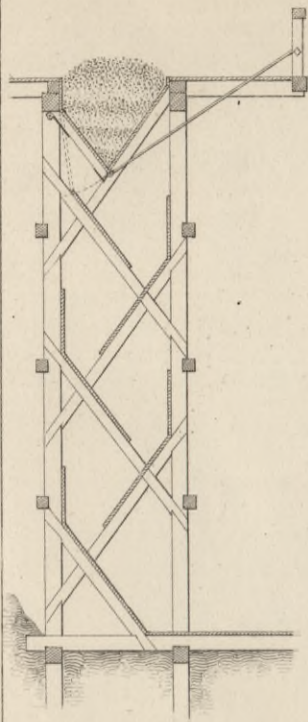
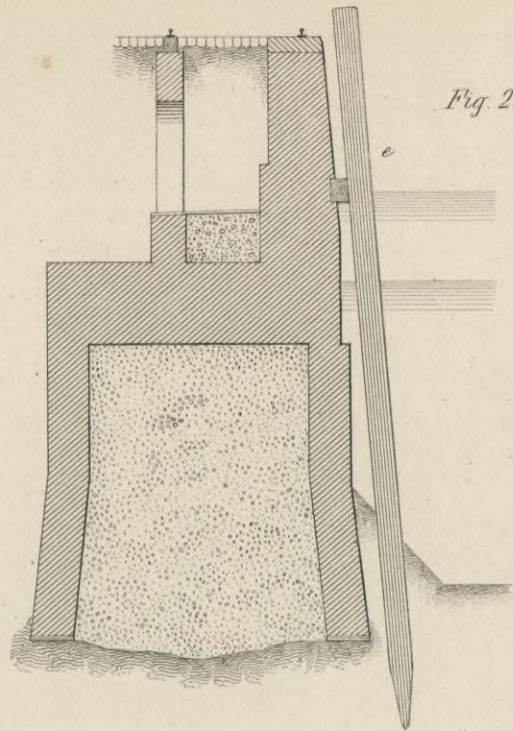

Fig. 264.



nach A B.



nach C D.

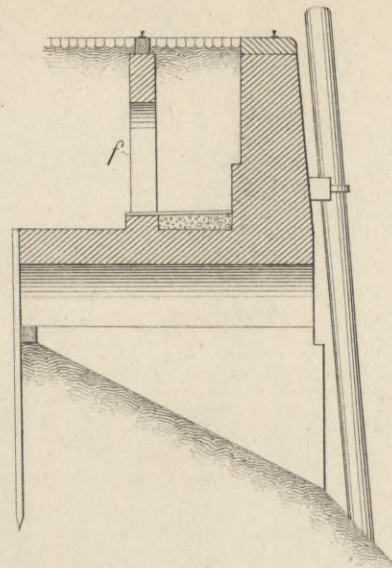
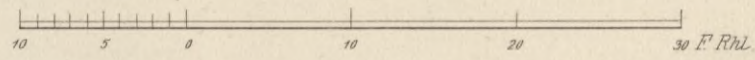
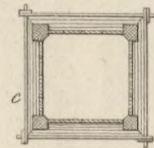
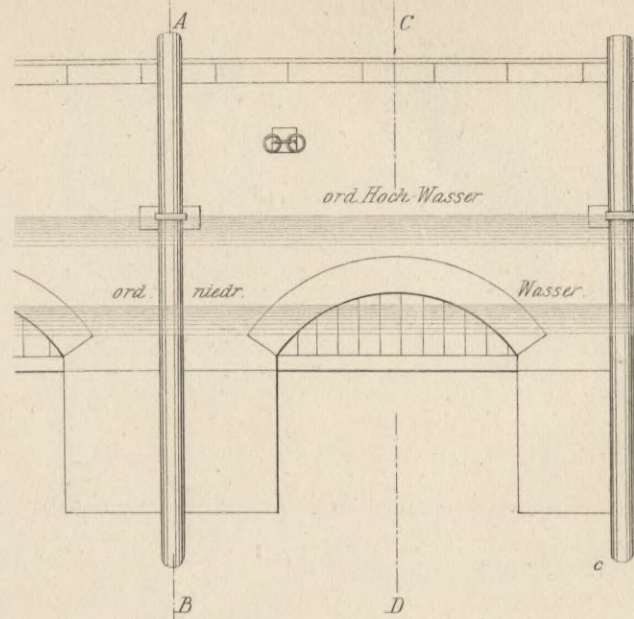

Fig. 268.



äußere Ansicht.



Durchschnitt.

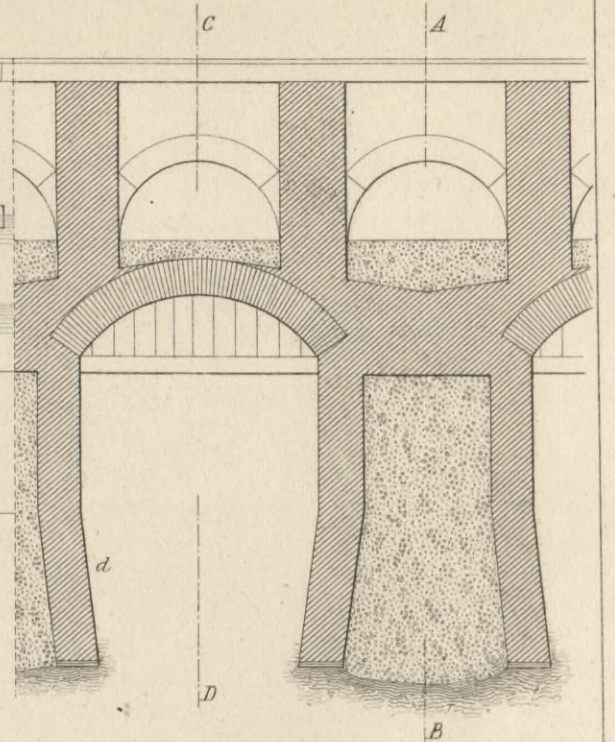
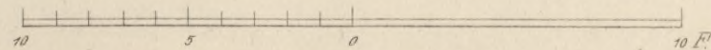
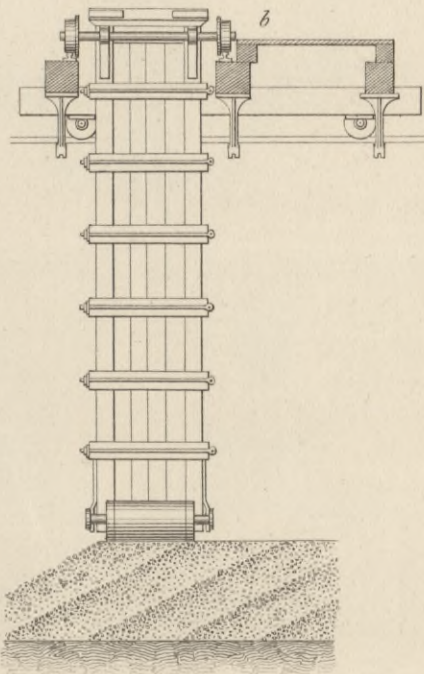
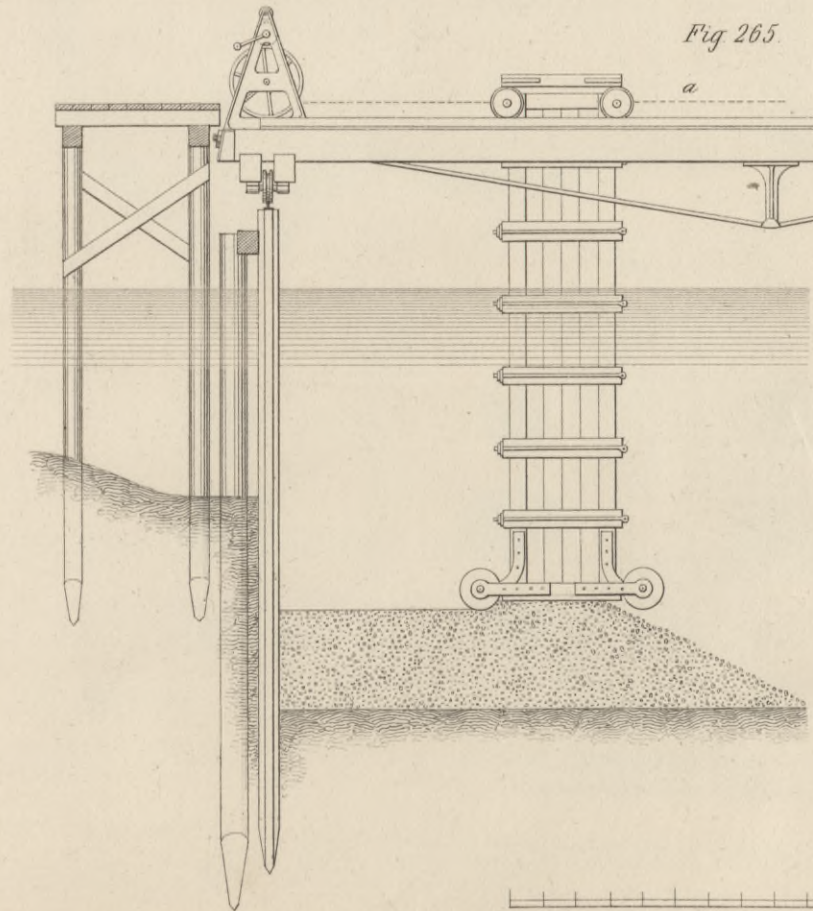
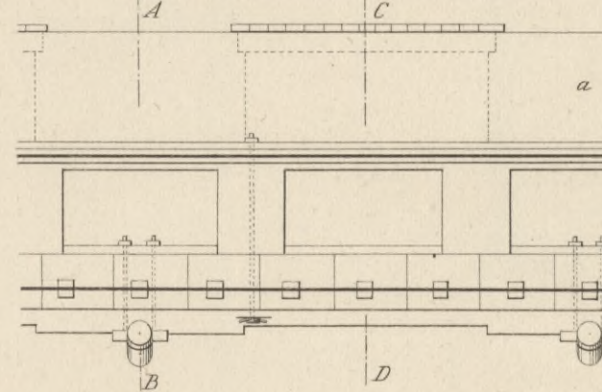

Fig. 268.

Fig. 265.



obere Ansicht.



horiz. Durchschnitt.

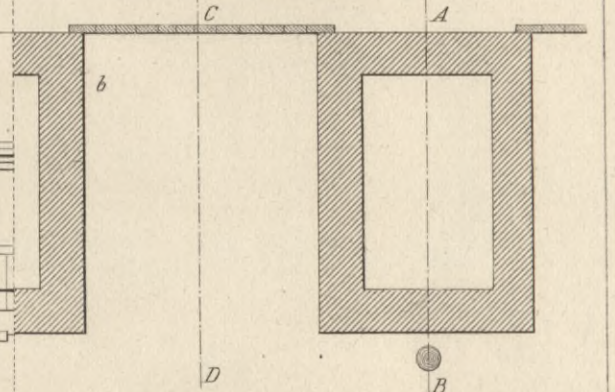
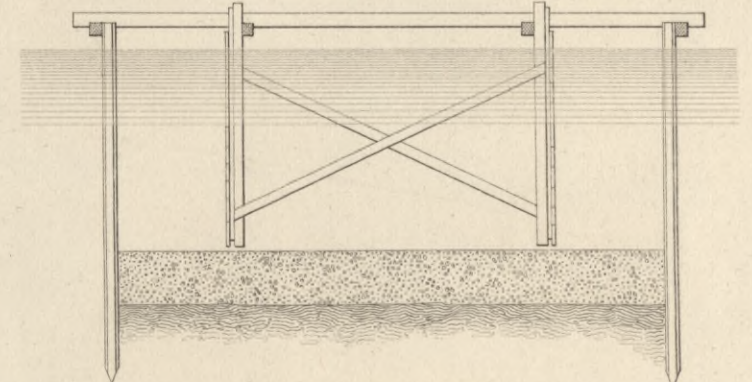
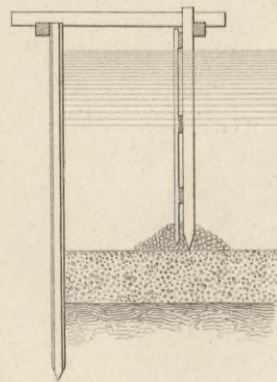

Fig. 266.

Fig. 267.



zu Fig. 264, 266 u. 267.

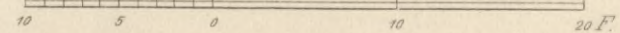

Fig. 271.

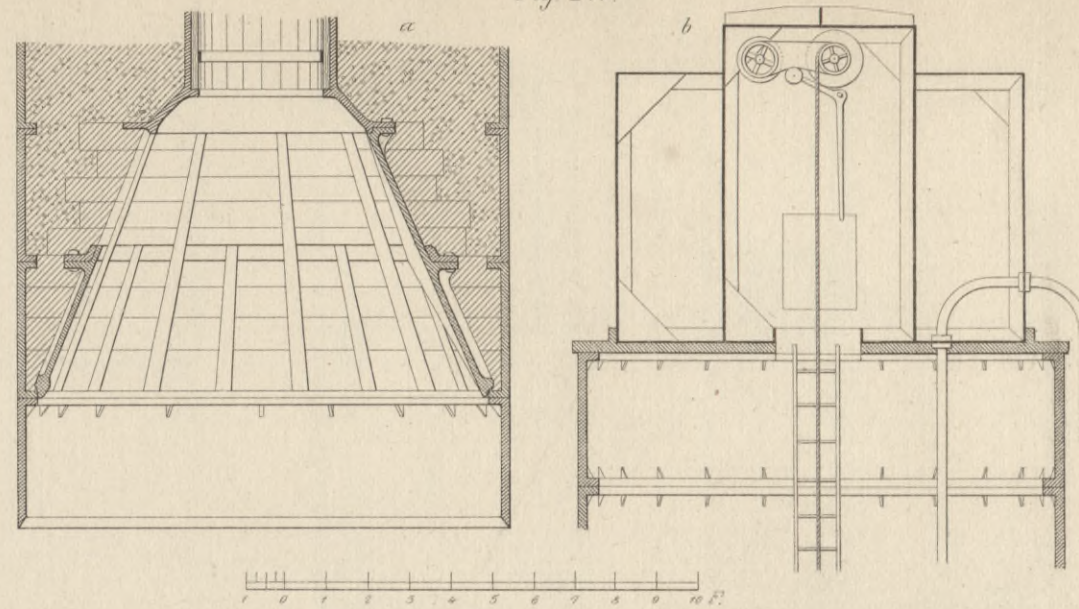

Fig. 269.

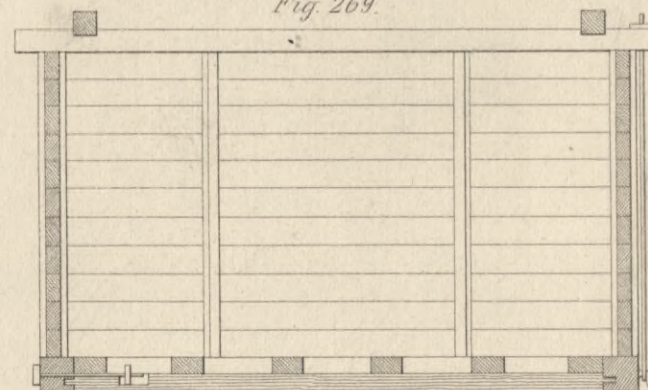

Fig. 272.

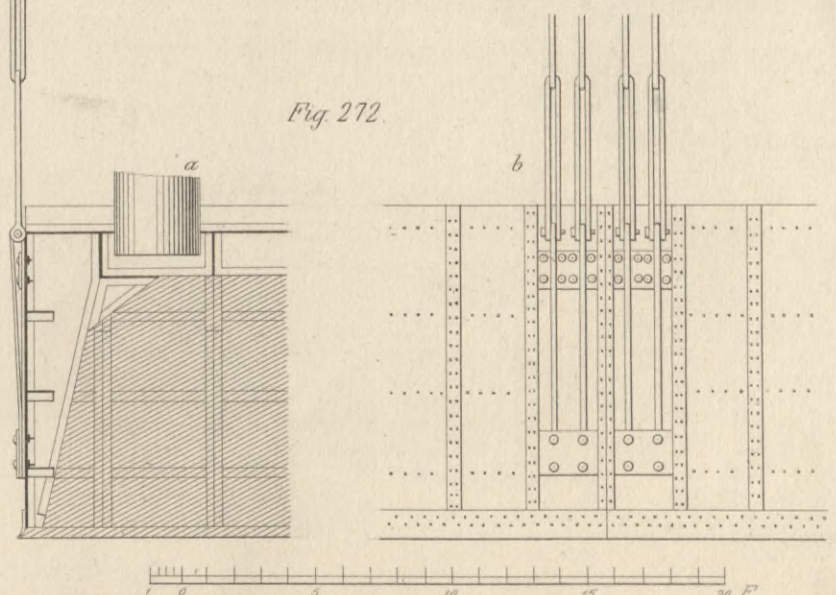
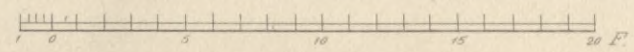
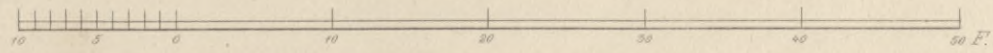
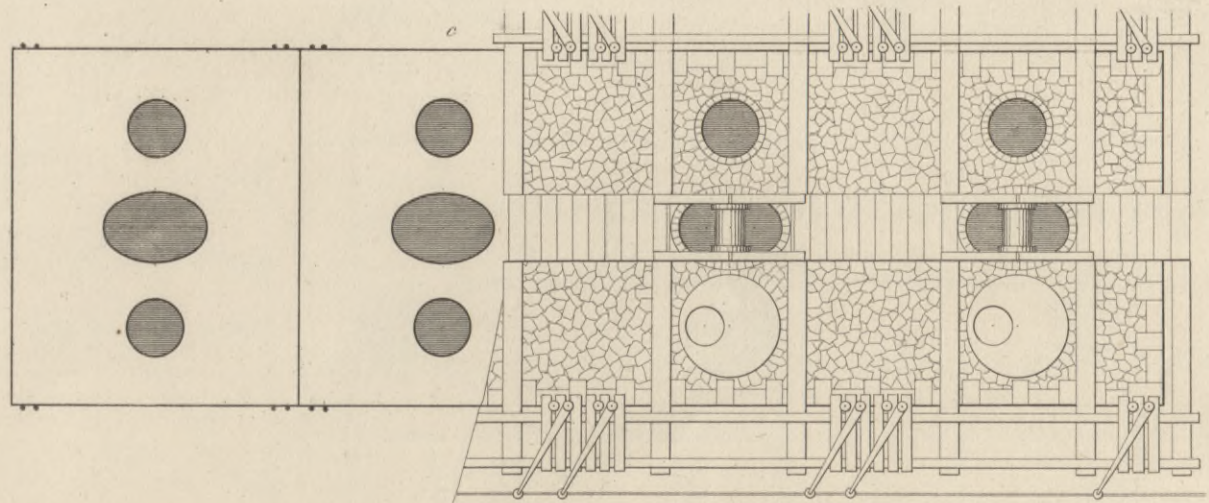
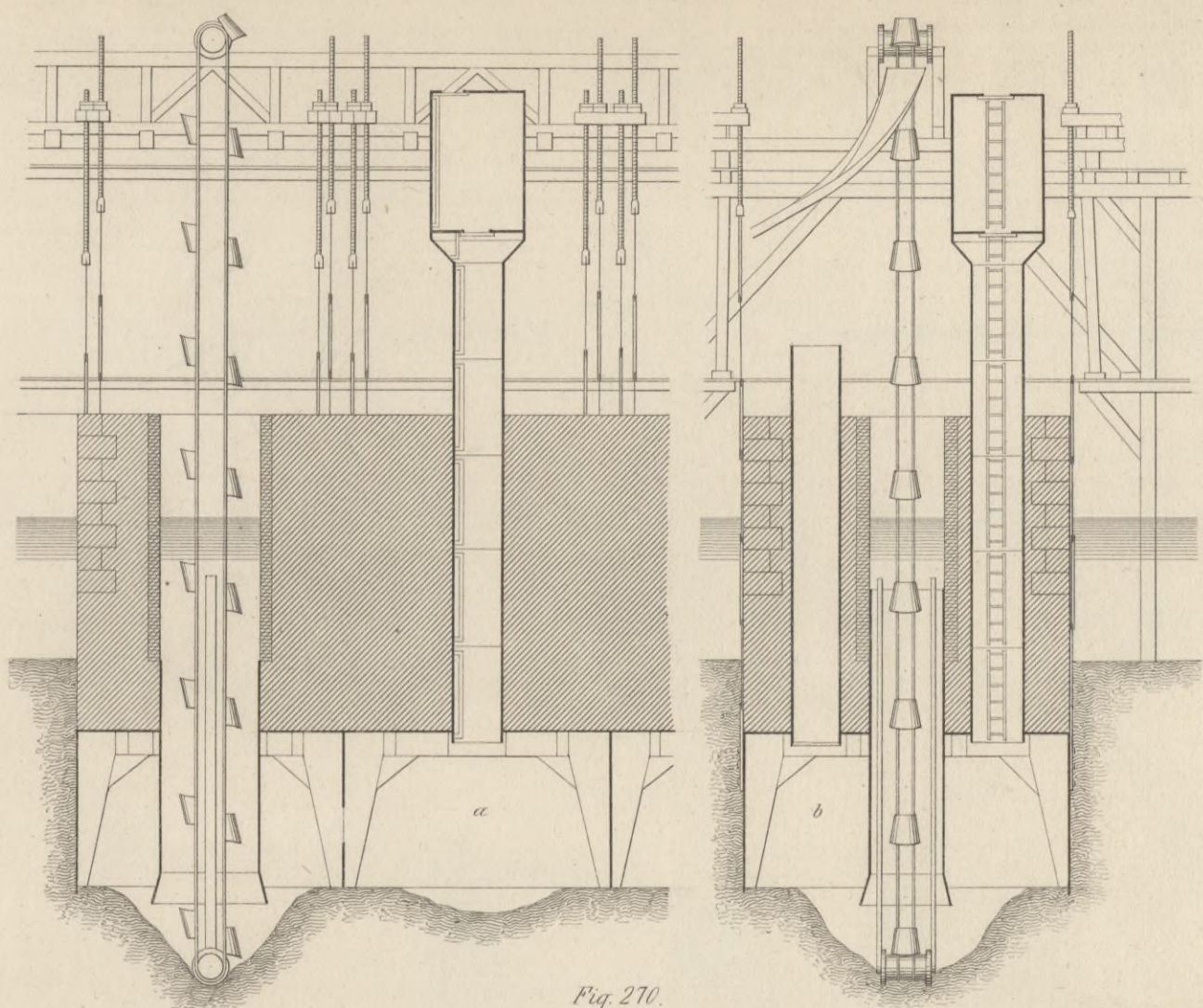

Fig. 270.



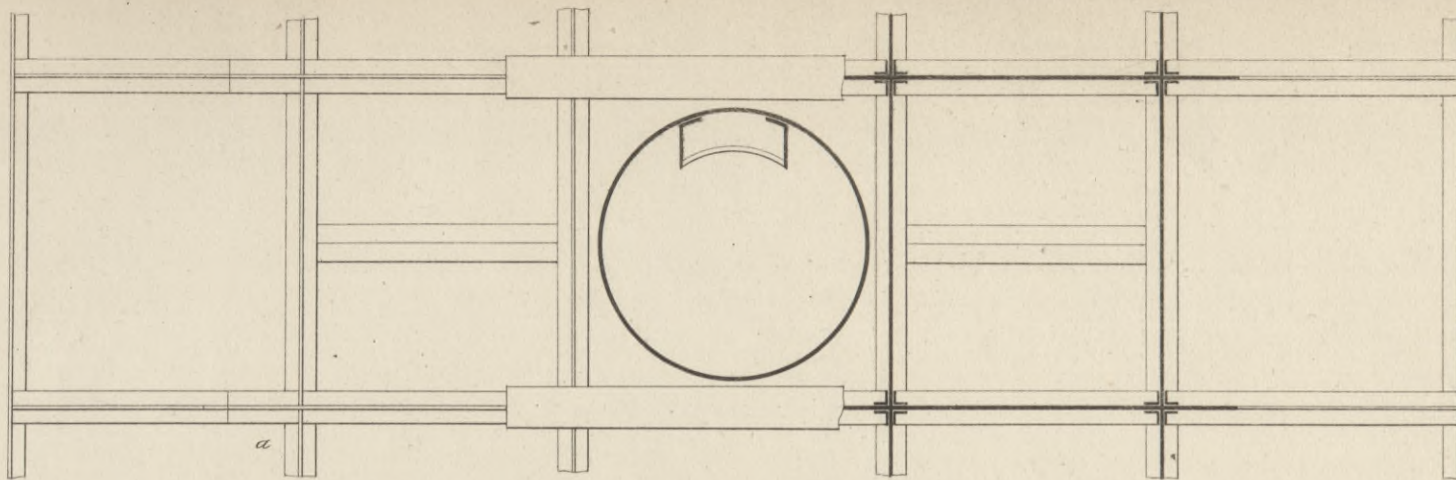

Fig. 274.

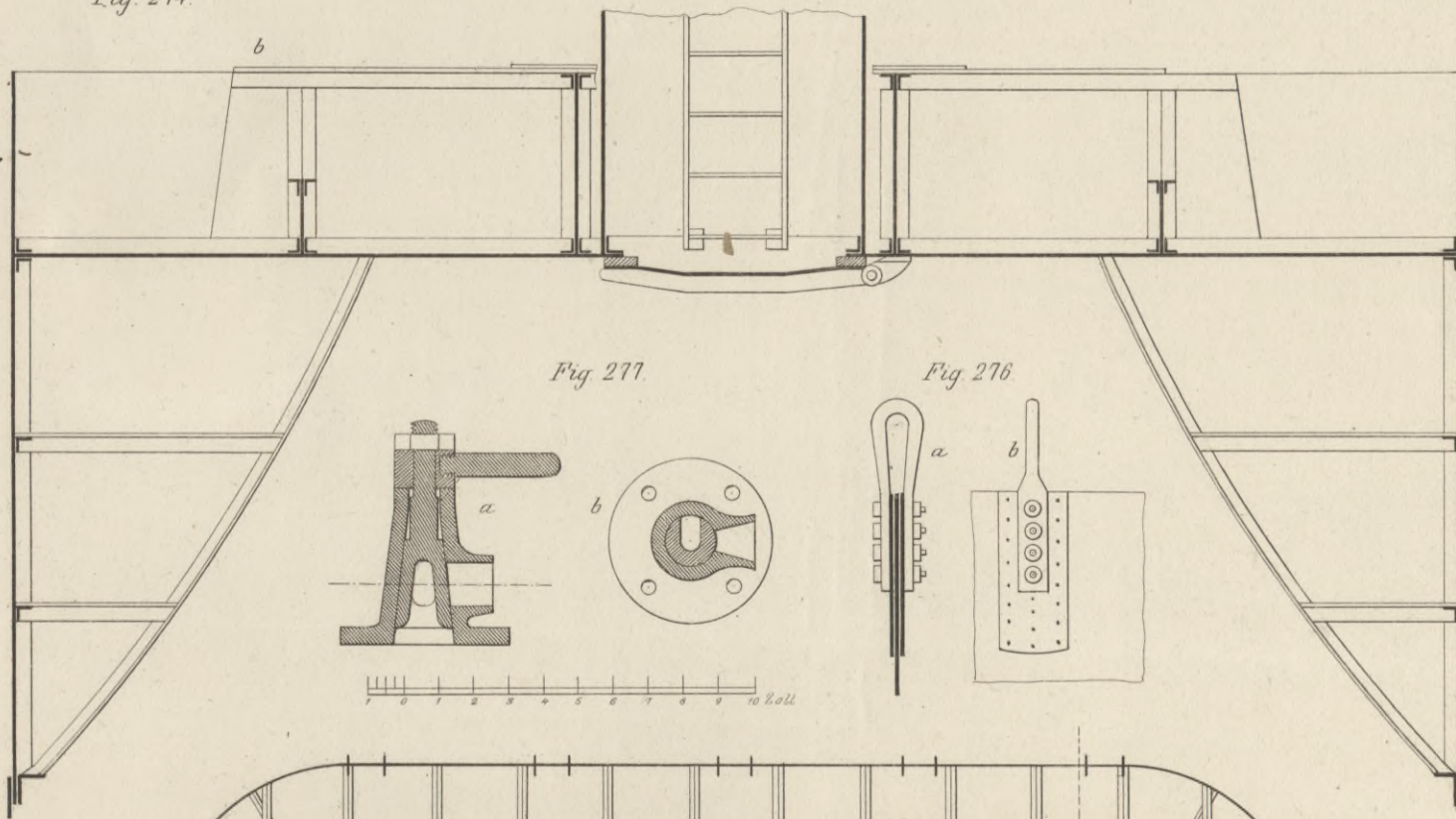

Fig. 275.

Fig. 277.

Fig. 276.

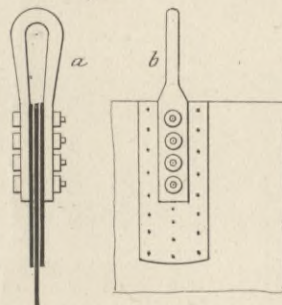
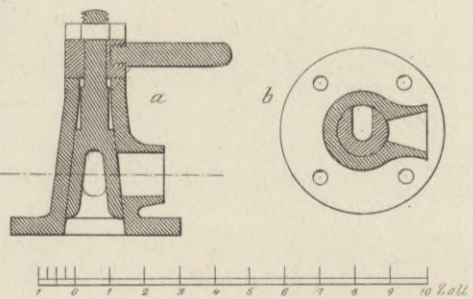
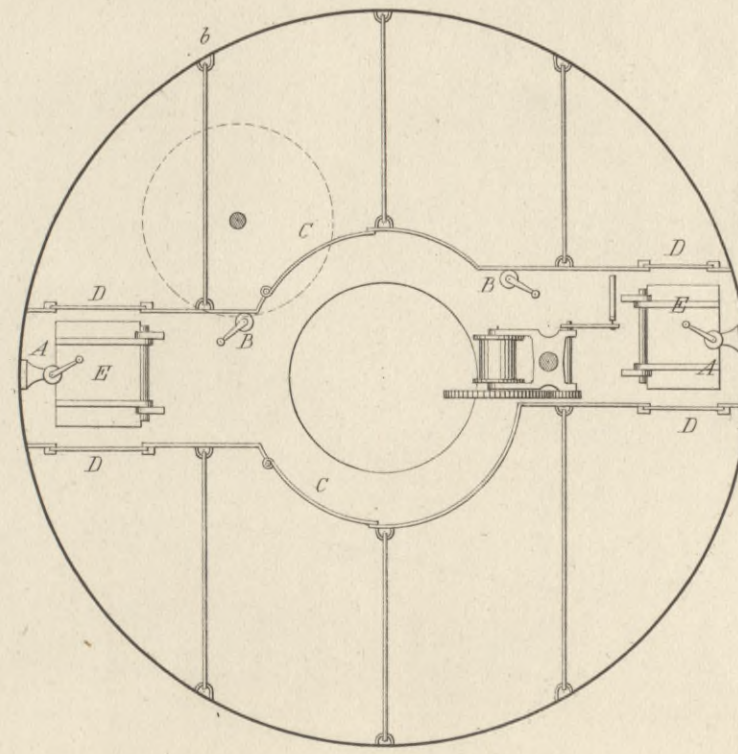
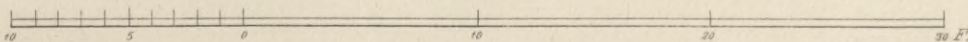
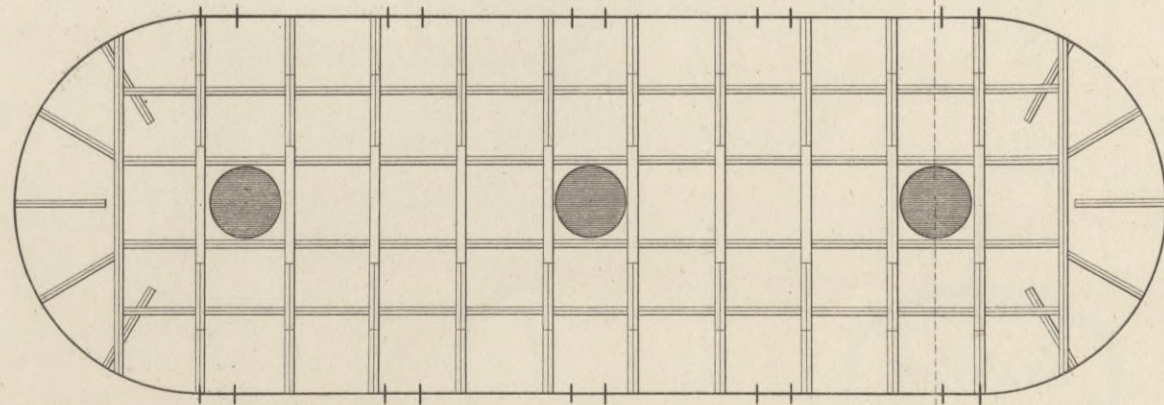
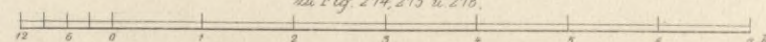

Fig. 273.



zu Fig. 274, 275 u. 276.





S. 61

POLITECHNIKA KRAKOWSKA
BIBLIOTEKA GŁÓWNA

Biblioteka Politechniki Krakowskiej



III-306401

ISBN 324 13 LX 34

Biblioteka Politechniki Krakowskiej



100000300975