

# environmental engineering

Soil Remediation.  
Laboratory Classes

Tomasz Baczyński



Cracow University  
of Technology

Kraków 2020

# **environmental engineering**

**Soil Remediation.  
Laboratory Classes**

Tomasz Baczyński

Kraków 2020

CHAIRMAN OF THE CRACOW UNIVERSITY OF TECHNOLOGY PRESS EDITORIAL BOARD

Tadeusz Tatara

CHAIRMAN OF THE DIDACTIC BOARD

Elżbieta Węclawowicz-Bilska

SERIES EDITOR

Barbara Dąbrowska

REVIEWER

Jerzy Mikosz

PROJECT COORDINATORS

Otmar Vogt

Janusz Pobożniak

PUBLISHING EDITOR

Agnieszka Filosek

PROOFREADING

Małgorzata Sikora

LANGUAGE VERIFICATION

LINGUA LAB s.c.

TYPESETTING

Anna Pawlik

COVER DESIGN

Karolina Szafran

This text was published as a part of the project 'Excellence programming – PK XXI 2.0 Cracow University of Technology development program for the years 2018-22'.

Funding from EU: 18,048,774.96 PLN

© Copyright by Cracow University of Technology

© Copyright by Tomasz Baczyński



<https://creativecommons.org/licenses/by-sa/4.0/>

eISBN 978-83-66531-59-8

Online edition

11 publisher's sheets

Wydawnictwo PK, ul. Skarżyńskiego 1, 31-866 Kraków; 12 628 37 25, fax 12 628 37 60

wydawnictwo@pk.edu.pl

www.wydawnictwo.pk.edu.pl

Correspondence address: ul. Warszawska 24, 31-155 Kraków



European Union  
European Social Fund



# Table of Contents

Part 1. Soil remediation	5
Part 2. Soil contamination standards	41
Part 3. Methods of remediation of soil and groundwater	106
Part 4. Methods of remediation of soil and groundwater: Physical methods	141
Part 5. Methods of remediation of soil and groundwater: Chemical methods	176
Part 6. Methods of remediation of soil and groundwater: Natural attenuation and bioremediation	216
Part 7. Project: prediction of risk by contaminant plume spread	257
Laboratory class 1. Basic physical and chemical properties of soil Biotests	296
Laboratory class 2. Mobility of heavy metals and their remediation	311
Laboratory class 3. Remediation by chemical oxidation: Fenton's reagent	320
Course programme	334
Literature	337

Part 1

# Soil remediation

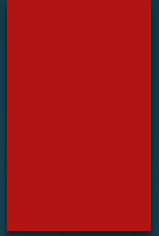

**Remediation** – treatment of soil and groundwater aiming at removal or reduction of amount of risk posing substances, their control and limitation of their spreading, so that the contaminated area ceases to endanger human health or the state of the environment, considering current and, if possible, planned future use of the area; remediation could involve self-purification, if such conduct is the most beneficial for the environment.

Environmental Protection Act, changes from 07.2014

Source: www.nrcs.usda.gov

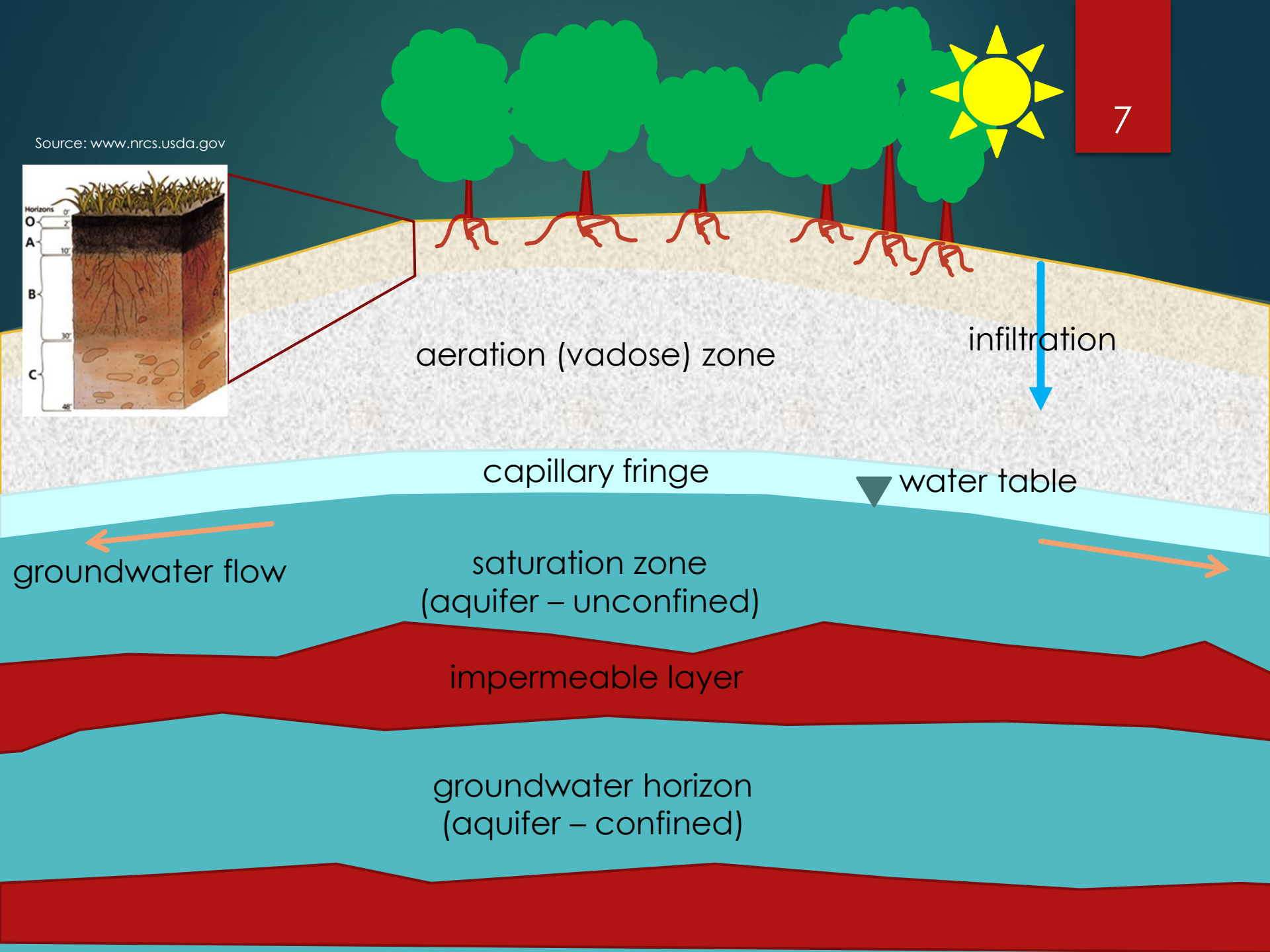
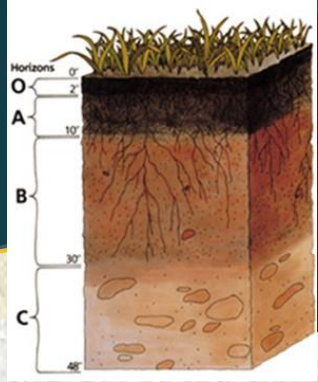

## Soil constituents (phases):

- mineral, solid
- organic
- liquid – soil water
- gaseous.

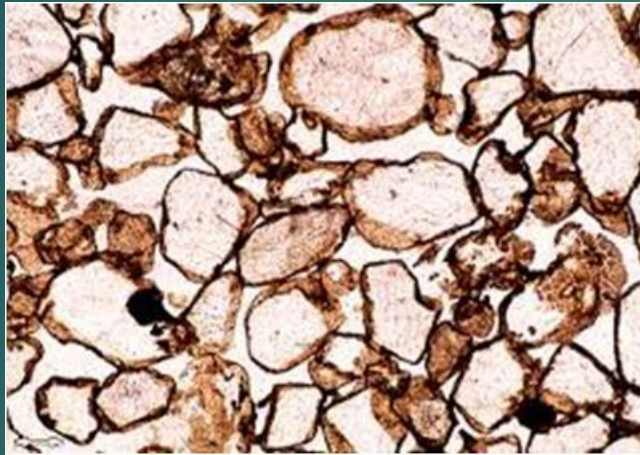



## Mineral, solid phase:

Products of parent material (bedrock) weathering (different minerals):

- boulders, cobbles > 80 mm
- pebbles, gravel > 2 mm
- 2 mm > sand > 0.05 mm
- 0.05 > silt > 0.002 mm
- clay < 0.002 mm.

Clay – the most active fraction (ion exchange, sorption, structure changes, etc.).

The share of individual fraction (composition) is a base for soil classification (texture).

Granulometric analysis – sieving.

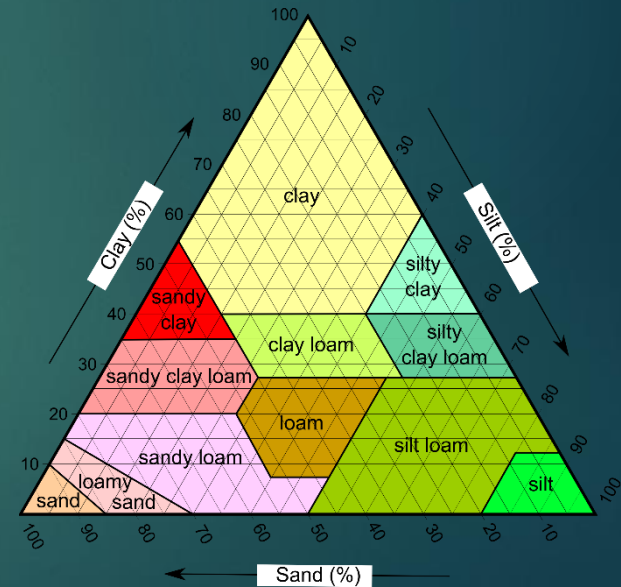

Soil types according to USDA  
Source: Mikenorton

## Organic phase:

- living organisms
- decaying organic matter, debris (different stages)
- humus
- “black carbon”.

Concentration in soil: from tenths to tens of %; most often a few %.

The most active component of soil: sorption, ion exchange, etc.

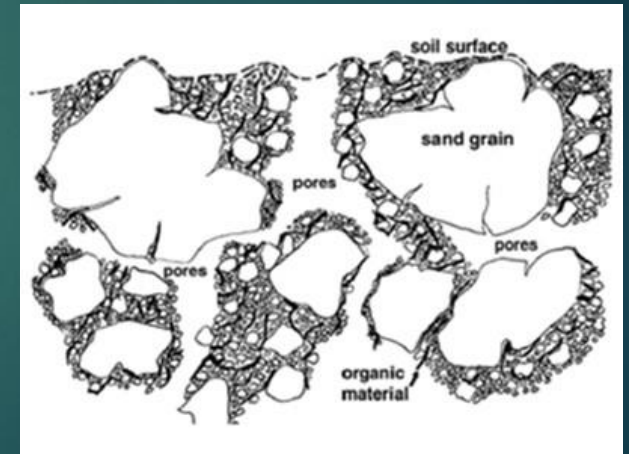

## Living biota:

- macrofauna and mezofauna: insects, vertebrates; nematodes, arthropods, annelids, mollusca...
- microfauna: protozoa (amoebas, ciliates, flagellates...)
- microflora: algae, fungi, bacteria (actinobacteria) – even  $> 1 \text{ kg/m}^2$ .

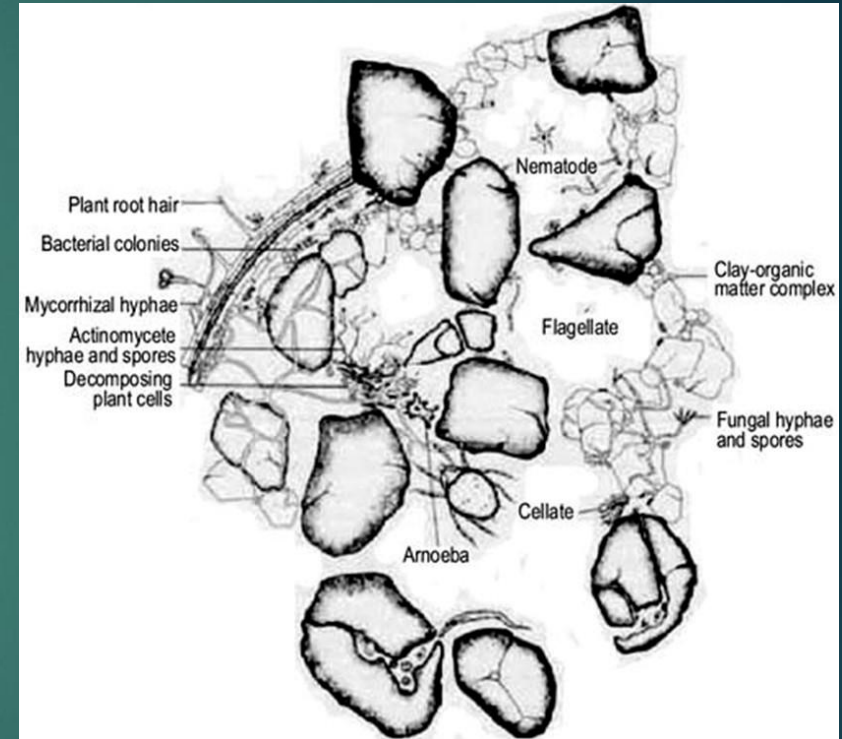

Source: Frey, 2007

## Dead organic matter:

- organic compounds free of nitrogen (carbohydrates, phenols, quinones...)
- nitrogen compounds (proteins, aminoacids, chitin...)
- lipids and their degradation products (alcohols, glycerol...).

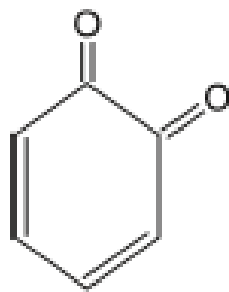

o-Quinone

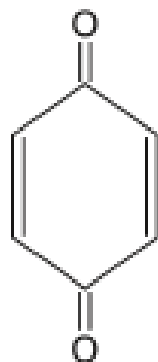

Benzoquinone

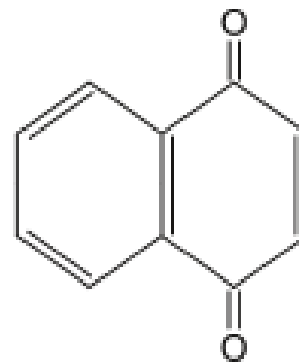

Naphthaquinone

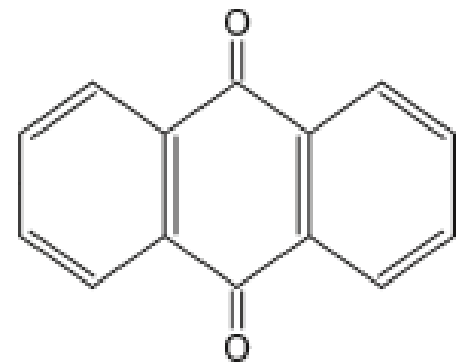

Anthraquinone

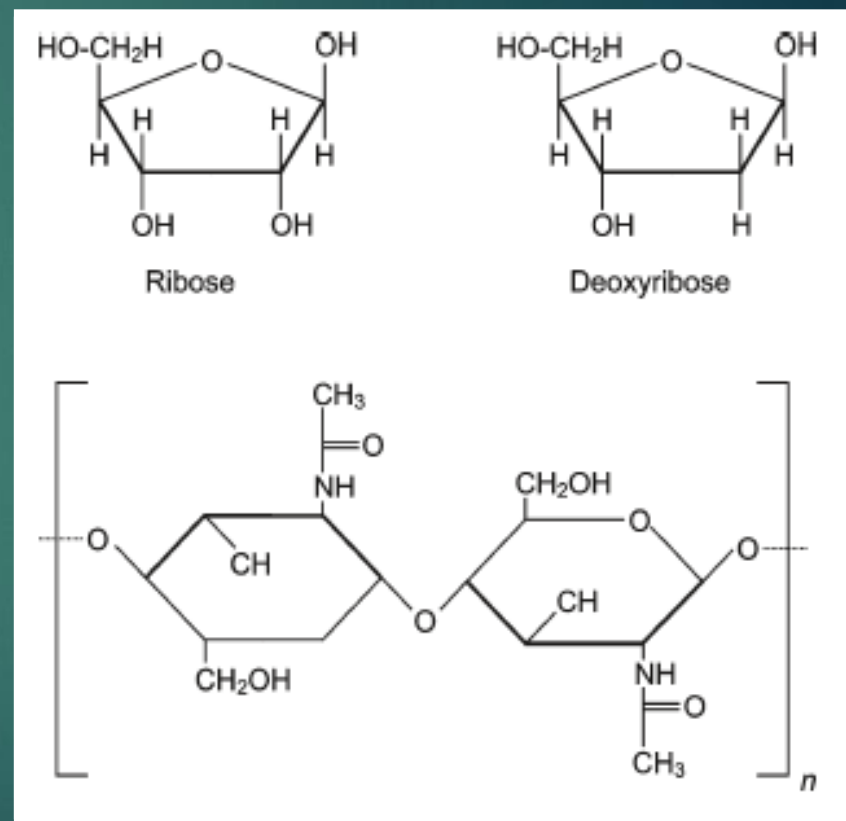
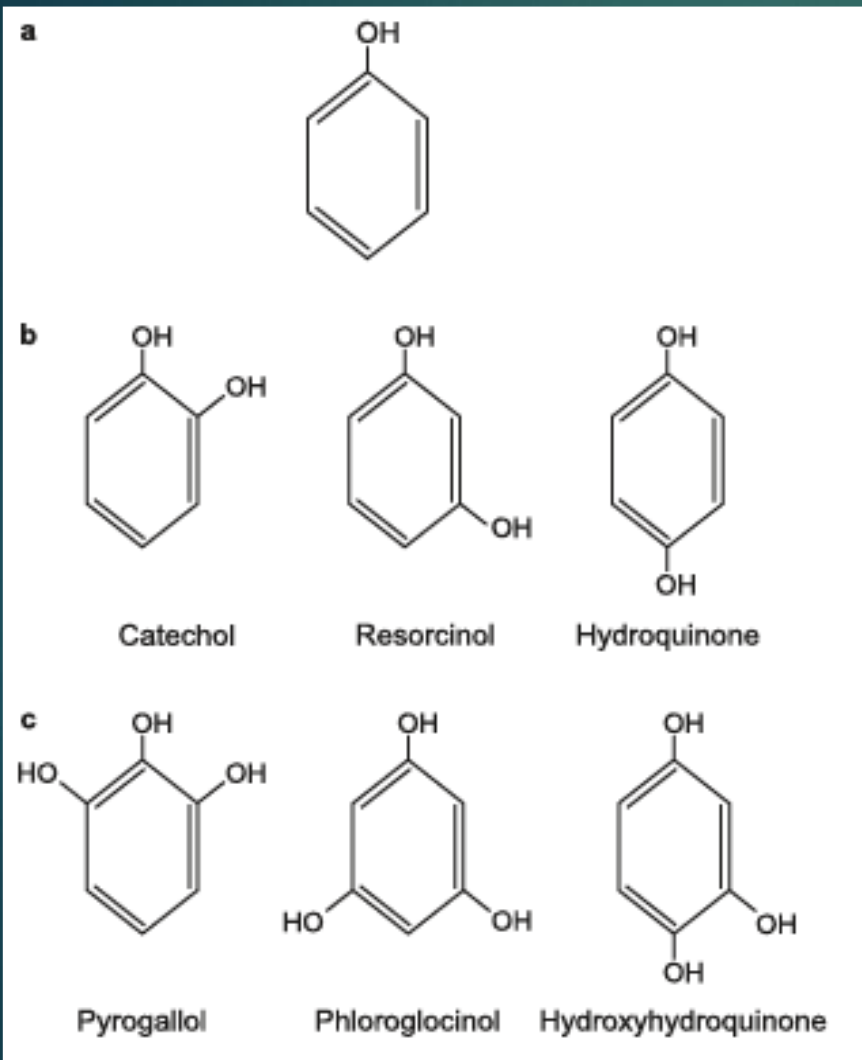

Humus: stable product of organic matter transformations, of complex structure; mixture of amorphous and colloidal compounds.

Following fractions can be distinguished:

- humic acids – soluble at  $\text{pH} > 2$
- fulvic acids – remains in solution on acidification of the alkaline extract
- humins – insoluble, regardless of  $\text{pH}$ .

Strong properties: ion-exchange, chelating (metals), sorption, binding organic contaminants, holding water...

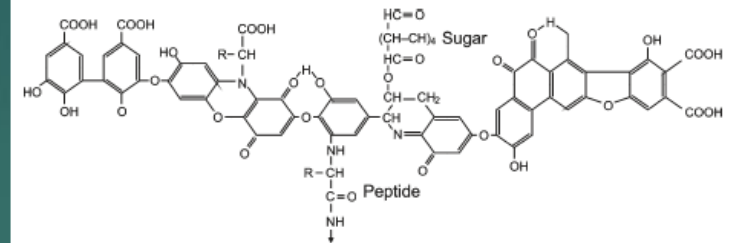

Fig. 2.33 A structural model of humic acid (after Stevenson 1994)

Fig. 2.38 A model for the structure of fulvic acid (according to J. Buffe 1988)

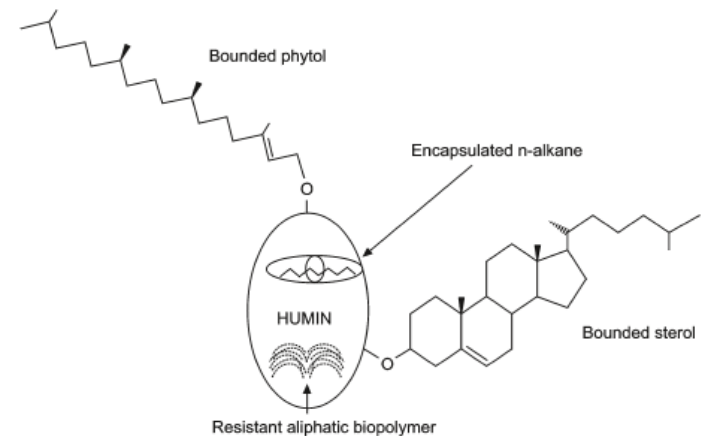
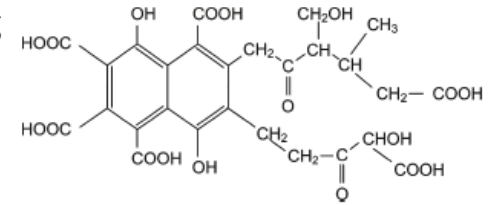

Fig. 2.39 The tentative model of humin suggested by Lichtfouse (1999)

## Water – soil solution:

- \* dissolved gases (mainly carbon dioxide, also hydrogen sulphide, methane, sometimes oxygen...)
- \* salts (anions and cations) – buffering properties pH ((bi)carbonates)
- \* organic compounds (dissolved organic matter).

Main factor for contaminants transport; also transporting substrates necessary for their degradation (oxygen, nitrates, organic compounds, nutrients...).

Soil air: typically 78% nitrogen, 15–20% oxygen, 1–5% carbon dioxide, water vapour; sometimes hydrogen sulphide, methane, etc.

Transport of pollutants in vapour form; source of oxygen for biodegradation of contaminants.

## Most important soil properties, among others:

- soil pH (environmental conditions)
- hydraulic conductivity, porosity (effective) – potential for pollution transport
- organic fraction content – contaminant transport, and its binding, sorption.

	$K_h$ m/d	$\Phi_e$
Gravel	200–2,000	0.15–0.25
Sand	10–300	0.20–0.35
Silt	0.01–10	0.30–0.45
Clay	$10^{-5}$ –1	0.30–0.65
Peat	$10^{-5}$ –1	0.60–0.90



## Most common soil pollutants:

- ▶ metals, metalloids – as salts and other compounds
- ▶ aliphatic and aromatic hydrocarbons (petroleum products)
- ▶ organic solvents, mainly chlorinated
- ▶ polycyclic aromatic hydrocarbons (PAHs)
- ▶ pesticides.

## Less common:

- ❑ explosives
- ❑ radionuclides
- ❑ pharmaceuticals and personal care products (PPCPs)
- ❑ polibrominated diphenyl ethers (PBDEs)
- ❑ components of rocket fuels (perchlorates...)
- ❑ cyclic ethers
- ❑ and many others...

## Metals and metallic compounds:

Naturally occurring in the Earth's crust; contamination mainly resulted from industrial activity.

Lead (Pb), Cadmium (Cd), Mercury (Hg), Chromium (Cr), Nickel (Ni), Zinc (Zn), Arsenium (As) and others...

In the ground they are mainly transported by (ground)water as dissolved salts. They can interact with soil matrix by different mechanisms, such as: adsorption, diffusion, ion exchange, complexation etc.

Mobility, and also toxicity, depends on speciation (ion oxidation state), e.g.:

- $\text{Cr}^{+6}$  is more toxic and soluble (thus mobile) than  $\text{Cr}^{+3}$
- $\text{As}^{+3}$  is more soluble (thus mobile) than  $\text{As}^{+5}$ .

Generally, metals are more mobile in acid conditions (low pH).

Metals can occur in organic compounds, e.g. methylmercury, tributyltin – part of such chemicals are more toxic than inorganic compounds of the same metal.

## Aliphatic and aromatic hydrocarbons:

Petroleum products – products of crude oil (petroleum) processing (different fractions, e.g. jet fuel (kerosene), gasoline, diesel oil...).

Mixtures of many compounds, e.g. more than 300 in jet fuel.

Gasoline: mainly isopentane, p-ksylene, n-propylbenzene, 2,3-dimethylbutane, n-butane, n-pentane, toluene (total >50%).

The most important compound, from the ecotoxicological point of view: benzene (partly soluble, toxic and cancerogenic).

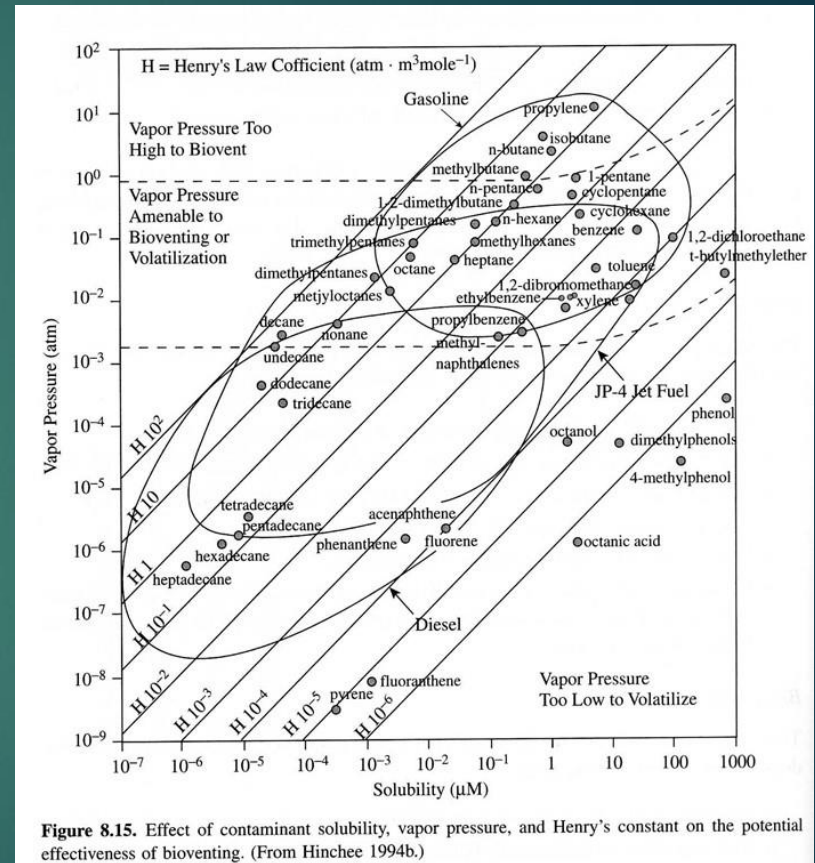

Hydrocarbons are generally poorly soluble in water, so in the ground they tend to form a layer of free product floating on the water table (LNAPL – light non-aqueous phase liquids).

Some of them (e.g. short-chain alkanes) are volatile and readily enter into gas phase (volatilisation).

Some are more or less water-soluble: BTEX (benzene, toluene, xylene, ethylbenzene) – comprise >60% of all water-soluble hydrocarbons from gasoline.

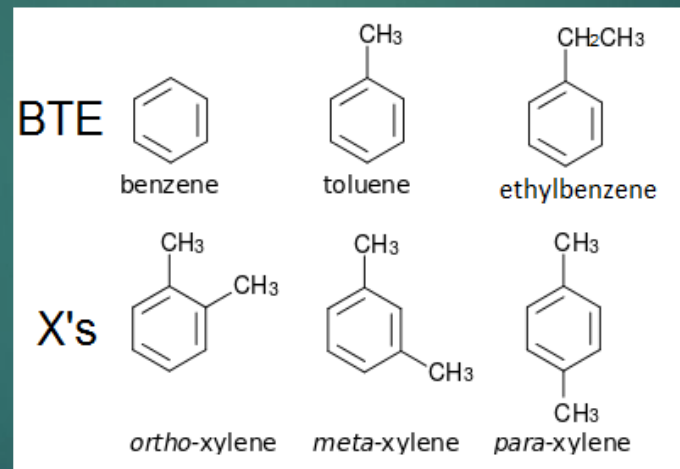

Source: <http://www.gcesystems.com/what-is-btex/>

Sum of hydrocarbons is also included in analytical measurements (e.g. C6-C12 represents gasoline fraction, C12-C35 represents oils) (TPH – total petroleum hydrocarbons).

## Chlorinated solvents:

Large group; commonly used in industry as solvents and degreasers.

Most often occurring are:

- tetrachloroethylene and derivatives:
- tri-, dichloroethylene, vinyl chloride
- trichloroethane
- chlorinated methanes: carbon tetrachloride, dichloromethane, chloroform.

Toxic properties, carcinogenic (considerable risk)...

Poorly soluble in water, immiscible (important for possible transport!); some are more dense than water (DNAPL dense non-aqueous phase liquids).

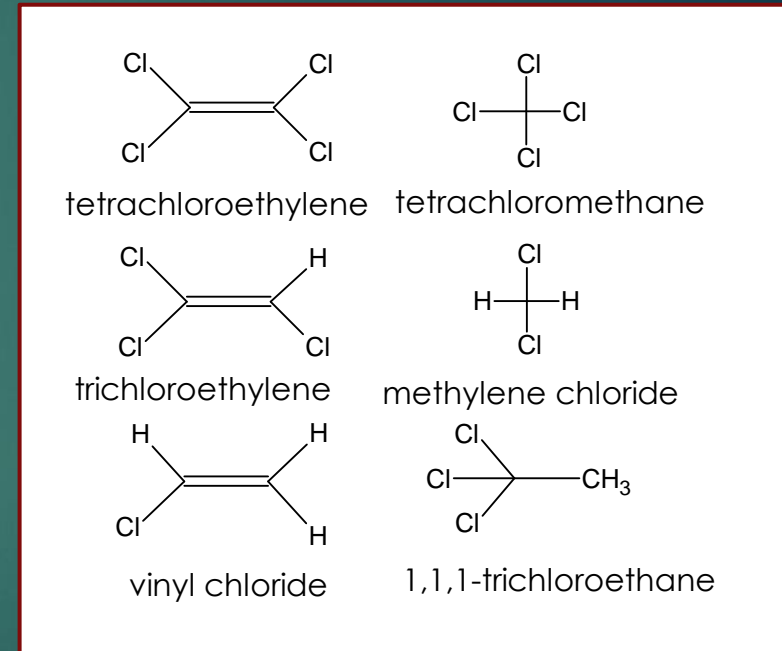

## Polycyclic aromatic hydrocarbons (PAHs):

Generated during coal processing and combustion (also other fuels).

Main component of creosote, present in tars etc. Some are present in petroleum products.

Occurring in areas surrounding factories processing coal and crude oil.

Some have cancerogenic properties (notably benzo(a)pyrene).

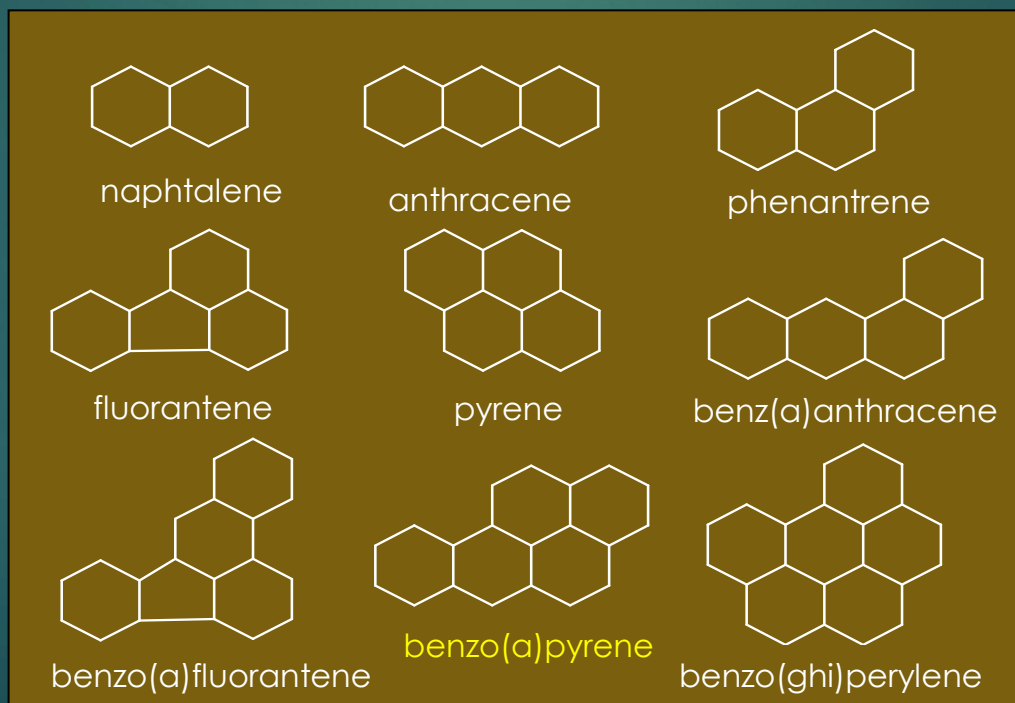

## Pesticides:

Very large group of compounds, used as active ingredients in plant protection products.

Division concerning activity (target):

- insecticides
- herbicides
- fungicides
- ...

Division concerning chemical structure  
— organochlorine

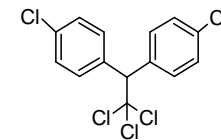

**DDT**

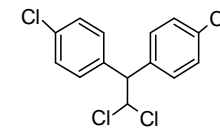

**DDD**

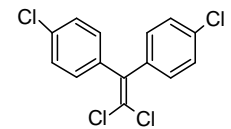

**DDE**

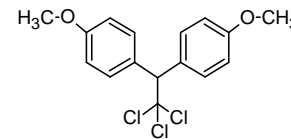

**METHOXYCHLOR**

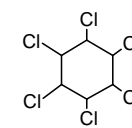

**LINDANE**

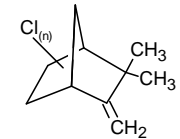

**TOXAPHENE**

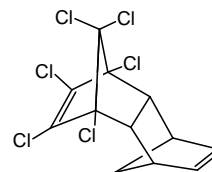

**ALDRIN**

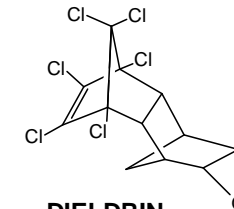

**DIELDRIN**

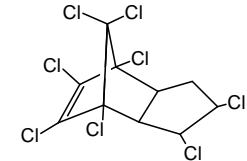

**CHLORDANE**

— organophosphorus

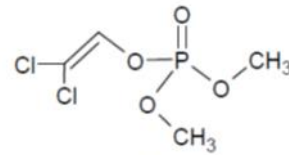

dichlorfos

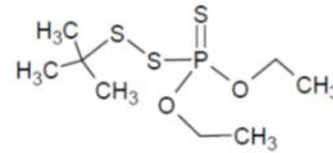

terbufos

— carbamates

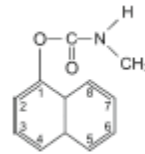

Carbaryl

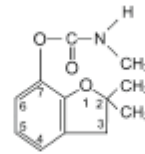

Carbofuran

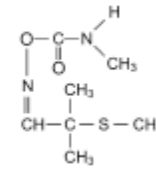

Aldicarb

— phenoxy acids

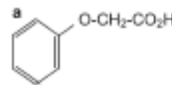

Phenoxy-acetic acid

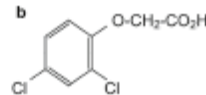

2,4-dichlorophenoxy-acetic acid

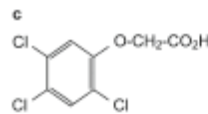

2,4,5-trichlorophenoxy-acetic acid

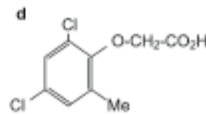

2-methyl-4,6-dichloro-phenoxyacetic acid

— triazines

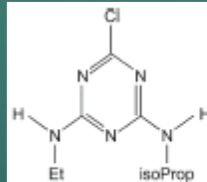

b Atrazine

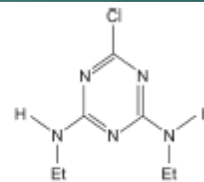

c Simazine

— dinitrophenols and others...

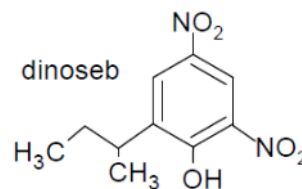



## Fate of contaminants in soil and groundwater environment:

Behaviour and interaction of contaminant with soil comprised of a number of physical, chemical and biological processes, taking place in all 3 phases constituting this environment: solid, liquid and gaseous.

One can distinguish:

- transport: infiltration, diffusion and movement by groundwater flow (dispersion, advection)
- volatilization
- retention (adsorption, sorption, precipitation, trapping)
- alteration of contaminant (transformation, degradation – chemical and biological)

## Contamination

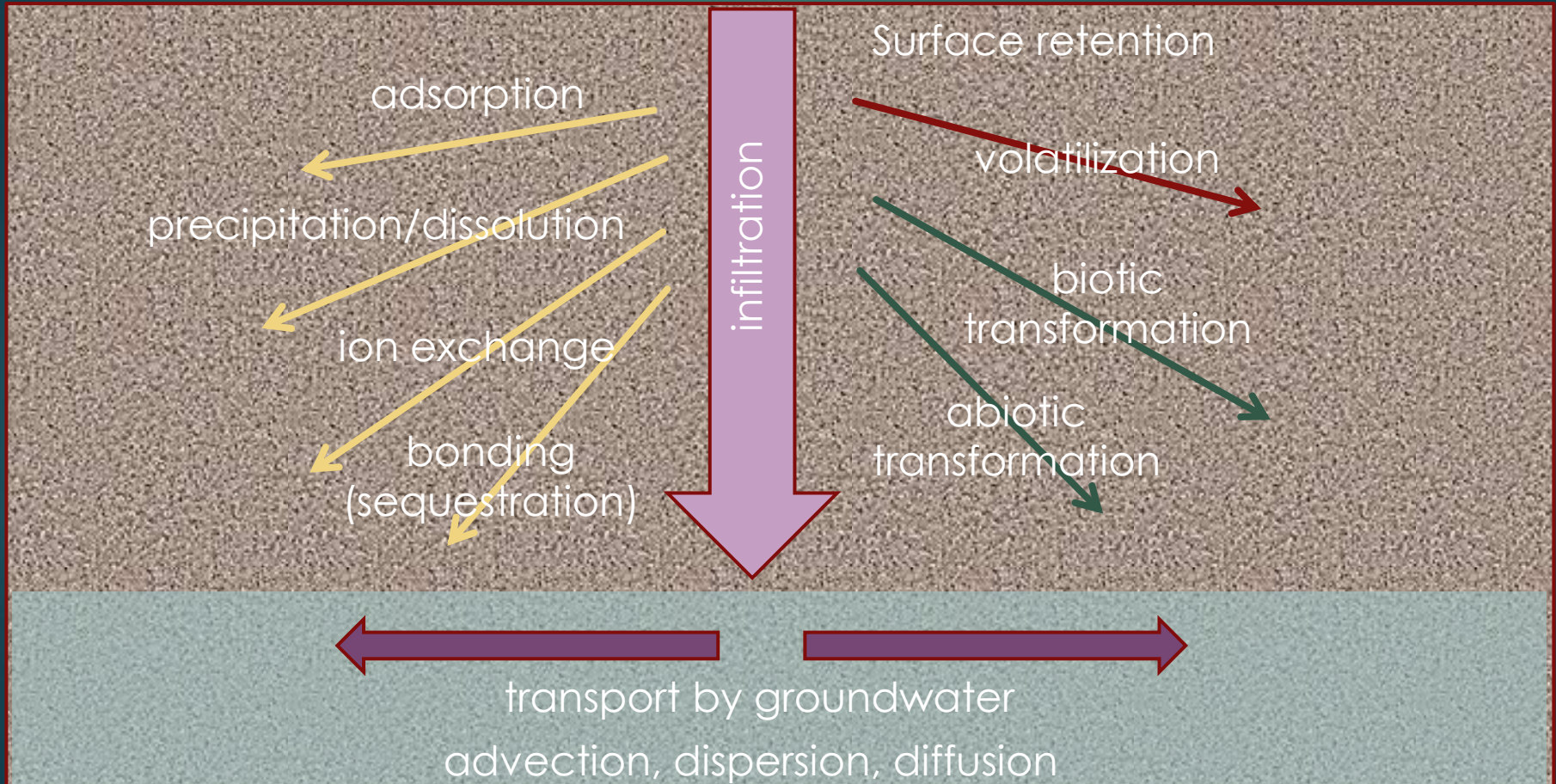

## Properties of contaminant (chemical)

The most important for behaviour are:

- vapour pressure
- water solubility
- susceptibility to sorption:  $K_{OC}$

As for remediation, important parameters are also:

- susceptibility for (bio)degradation
- toxicity

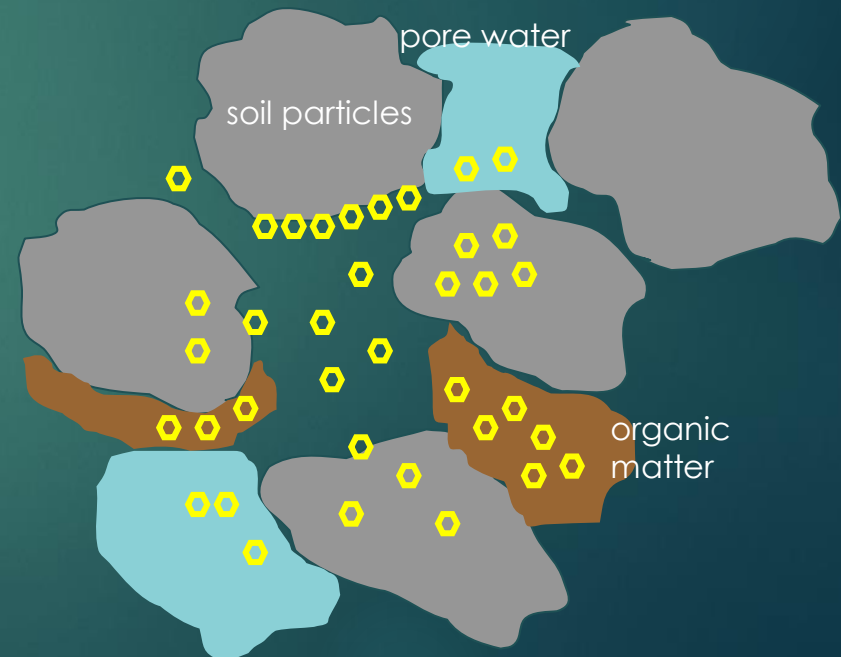

	Vapour pressure mm Hg (25°C)	Solubility mg/L (25°C)	log K <sub>oc</sub>	Degradability
dichloromethane	455	13000	0.94	+/-
chloroform	198	9300	1.64	+/-
benzene	95.2	1800	1.92	+
chlorobenzene	11.8	502	1.68	+
pentachlorobenzene	3.0*10 <sup>-3</sup>	0.135	6.3	-
benzo(a)pirene	5.6*10 <sup>-9</sup>	0.0038	5.6–6.29	-

Source: Alvarez, Illman, 2006

# Types of soil contaminants – division concerning properties and behaviour

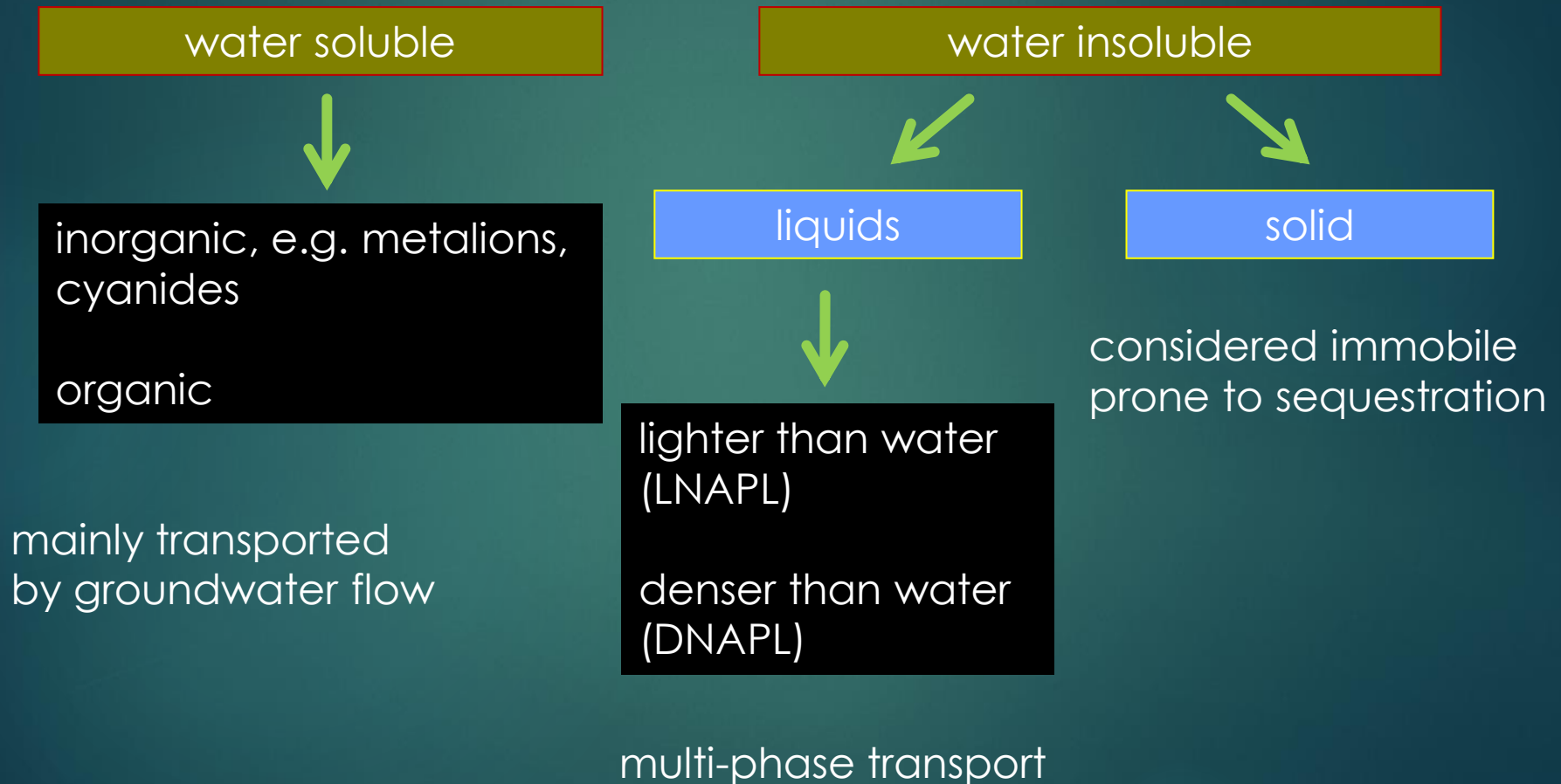

# LNAPL

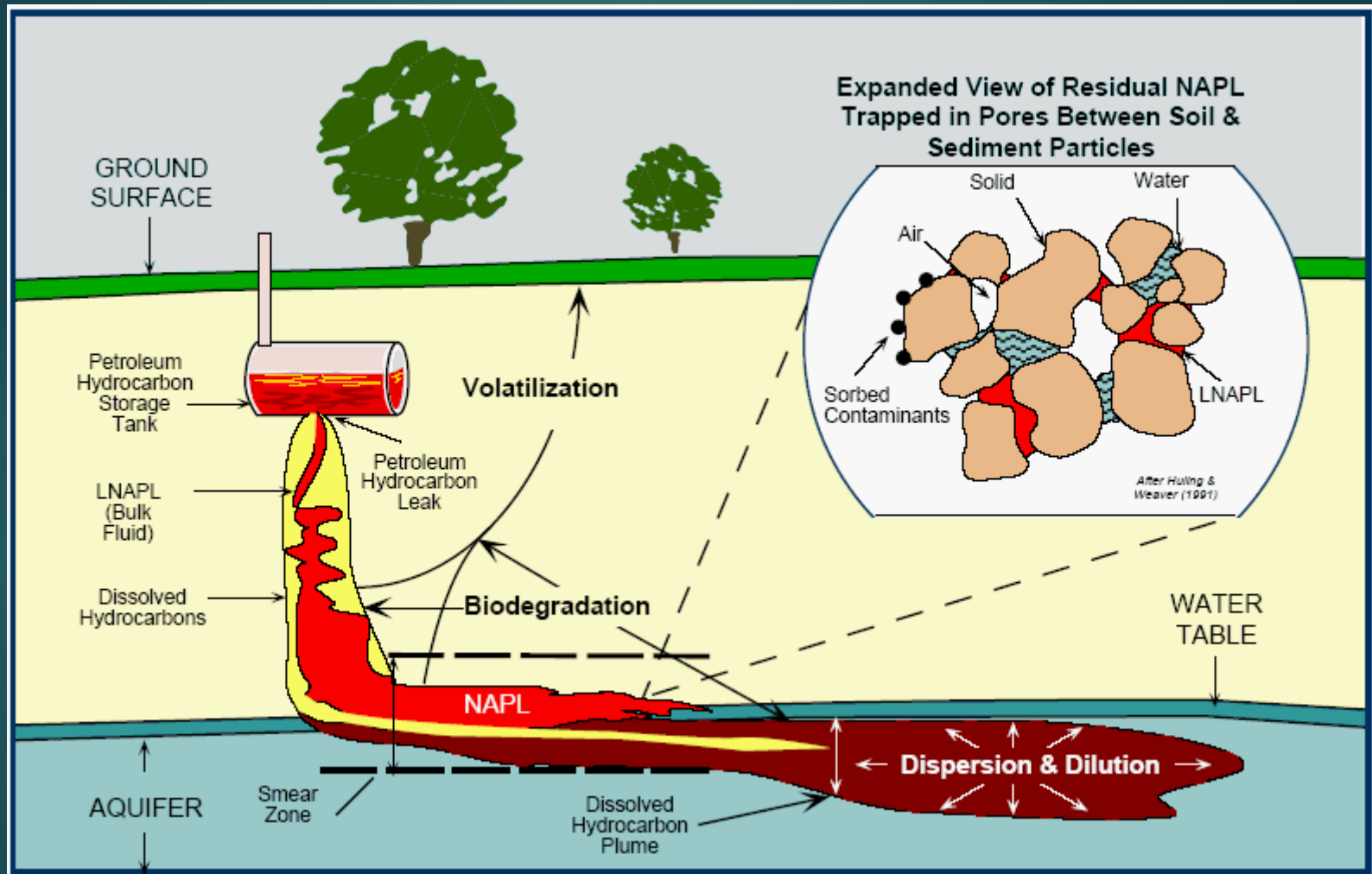

# DNAPL

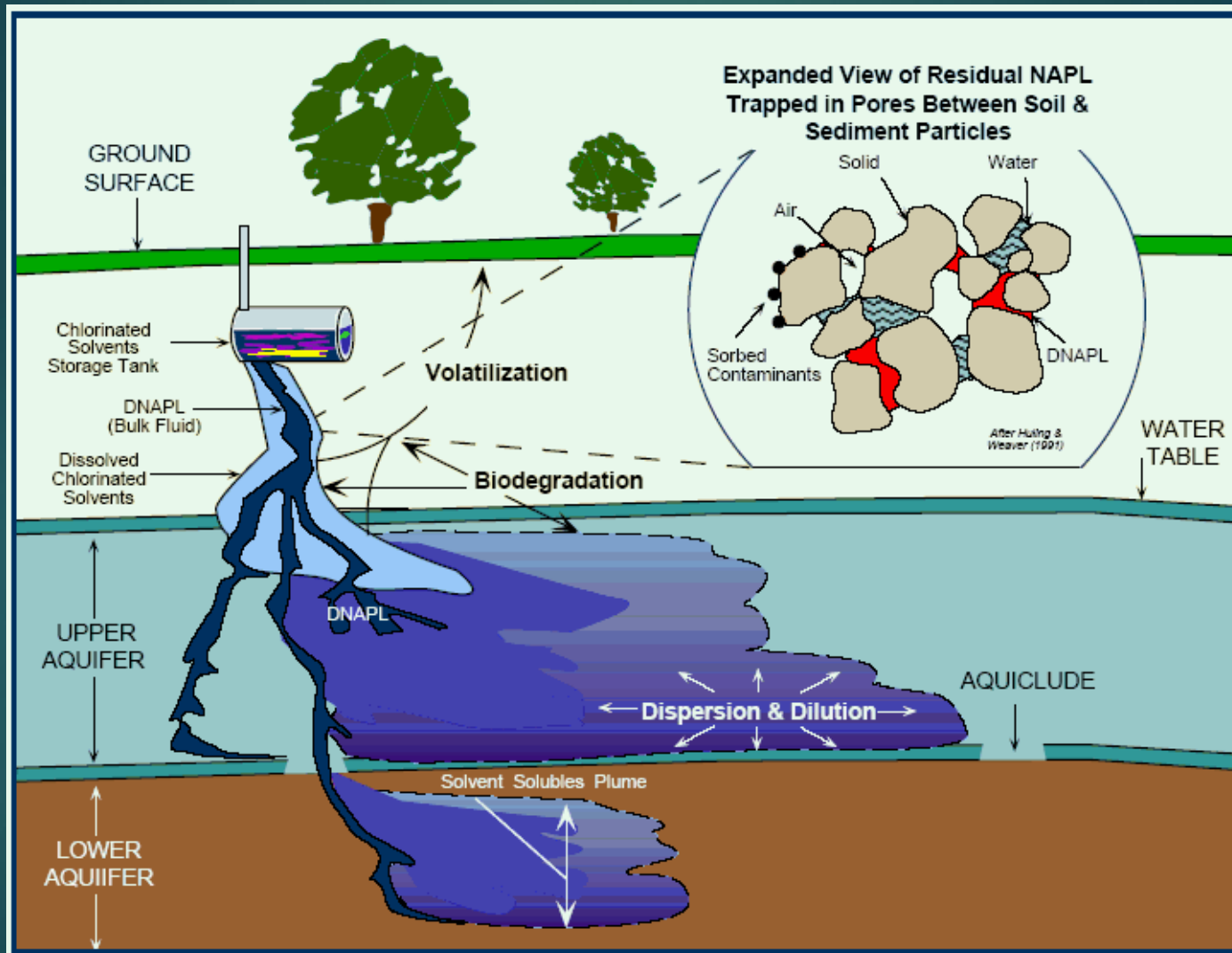

Bioavailability – e.g. ability of the active substance to enter the living organism (crossing the cell membrane).

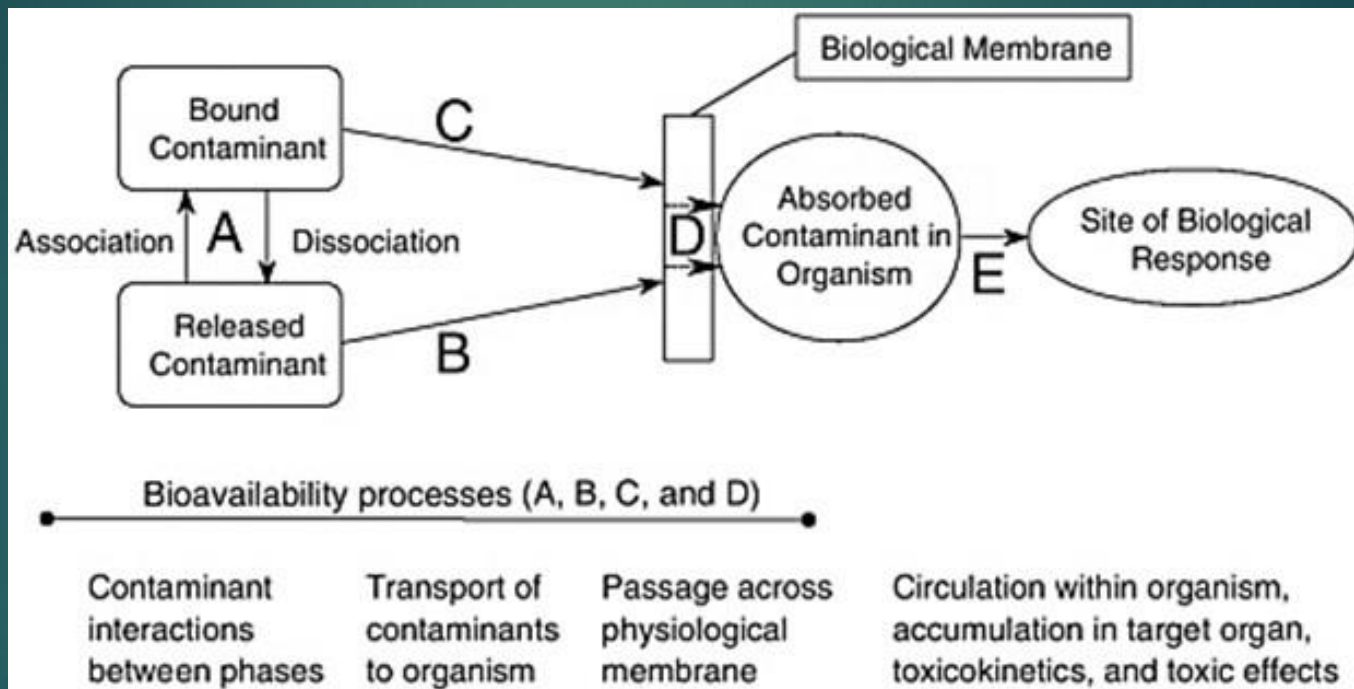



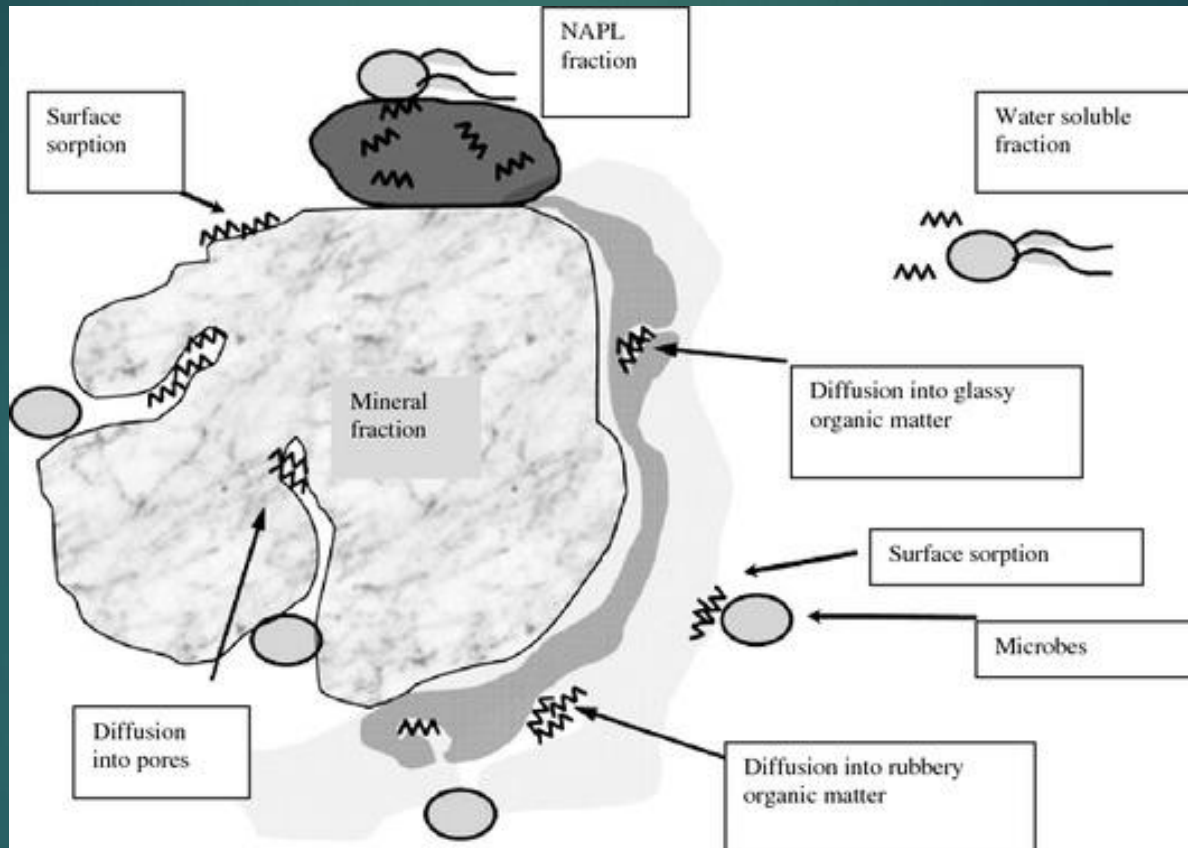

Source: Stroud, Paton, Semple, 2007

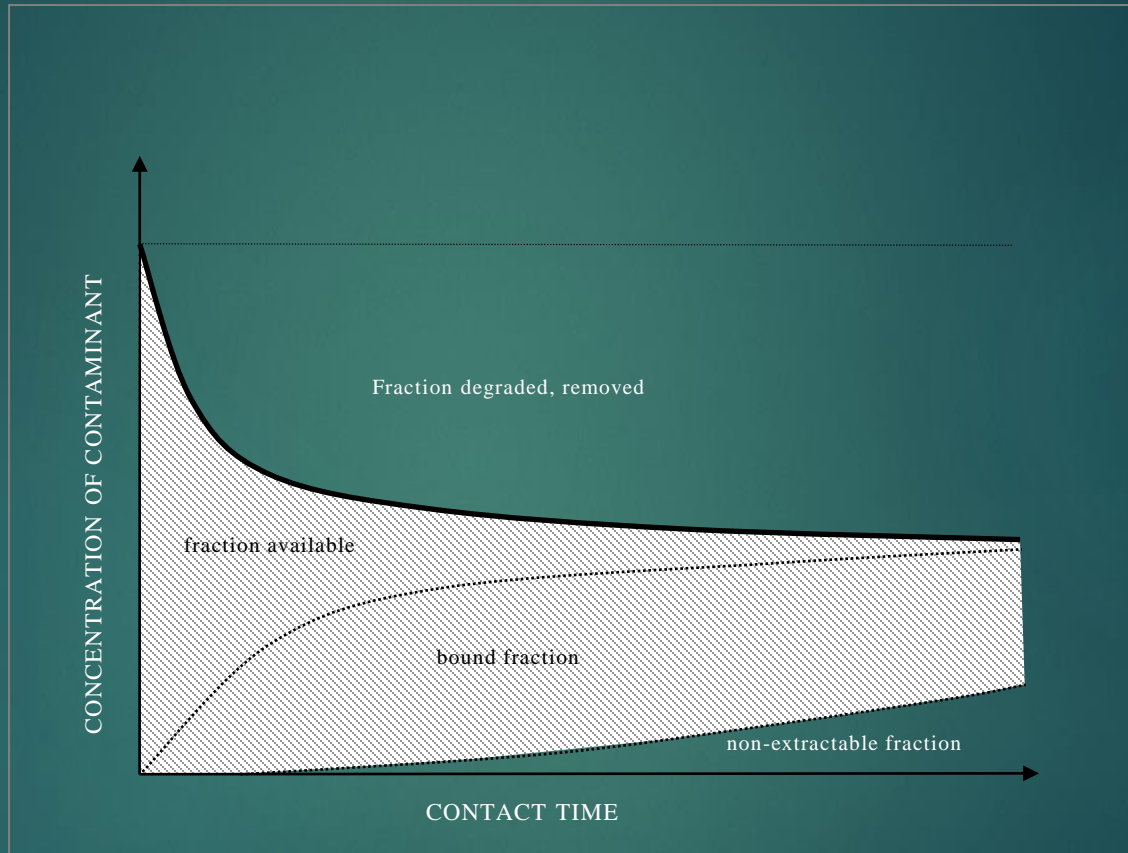

Source: Semple, Morris, Paton, 2003

less desorbable  
less (bio)degradable  
less toxic

## Cas study: Chemical factory in Tarnowskie Góry – “the biggest ecological bomb in the Silesian voivodship area”

### Industrial activity:

- a number of changes of production profile
- from the 19<sup>th</sup> century: mining of silver, zinc and lead ores; iron industry; production of paper and chemicals
- from 1921: production of paints (dyes) and many inorganic chemicals (salts)
- 1995: production ceases; 1997: factory closure.



### Pollution sources:

- hazardous waste stored in the factory area: 9 unsecured landfills were found – with area of 34 ha and 1,2 mln m<sup>3</sup> of waste;
- leaching to groundwater i.a.: boron, barium, strontium, arsene, copper, zinc
- from the year 2002: gradual disposal of dump sites and transfer of wastes and contaminated soil to new, secure landfill – “tomb” (not completed).



© Agencja Gazeta

## (Geo)hydrological conditions:

- catchment of Stoła river (Mała Panew-Odra), through streams (Pniowiec)
- to 150–250 m depth: Triassic sediments (cracked dolomite, limestone and marl)
- to 50 m depth: Jurassic sediments (clayey and silty)
- covered by Quaternary sediments (gravels, sands and clays)
- from 1 to 3 groundwater aquifers:
  - ✓ 1–2 in Triassic layers (area between main groundwater reservoirs; water resources for Częstochowa and Tarnowskie Góry regions)
  - ✓ upper, Quaternary aquifer 1–12 m below surface.

Source: maps.google.com

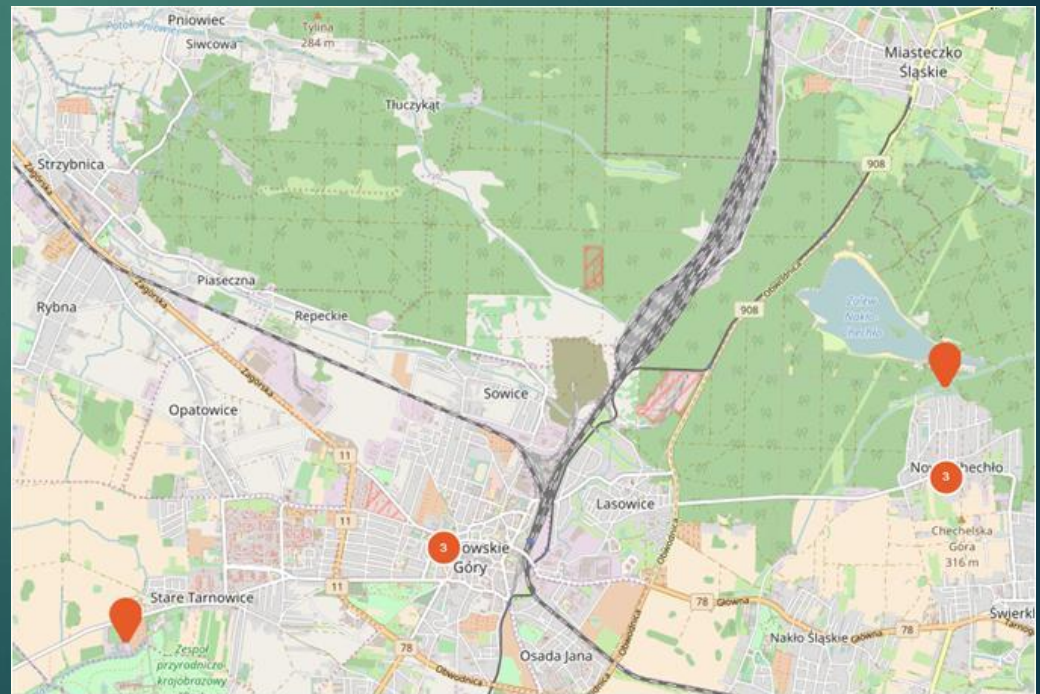
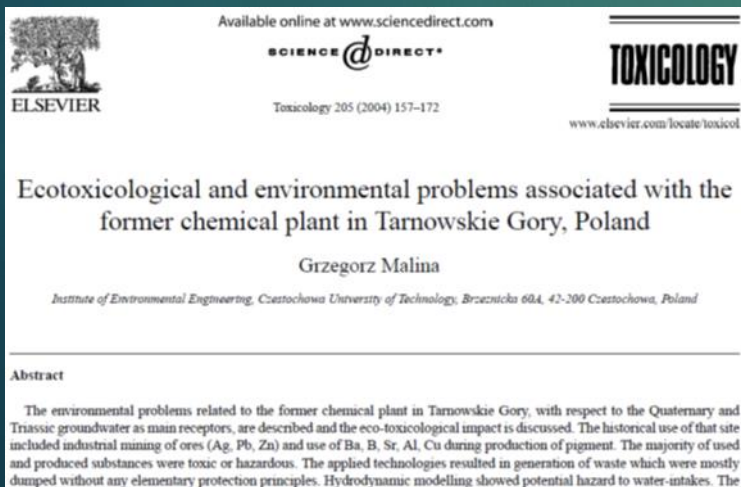

Monitoring network of groundwater organised from 1990:

- apart from soil contamination, Quaternary and Triassic groundwater aquifers are heavily polluted
- arsene, boron, barium, strontium and others, emission 400 tons/year
- 50 mln m<sup>3</sup> of groundwater polluted, up to 2 km from the source
- groundwater intakes are endangered.

## Quaternary aquifer

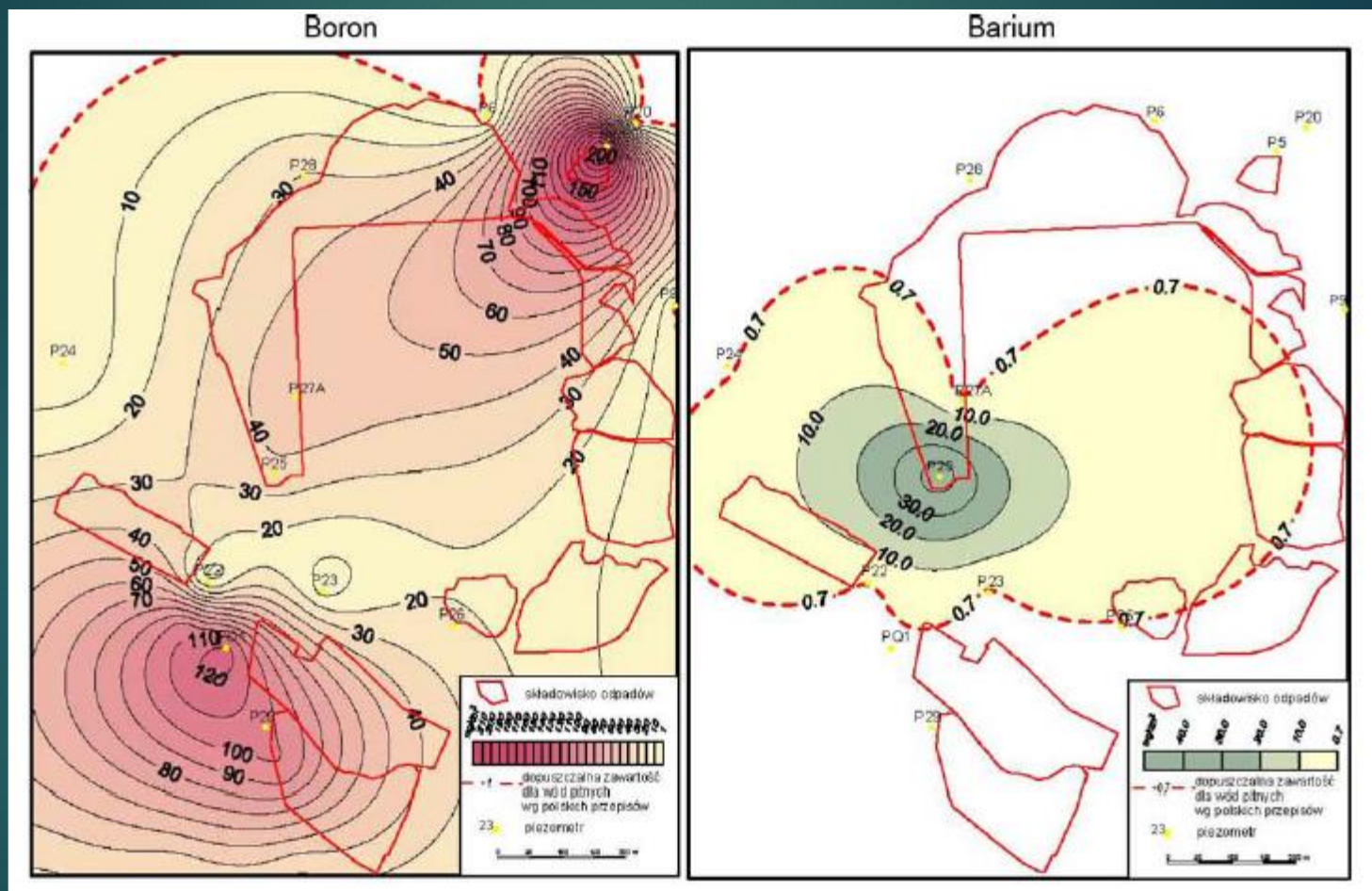

## Triassic aquifer

## Boron



Table 1  
The minimum and maximum values of selected parameters for the Quaternary groundwater (local monitoring data)

Parameter	Unit	Minimum	Maximum
pH	pH	4.3	8.3
Conductivity	mS	117	3970
Dissolved solids	mg/l	72.5	3120
COD	mg O <sub>2</sub> /l	0.6	38
Arsenic	mg As/l	nd <sup>a</sup>	0.04
Barium	mg Ba/l	nd	88
Boron	mg B/l	0.09	240
Zinc	mg Zn/l	0.016	57
Aluminium	mg Al/l	nd	3.7
Cadmium	mg Cd/l	nd	0.67
Manganese	mg Mn/l	nd	22.5
Copper	mg Cu/l	nd	0.7
Nickel	mg Ni/l	nd	0.21
Lead	mg Pb/l	nd	0.055
Strontium	mg Sr/l	nd	40

Table 2  
The minimum and maximum values of selected parameters for the Triassic groundwater (local monitoring data)

Parameter	Unit	Maximum	Minimum
pH	pH	5.95	10.4
Conductivity	mS	154	8530
Dissolved solids	mg/l	84	5850
COD	mg O <sub>2</sub> /l	0.5	59
Arsenic	mg As/l	nd	0.03
Barium	mg Ba/l	nd	722
Boron	mg B/l	nd	116
Zinc	mg Zn/l	nd	4.7
Aluminium	mg Al/l	nd	4.7
Cadmium	mg Cd/l	nd	0.12
Manganese	mg Mn/l	nd	6.45
Copper	mg Cu/l	nd	51
Nickel	mg Ni/l	nd	0.89
Lead	mg Pb/l	nd	0.037
Strontium	mg Sr/l	nd	30.6



Part 2

# Soil contamination standards



# Soil contamination standards

42

When to take remediation?

What should the remediation goals be?

Straightforward: restore “natural” conditions, as before contamination

BUT...

- financial constraints
- technical constraints
- time constraints.

THEN: Acceptable level (“How clean is clean?”)

- risk assessment: acceptable for human health and the state of environment

Priorities – effective use of available funds.

Standards: universal threshold values?

Convenient for administration, but really reasonable?

Individual approach – site specific assessment?

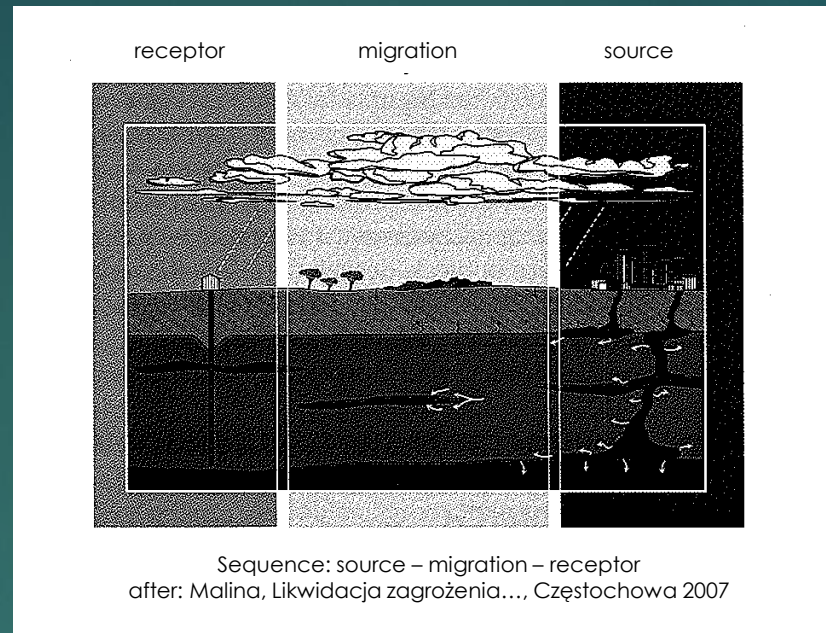

Source: Malina, 2007

## Factors important for risk assessment:

- ✓ distance to groundwater – ground layer
- ✓ groundwater migration
- ✓ water intakes placement
- ✓ distance to surface waters
- ✓ soil permeability
- ✓ presence of sensitive receptors (e.g. protected biotops...)
- ✓ area use, distance to used areas
- ✓ impact beyond immediate contaminated area.

POLAND: Environmental Protection Act (2001, changes introduced in 2014)

Title II: Protection of Environmental Resources,  
Section IV: Earth surface protection

Art. 101a. 1. Contamination of the earth surface shall be assessed on the basis of the exceedance of the permissible content of substances causing a risk in soil or in the ground.

*(Permissible content and manner of assessing the pollution of the Earth's surface is determined by the ordinance of the Minister of the Environment)*

Art. 101h. 1. The land owner, where historical soil pollution occurs, is obliged to carry out remediation.

*(There are a few exceptions, then the Regional Director of Environmental Protection carries out remediation, Art. 101i)*

*(Fortunately...)*

Art. 101p, para. 2. If the assessment of the presence of a significant risk to human health or the environment reveals that there is no significant risk to human health or the environment, the Regional Director for Environmental Protection may relieve the land owner or other perpetrator, by decision, from remediation or not carry out the remediation referred to in art. 101l.

*(Assessment of the presence of a significant risk is one of the elements of the remediation plan project submitted by the obligor to carry it out, Art. 101l)*

Art. 101P. 1. When assessing the presence of a significant risk to human health or the environment referred to in Article 101l par. 3 point 6, art. 101m sec. 2 point 1 lit. d and art. 101o paragraph 2 point 1 lit. d, account shall be taken in particular of:

- 1) the chemical form in which contamination occurs and its bioavailability;
- 2) the possibility of contamination spreading;
- 3) potential routes of exposure, taking into account the spread of pollutants depending on soil properties, morphology, geological structure and hydrogeological conditions, as well as land cover;
- 4) environment and people who could be affected by pollution;
- 5) occurrence of arable lands, gardens, parks, playgrounds, sports grounds, residential and commercial buildings, forms of nature protection, drinking water resources and water intakes in the contaminated area and its vicinity.

*(But...)*

Art 101p, para. 3. The minister competent for the environment in consultation with the minister competent for health matters, guided by the need to standardize the manner of assessing the occurrence of a significant risk to human health or the environment, **may** determine, by regulation, the procedure of assessing the occurrence of a significant risk to human health or the state of the environment and reference methodologies for modelling the spread of substances in soil, earth and groundwater.

*(May, but is not obliged... none so far)*

Art. 101q. para. 1. The following remediation methods are allowed:

1. the removal of contamination, at least to the permissible content of the hazardous substances in the soil and ground;

Art. 101q. para. 2 point 2. When planning or determining the way in which remediation should be carried out, the removal of the contamination referred to in para. 1 point 1 should be considered first.



*(Again luckily...)*

Art. 101g. paragraph. 3. Waiving from the removal of pollution, referred to in paragraph 1 point 1, and remediation in the manner referred to in paragraph 1 point 2, it is permissible if:

- 1) technologies or methods to remove contamination are not known or
- 2) negative environmental effects of activities carried out to remove pollution would be disproportionately high comparing to the benefits achieved in the environment, or
- 3) cleansing costs leading to the removal of pollution would be disproportionately high in relation to the benefits achieved in the environment and it is not reasonable to carry out remediation in the manner referred to in paragraph 1 point 2, which was demonstrated in the cost-benefit analysis carried out for several variants of the remediation method, or
- 4) obliged to carry out remediation will prove that the pollution occurred before 1 September 1980.

Art. 101q. section 1. point 2) (Remediation methods) other than indicated in point 1, leading to the removal of a significant risk to human health and the environment, including the current and, if possible, planned land use, such as:

- a) a reduction in the amount of pollution or
- b) limiting the possibility of contamination spreading and controlling pollution by periodically carrying out soil and ground contamination monitoring at specified times, or
- c) carrying out self-cleaning of the earth surface, possible actions enhancing self-cleaning, controlling pollution by periodically conducting soil and soil contamination monitoring at a given time, possibly limiting people's access to the contaminated area and possible need to change the way the polluted area is used.

*(Natural attenuation)*

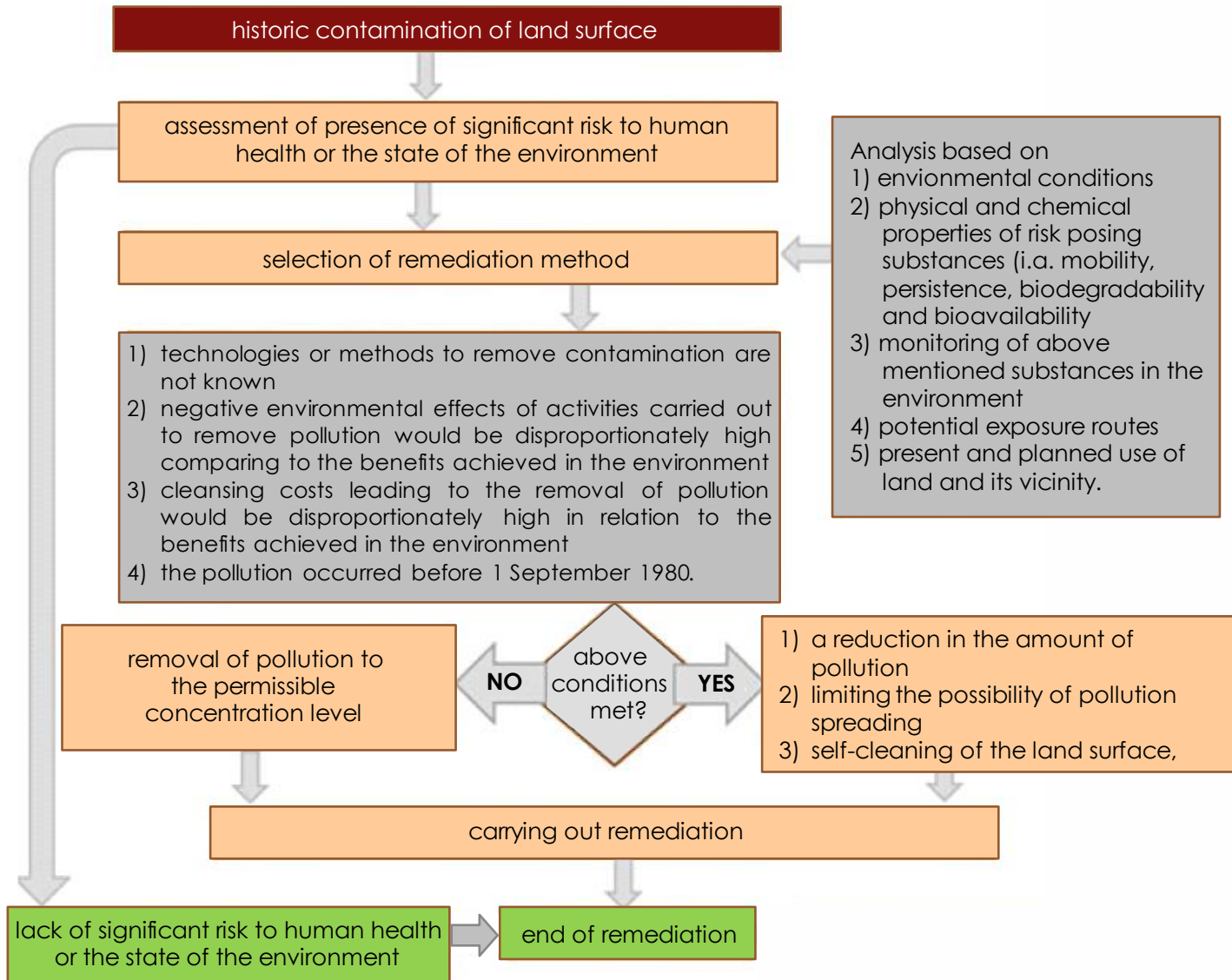

ORDINANCE OF THE MINISTER OF THE ENVIRONMENT of September 1, 2016.  
concerning assessment of the pollution of the earth's surface

§ 6. 1. The first stage of identification of a contaminated site includes determining the activity that may be the cause of pollution in a given area, now or in the past (...).

*(List of activities – Annex 2)*

§ 7. The second stage of identification of a contaminated site includes the establishment of a list of substances posing a risk that occur in the soil or in the ground on a given area (...).

*(An exemplary list of substances in connection with activities – Annex 2)*

## Załącznik nr 2

RODZAJE DZIAŁALNOŚCI MOGĄCYCH Z DUŻYM PRAWDOPODOBIENSTWEM POWODOWAĆ HISTORYCZNE ZANIECZYSZCZENIE POWIERZCHNI ZIEMI, WRAZ ZE WSKAZANIEM PRZYKŁADOWYCH DLA TYCH DZIAŁALNOŚCI ZANIECZYSZCZEN

1. Rodzaje działalności obejmujące eksploatację wybranych rodzajów instalacji mogących powodować znaczne zanieczyszczenie poszczególnych elementów przyrodniczych albo środowiska jako całości<sup>1)</sup>.

Lp.	Rodzaj działalności	Przykładowe zanieczyszczenia
Instalacje do wytwarzania energii i paliw		
1	Instalacja do spalania paliw <sup>2)</sup> o nominalnej mocy <sup>3)</sup> nie mniejszej niż 50 MW	<p>1. Metale i metaloid:</p> <ol style="list-style-type: none"> <li>1) arsen (As),</li> <li>2) bar (Ba),</li> <li>3) chrom (Cr),</li> <li>4) cyna (Sn),</li> <li>5) cynk (Zn),</li> <li>6) kadm (Cd),</li> <li>7) kobalt (Co),</li> <li>8) miedź (Cu),</li> <li>9) molibden (Mo),</li> <li>10) nikiel (Ni),</li> <li>11) ołów (Pb),</li> <li>12) rtęć (Hg).</li> </ol> <p>2. Wielopierścieniowe węglowodory aromatyczne:</p> <ol style="list-style-type: none"> <li>1) naftalen,</li> <li>2) antracen,</li> <li>3) chryzen,</li> <li>4) benzo(a)antracen,</li> </ol>

		<ol style="list-style-type: none"> <li>5) dibenzo(a,h)antracen,</li> <li>6) benzo(a)piren,</li> <li>7) benzo(b)fluoranten,</li> <li>8) benzo(k)fluoranten,</li> <li>9) benzo(ghi)perylene,</li> <li>10) indeno(1,2,3-c,d)piren.</li> </ol>
2	Instalacja do rafinacji ropy naftowej lub gazu	<ol style="list-style-type: none"> <li>1. Metale i metaloid:               <ol style="list-style-type: none"> <li>1) arsen (As),</li> <li>2) bar (Ba),</li> <li>3) chrom (Cr),</li> <li>4) cyna (Sn),</li> <li>5) cynk (Zn),</li> <li>6) kadm (Cd),</li> <li>7) kobalt (Co),</li> <li>8) miedź (Cu),</li> <li>9) molibden (Mo),</li> <li>10) nikiel (Ni),</li> <li>11) ołów (Pb),</li> <li>12) rtęć (Hg).</li> </ol> </li> <li>2. Zanieczyszczenia nieorganiczne:               <ol style="list-style-type: none"> <li>1) cyjanki wolne,</li> <li>2) cyjanki – związki kompleksowe.</li> </ol> </li> <li>3. Benzyny i oleje:               <ol style="list-style-type: none"> <li>1) suma węglowodorów C6-C12, składników frakcji benzyn,</li> <li>2) suma węglowodorów C12-C35, składników frakcji oleju.</li> </ol> </li> <li>4. Węglowodory aromatyczne:               <ol style="list-style-type: none"> <li>1) benzen,</li> <li>2) etylobenzen,</li> <li>3) toluen,</li> </ol> </li> </ol>

§ 8. 1. The third stage of identification of a contaminated site includes the collection and analysis of available and current sources of information relevant for the assessment of the risk of soil or land contamination in a given area, and available and current soil and land contamination monitoring data concerning risk posing substances from the list established in the second stage.

*(Current monitoring – maximum 10 years ago)*

§ 9. 1. The fourth stage of identification of a contaminated site includes the collection of information necessary to perform preliminary tests and the performance of preliminary tests (...).

*(Determination of the group of land, location of pollution sources, the scheme of soil sampling points location and depth, sampling, testing, analysis of results...)*

§ 10. 1. The fifth stage of identification of contaminated land includes detailed research (...).

*(Individual terrain scheme for the location of sampling points to determine the extent of contamination, sampling, testing, analysis of results...)*

The permissible content of substances posing the risk is determined depending on the land use:

- based on the register of lands and buildings

### Land group I

- living areas
- other building areas
- urban areas, not built-up
- built-up rural areas
- recreational areas



### Land group II

- arable lands
- meadows
- pastures
- areas under ponds and ditches
- garden plots



### Land group III

- forests
- areas with trees, bushes
- wastelands
- recreational areas
- ecological sites
- other



### Land group IV

- industrial areas
- mining areas
- transport areas



- or based on the local spatial development plan

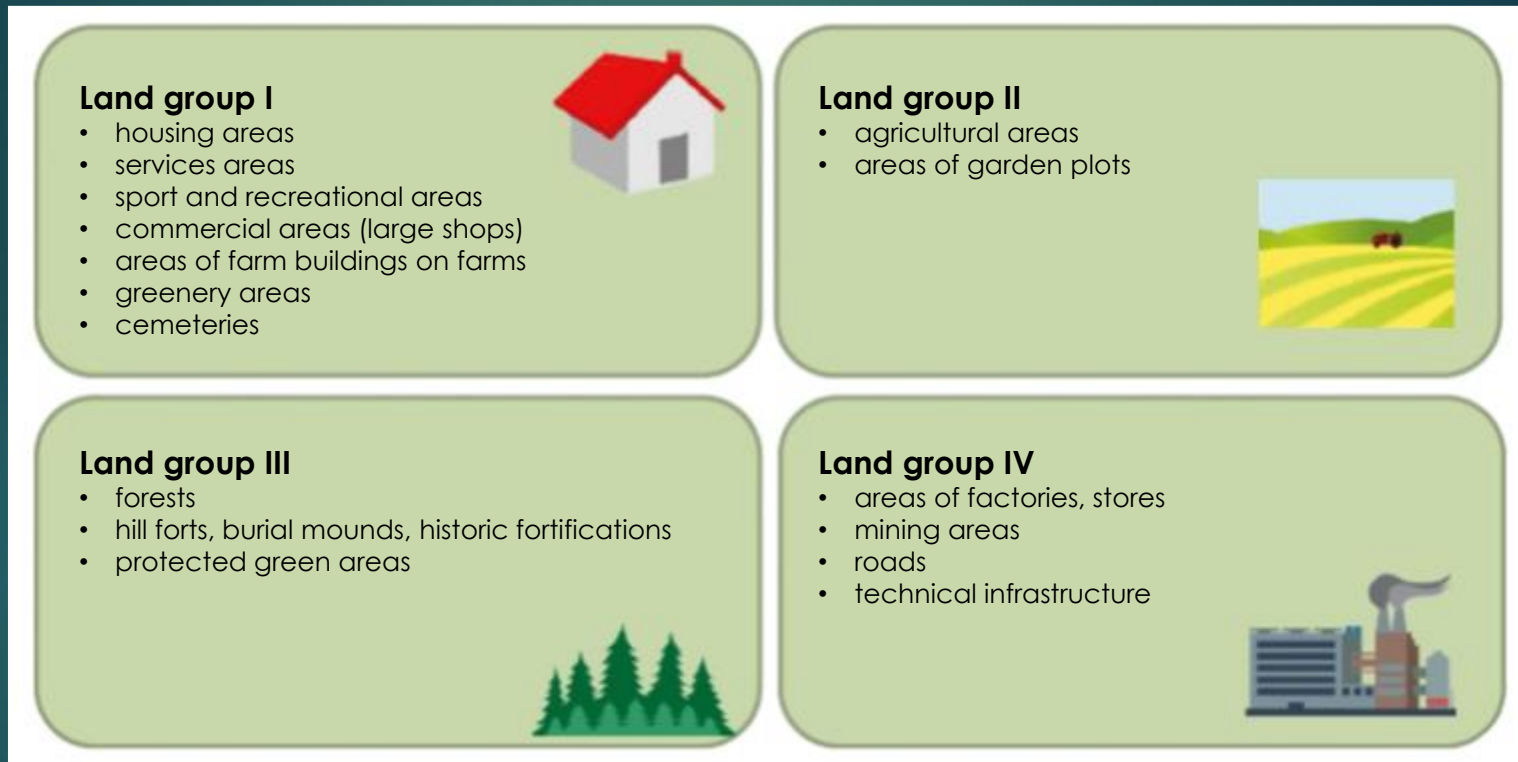

Source: Nowak, Kwapisz, 2017

Areas of water intakes, protection zones – group I  
National parks, reserves – group II



§ 3, pkt. 7. For the group of land II for a depth of 0–0.25 m below the ground level, the following subgroups of soils are determined based on soil properties: *(relevant for metals; consider: a) fraction of soil grains < 0.02 mm; b) pH of soil; c) organic matter content – TB note)*

- 1) subgroup of land II-1:
- 2) subgroup of land II-2:
- 3) subgroup of land II-3:

1) subgroup of land II-1:

- a) very light mineral soils with an FG02 fraction of less than 10%, regardless of the  $\text{pH}_{\text{KCl}}$  value,
- b) light mineral soils, with a FG02 fraction of 10-20%, with a  $\text{pH}_{\text{KCl}}$  value less than or equal to 6.5;

2) subgroup of land II-2:

- a) light mineral soils, with a FG02 fraction of 10-20%, with a  $\text{pH}_{\text{KCl}}$  value higher than 6.5,
- b) medium mineral soils, with a FG02 fraction of 20-35%, with a  $\text{pH}_{\text{KCl}}$  value less than or equal to 5.5,
- c) heavy mineral soils with an FGO 2 content greater than 35%, with a  $\text{pH}_{\text{KCl}}$  value less than or equal to 5.5,
- d) mineral-organic soils, with an organic carbon content of 3.5-6%, regardless of the  $\text{pH}_{\text{KCl}}$  value;

3) subgroup of land II-3:

- a) medium mineral soils, with a FG02 fraction of 20-35%, with a  $\text{pH}_{\text{KCl}}$  value higher than 5.5,
- b) heavy mineral soils, with a FG02 fraction of more than 35%, with a  $\text{pH}_{\text{KCl}}$  value higher than 5.5,
- c) mineral-organic and organic soils, with organic carbon content above 6%, regardless of the  $\text{pH}_{\text{KCl}}$  value.

## Other conditions important for setting permissible concentrations:

- The permissible contents are determined for a depth of 0–0.25 m below surface and below 0.25 m
- For below 0.25 m, the water permeability of the ground is additionally taken into account:  $\geq 10^{-7}$  m/s or  $<10^{-7}$  m/s

# land groups

surface layer, 0–0.25 m

59

Załącznik do rozporządzenia Ministra Środowiska z dnia 1 września 2016 r. (poz. 1395)

Załącznik nr 1

SUBSTANCJE POWODUJĄCE RYZYKO SZCZEGÓLNE I ISTOTNE DLA OCHRONY POWIERZCHNI ZIEMI, ICH DOPUSZCZALNE ZAWARTOŚCI W GLEBIE ORAZ DOPUSZCZALNE ZAWARTOŚCI W ZIEMI, ZROZNICOWANE DLA POSZCZEGÓLNYCH WŁAŚCIWOŚCI GLEBY ORAZ GRUP GRUNTÓW, WYDZIELONYCH W OPARCIU O SPOSÓB ICH UŻYTKOWANIA

1. Substancje powodujące ryzyko szczególnie istotne dla ochrony powierzchni ziemi oraz dopuszczalne zawartości tych substancji w glebie [mg/kg suchej masy części ziemistych gleby (<2 mm)<sup>1)</sup>], określone dla głębokości 0–0,25 m ppt, z podziałem uwzględniającym grupy gruntów, wydzielone w oparciu o sposób ich użytkowania, oraz podgrupy gruntów wydzielone w oparciu o właściwości gleby określone dla grupy gruntów II.

Lp.	Substancja	Dopuszczalne zawartości substancji powodujących ryzyko z podziałem na grupy i podgrupy gruntów					
		I	II			III	IV
<b>I. METALE I METALOID</b>							
		Podgrupa gruntów					
			II-1	II-2	II-3		
1	Arsen (As)	25	10	20	50	50	100
2	Bar (Ba)	400	200	400	600	1000	1500
3	Chrom (Cr)	200	150	300	500	500	1000
4	Cyna (Sn)	20	10	20	40	100	350
5	Cynk (Zn)	500	300	500	1000	1000	2000
6	Kadm (Cd)	2	2	3	5	10	15
7	Kobalt (Co)	50	20	30	50	100	200
8	Miedź (Cu)	200	100	150	300	300	600

Source: Dz.U. 2016 poz. 1395

9	Molibden (Mo)	50	10	25	50	100	250
10	Nikiel (Ni)	150	100	150	300	300	500
11	Ołów (Pb)	200	100	250	500	500	600
12	Rtęć (Hg)	5	2	4	5	10	30
<b>II. ZANIECZYŚCZENIA NIEORGANICZNE</b>							
1	Cyjanki wolne	1	1			5	20
2	Cyjanki – związki kompleksowe	5	5			20	50
<b>III. WĘGLOWODORY</b>							
<b>III.A. BENZYNY I OLEJE</b>							
1	Suma węglowodorów C6-C12, składników frakcji benzyn <sup>2)</sup>	1	1			50	500
2	Suma węglowodorów C12-C35, składników frakcji oleju <sup>3)</sup>	30	50			300	3000
<b>III.B. WĘGLOWODORY AROMATYCZNE</b>							
1	Benzen	0,1	0,1			10	100
2	Etylobenzen	0,1	0,1			10	100
3	Toluen	0,1	0,1			10	100
4	Ksyleny <sup>4)</sup>	0,1	0,1			10	100
5	Styren	0,1	0,1			6	60
<b>III.C. WIELOPIERSCIENIOWE WĘGLOWODORY AROMATYCZNE</b>							
1	Naftalen	0,1	0,1			1	20
2	Antracen	0,2	0,2			1	20
3	Chryzen	0,2	0,2			1	20
4	Benzo(a)antracen	0,1	0,1			1	20
5	Dibenzo(a,h)antracen	0,1	0,1			1	20
6	Benzo(a)piren	0,1	0,1			1	20
7	Benzo(b)fluoranten	0,1	0,1			1	20
8	Benzo(k)fluoranten	0,1	0,1			1	20
9	Benzo(ghi)perylene	0,2	0,2			1	20

10	Indeno(1,2,3-c,d)piren	0,2	0,2	1	20
IV. WĘGLOWODORY CHLOROWANE					
1	Alifatyczne chlorowane <sup>5)</sup>	0,01	0,01	0,01	5
2	Dichloroeten	0,01	0,01	0,01	5
3	Trichloroeten	0,01	0,01	0,01	5
4	Tetrachloroeten	0,01	0,01	0,01	5
5	Chlorobenzeny pojedyncze <sup>6)</sup>	0,01	0,01	0,01	15
6	Chlorofenole pojedyncze <sup>7)</sup>	0,01	0,01	0,01	1
7	Chloronafalen	0,01	0,01	0,01	1
8	PCB <sup>8)</sup>	0,02	0,02	0,02	2
V. ŚRODKI OCHRONY ROŚLIN					
V.A. PESTYCYDY CHLOROORGANICZNE					
1	DDT DDE DDD <sup>9)</sup>	0,0025	0,12	0,025	0,25
2	Aldryna	0,0025	0,025	0,025	0,25
3	Dieldryna	0,0005	0,005	0,005	0,50
4	Endryna	0,001	0,01	0,01	0,50
5	α-HCH <sup>10)</sup>	0,0025	0,025	0,025	1
6	β-HCH <sup>10)</sup>	0,001	0,01	0,01	0,5
7	γ-HCH <sup>10)</sup>	0,0001	0,01	0,001	0,05
V.B. PESTYCYDY - ZWIĄZKI NIECHLOROWE					
1	Carbaryl	0,05	0,2	0,2	0,2
2	Carbofuran	0,05	0,2	0,2	0,2
3	Maneb	0,05	0,2	0,2	0,2
4	Atrazyna	0,005	0,05	0,05	0,05
VI. POZOSTALE ZANIECZYSZCZENIA					
1	Tetrahydrofuran	0,1	0,1	2	50
2	Pyrydyna	0,1	0,1	2	30
3	Tetrahydrotiofen	0,1	0,1	2	60
4	Cykloheksan	0,1	0,1	5	80

5	Fenol	0,1	0,1	3	50
6	Krezole <sup>11)</sup>	0,1	0,1	3	50
7	Ftalany <sup>12)</sup>	0,1	0,1	10	60

Objaśnienia:

<sup>1)</sup> Sucha masa części ziemnych gleby (<2 mm) - masa wysuszona w temperaturze 105° C zgodnie z normą PN-ISO 11465 „Jakość gleby - Oznaczanie zawartości suchej masy gleby i wody w glebie w przeliczeniu na suchą masę gleby - Metoda wagowa”. Oznaczanie właściwości fizykochemicznych gleby i ziemi oraz zawartości zanieczyszczeń wykonuje się we frakcjach ziemnych (o średnicach <2 mm), po oddzieleniu na sicie frakcji gruboziarnistej (>2 mm). W uzasadnionych przypadkach, gdy istnieje przypuszczenie, że frakcje gruboziarniste mogą być źródłem zanieczyszczenia, należy oddzielnie poddać je analizie.

<sup>2)</sup> Suma wariantów węglowodorów stanowiących frakcję benzynu: alifatycznych, naftenowych i aromatycznych zawierających w cząsteczce od 6 do 12 atomów węgla, z uwzględnieniem węglowodorów monocromatycznych BTEX (benzen, toluen, etylobenzen i ksylenów).

<sup>3)</sup> Suma wariantów węglowodorów stanowiących frakcję oleju: alifatycznych, naftenowych i aromatycznych zawierających w cząsteczce od 12 do 35 atomów węgla i powyżej, z uwzględnieniem wielopierścieniowych węglowodorów aromatycznych WWA.

<sup>4)</sup> Ortoksylen, metaksylen, paraksylen.

<sup>5)</sup> Indywidualne związki: dichlorometan, trichlorometan, tetrachlorometan, chloroetan, 1,2-dichloroetan, 1,1,2-trichloroetan, 1,1,2,2-tetrachloroetan.

<sup>6)</sup> Monochlorobenzen, dichlorobenzeny, trichlorobenzeny, tetrachlorobenzeny, pentachlorobenzen i heksachlorobenzen.

<sup>7)</sup> Monochlorofenole (suma), dichlorofenole (suma), trichlorofenole (suma), tetrachlorofenole (suma) i pentachlorofenol.

<sup>8)</sup> Podane wartości progowe dotyczą każdego ze związków z grupy PCB, a w szczególności: PCB 28, PCB 52, PCB 101, PCB 118, PCB 138, PCB 153, PCB 180.

<sup>9)</sup> W znaczeniu DDT i jego metabolity to jest: DDT[1,1,1-trichloro-2,2-bis(4-chlorofenyl)etan], DDD[1,1-dichloro-2,2-bis(chlorofenyl)etylen] i DDE[1,1-dichloro-2,2-bis(p-chlorofenyl)etan].

<sup>10)</sup> HCH odpowiednio alfa, beta, gamma, w znaczeniu - 1,2,3,4,5,6-heksachlorocykloheksan.

<sup>11)</sup> Indywidualne izomery krezolu: ortokrezolu, metakrezolu, parakrezolu.

<sup>12)</sup> Indywidualne związki: ftalan dietylu, ftalan di-2-etyloheksyłu, ftalan butylu-benzylu, ftalan di-izo-butylu, ftalan di-n-butylu.

2. Substancje powodujące ryzyko szczególnie istotne dla ochrony powierzchni ziemi oraz dopuszczalne zawartości tych substancji w glebie i dopuszczalne zawartości tych substancji w ziemi [mg/kg suchej masy części ziemnych gleby (<2 mm)<sup>1)</sup>], określone dla głębokości przekraczającej 0,25 m ppt, z podziałem uwzględniającym grupy gruntów, wydzielone w oparciu o sposób ich użytkowania, oraz wodoprzepuszczalność gleby i ziemi.

Lp.	Substancja	Dopuszczalne zawartości substancji powodujących ryzyko z podziałem na grupy gruntów oraz wodoprzepuszczalność gleby i ziemi <sup>2)</sup>			
		II, III		IV	
		Wartość wyższa lub równa 1x10 <sup>-7</sup>	Wartość niższa niż 1x10 <sup>-7</sup> m/s	Wartość wyższa lub równa 1x10 <sup>-7</sup>	Wartość niższa niż 1x10 <sup>-7</sup> m/s

		m/s		m/s	
<b>I. METALE I METALOID</b>					
1	Arsen (As)	20	50	25	100
2	Bar (Ba)	300	600	300	3000
3	Chrom (Cr)	300	500	300	800
4	Cyna (Sn)	30	50	40	300
5	Cynk (Zn)	300	500	300	3000
6	Kadm (Cd)	3	5	6	20
7	Kobalt (Co)	30	60	50	300
8	Miedź (Cu)	150	300	200	1000
9	Molibden (Mo)	25	50	30	200
10	Nikiel (Ni)	100	200	100	500
11	Ołów (Pb)	100	300	200	1000
12	Rtęć (Hg)	3	5	4	50
<b>II. ZANIECZYSZCZENIA NIEORGANICZNE</b>					
1	Cyjanki wolne	5	10	5	100
2	Cyjanki - związki kompleksowe	5	10	5	500
<b>III. WĘGLOWODORY</b>					
<b>III.A. BENZYNY I OLEJE</b>					
1	Suma węglowodorów C6-C12, składników frakcji benzyn <sup>3)</sup>	50	500	50	750
2	Suma węglowodorów C12-C35, składników frakcji oleju <sup>4)</sup>	1000	3000	1000	3000
<b>III.B. WĘGLOWODORY AROMATYCZNE</b>					
1	Benzen	1	25	3	150
2	Etylobenzen	1	75	10	250
3	Toluen	1	75	5	230
4	Ksylene <sup>5)</sup>	1	35	5	150
5	Styren	1	5	2	100

<b>III.C. WIELOPIERSCIENIOWE WĘGLOWODORY AROMATYCZNE</b>					
1	Naftalen	5	20	10	40
2	Antracen	5	20	10	40
3	Chryzen	5	20	10	40
4	Benzo(a)antracen	5	20	10	40
5	Dibenzo(a,h)antracen	5	20	5	20
6	Benzo(a)piren	5	20	5	40
7	Benzo(b)fluoranten	5	20	5	20
8	Benzo(k)fluoranten	5	20	5	20
9	Benzo(ghi)perylene	5	20	5	100
10	Indeno(1,2,3-c,d)piren	5	20	5	20
<b>IV. WĘGLOWODORY CHLOROWANE</b>					
1	Alifatyczne chlorowane <sup>6)</sup>	0,1	5	1	20
2	Dichloroeten	0,1	5	0,1	5
3	Trichloroeten	0,1	5	0,1	5
4	Tetrachloroeten	0,1	5	0,1	5
5	Chlorobenzeny pojedyncze <sup>7)</sup>	0,1	2	0,5	10
6	Chlorofenole pojedyncze <sup>8)</sup>	0,1	1	0,2	5
7	Chloronaftalen	0,1	1	0,1	1
8	PCB <sup>9)</sup>	0,1	2	0,5	5
<b>V. ŚRODKI OCHRONY ROŚLIN</b>					
<b>V.A. PESTYCYDY CHLOROORGANICZNE</b>					
1	DDT/DDE/DDD <sup>10)</sup>	0,025	4	0,025	4
2	Aldryna	0,025	4	0,025	4
3	Dioldryna	0,005	4	0,005	4
4	Endryna	0,01	2	0,01	4
5	α-HCH <sup>11)</sup>	0,025	4	0,025	4
6	β-HCH <sup>11)</sup>	0,01	2	0,01	2
7	γ-HCH <sup>11)</sup>	0,001	0,5	0,001	0,5

V.B. PESTYCYDY – ZWIĄZKI NIECHLOROWE					
1	Carbaryl	0,1	5	0,1	5
2	Carbofuran	0,1	2	0,1	2
3	Maneb	0,1	35	0,1	35
4	Atrazyna	0,005	5	0,005	6
VI. POZOSTAŁE ZAMIECZYSZCZENIA					
1	Tetrahydrofuran	0,1	1	2	40
2	Pirydyna	0,1	1	1	20
3	Tetrahydrotiofen	0,1	1	2	50
4	Cykloheksan	0,1	1	5	80
5	Fenol	0,1	1	3	100
6	Krezole <sup>12)</sup>	0,1	1	3	100
7	Ftalany <sup>13)</sup>	0,1	5	10	60

Objasnienia:

- <sup>1)</sup> Sucha masa części ziemistych gleby (<2 mm) – masa wyznaczona w temperaturze 105° C zgodnie z normą PN-ISO 11465 „Jakość gleby – Oznaczanie zawartości suchej masy gleby i wody w glebie w przeliczeniu na suchą masę gleby – Metoda wagowa”. Oznaczanie właściwości fizykochemicznych gleby i ziemi oraz zawartości zanieczyszczeń wykonuje się we frakcjach ziemistych (o średnicach <2 mm), po oddzieleniu na sicie frakcji gruboziarnistych (>2 mm). W uzasadnionych przypadkach, gdy istnieje przypuszczenie, że frakcje gruboziarniste mogą być źródłem zanieczyszczenia, należy oddzielnie poddać je analizie.
- <sup>2)</sup> Wodoprzepuszczalność gleby i ziemi określa się wartością współczynnika filtracji.
- <sup>3)</sup> Suma wszystkich węglowodorów stanowiących frakcję benzyna: alifatycznych, naftenowych i aromatycznych zawierających w cząsteczce od 6 do 12 atomów węgla, z uwzględnieniem węglowodorów monocaromatycznych BTEX (benzen, toluen, etylobenzen i ksylenów).
- <sup>4)</sup> Suma wszystkich węglowodorów stanowiących frakcję oleju: alifatycznych, naftenowych i aromatycznych zawierających w cząsteczce od 12 do 35 atomów węgla i powyżej, z uwzględnieniem wielopierścieniowych węglowodorów aromatycznych WWA.
- <sup>5)</sup> Ortoksylen, metaksylen, paraksylen.
- <sup>6)</sup> Indywidualne związki: dichlorometan, trichlorometan, tetrachlorometan, chloroetan, 1,2-dichloroetan, 1,1,2-trichloroetan, 1,1,2,2-tetrachloroetan.
- <sup>7)</sup> Monochlorobenzen, dichlorobenzeny, trichlorobenzeny, tetrachlorobenzeny, pentachlorobenzen i heksachlorobenzen.
- <sup>8)</sup> Monochlorofenole (suma), dichlorofenole (suma), trichlorofenole (suma), tetrachlorofenole (suma) i pentachlorofenol.
- <sup>9)</sup> Podane wartości progowe dotyczą każdego ze związków z grupy PCB, a w szczególności: PCB 28, PCB 52, PCB 101, PCB118, PCB 138, PCB 153, PCB 180.
- <sup>10)</sup> W znaczeniu DDT i jego metabolity to jest: DDT[1,1,1-trichloro-2,2-bis(4-chlorofenyl)etan], DDD[1,1-dichloro-2,2-bis(chlorofenyl)etylen] i DDE[1,1-dichloro-2,2-bis(p-chlorofenyl) etan].
- <sup>11)</sup> HCH odpowiednio alfa, beta, gamma, w znaczeniu - 1,2,3,4,5,6-heksachlorocykloheksan.
- <sup>12)</sup> Indywidualne izomery krezolu: ortokrezolu, metakrezolu, parakrezolu.
- <sup>13)</sup> Indywidualne związki: ftalan dietylu, ftalan di-2-etyloheksylu, ftalan butylu-benzylu, ftalan di-izo-butyłu, ftalan di-n-butyłu.

The permissible content of substances other than those specified is determined based on:

- 1) the characteristics of the substance posing the risk, together with the indication of hazard classes listed in EU directives
- 2) risk characterization to human health, in particular:
  - a) for substances with a toxic effect – probability of a risk to human health,
  - b) for substances with carcinogenic or mutagenic effects – additional, above the natural level in the environment, probability of occurrence of cancer  $R < 1 \times 10^{-5}$
- 3) analysis of existing methods for testing soil and soil pollution, taking into account the limit of detection and determination of a given substance in soil and ground.

## Current Polish regulation:

- + more precise
- + introduction of risk assessment concept
- + there is no absolute obligation for remediation
- + remediation through natural attenuation is possible

## But...

- the records regarding the risk assessment are not very precise
- sometimes very low permissible values, being at the same time target values



Original Research

## Evaluation of the Status of Contamination of Arable Soils in Poland with DDT and HCH Residues; National and Regional Scales

Barbara Maliszewska-Kordybach\*, Bożena Smreczak, Agnieszka Klimkiewicz-Pawlas

Institute of Soil Science and Plant Cultivation State Research Institute,  
Department of Soil Science and Land Conservation, Czarnyociski 8, 24-100 Puławy, Poland

Received: 16 July 2013

Accepted: 18 December 2013

### Abstract

The aim of our study was to evaluate the content of organochlorine pesticides (DDTs and HCHs) in the upper layer of arable soils in Poland. 214 soil samples were analyzed for the content of three HCH congeners ( $\alpha$ -HCH,  $\beta$ -HCH, and  $\gamma$ -HCH) and three DDT compounds (pp'DDT, pp'DDE, and pp'DDD). The median soil concentration of  $\Sigma$ DDT was 24.39  $\mu\text{g kg}^{-1}$ , while for  $\Sigma$ HCH it was 2.85  $\mu\text{g kg}^{-1}$  with the highest contribution of  $\gamma$ -HCH isomer. Polish criteria for agricultural soils not polluted with DDTs are met by half of the samples. In the case of  $\gamma$ -HCH the Polish limit value of 0.5  $\mu\text{g kg}^{-1}$  was met in 6.5% of the samples. However, according to the less restrictive systems applied in other countries (Canada, Romania) none of the soil samples contain a hazard due to contamination with DDTs, and only 6-11% exhibit too high concentrations of  $\gamma$ -HCH (values of Lindane). The mean contents of DDTs and  $\gamma$ -HCH in soils from different provinces varied widely with the reverse interdependence of both groups of pesticides. The districts with the highest concentrations of DDT (Podlaskie, Wielkopolskie, and Mazowieckie) were characterized by the lowest mean residues of Lindane. This suggests the long-term effects of the prescriptive state system of distribution of pesticides used in Poland more than 40 years ago.

**Keywords:** arable soil quality, soil contamination, organochlorine pesticides, DDTs, HCHs, Lindane

### Introduction

Organochlorine pesticides (OCPs) were for many years applied widely in agriculture. They enter soils mainly through direct application (local pesticide usage), but on a global scale all soils are exposed to the inputs of OCPs from atmospheric depositions, which contribute substantially to the loads of those substances in the terrestrial environment [1, 2]. The very important groups of OCPs are hexachlorocyclohexanes (HCHs) and dichlorodiphenylchloroethanes (DDTs), which were used worldwide as pesticides before their application was restricted in the 1970s because of high persistence and toxicity [3-5].

\*e-mail: bmalid@iung.pulawy.pl

The most popular isomer from the HCH group is  $\gamma$ -HCH, the main component (98%) of pesticide Lindane was applied widely in the past in Poland and other countries as an insecticide and fumigant for a wide range of soil-dwelling and plant-eating (phytophagous) insects [7, 9]. It was commonly used on a wide variety of crops, in warehouses, in public health to control insect-borne diseases, and (with fungicides) as a seed treatment [6-8]. Besides application as a pesticide,  $\gamma$ -HCH was applied in the pharmaceutical industry, by veterinarians and as an impregnating agent [1, 7, 9]. Lindane is persistent in most soils, with a field half-life of 1-2 years and is classified as a moderately toxic compound in EPA toxicity class II [10]. In accordance with the decision of the European Commission, the utilization of Lindane for plant protection on EU territory



Fig. 1. Sampling point map of the area. The main cities of the administrative provinces are marked: Wrocław – Dolnośląskie (Lower Silesia Province), Bydgoszcz – Kujawsko-Pomorskie (Kujawo-Pomerania Province), Lublin – Lubelskie (Lublin Province), Zielona Góra – Lubuskie (Lubuska Province), Łódź – Łódzkie (Łódź Province), Kraków – Małopolskie (Małopolska Province), Warszawa – Mazowieckie (Mazowiecka Province), Opole – Opolskie (Opolska Province), Rzeszów – Podkarpackie (Podkarpacka Province), Białystok – Podlaskie (Podlaska Province), Gdańsk – Pomorskie (Pomorska Province), Katowice – Śląskie (Śląskie Province), Kielce – Świętokrzyskie (Świętokrzyska Province), Olsztyn – Warmińsko-Mazurskie (Warmińsko-Mazurska Province), Poznań – Wielkopolskie (Wielkopolska Province), and Szczecin – Zachodniopomorskie (Zachodniopomorska Province).

# Monitoring of DDT i HCH pesticide content in Polish arable soils, year 2005 (Institute of Soil Science and Plant Cultivation (IUNG) Puławy)

65

214 composite samples from 0–0.20 m layer

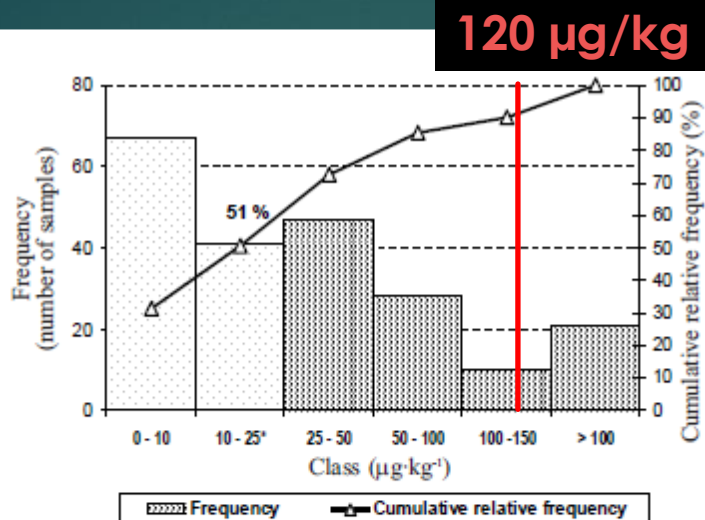

Fig. 2. Histogram of  $\Sigma 3\text{DDT}$  concentrations in arable soils in Poland. \*) limit value for the upper layer of soils of agricultural use according to Polish regulations [36]; bars with lighter shading denote classes below limit value.

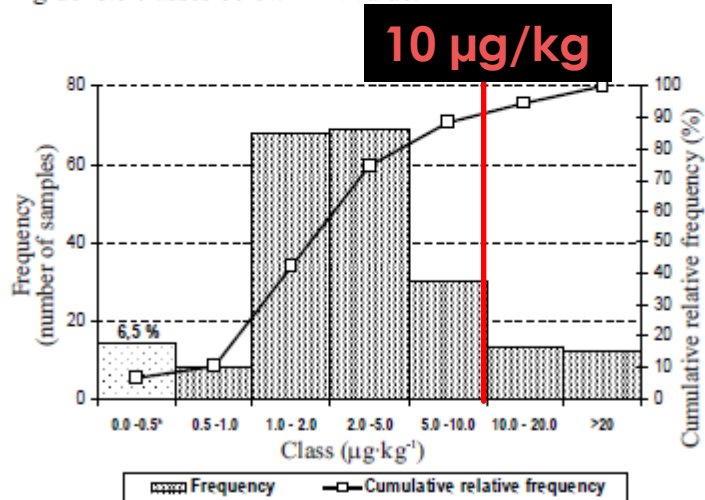

Fig. 3. Histogram of  $\gamma\text{-HCH}$  concentrations in arable soils in Poland. \*) limit value for the upper layer of soils of agricultural use according to Polish regulations [36]; bar with lighter shading denotes class below limit value.

The screenshot shows the website of the Ministry of Environment (Ministerstwo Środowiska) in Poland. The page title is "Wyjaśnienie" (Explanation) and the URL is "https://www.mos.gov.pl/kalendarz/szczegoly/news/wyjasnienie-1/". The article is dated 09.06.2016 and discusses the project of a ministerial ordinance regarding the assessment of soil contamination. Key points from the text include:

- Remediation of contaminated land:** The ordinance clarifies that the obligation to remediate arises from the project, not from the 2001 Act on Environmental Protection. It states: "Nie są to więc przepisy nowe, a obowiązujące od 15 lat." (These are not new provisions, but those in force since 15 years ago).
- General rule of responsibility:** The ordinance establishes a general rule of responsibility for landowners for historical contamination, with an exception for cases where the contamination was caused by a third party (e.g., a nearby industrial facility).
- Soil research:** The ordinance regulates the manner of soil research but does not impose a specific obligation to conduct it: "nie nakłada natomiast obowiązku ich wykonania." (it does not impose the obligation of their execution).

The article concludes by stating that the assessment of soil contamination will be carried out in accordance with the provisions of the ordinance.

Source: <https://www.mos.gov.pl/kalendarz/szczegoly/news/wyjasnienie-1/>

“However, the adoption of a solution based on individual risk assessment, for each case of pollution, without indicating any acceptable levels of substances causing risk in soil or in the ground would result in an excessive burden on both businesses and administrations. Even in simple cases, it would be necessary to carry out costly toxicological, ecotoxicological, epidemiological and exposure routes assessments. The issuance of the ordinance will allow to avoid such a risk and to harmonize the manner of proceeding in this matter”.

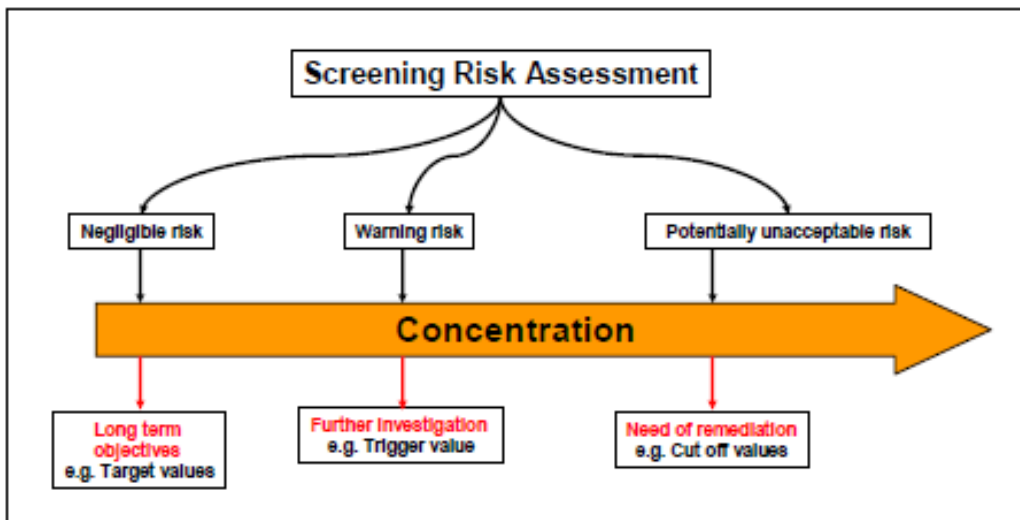

Figure 2.1. Example of derivation of screening values based on various risk levels and different screening values applications

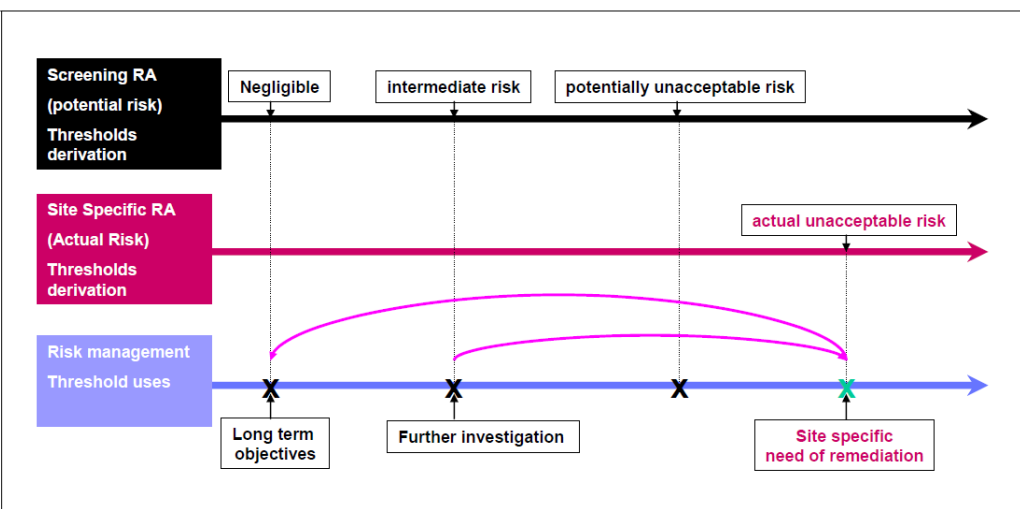

Figure 2.2. Example of a framework for the derivation and use of risk based threshold values.



DERIVATION METHODS OF SOIL SCREENING VALUES IN EUROPE. A REVIEW AND EVALUATION OF NATIONAL PROCEDURES TOWARDS HARMONISATION

EDITOR  
CLAUDIO CARLON



EUR 22805 EN - 2007

Table 2.1. Type of screening values and site-specific risk assessment in European Member States (16 countries)

Legend: Austria (AUT); Belgium Flanders (BE(F)); Belgium Bruxelles (BE(B)), Belgium Walloon (BE(W)); Czech Republic (CZE); Finland (FIN); Italy (ITA); Lithuania (LTU); Netherlands (NLD); Poland (POL); Slovakia (SVK); United Kingdom (UK); Denmark (DNK)

Countries	NEGLIGIBLE RISK		INTERMEDIATE RISK		UNACCEPTABLE RISK	
	Screening RA	Site-specific RA	Screening RA	Site-specific RA	Screening RA	Site-specific RA
AT			Trigger value Further investigation		Intervention values (in principle to be remediated) (only for some contaminants)	SS-Inter. Define the need for remediation and target concentrations
NL	Target value (long term objectives)				Intervention values	Define urgency of remediation. Remedial concentration targets for immobile contaminants
IT					Limit values (in principle to be remediated)	SS-Inter. Define the need for remediation and target concentrations
BE-FL	Background first target for remediation, but BATNEEC applies		Further investigation (for historical contaminants only)		Clean-up standards (for new contaminants only)	SS-Inter. Only for historic pollution: need for remediation. It can support BATNEEC
BE-W	Reference value (Background) Target for remediation		Trigger values Further investigation		Intervention values (in principle to be remediated)	SS-Inter. Only for historic pollution: need for remediation. It can support BATNEEC

Countries	NEGLECTIBLE RISK		INTERMEDIATE RISK		UNACCEPTABLE RISK	
	Screening RA	Site-specific RA	Screening RA	Site-specific RA	Screening RA	Site-specific RA
CZ	A. (long term objectives)		B. Further investigation		C. (in principle to be remediated)	
DK			Soil Quality Criteria		Cut-off values (in principle to be remediated – for immobile cont.)	
DE			Trigger values Further investigation		Action levels (in principle to be remediated)	SS-Inter. Define the need for remediation and target
ES			Guidance values Further investigation, or site specific assessment			SS-Inter. Define the need for remediation and target
FI			Threshold values site specific assessment required		Lower and Upper guidelines	
SE			Triquer values Further investigation			
SK	A Target for remediation in groundwater sensitive area		B target for remediation in groundwater less sensitive areas		C Intervention values (in principle to be remediated)	
PL					Maximum Permissible Concentrations (in principle to be remediated)	
LT					Maximum Permissible Concentrations (in principle to be remediated)	
IT					Limit values (in principle to be remediated) also remediation targets	SS-Inter. Define residual concentration limits
UK			Soil Screening Values for ecological receptors. Triggers for further investigation	Refinements made to measured field concentrations (the PEC) and then compared with SSVs for ecological receptors. Triggers for further investigation	Soil guideline values Site specific assessment required	SS-Inter. Define the need and target for remediation

## The Netherlands:

contaminated min. 25 m<sup>3</sup> or 100 m<sup>3</sup> of saturation zone  
 term remediation "urgency" –  
 unacceptable threat to the environment:

- for people
- for the ecosystem
- spreading pollution

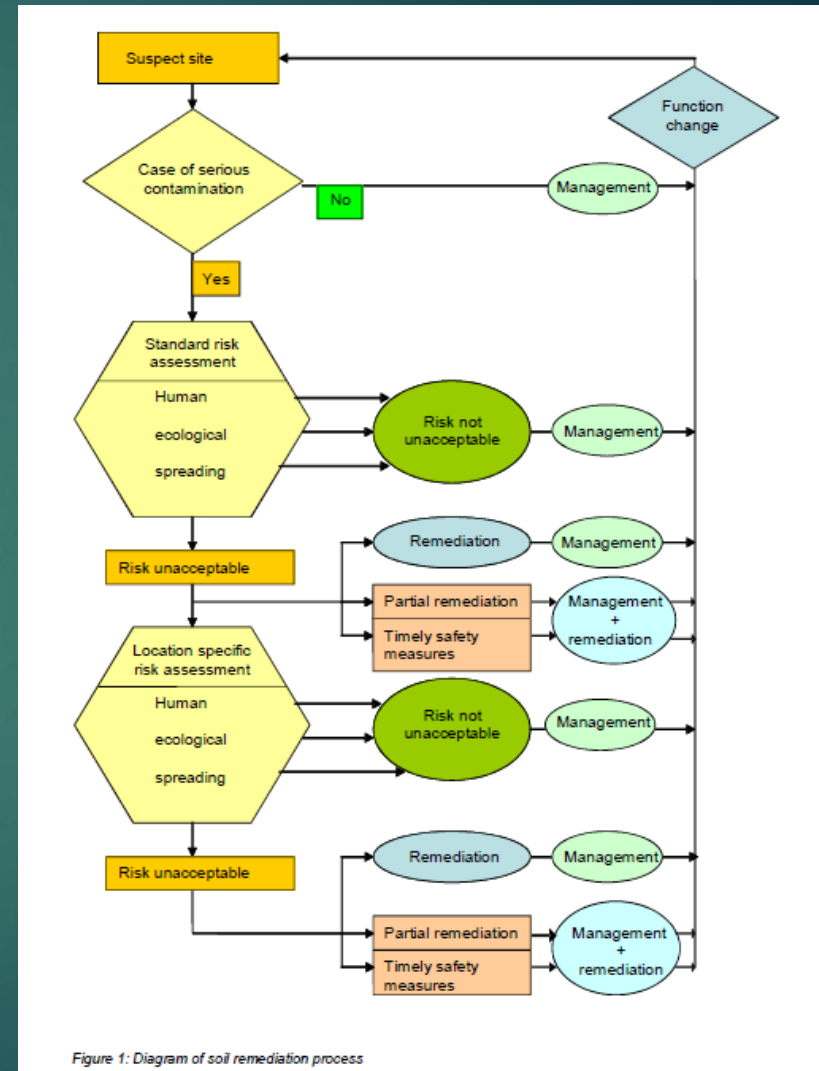
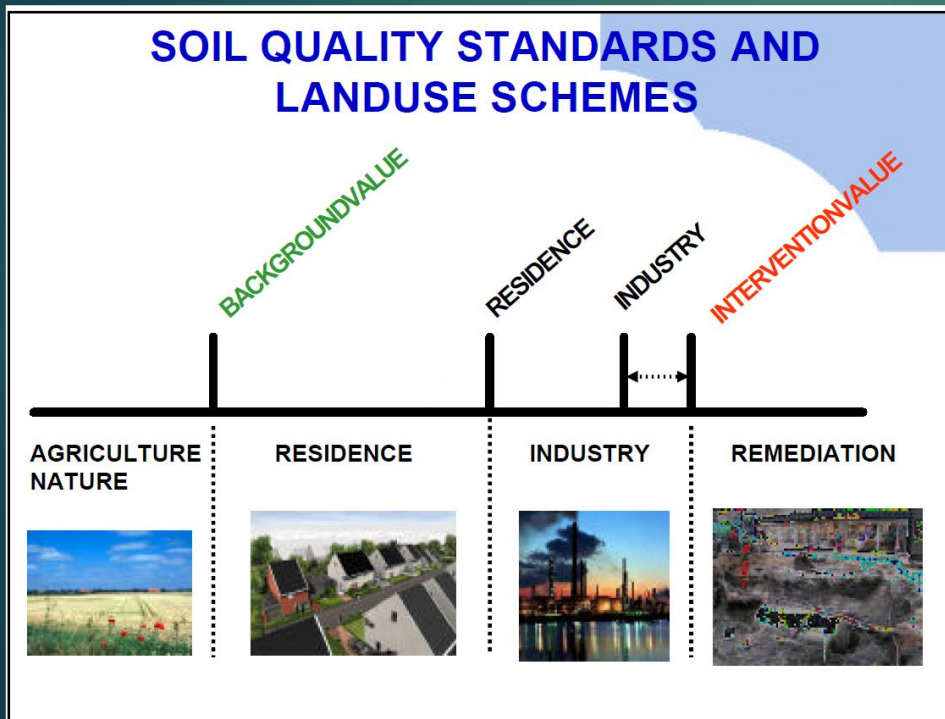

Figure 1: Diagram of soil remediation process

**Table 1: Groundwater Target Values and soil and groundwater Intervention Values<sup>1</sup>**

Concentrations in soil are shown for standard soil (10% organic matter and 25% lutite).

Substance	Target Value	Intervention Values	
	Groundwater <sup>U</sup> (µg/l)	Soil (mg/kg DM)	Groundwater (µg/l)
<b>e. Other chlorinated hydrocarbons</b>			
Monochloroanilines (aggr.) <sup>^</sup>	-	50	30
Dioxin (aggr. TEQ) <sup>^</sup>	-	0.00018	N/A <sup>*</sup>
Chloronaphthalene (aggr.) <sup>^</sup>	-	23	6
<b>6. Pesticides</b>			
<b>a. Organochloride pesticides</b>			
Chlordane (aggr.) <sup>^</sup>	0.02 ng/l <sup>*</sup>	4	0.2
DDT (aggr.) <sup>^</sup>	-	1.7	-
DDE (aggr.) <sup>^</sup>	-	2.3	-
DDD (aggr.) <sup>^</sup>	-	34	-
DDT/DDE/DDD (aggr.) <sup>^</sup>	0.004 ng/l <sup>*</sup>	-	0.01
Aldrin	0.009 ng/l <sup>*</sup>	0.32	-
Dieldrin	0.1 ng/l <sup>*</sup>	-	-
Endrin	0.04 ng/l <sup>*</sup>	-	-
Drins (aggr.) <sup>^</sup>	-	4	0.1
α-endosulphan	0.2 ng/l <sup>*</sup>	4	5
α-HCH	33 ng/l	17	-
β-HCH	8 ng/l	1.6	-
γ-HCH (lindane)	9 ng/l	1.2	-
HCH compounds (aggr.) <sup>^</sup>	0.05	-	1
Heptachlor	0.005 ng/l <sup>*</sup>	4	0.3
Heptachloroepoxide (aggr.) <sup>^</sup>	0.005 ng/l <sup>*</sup>	4	3
<b>b. Organophosphate pesticides</b>			
-			
<b>c. Organotin pesticides</b>			
Organotin compounds (aggr.) <sup>^</sup>	0.05 <sup>*</sup> – 16 ng/l	2.5	0.7
<b>d. Chlorophenoxy-acetic acid herbicides</b>			
MCPA	0.02	4	50
<b>e. Other pesticides</b>			
Atrazine	29 ng/l	0.71	150
Carbaryl	2 ng/l <sup>*</sup>	0.45	50
Carbofuran <sup>B</sup>	9 ng/l	0.017	100



## Groundwater protection and quality:

### EU Water Framework Directive (2000):

- defining and characterizing groundwater bodies
- establishment of protected areas
- establishment of monitoring
- etc.

### Directive on the protection of groundwater against pollution and deterioration (2006):

- Nitrates: 50 mg/l
- Active substances in pesticides, including their relevant metabolites, degradation and reaction products (1): 0.1 µg/l; 0.5 µg/l (total)

### Establishment of threshold values by states (minimum list):

- Arsenic, Cadmium, Lead, Mercury, Ammonium, Chloride, Sulphate
- Trichloroethylene, Tetrachloroethylene
- Conductivity

Information about groundwater bodies at risk.

ORDINANCE OF THE MINISTER OF THE ENVIRONMENT  
of 21 December 2015 on the criteria and method of  
assessment of the status of groundwater bodies.

74

Groundwater body – means a defined volume of groundwater occurring within an aquifer or a set of aquifers that enables significant uptake in water supply or flow of significant intensity to shape the desired state of surface waters and terrestrial ecosystems.

Currently, 172 groundwater bodies exist over Poland's territory (PGI, 2016–2021).

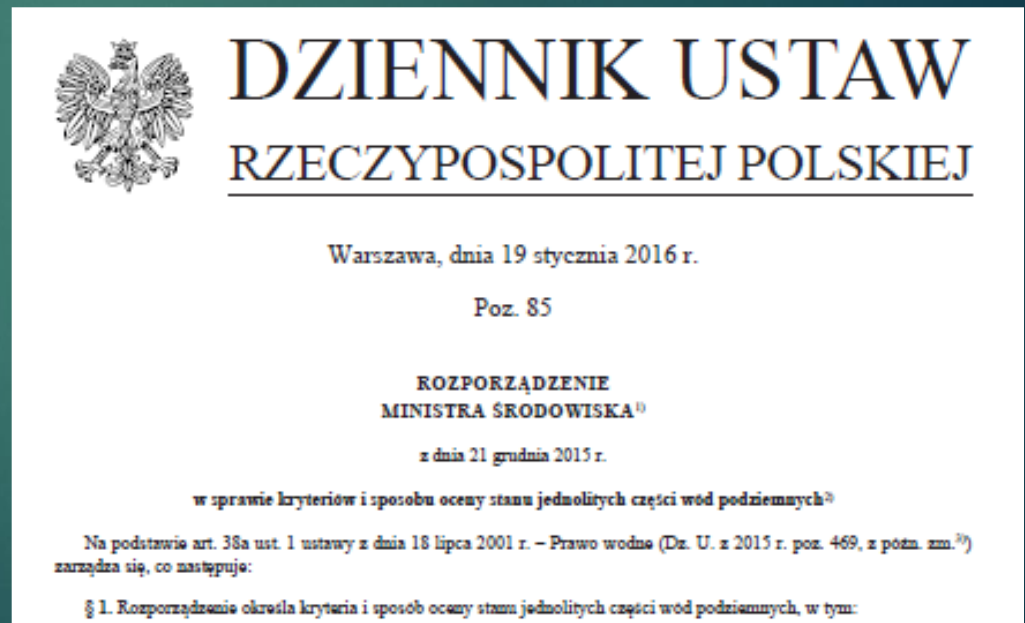

The current classification distinguishes five classes of groundwater quality:

- 1) Class I – very good quality water in which:
  - a) the values of physicochemical elements are formed only as a result of natural processes occurring in groundwater and are within the hydrogeochemical background range
  - b) the values of physicochemical elements do not indicate the impact of human activity
  
- 2) Class II – good quality water in which:
  - a) the values of some physicochemical elements are elevated as a result of natural processes occurring in groundwater
  - b) the values of physicochemical elements do not indicate the impact of human activity or it is a very weak impact

- 3) Class III – waters of satisfactory quality, in which the values of physicochemical elements are elevated as a result of natural processes occurring in groundwater or low impact of human activity
- 4) Class IV – water of unsatisfactory quality, in which the values of physicochemical elements are elevated as a result of natural processes occurring in groundwater and a clear impact of human activity
- 5) Class V – poor quality water, in which the values of physicochemical elements confirm the significant impact of human activity

## WARTOŚCI GRANICZNE ELEMENTÓW FIZYKOCHEMICZNYCH STANU WÓD PODZIEMNYCH

Lp.	Numer CAS dla substancji chemicznych	Element fizykochemiczny	Jednostka	Tło hydrogeochemiczne <sup>1)</sup>	Wartości graniczne <sup>2)</sup> w klasach jakości I-V				
					I	II	III <sup>3)</sup>	IV	V
Elementy ogólne:									
1	Brak	Odczyn	pH	6,5-8,5	6,5-9,5			<6,5 lub >9,5	
2	Brak	Ogólny węgiel organiczny	mgC/l	1-10	5	10 <sup>4)</sup>	10 <sup>4)</sup>	20	>20
3	Brak	Przewodność elektrolityczna w 20 °C	µS/cm	200-700	700	2500 <sup>4)</sup>	2500 <sup>4)</sup>	3000	>3000
4	Brak	Temperatura	°C	4-20	<10	12	16	25	>25
5	80937-33-3	Tlen rozpuszczony	mg/l	0-5	>1	0,5-1	<0,5 <sup>4)</sup>	<0,5 <sup>4)</sup>	<0,5 <sup>4)</sup>
Elementy nieorganiczne:									
6	8007-57-6	Amonowy jon	mgNH <sub>4</sub> /l	0-1	0,5	1,0	1,5	3	>3
7	35734-21-5	Antymon <sup>H</sup>	mgSb/l	0-0,001	0,005 <sup>4)</sup>	0,005 <sup>4)</sup>	0,005 <sup>4)</sup>	0,1	>0,1
8	7440-38-2	Arsen <sup>H</sup>	mgAs/l	0,00005-0,020	0,01 <sup>4)</sup>	0,01 <sup>4)</sup>	0,02	0,2	>0,2
9	84145-82-4	Azotany <sup>H</sup>	mgNO <sub>3</sub> /l	0-5	10	25	50	100	>100
10	14797-65-0	Azotyny <sup>H</sup>	mgNO <sub>2</sub> /l	0-0,03	0,03	0,15	0,5	1	>1
11	7440-39-3	Bar	mgBa/l	0,01-0,3	0,3	0,5	0,7	3	>3
12	1932-52-9	Beryl	mgBe/l	0-0,0005	0,0005	0,05	0,1	0,2	>0,2
13	7440-42-8	Bor <sup>H</sup>	mgB/l	0,01-0,50	0,5	1 <sup>4)</sup>	1 <sup>4)</sup>	2	>2
14	Brak	Chlorki	mgCl/l	2-60	60	150	250	500	>500
15	7440-47-3	Chrom <sup>H</sup>	mgCr/l	0,0001-0,010	0,01	0,05 <sup>4)</sup>	0,05 <sup>4)</sup>	0,1	>0,1
16	57-12-5	Cyjanki wolne <sup>H</sup>	mgCN/l	-	0,01	0,05 <sup>4)</sup>	0,05 <sup>4)</sup>	0,1	>0,1

48	Brak	Substancje ropopochodne <sup>H</sup>	mg/l	0	0,01	0,1	0,3	5	>5
49	Brak	Pestycydy <sup>5) H</sup>	mg/l	0	0,0001 <sup>4)</sup>	0,0001 <sup>4)</sup>	0,0001 <sup>4)</sup>	0,005	>0,005
50	Brak	Suma pestycydów <sup>6) H</sup>	mg/l	0	0,0005 <sup>4)</sup>	0,0005 <sup>4)</sup>	0,0005 <sup>4)</sup>	0,0025	>0,0025
51	Brak	Substancje powierzchniowo czynne anionowe	mg/l	0	0,1	0,2	0,5	1	>1
52	Brak	Substancje powierzchniowo czynne anionowe i niejonowe	mg/l	0	0,1	0,2	0,5	1	>1
53	127-18-4	Tetrachloroetylen <sup>H</sup>	mg/l	0-0,0005	0,001	0,01	0,05	0,1	>0,1
54	79-01-6	Trichloroetylen <sup>H</sup>	mg/l	0-0,003	0,001	0,01	0,05	0,1	>0,1
55	Brak	WWA <sup>7) H</sup> wielopierścieniowe węglowodory aromatyczne	mg/l	0,000001-0,0001	0,0001	0,0002	0,0003	0,0005	>0,0005

Objaśnienia:

- 1) Tło hydrogeochemiczne według Katalogu wybranych fizycznych i chemicznych wskaźników zanieczyszczeń wód podziemnych i metod ich oznaczania – S. Witczak, A. F. Adamczyk, 1995 (zmodyfikowane).
- 2) W przypadku metali podane wartości graniczne odnoszą się do ich formy rozpuszczonej.
- 3) Wartości graniczne dla III klasy jakości są wartościami progowymi dla dobrego stanu chemicznego.
- 4) Brak dostatecznych podstaw do zróżnicowania wartości granicznych w niektórych klasach jakości. Przy klasyfikacji do oceny przyjmuje się klasę o najwyższej jakości spośród klas posiadających tę samą wartość graniczną.
- 5) Termin „pestycydy” obejmuje organiczne: insektycydy, herbicydy, fungicydy, nematocydy, akarycydy, algicydy, rodentycydy, slimicydy oraz produkty pochodne i ich pochodne metabolity, a także produkty ich rozkładu i reakcji. Oznacza się tylko te pestycydy, których występowania w wodzie można oczekiwać. Określone dla pestycydów wartości graniczne stosuje się do każdego poszczególnego pestycydu.
- 6) Suma pestycydów oznacza sumaryczną zawartość poszczególnych pestycydów wykrytych i oznaczonych ilościowo w ramach badań monitoringowych.
- 7) Wielopierścieniowe węglowodory aromatyczne obejmują sumę: benzo(b)fluorantenu, benzo(k)fluorantenu, benzo(a)piranu, dibenzo(a,h)antracenu, benzo(g,h,i)perylenu oraz indeno(1,2,3-cd)pirenu.
- H Element fizykochemiczny, dla którego nie dopuszcza się przekroczenia wartości granicznej przy określaniu klasy jakości wód podziemnych w punkcie pomiarowym.

## ORDINANCE OF THE MINISTER OF HEALTH dated 7<sup>th</sup> of December 2017 on the quality of water intended for human consumption

Other standards: WHO recommendations,  
other countries



# DZIENNIK USTAW RZECZYPOSPOLITEJ POLSKIEJ

Warszawa, dnia 11 grudnia 2017 r.

Poz. 2294

**ROZPORZĄDZENIE  
MINISTRA ZDROWIA<sup>1)</sup>**

z dnia 7 grudnia 2017 r.

w sprawie jakości wody przeznaczonej do spożycia przez ludzi<sup>2)</sup>

Na podstawie art. 13 ustawy z dnia 7 czerwca 2001 r. o zbiorowym zaopatrzeniu w wodę i zbiorowym odprowadzaniu ścieków (Dz. U. z 2017 r. poz. 328, 1566 i 2180) zarządza się, co następuje:

§ 1. 1. Rozporządzenie określa:

Country	Approach for assessing contaminated sites	Guidance and legal instruments framing site assessment
<b>Austria</b>	Environmental quality standards and site-specific risk assessment.	ALSAG <sup>(58)</sup> ; water act <sup>(59)</sup> ; waste-management act <sup>(60)</sup> . Austrian Standard ÖNORM S 2088 (part 1: groundwater; part 2: soil; part 3: air) <sup>(61)</sup> .
<b>Belgium (Buxelles-Capitale)</b>	For single pollution and mixed pollution: exceeding soil-remediation standards. For orphan pollution: site-specific risk assessment.	Decree on soil remediation and soil management <sup>(62)</sup> . S-Risk model.
<b>Belgium (Flanders)</b>	Historical contamination is evaluated using site-specific risk assessment. New contamination is addressed comparing values with soil-quality standards approach.	S-Risk model <sup>(63)</sup> .
<b>Belgium (Wallonia)</b>	Screening values laid down in soil decree and site-specific risk assessment.	Soil decree <sup>(64)</sup> . S-Risk model.
<b>Bulgaria</b>	Site-specific risk assessment for historical and new pollution.	Liability for preventing and remedying environmental damage act (Lpreda) <sup>(65)</sup> .
<b>Cyprus</b>	Soil-quality standards and site-specific risk assessment are used indistinctly depending on each situation.	No formal procedure.
<b>Czech Republic</b>	Thresholds and site-specific risk assessment.	<i>Methodological guidelines</i> (Svoboda, 1997).
<b>Denmark</b>	Threshold values for contact risk and site-specific risk assessment for groundwater contamination.	JAGG 2.1 tool <sup>(66)</sup> .
<b>Estonia</b>	Site-specific risk assessment to prioritise intervention and screening values to consider remediation completed.	Water Base Management plans <sup>(67)</sup> . Water act <sup>(68)</sup> .
<b>Finland</b>	Site-specific risk assessment, but guideline values can also be applied to	Decree on the assessment of soil contamination and remediation needs <sup>(69)</sup>



Art. 101p. 1. When assessing the occurrence of a significant risk to human health or the environment referred to in Article 101l par. 3 point 6, art. 101m sec. 2 point 1 lit. d and art. 101o paragraph 2 point 1 lit. d, account shall be taken in particular of:

- 1) the chemical form in which contamination occurs and its bioavailability;
- 2) the possibility of contamination spreading;
- 3) potential routes of exposure, taking into account the spread of pollutants depending on soil properties, morphology, geological structure and hydrogeological conditions, as well as land cover;
- 4) environment and people who could be affected by pollution;
- 5) occurrence of arable lands, gardens, parks, playgrounds, sports grounds, residential and commercial buildings, forms of nature protection, drinking water resources and water intakes in the contaminated area and its vicinity.

The risk assessment procedures used are to determine the possibility of adverse effects of pollution in the following aspects:

- on human health (*Human (Health) Risk Assessment – HRA*) (health risk)
- on ecological parameters (*Ecological Risk Assessment – ERA*) (environmental risk)
- on quality of agricultural production.

Different levels of detail

Different approaches

## Health risk

The individual stages of the assessment:

1. Collection of data on the distribution, type and amount of pollution
2. Distribution of concentrations in the ground, groundwater, pore air
3. Expected toxic effects: for carcinogens, **the likelihood of cancer** in relations to dose, for toxic substances acceptable **threshold dose**
4. Risk estimation for various exposure routes

*(on the basis of:  
Decision Support System for Exposure and Risk Assessment)*

# Stage 1

## initial site investigation

### initial site assessment

concentrations in soil/groundwater exceed screening standards?

no

end of assessment

yes

### detailed assessment of health risk

#### basic assessment of health risk

data processing

exposure assessment scenarios of land use (industrial, living, etc.)

toxicity assessment

risk characterization

health risk exceeds acceptable level?

no

no action

yes

determination of local, health-safe concentrations in soil/groundwater

assessment of different remediation methods

choice of optimal remediation method

## Scenarios

- living area
- industrial
- trade area
- recreational

### Exposure scenarios / Routes of exposure

exposure route	exposure scenario / receptor				
	living area / adults, children			industrial area / adults	
	soil – surface layer	deep soil	ground water	soil – surface layer	deep soil
accidental ingestion of polluted soil	√			√	
dermal contact with polluted soil	√			√	
inhalation of polluted soil particles	√			√	
inhalation of volatile substances vapors from soil		√			√
consumption of polluted water			√		
dermal contact with polluted water during bathing or shower			√		
inhalation of volatile substances vapors during water use in household			√		

## Default values of exposure parameters

Symbol	parameter	unit	living area		industrial
			child	adult	adult
EF	exposure frequency	days/year	350	350	240*
ED	exposure time	years	6	24	40**
BW	body mass	kg	15	70	70
IR <sub>o</sub>	accidental ingestion of soil per day	mg/day	200	100	100
SA	skin area in contact with polluted soil	cm <sup>2</sup>	2 800	5 700	3 300
AF	adhesion factor of polluted soil to skin	mg/cm <sup>2</sup> /day	0.2	0.07	0.2
IR <sub>i</sub>	respiration factor – magnitude of daily ventilation of lungs	m <sup>3</sup> /day	10	20	20
non cancerogenic substances	mean time of exposure; AT = ED × 365 days/year	days	2 190	8 760	14 600
cancerogenic substances	mean time of exposure; AT = 70 years × 365 days/year	days	25 550	25 550	25 550

\* assumed number of working days per year in Poland, including 14-day leave

\*\* years of work in the lifetime

Source: adapted from US EPA 1991, 2002, 2004

## Exposure assessment – calculation of dose taken

$$\mathbf{CDI = C \times \frac{IR \times EF \times ED}{BW} \times \frac{1}{AT}}$$

CDI – taken dose of chemical substance (mg/kg body mass/day)

C – concentration of substance in soil/water during exposure (mg/kg)

IR – contact factor: amount of polluted soil/water in contact with organism in time unit, e.g. accidental daily soil ingestion(mg/day)

EF – exposure frequency(days/year)

ED – exposure time (years)

BW – body mass (kg)

AT – exposure averaging time (days); for non-cancerogenic substances:

AT = ED × 365 days/year, for cancerogenic: AT = 70 years × 365 days/year

### Non-cancerogenic risk

- Calculation of hazard quotient (HQ) for polluting substances

$$\mathbf{HQ = CDI/RfD}$$

- Calculation of hazard index (HI) – sum of HQs calculated for individual substances and exposure routes

### Cancerogenic risk

- Calculation of cancerogenic risk (CR) for polluting substances

$$\mathbf{CR = CDI \times SF}$$

- Calculation of total CR – sum of CRs calculated for individual substances and exposure routes



## Going to Level 2 (more detailed and site-specific):

Site-specific standards – taking into consideration:

- exposure point
- transport and dispersion of pollutants in the water and groundwater environment
- the impact of natural attenuation
- transport processes between phases (e.g. ground-water, ground-atmosphere)
- etc.

# HUMAN RISKS – EXPOSURE PATHWAYS

- BY THE NATIONAL INSTITUTE FOR PUBLIC HEALTH AND THE ENVIRONMENT (RIVM)
- ENGLISH VERSION AVAILABLE ON [www.rivm.nl](http://www.rivm.nl)

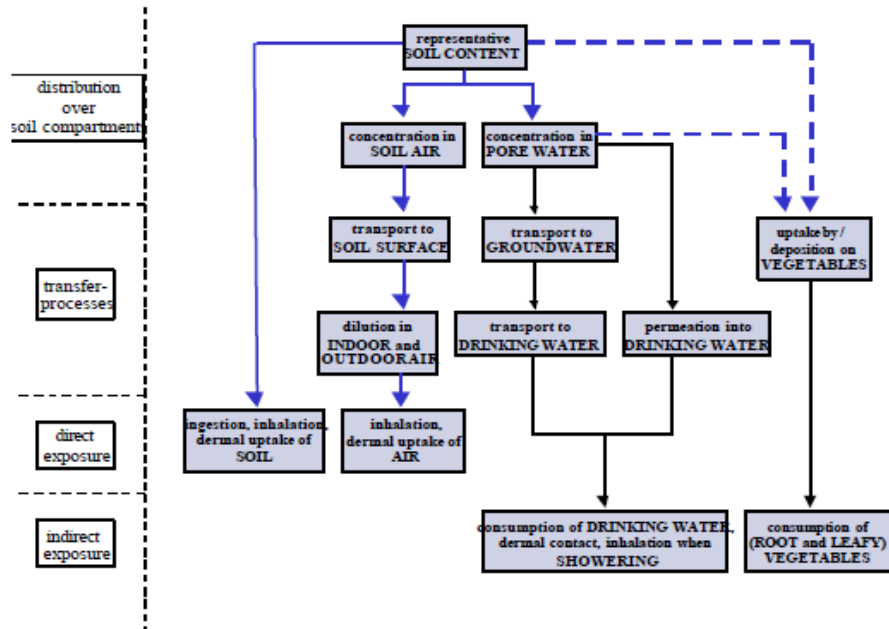

## HUMAN RISKS

1. MAXIMUM PERMISSIBLE RISK
  - REFERENCE DOSE IN  $\mu\text{g}$  per kg Bodyweight per day
  - DERIVED FROM EU AND WHO STANDARDS
2. MODELING OF EXPOSURE (CSOIL) PATHWAYS (CSOIL MODEL):
  - INGESTION OF SOIL PARTICLES
  - CROP CONSUMPTION
  - INHALATION OF INDOOR AIR
  - DRINKING WATER

## Ecological risk

The simplest methods – comparing predicted concentrations with reference values (e.g.)

*NOEC – no observed effect concentration*; results from test on selected organisms; is the highest tested concentration for which there are no statistical significant difference of effect when compared to the control group.

*PNEC – predicted no effect concentration*; is the concentration of a substance in any environment below which adverse effects will most likely not occur during long term or short term exposure, usually lowest NOEC or LC divided by safety factor).

Multi-phase approach – more and more detailed levels of risk assessment.



# Ecological Risk Assessment of Contaminated Land

Decision support for site specific investigations

John Jensen and Miranda Mesman

STUDIA I RAPORTY IUNG-PIB

ZESZYT 35(9): 155-179

2013

Agnieszka Klimkowicz-Pawlas, Barbara Maliszewska-Kordybach,  
Bożena Smreczak

*Instytut Uprawy Nawożenia i Gleboznawstwa – Państwowy Instytut Badawczy  
w Puławach*

**METODY OCENY RYZYKA EKOLOGICZNEGO TERENÓW NARAŻONYCH  
NA ODDZIAŁYWANIE ZANIECZYSZCZEŃ ORGANICZNYCH\***

**Słowa kluczowe:** ocena ryzyka ekologicznego, metody ERA, procedura Triad, zanieczyszczenia organiczne, gleby rolnicze

Wstęp

Podstawowy dokument Unii Europejskiej w zakresie ochrony gleb „Strategia tematyczna w dziedzinie ochrony gleby” (11) wskazuje na konieczność zachowania

## Basic flowchart ecological risk assessment

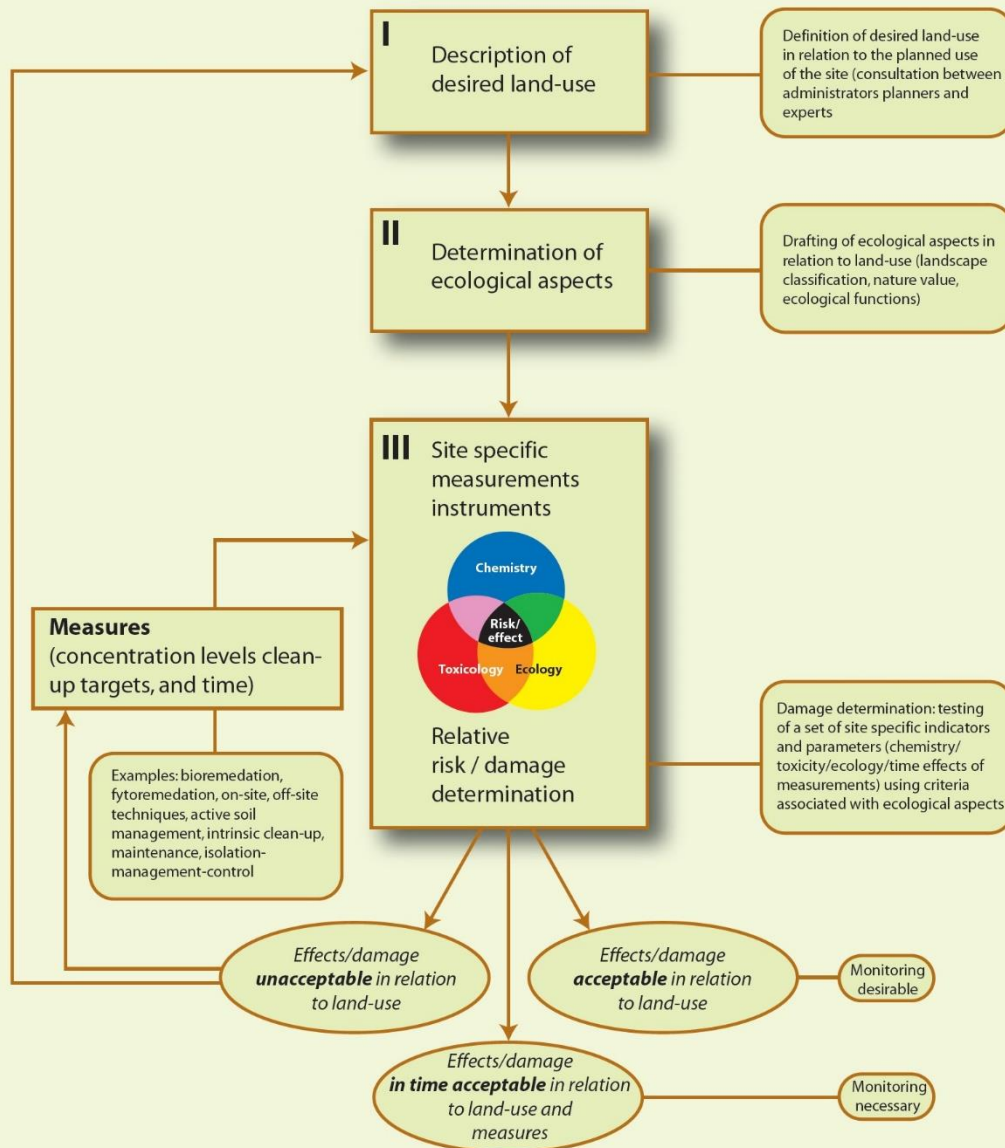

Gathering as much available information as possible, such as exact terrain characteristics, taking into account the level and extent of contamination occurrence, as well as defining the expected manner of land use (industrial, urban or agricultural areas).

In order to determine the relationship: source of contamination → route of exposure → receptor, ecological receptors relevant to a given manner of land use are identified.

Data specific for a given area (site-specific risk assessment) using one of the methods of evidence assessment (weight of evidence), applying the so-called Triad method. This method includes information obtained from chemical analyzes, ecotoxicological studies and ecological observations.

**Chemistry:** The concentration of contaminants in the environment (totals, bioavailable), accumulated in biota, or modelled via food-chains is used for calculation of risks on the basis of toxicity data from the literature.

**Toxicology:** Bioassays with species across genera are carried out in order to measure the actual toxicity present in environmental samples from the site.

**Ecology:** Field ecological observations at the contaminated site are compared to the reference site. Deviations from the reference site, which can be plausibly attributed to the contamination levels, are funnelled into the Triad.

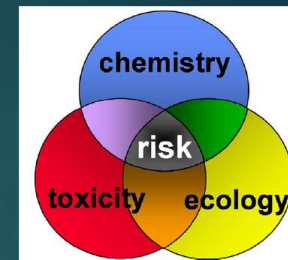

Examples of chemical analyzes and ecotoxicological tests applicable to individual stages of the Triad procedure, developed on the basis of Jensen and Mesman (27)

Assessment stage	Tests for individual lines of evidence		
	Chemical	(Eco)toxicological	Ecological
Screening assessment	Total pollution content PAF (fraction of potentially threatened species)	An acute test with luminescent bacteria (Microtox, including solid-phase) – A chronic test with luminescent bacteria (24 h) – Invertebrate tests: Ostracodtoxkit Ceriodaphtoxkit Thamnotoxkit Rotoxkit Protoxkit	Visit in the field, evaluation of visible plant cover changes, presence or absence of specific plants

## Bioavailability of contaminants

### General consensus:

- Risk assessment based on the total concentration of pollutants leads to its over-estimation
- Pollutants undergo various bonding processes in soils
- Only the bioavailable fraction is important for the risk assessment.

## Chemical measurements

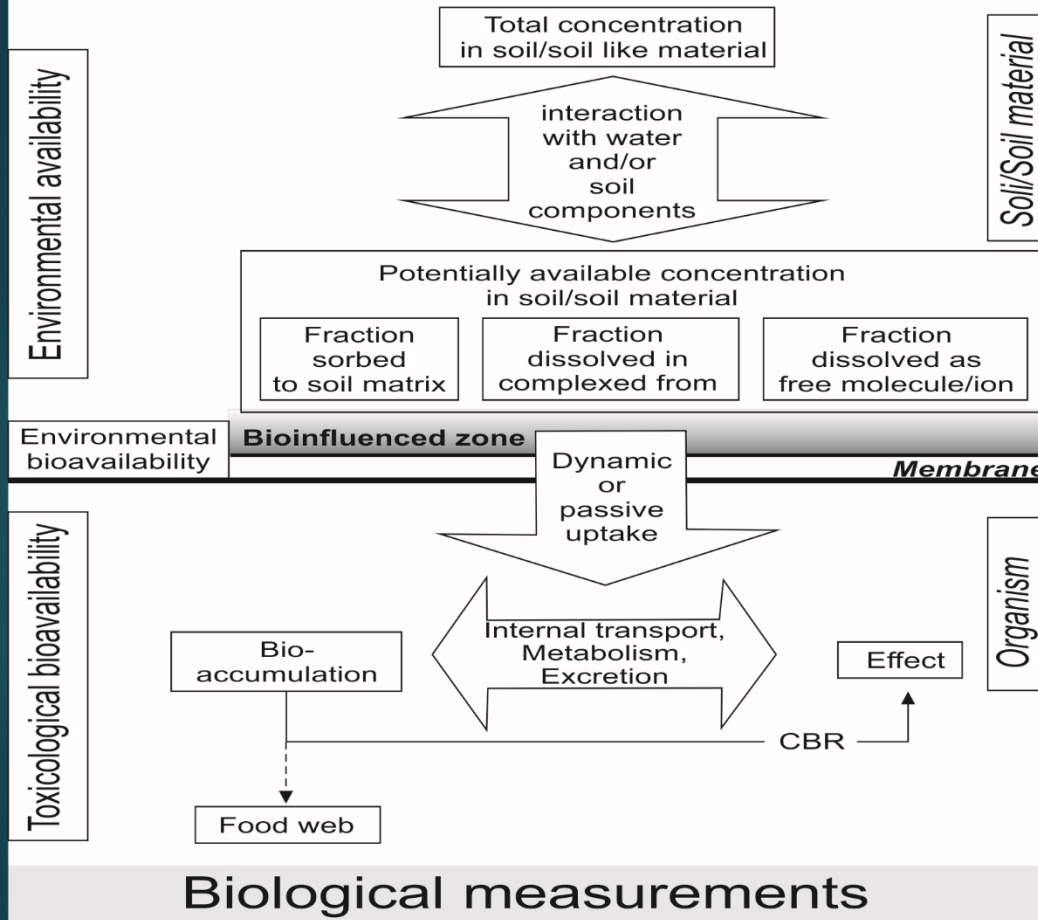

## Chemical measurements (available fractions)

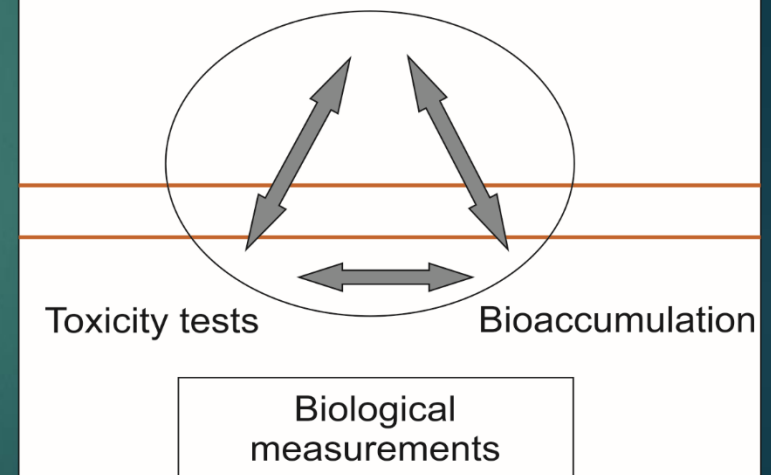



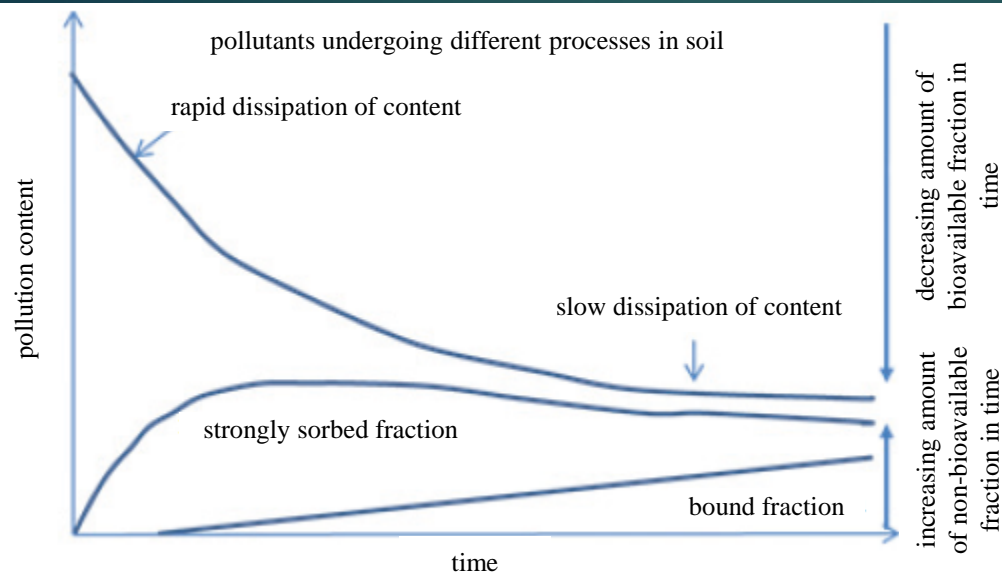

Two-phased degradation of PAHs in soils and changes of their bioavailability in relations to soil contact time

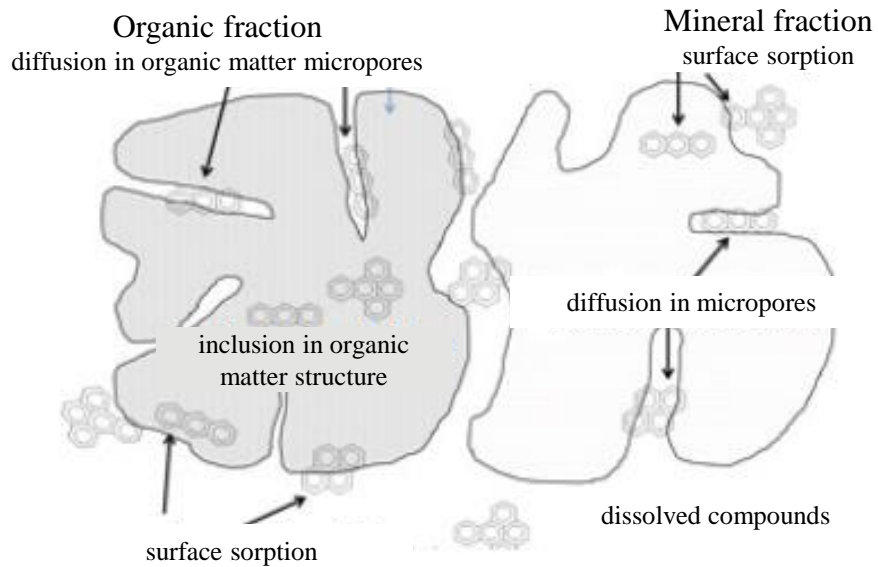

Pollutant aging processes in soil

Source: Smreczak, Klimkowicz-Pawlas, Maliszewska-Kordybach, 2013

STUDIA I RAPORTY IUNG-PIB

ZESZYTY 35(9): 137-153

2013

Bożena Smreczak, Agnieszka Klimkowicz-Pawlas,  
Barbara Maliszewska-Kordybach

*Instytut Uprawy Nawożenia i Gleboznawstwa – Państwowy Instytut Badawczy  
w Puławach*

BIODOSTĘPNOŚĆ TRWAŁYCH ZANIECZYSZCZEŃ ORGANICZNYCH  
(TZO) W GLEBACH\*

Assessment methods (ISO 17402):

Heavy metals

- Concentration in pore waters: extraction with a neutral solution
- Sorbed concentration: extraction with an acid solution
- Uptake by organisms: various tests.

# Hydrophobic organic contaminants (HOCs):

- sorbent-based extraction: Tenax, cyclodextrins

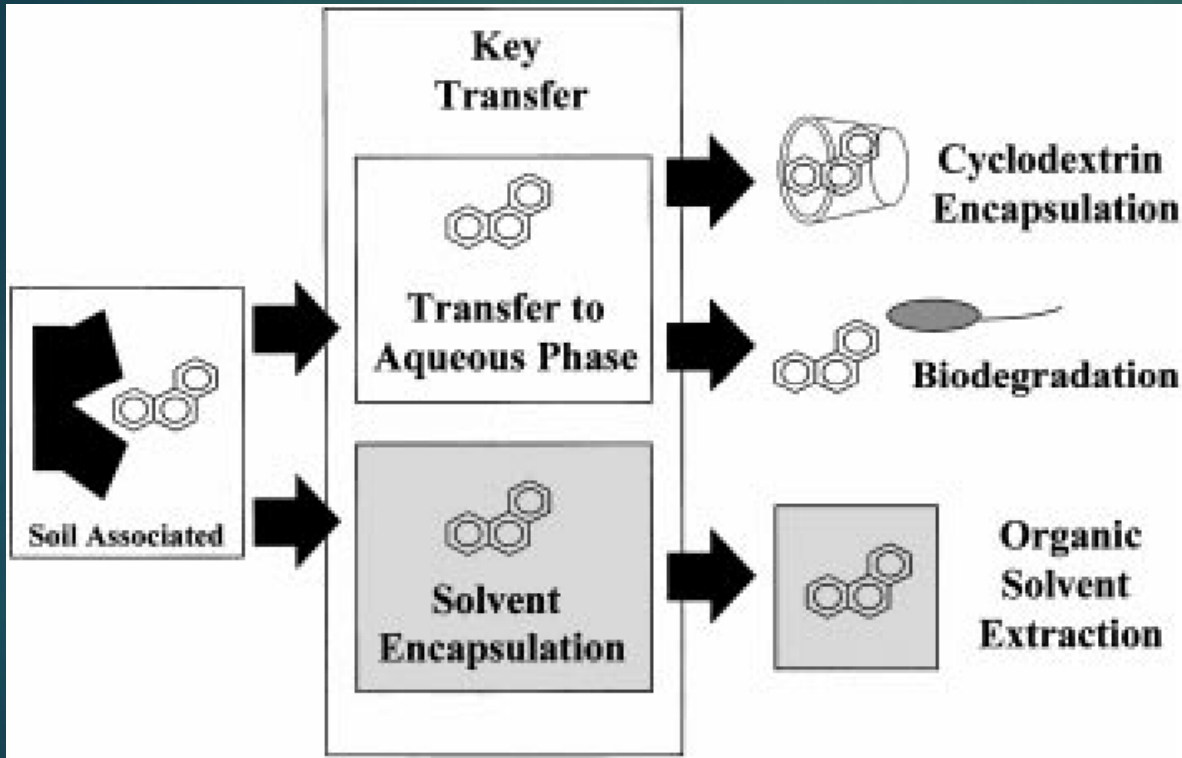

Source: Reid, Jones, Semple, 2013



## Remediation based on risk assessment (Risk-Based Corrective Action – RBCA)

The decision-making process used to assess and take appropriate action against pollution of the groundwater and soil environment, based on the protection of human health and environmental resources. Integrated assessment of the place of pollution and the effectiveness of its remediation.

1. Reduce the risk to humans and the environment at the potential receptor site (e.g. maximum permissible concentrations)
2. Ensure that the evaluation activities focus on collecting only information necessary for making decisions based on risk assessment
3. Ensure that limited resources are concentrated on those polluted areas that present the greatest threat
4. Ensure that the preferred remediation option is the best from the economic point of view and shows a high probability of obtaining a reduction in risk

## Remediation based on risk assessment (RBCA)

101

Tier 1.

Quantitative assessment of the contaminated area based on available data: impact on the environment, potential receptors (e.g. water reservoirs, places of residence, schools), exposure routes (e.g. wells, recreational use of water reservoirs). The most conservative approach is taken, e.g. drinking water in the most polluted place. Deciding whether activities and categorization of areas are required. If action is necessary, then the choice can be made to meet the strictest requirements or go to level 2. Information about the place: use, concentration.

Specification of general (nonspecific for a given location) permissible pollution levels (RBSL – risk-based screening levels) for direct (inhalation of vapours, dust, consumption of water, soil, contact through the skin) and indirect (emission of vapours from the ground, leaching into waters) exposure. Different receptors: residents of different ages, employees, and services removing pollution.

RBSLs are determined for all combinations of chemicals, receptors, routes of exposure and exposure factors (e.g. exposure to carcinogens) to air, water and soil.

If there are exceedances, remediation options are considered or the procedure moves to level 2.

## Remediation based on risk assessment (RBCA)

### Tier 2.

A more specific assessment. Data on site characteristics, monitoring, models for assessment of effects of activity, transport and risk assessment at the exposure place are used. It is possible to recommend monitoring if there is no significant risk. Again, if action is necessary, this can be recommended or the procedure goes to level 3.

The permissible levels for a given location (SSTL – site-specific target levels) are calculated: in the source zone, at the exposure point (taking into account the natural attenuation factor: empirical, analytical models, from the field data), for mixed pollution.

Location data is required, including: size of the pollution zone; groundwater gradient, permeability, etc.; climatic conditions; soil data, porosity, layer thickness, soil type; presence of electron acceptors; predicted receptor types and their location; etc.

## Remediation based on risk assessment (RBCA)

### Tier 3.

Intensive use of modeling (simulation) techniques, the evaluation is aimed entirely at the specificity of the area.

Exposure and risk assessment is for existing conditions instead of using simplified scenarios. Very detailed data on transport risk and pollution type is required.

MODFLOW – package for modeling groundwater flow developed by the US Geological Survey, free – the model itself; a number of commercial and free graphic interfaces

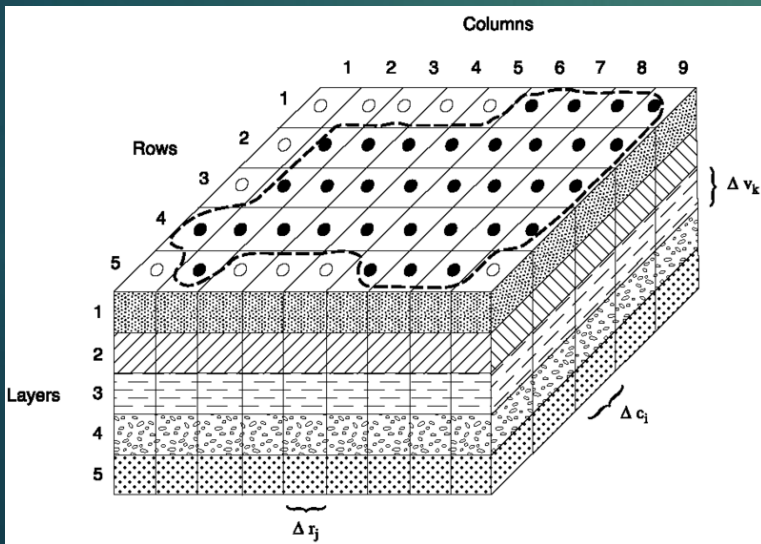

Source: Harbaugh, 2005

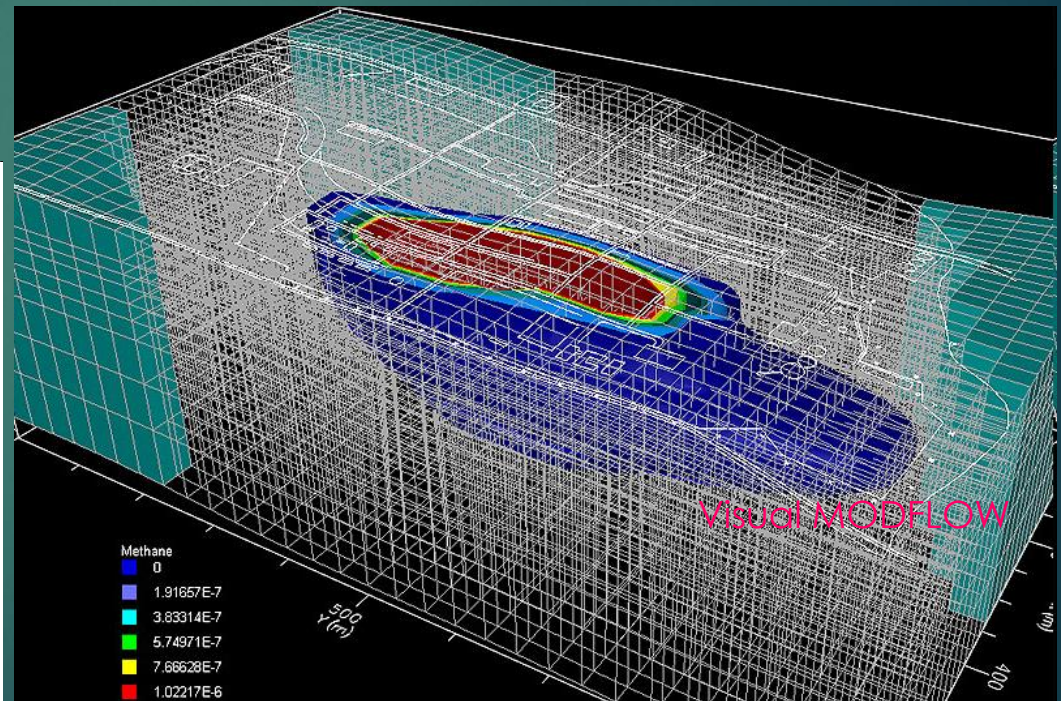

Source: www.delphitech.kz



RT3D – uses the results of the MODFLOW simulation

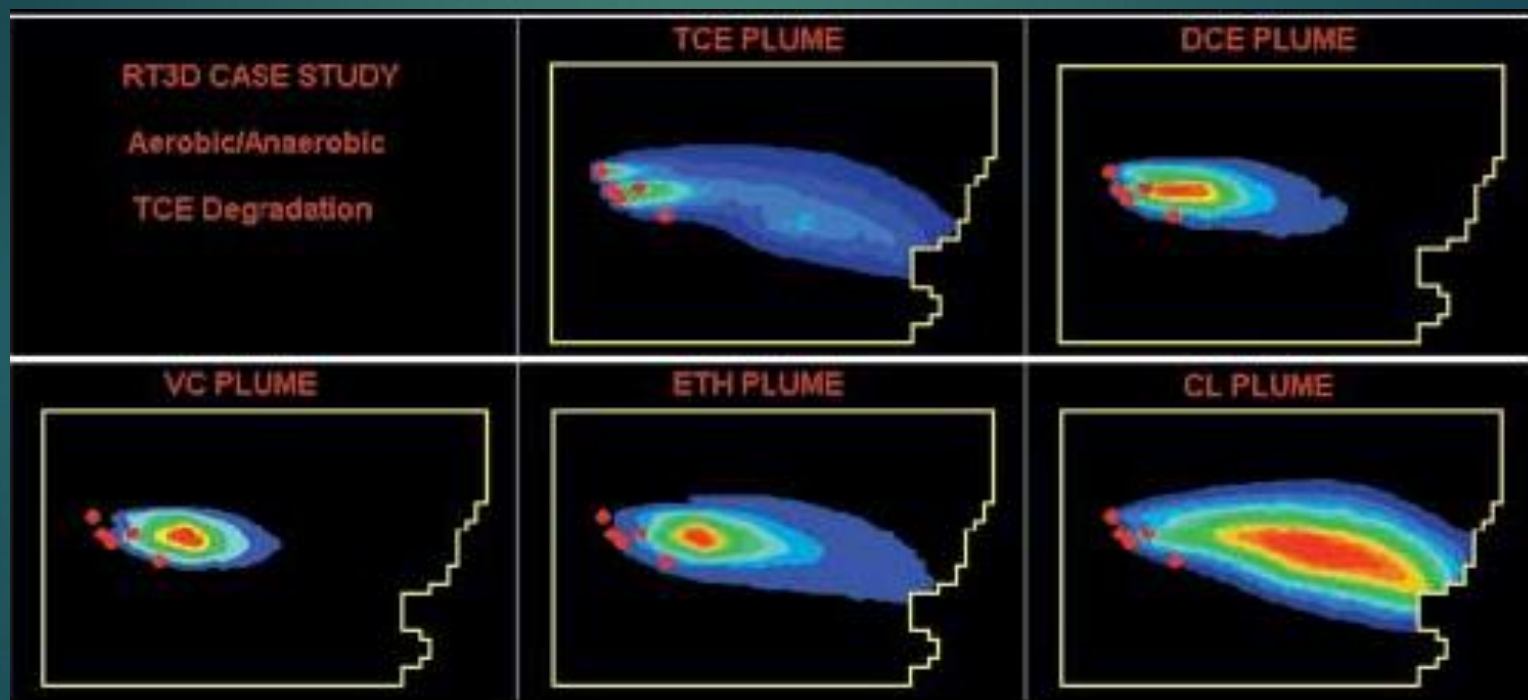

GMS – Aquaveo

Part 3

# Methods of remediation of soil and groundwater



# Methods of remediation of soil and groundwater – decision scheme

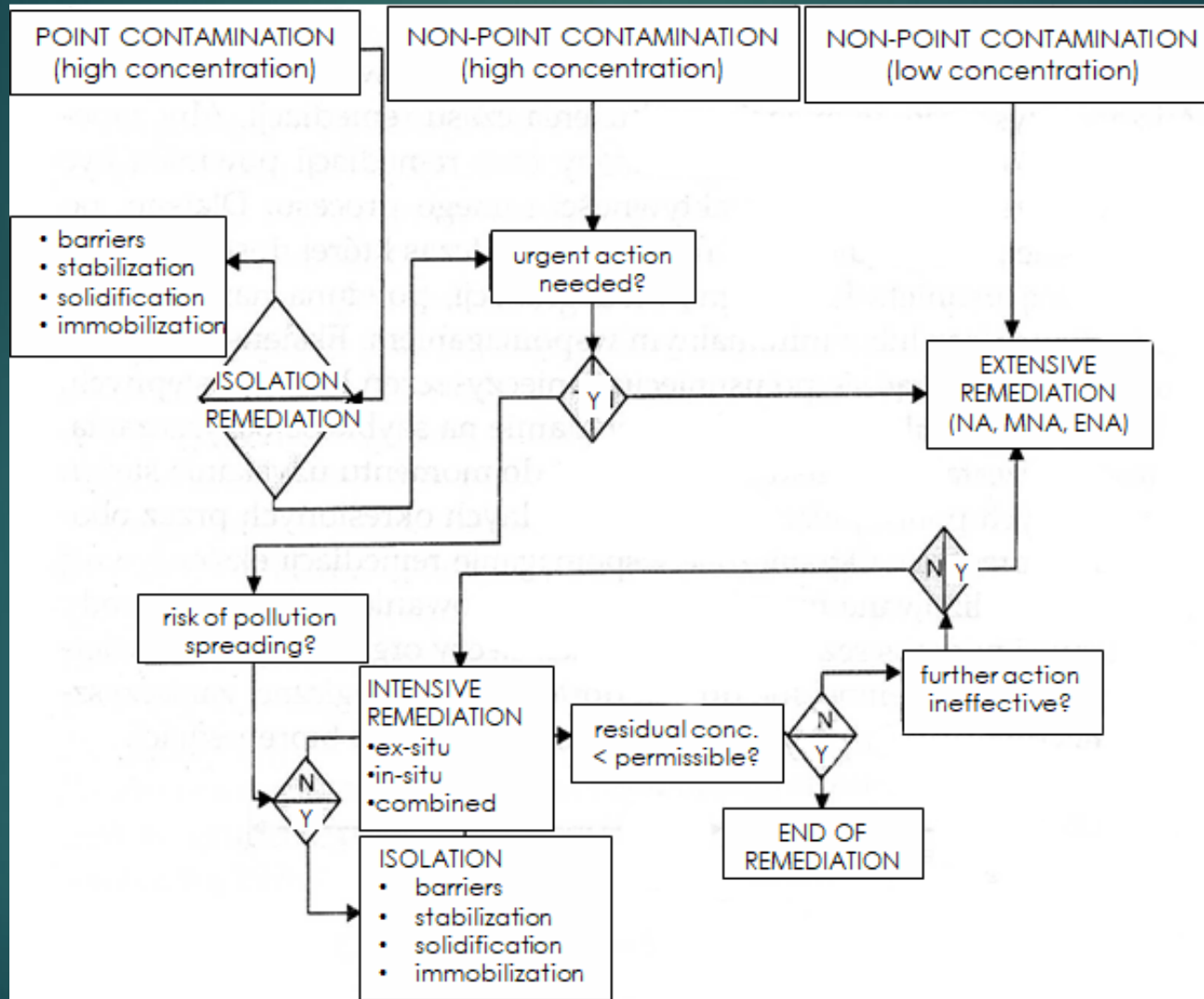

## Methods of remediation of soil and groundwater

1. Limiting contamination spreading: barriers, immobilization of pollutants, etc.
2. Elimination of contamination sources; primary and secondary sources: by physical methods (e.g. dig and dump, LNAPL skimming, etc.)
3. Intensive remediation (in-situ, ex-situ, on-site; off-site):
  - a. physical (pump-and-treat, vapor extraction...)
  - b. chemical (oxidation, reduction...)
  - c. biological (bioremediation)
4. Natural attenuation (monitored, enhanced...)

## Limiting contamination spreading

- physical barriers: impermeable barriers (cutoff walls), cement and slurry barriers
- hydraulic barriers
- physical-hydraulic barriers
- permeable reactive barriers (sorbing, with metallic iron, biological, multibarriers)
- immobilization of contaminants (organic and inorganic – mostly metals)

## Cutoff walls

110

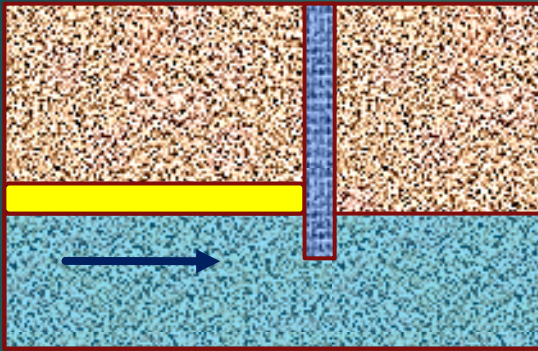

“hanging” barrier (LNAPL)

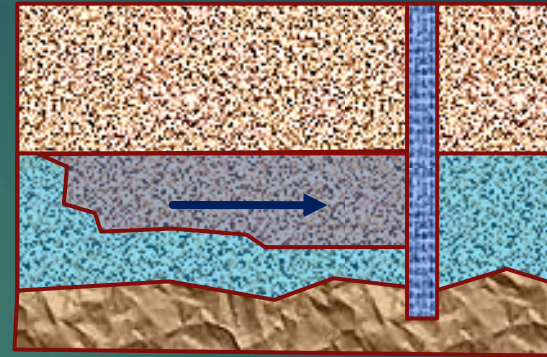

full barrier (dissolved pollutants)

## Slurry walls

Made of materials of low filtration coefficient: clay, bentonite, cement, or HDPE foils (geomembranes). Addition of fly ash for increasing the sorption capacity.

Performing as a narrow (0.6-0.9 m) trench with a depth of up to 25 m, and sometimes even 50 m. Walls reinforced with bentonite slurry, then trench is filled with e.g. a ground-bentonite mixture ( $k = 0.5 * 10^{-10}$  m/s).

In weak soils, injecting (pumping) bentonite slurry or cement directly into the ground.



Source: Marchiori, Li, Evans, 2019

trench excavation

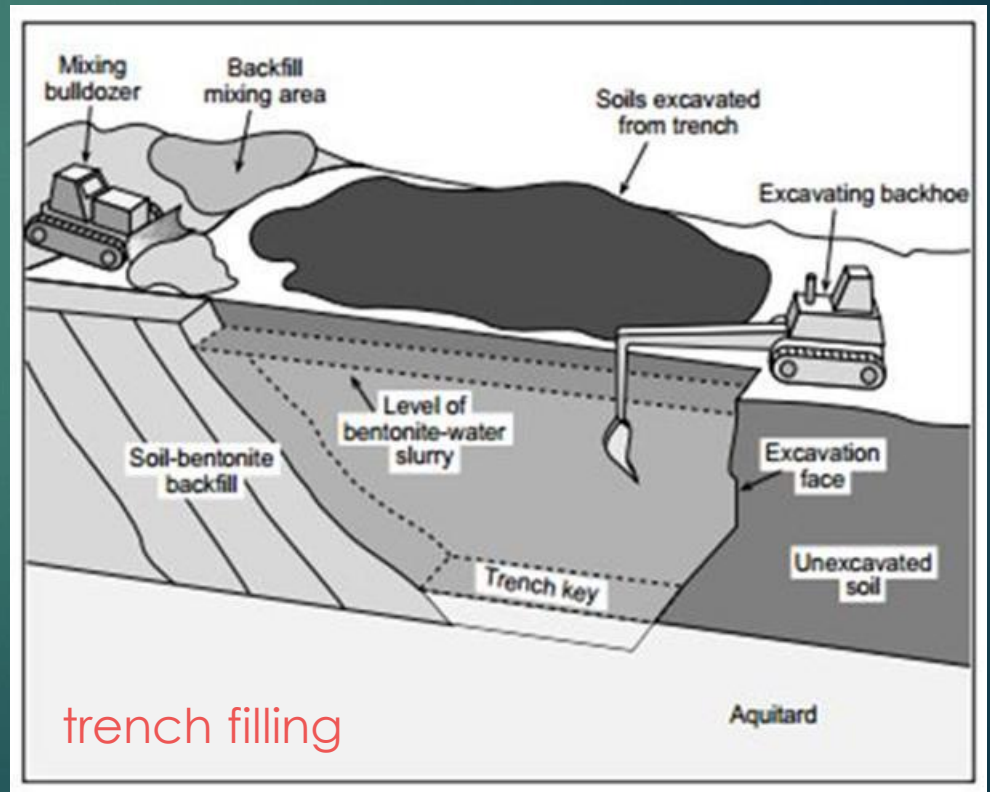

## Sheet pile, e.g. "Waterloo Barrier"

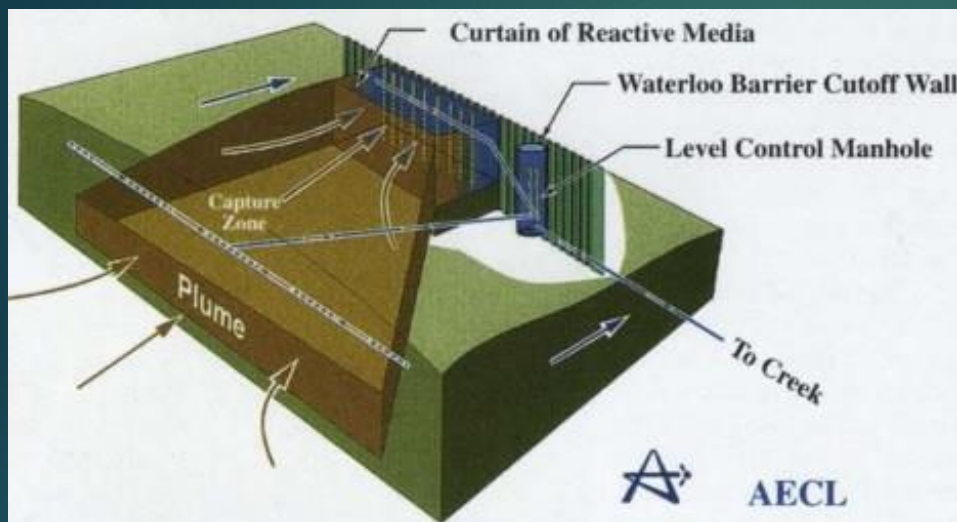

Source: <http://www.waterloo-barrier.com>

Barrier depth up to 15 m. Hydraulic conductivity  $10^{-8}$ – $10^{-10}$  cm/s.  
 Joints sealing based on clay, cement, polymers, etc.  
 Fast construction, but sensitive to corrosion, weak points on joints, etc.



# Geomembranes as cutoff walls

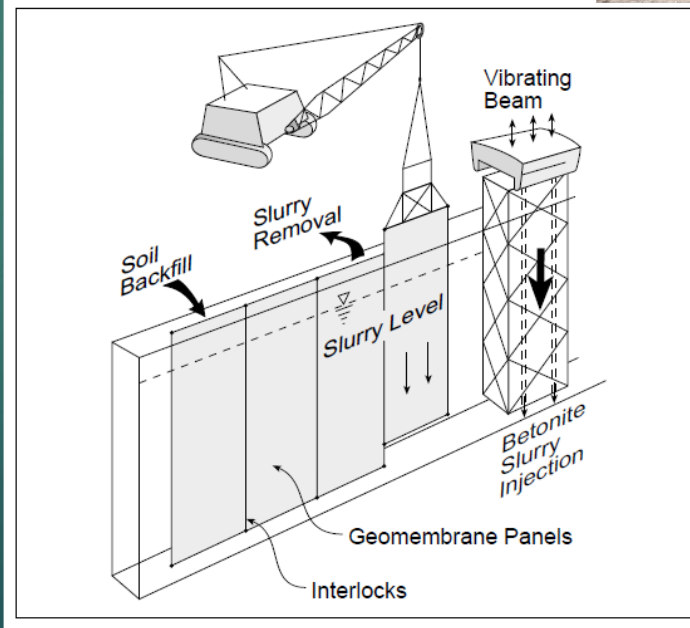
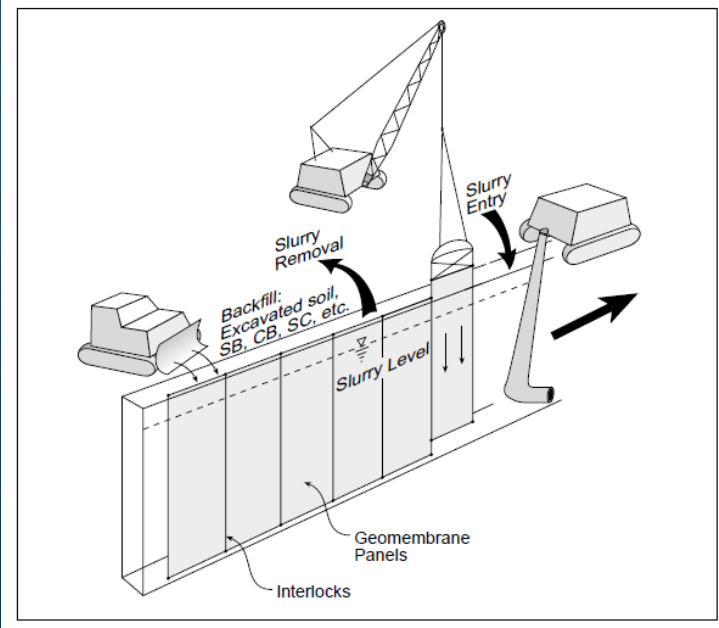
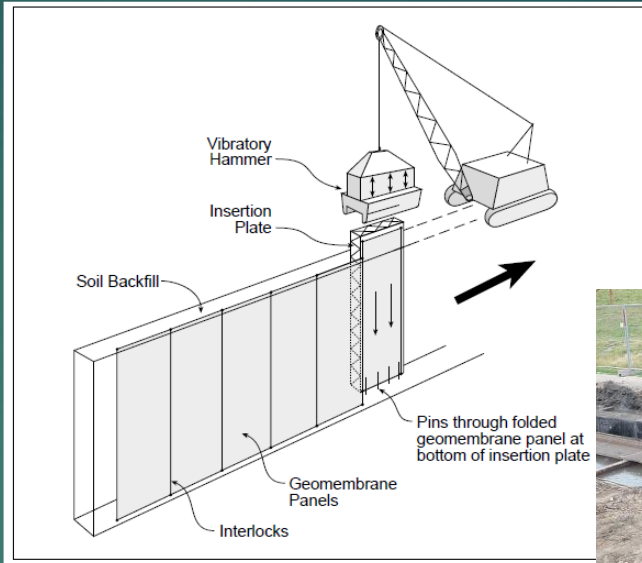
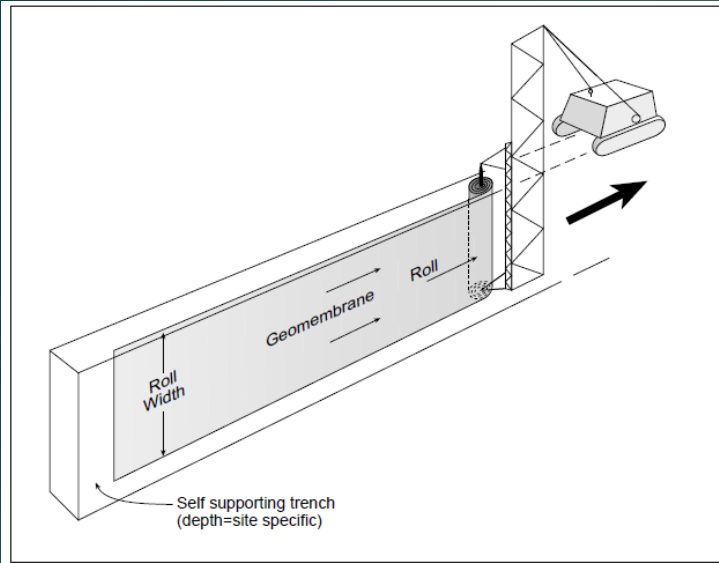

Sources: [www.clu+in.org](http://www.clu+in.org)  
O'Donnell, Rumer, Mitchell, 1995  
<https://cofra.com>

# Hydraulic barriers

Sets of wells, drains, ditches controlling the pollution spreading by creating hydraulic depression (and pumping out contaminated waters with the possibility of their treatment – the "pump-and-treat" method).

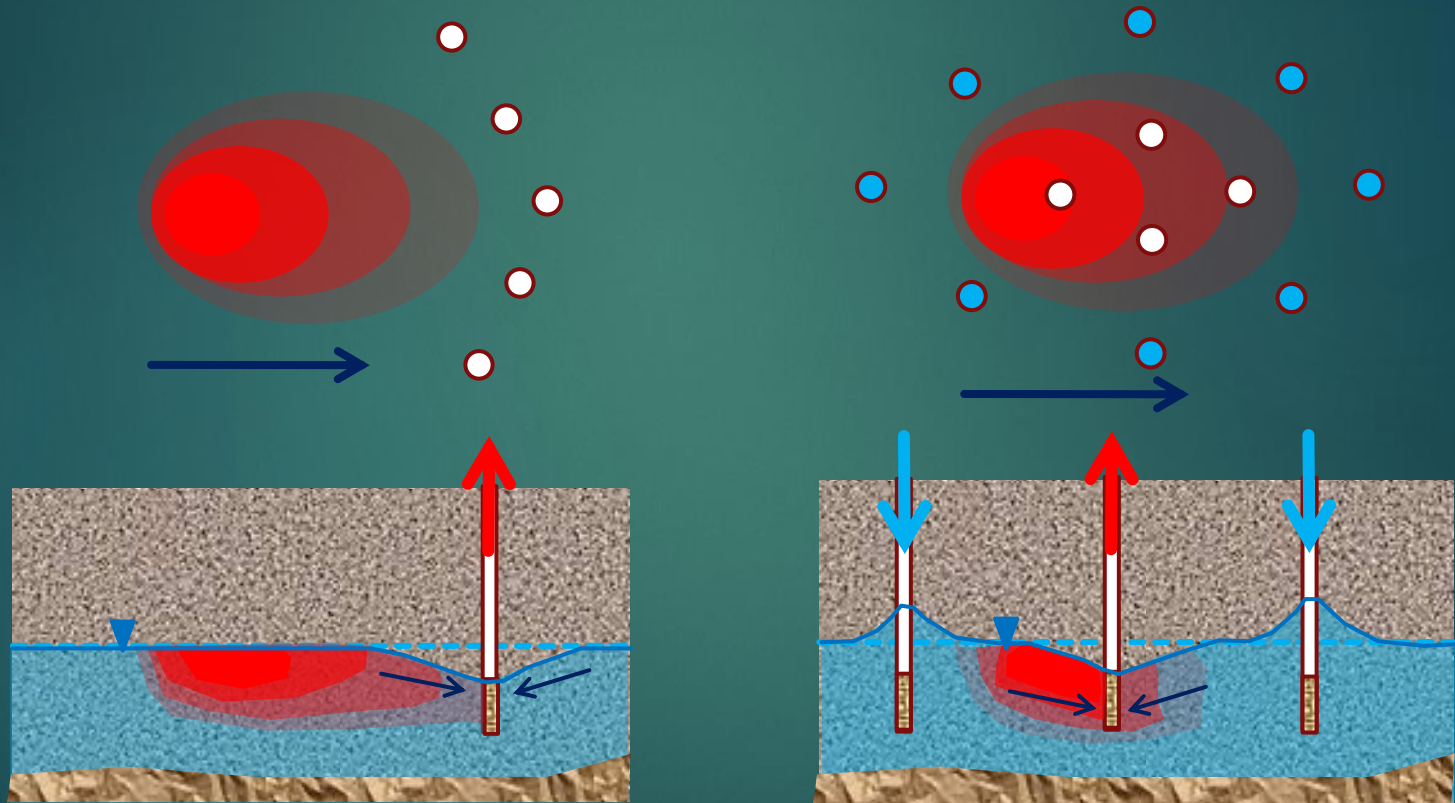

barrier of extraction wells

set of extraction and pumping wells

S2 - Potential scenario at Tarnowskie Góry megasite - groundwater remediation

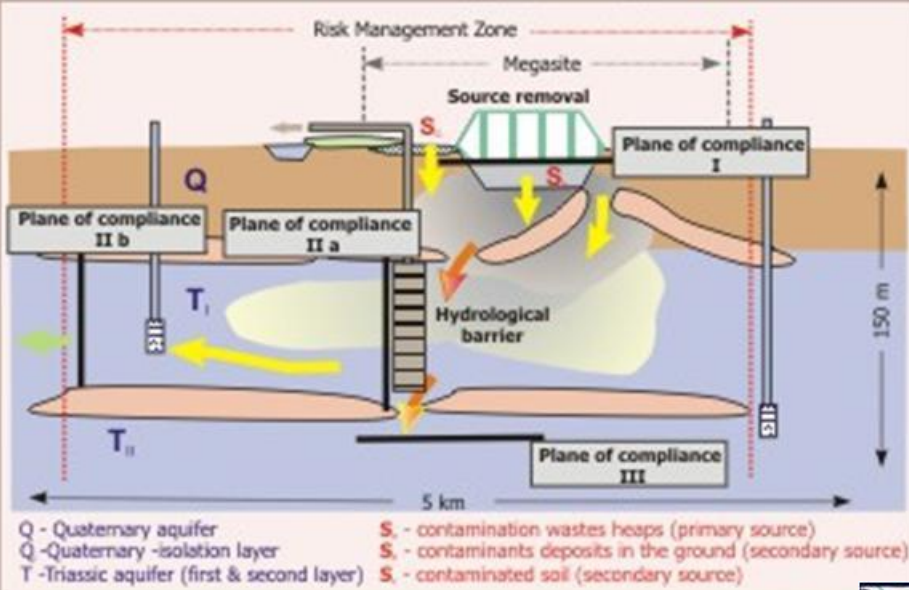

Integrated Management Strategy for Risk Reduction of Groundwater Contamination at Tarnowskie Góry Megasite  
 Janusz Krupanek  
 Institute for Ecology of Industrial Areas  
 Katowice, Poland

Project WELCOME

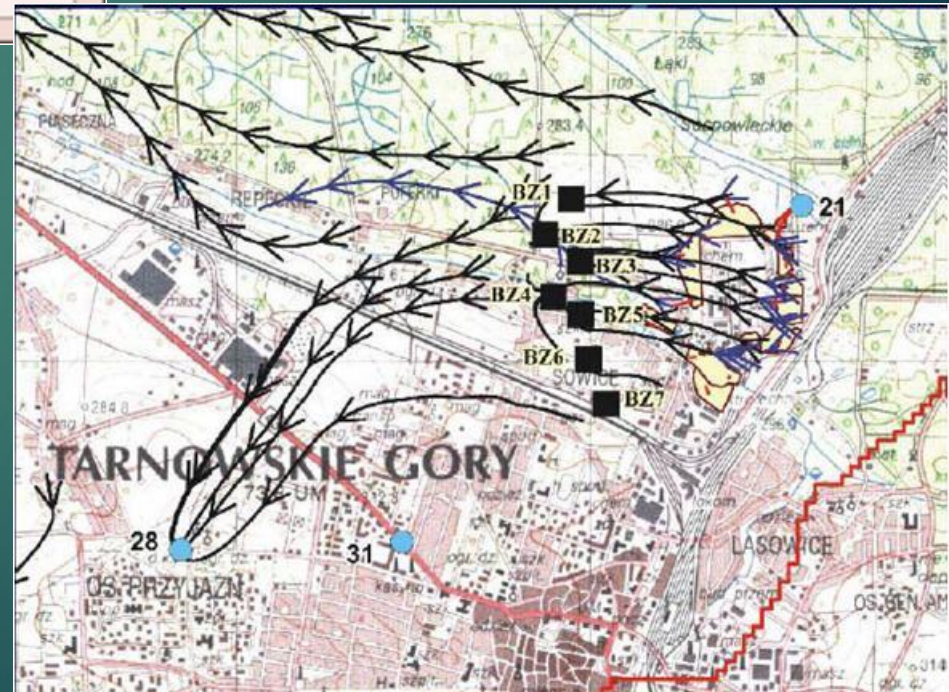

# Hydraulic-physical barriers

Combination of physical and hydraulic barriers. This limits pollution spread and controls hydrogeological conditions in the area.

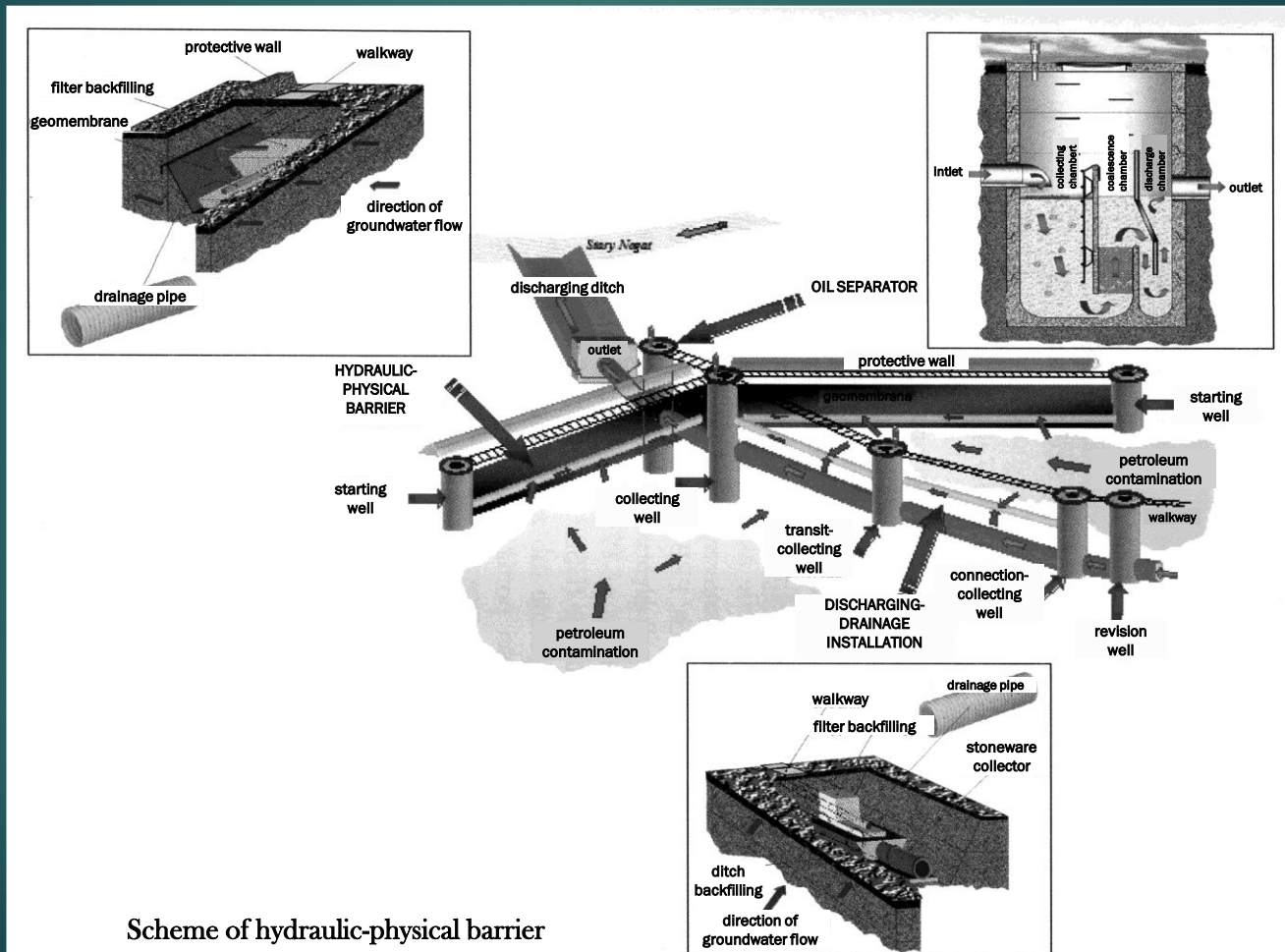

Scheme of hydraulic-physical barrier



[www.hydrogeotechnika.pl](http://www.hydrogeotechnika.pl)

Barriers filled with material purifying groundwater flowing through, by immobilization (e.g. adsorption) or/and degradation of pollutants. Without or limited impoundment of groundwater.

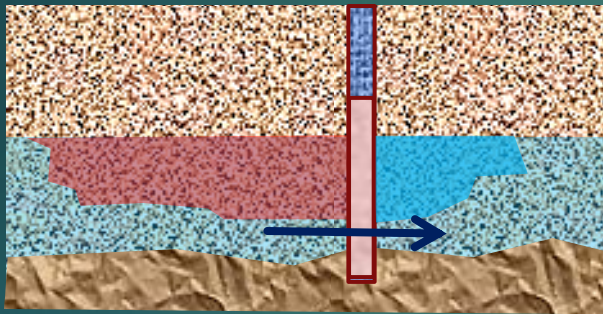

vertical barrier

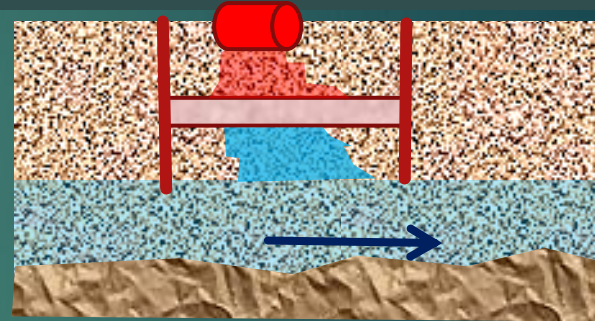

horizontal barrier

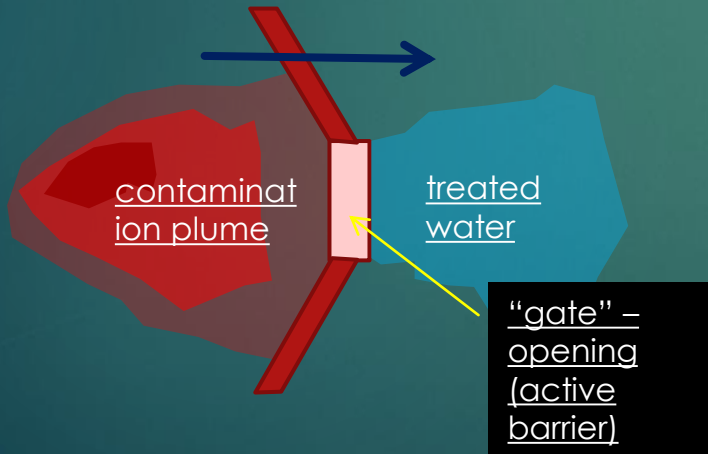

"funnel and gate"

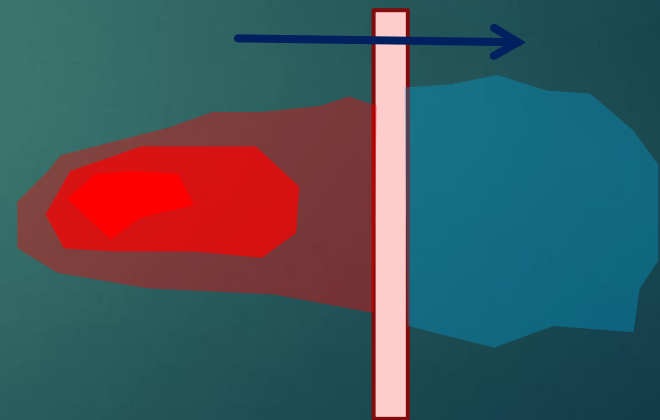

continuous barrier

Filling	Contaminants treated
granulated metallic iron	chlorinated hydrocarbons, some heavy metals
activated carbon	chlorinated hydrocarbons (incl. volatile), PAHs, pesticides, heavy metals
zeolites	heavy metals
ion-exchange resins	heavy metals
fly ash	heavy metals

## Metallic iron Fe<sup>0</sup>

Iron corrosion, with transfer of electrons – reduction of chlorinated compounds:

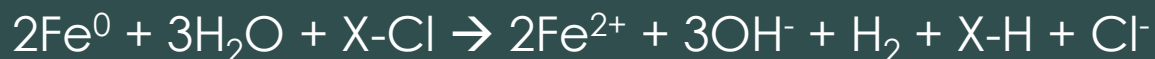

High redox potential of couple Fe(II)/Fe(0) -0,447 V

Applied for removal of:

- tetrachloroethylene and its metabolites
- tetrachloromethane
- chromium.

Enhancement of effectiveness by application of catalyst, e.g. palladium (Pd).

Efficiency of removal depends on specific surface area – typically granules.



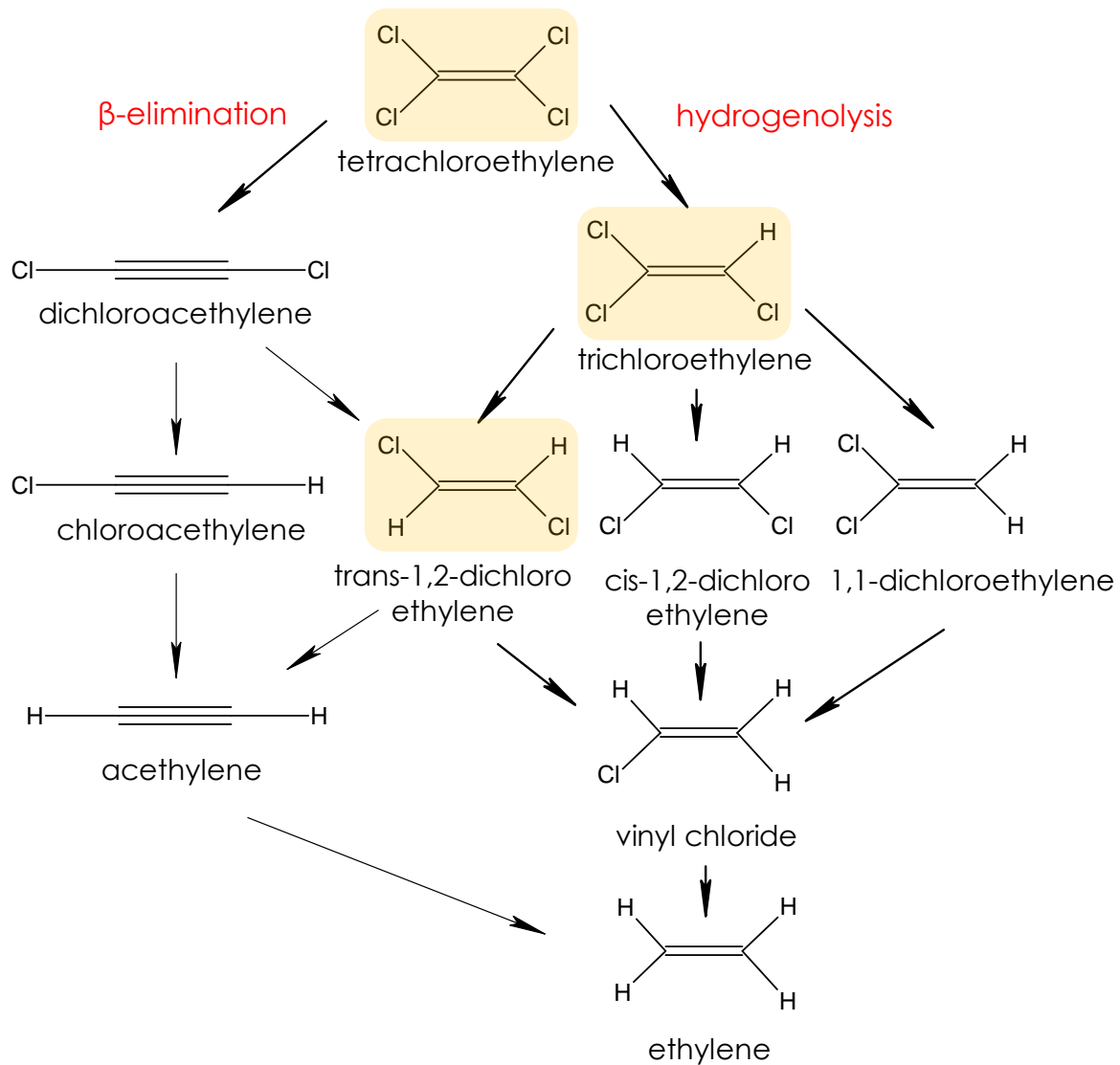

### Limited lifetime of iron filling as a result of:

- consumption: reactions with target substances (e.g. PCE) and side reactions (oxygen, nitrate, sulphate):



Passivation – covering the surface with minerals (e.g. magnetite), making iron non-reactive.

### Possibility of chromium Cr<sup>6+</sup> removal (precipitation as Cr<sup>3+</sup>)



Precipitation of Cr(OH)<sub>3</sub>; hydroxide Cr<sup>3+</sup>/Fe<sup>3+</sup> or (oxi)hydroxide Cr<sup>3+</sup>/Fe<sup>3+</sup>

Effectiveness – reduction from 1–3 mg/l to 0.01 mg/l

Also, removal of arsenic As by immobilization as a result of precipitation of minerals (research stage).

# Permeable reactive barriers with metallic iron – examples

123

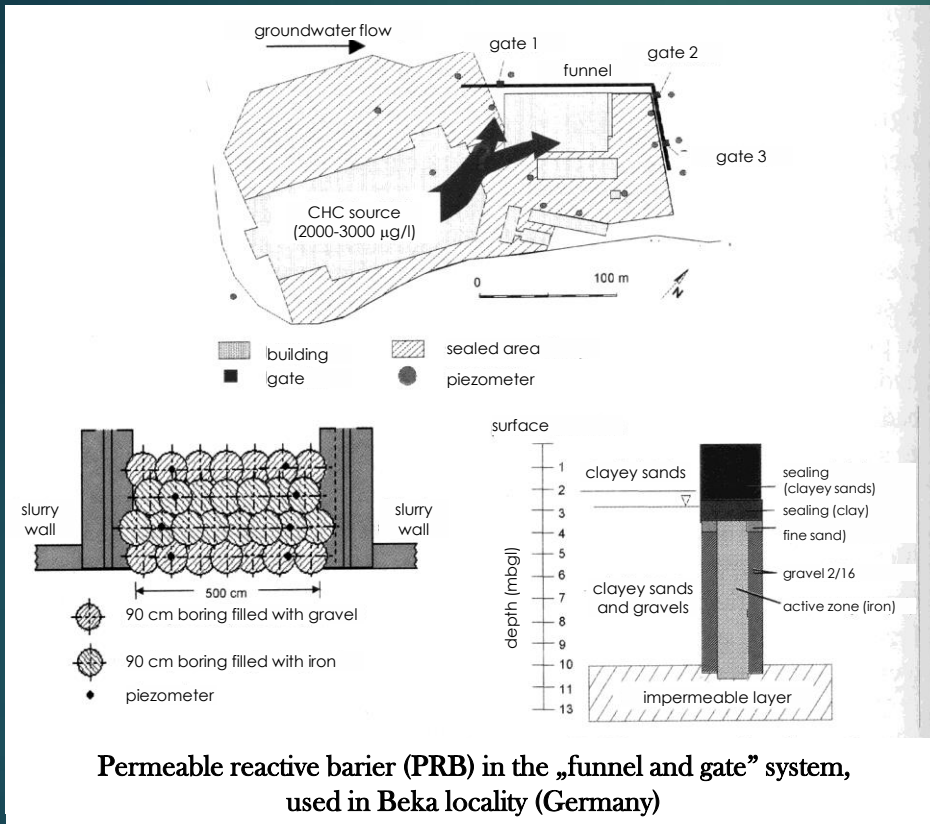

gate depth 6 m  
 flow velocity 6 cm/d  
 aeration 6 × 20 min daily, filled with plastic balls

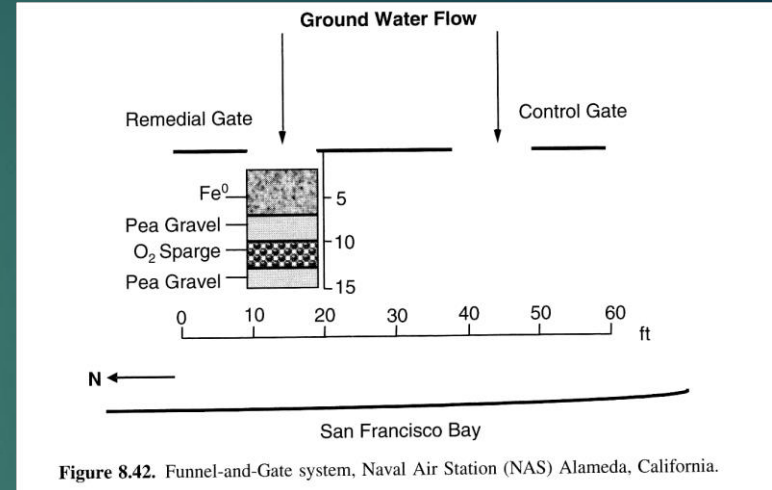

**Table 8.18. Percent Removal of Chlorinated Contaminants in Granular Iron Wall, NAS Alameda, California**

Contaminant	Influent Mass (mg)	Effluent Mass (mg)	Mass Removed (%)
TCE	107,500	278	99.7
1,1-DCE	3595	137	96.1
cis-DCE	1,347,000	116,500	91.3
trans-DCE	2997	66	97.8
VC	571,900	37,180	93.5

**Table 8.19. Estimates of Percent Removal of cis-DCE and VC by Biodegradation and Volatilization Within Biosparge Zone, NAS Alameda, California**

Contaminant/Process	Influent Mass (mg)	Effluent Mass (mg)	Mass Removed (%)
cis-DCE			
Biodegradation	142	58.05	59
Volatilization	142	93.57	34
Actual total removal	142	47.91	66
VC			
Biodegradation	283	216.20	24
Volatilization	283	108.88	62
Actual total removal	283	97.31	66

## Methods of PRB construction (depths)



Unsupported trench  
(20 ft, 6 m)



Support type:  
trench-box (20 ft, 6 m)



Continuous excavator  
(35 ft, 11 m)



Cofferdam  
(30 ft, 9 m)



## Methods of PRB construction (depths)



Trench supported with liquid polymer (70 ft, 21 m)



Soil mixing (40 ft, 12 m)



Injection techniques (60 ft, 18 m)

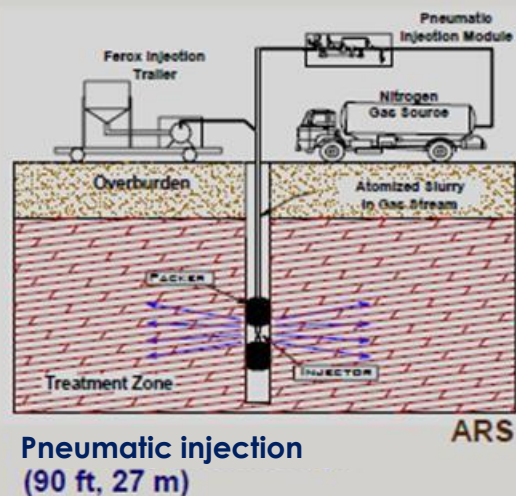
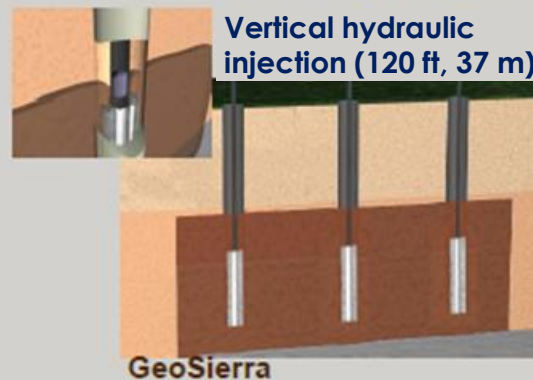

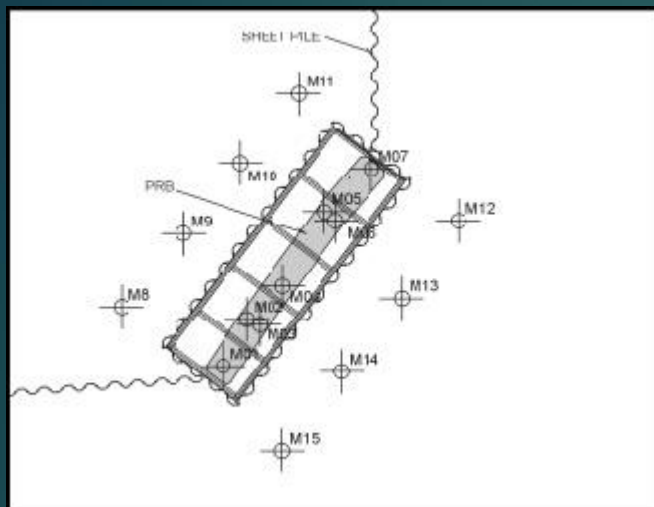

Source: <http://www.rtdf.org>

Vapokon Petrochemical Works, Sønderlø, Denmark. PCE, TCE, DCE, DCA, DCM, BTEX – up to 5,000  $\mu\text{g/l}$ .  
 Funnel (120 m) and gate (15 × 9 × 0.6 m), filled with 75 m<sup>3</sup> Fe (0). Additional drainage to lower groundwater flow velocity and post treatment of groundwater by wall (activated carbon).  
 Lowering concentration below 10  $\mu\text{g/l}$ , plus likely biological reactions.

Karlsruhe, area of former gasworks

Contamination by PAHs, BTEX – plume width 200 m,  
length 400 m

Barrier width 240 m, depth 17 m (16 m bgl impermeable layer)  
– sheet pile wall

8 “gates” with granulated activated carbon, total 150 ton.  
Pre-fabricated construction of 1.8 m diameter and 18 m length

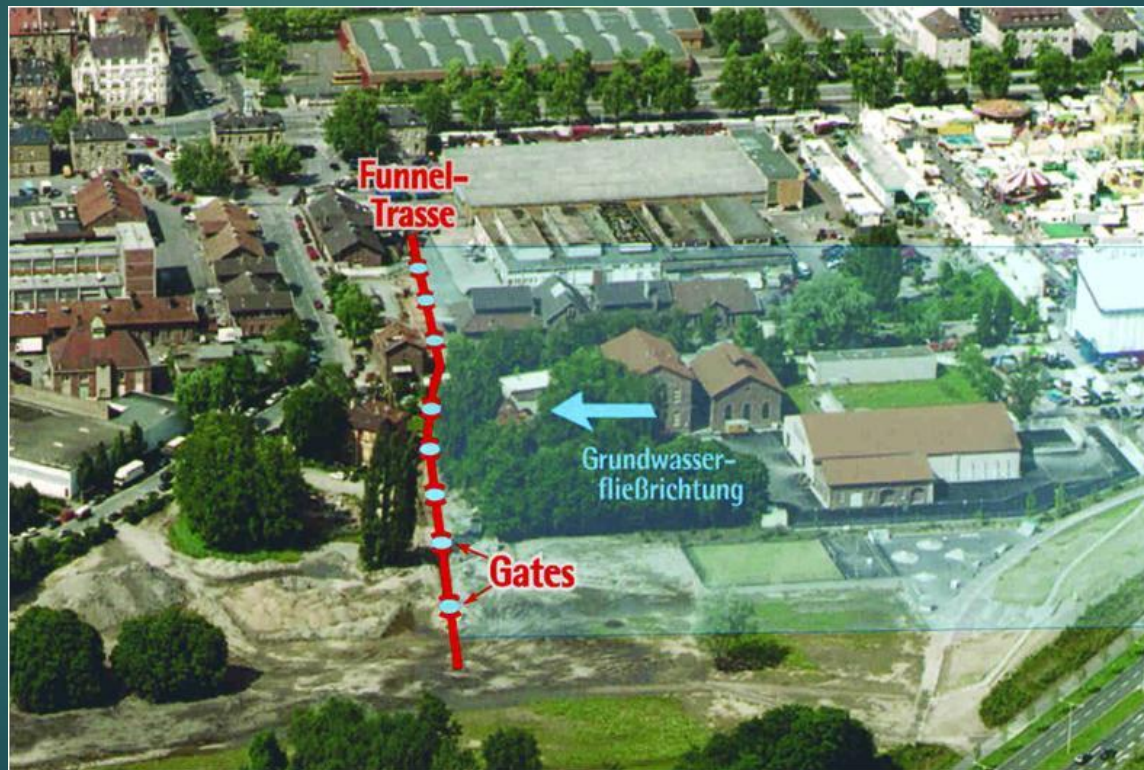





Filling	Contaminants treated
Nutrients(N, P...)	hydrocarbons (petroleum-like)
Microorganisms (biological film)	
Oxygen carriers (oxygen releasing compounds)	
Mulch (wood cuttings and chips, agricultural waste...)	chlorinated hydrocarbons (TCE, DCE), explosives, other
Compost	



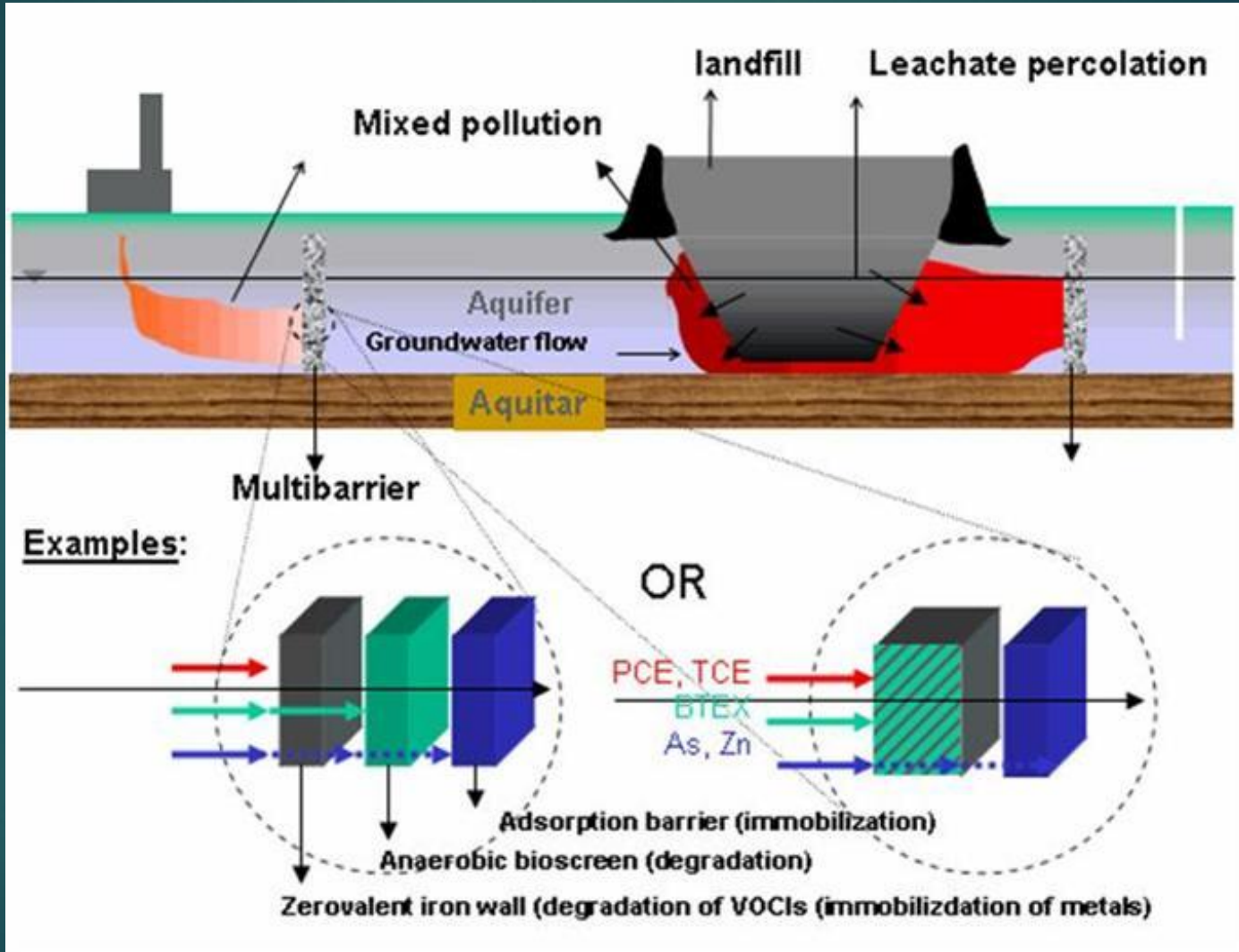

Hooge Maey landfill (Flanders, BE):  
 municipal and industrial waste  
 Leachates contain ammonium  
 nitrogen, chloroorganic compounds  
 and other organic compounds

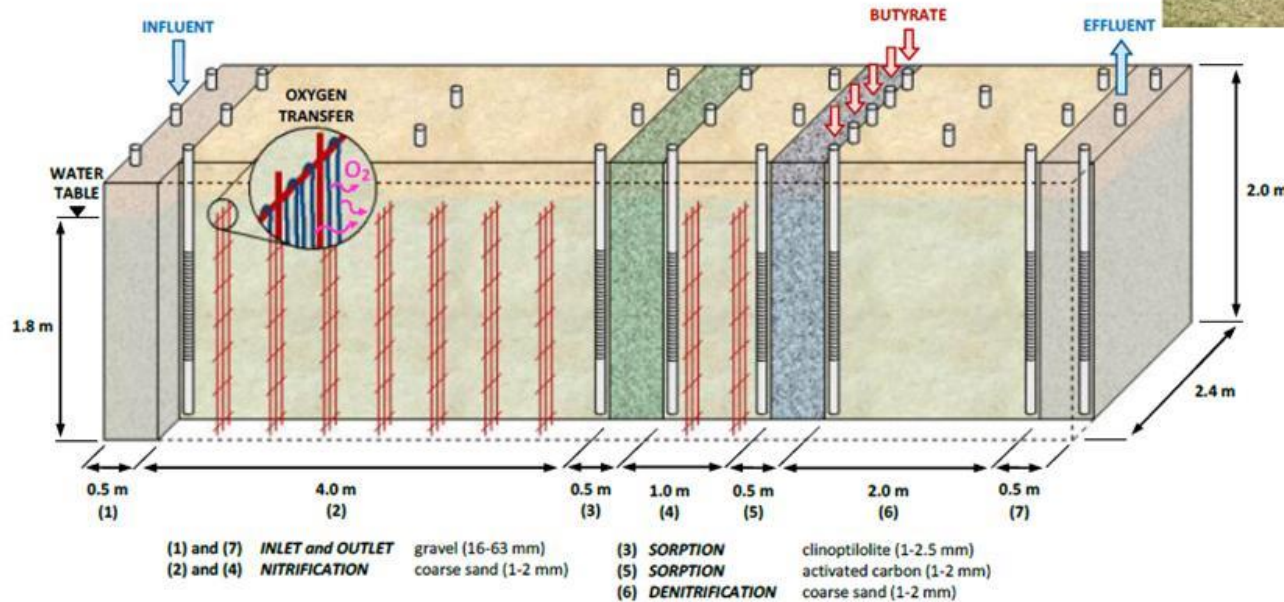
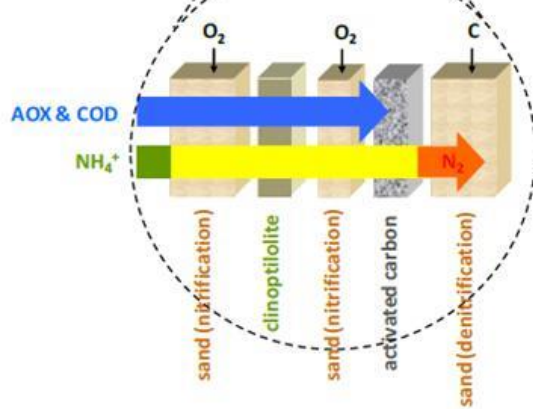
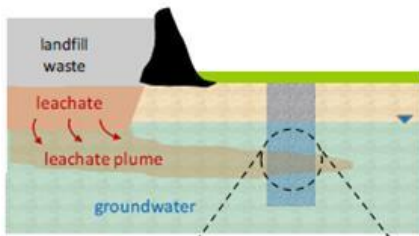

Source: [www.multibarrier.vito.be](http://www.multibarrier.vito.be)

## Immobilization of contaminants: reduction of their mobility

- solidification – binding using a binder, making a solid block
- stabilization – decreasing solubility of contaminants
- vitrification – melting of soil in a glass-like substance
- increasing of sorption capacity of soil (organic amendments)

### Metals, but not only (excluding volatile organics)

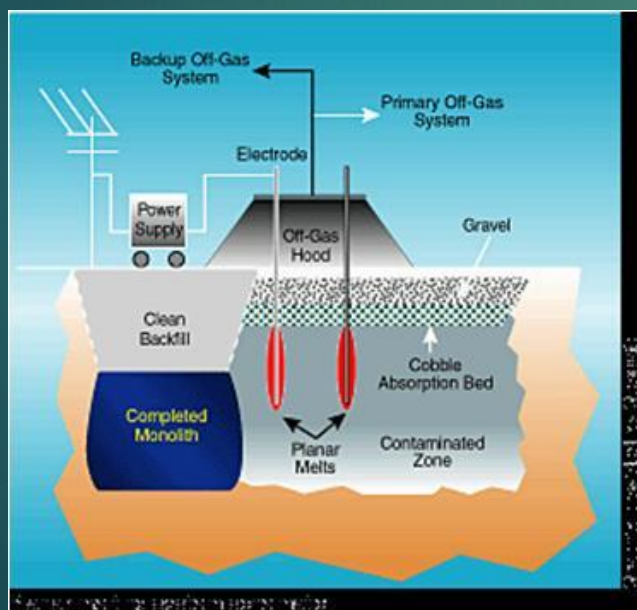

Source: [http://infohouse.p2ric.org/ref/14/0\\_initiatives/init/fall99/newangl.htm](http://infohouse.p2ric.org/ref/14/0_initiatives/init/fall99/newangl.htm)

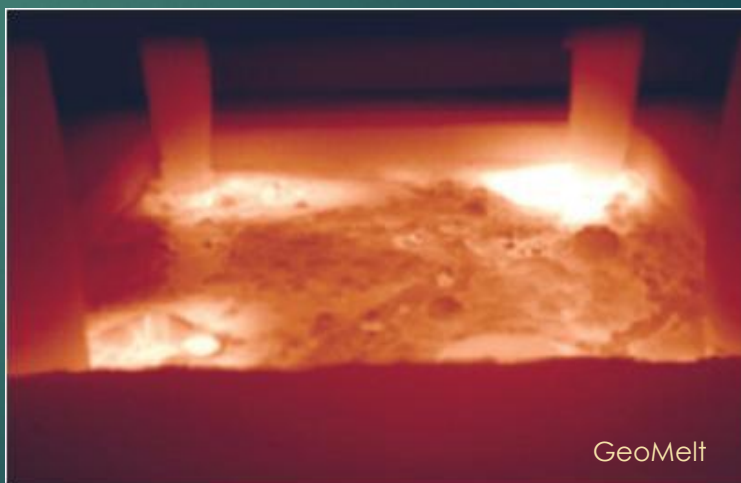

Source: [www.nuclearsolutions.veolia.com](http://www.nuclearsolutions.veolia.com)

# Solidification

in- and ex-situ

Binders: inorganic: cement, lime, fly ash...; organic: asphalt, epoxides, polyesters...; mixed

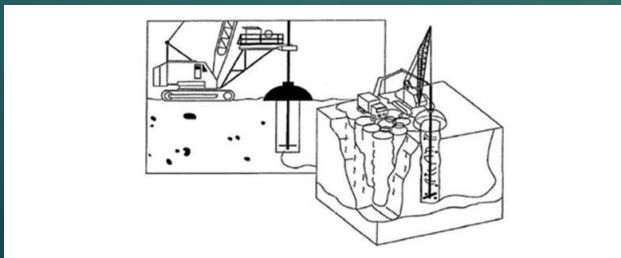
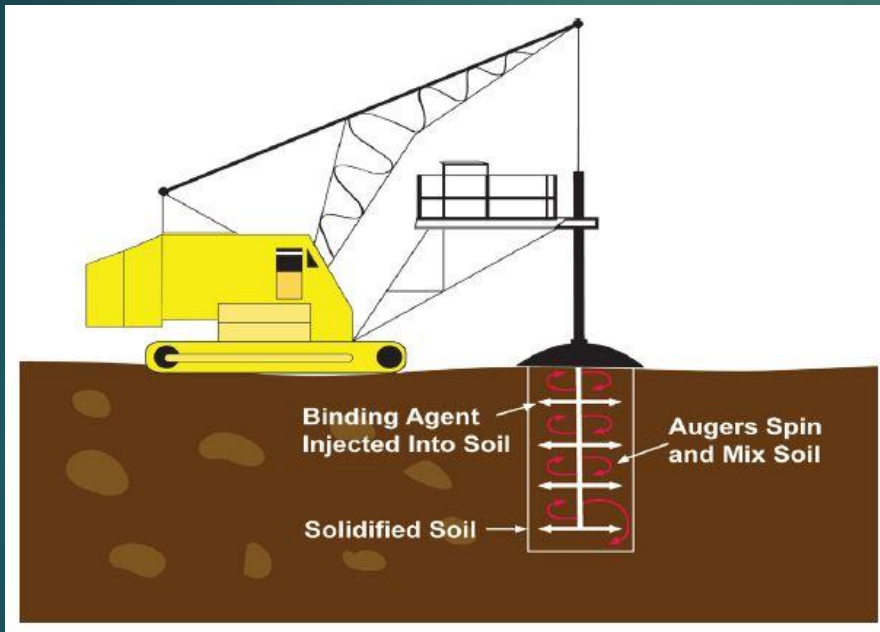

## Immobilization of heavy metals:

- increasing the sorption capacity: adding organic matter (ion exchange sorption, complexing...): natural fertilizers (manure, slurry), post-harvest residues, sewage sludge, etc. Also sorbents: black carbon, activated carbon, zeolites...
- biostabilization and biosorption: binding by plant roots, sorption by biomass, living or dead (algae, bacterial cells)
- precipitation, biological or chemical

## Immobilization of heavy metals – precipitation:

Precipitation as hydroxides or sulphides:  $\text{Cu}^{2+}$ ,  $\text{Cu}^+$ ,  $\text{Ni}^{2+}$ ,  $\text{Pb}^{2+}$ ,  $\text{Hg}^{2+}$ ,  $\text{Cd}^{2+}$ ,  $\text{Zn}^{2+}$

Precipitation as hydroxide:  $\text{Cr}^{6+}$

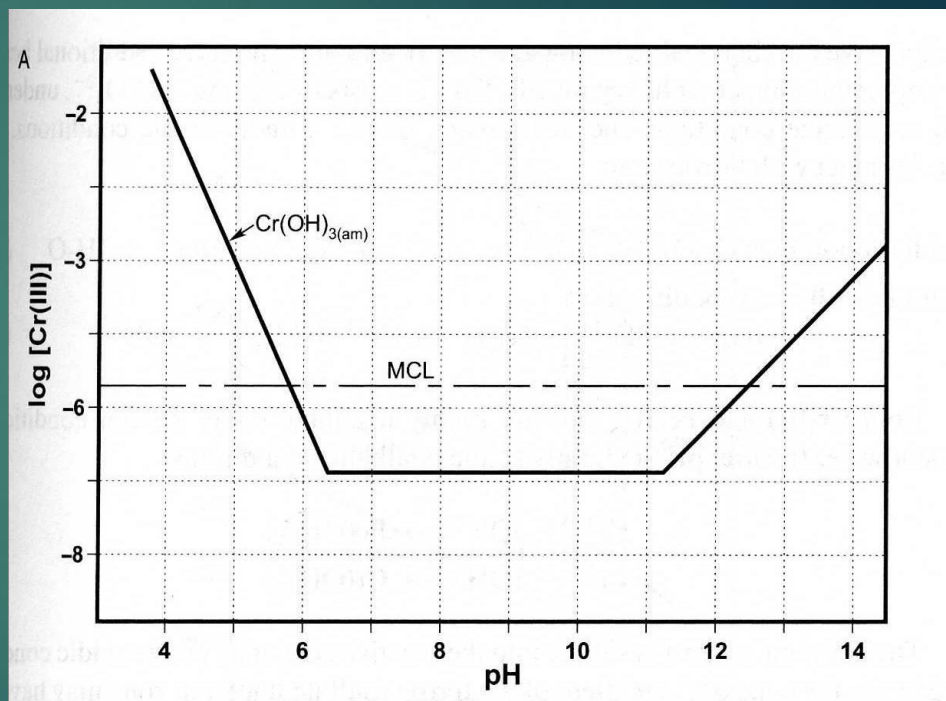
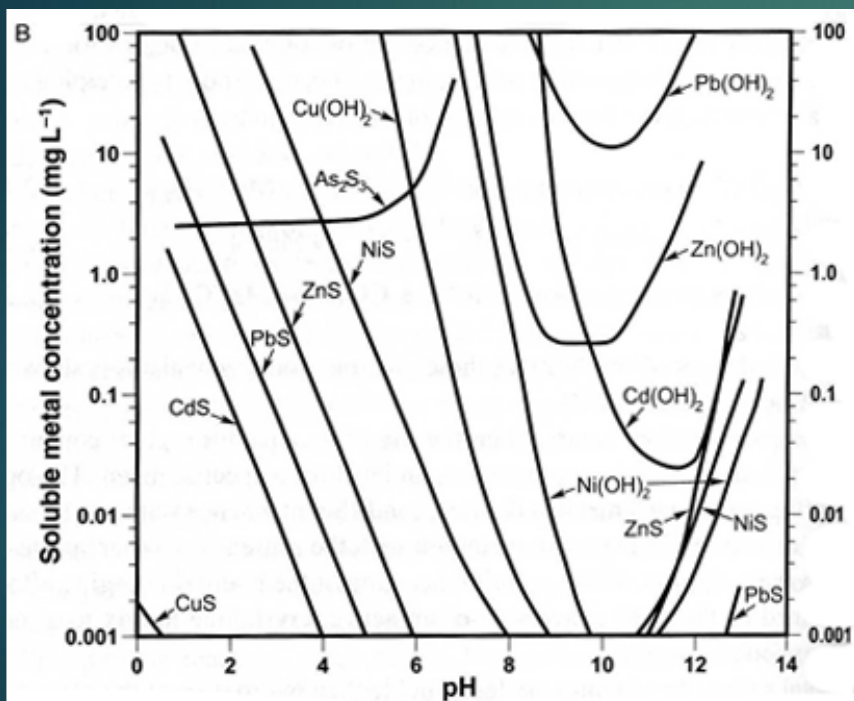

Suthersan, Payne. In situ remediation engineering, CRC Press

Precipitation of hydroxides: application of  $\text{Ca}(\text{OH})_2$  or  $\text{KOH}$  (e.g. by injection). However: pH changes (alkalinization); possible increase of solubility as a result of pH changes (decrease of pH).

## Immobilization of heavy metals – precipitation:

Precipitation as sulphides:

Chemical: application of sodium sulphite or calcium polysulphite

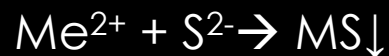

Sulphite ion  $\text{S}^{2-}$  in aerobic conditions is rapidly oxygenated to sulphate ion  $\text{SO}_4^{2-}$ . For this reason, it is necessary to create a reducing zone by oxygen consumption, e.g. by adding an easily degradable organic substrate (e.g., carbohydrates). Microorganisms will then quickly consume oxygen.



## Immobilization of heavy metals – precipitation:

### Biological:

stimulation of the activity of sulphate-reducing microorganisms (SRB)



Stimulation of SRB growth by the addition of easily degradable substrate (various, e.g. molasses, lactates, lactate polymers), when sulphates occur in groundwater (in theory: 3 mg  $\text{SO}_4^{2-}$  gives 1 mg of  $\text{S}^{2-}$ ).

Sulphate reduction causes an additional increase of pH:

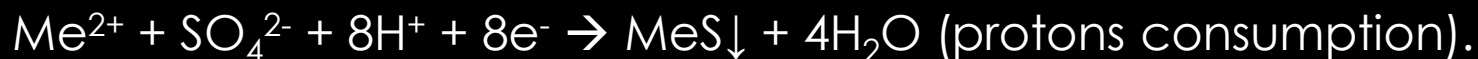

It is accompanied by precipitation of hydroxides:



## Immobilization of heavy metals – precipitation of chromium Cr

Chromium: occurs as  $\text{Cr}^{6+}$  ( $\text{CrO}_4^{2-}$  or  $\text{Cr}_2\text{O}_7^{2-}$ ) or  $\text{Cr}^{3+}$ .

Two-stage process: 1) reduction of  $\text{Cr}^{6+}$  to  $\text{Cr}^{3+}$ , 2) precipitation of  $\text{Cr}^{3+}$  as hydroxides.

Reduction of  $\text{Cr}^{6+}$  abiotically (e.g.  $\text{Fe}^{2+}$ , injections of ferrous sulphate etc.) or microbologically (a number of facultative anaerobic bacteria): injection of easily biodegradable substrate (e.g. diluted molasses).

Mechanisms of biological reactions: a)  $\text{Cr}^{6+}$  as electron acceptor, b) reduction of  $\text{Cr}^{6+}$  by products of sulphate reduction, c) reduction of  $\text{Cr}^{6+}$  by organic components of soil (e.g. fulvic and humic acids).

Precipitation of hydroxide: conditions from alkaline to mildly acid (little probability of reoxidation of  $\text{Cr}^{3+}$  in normal conditions).

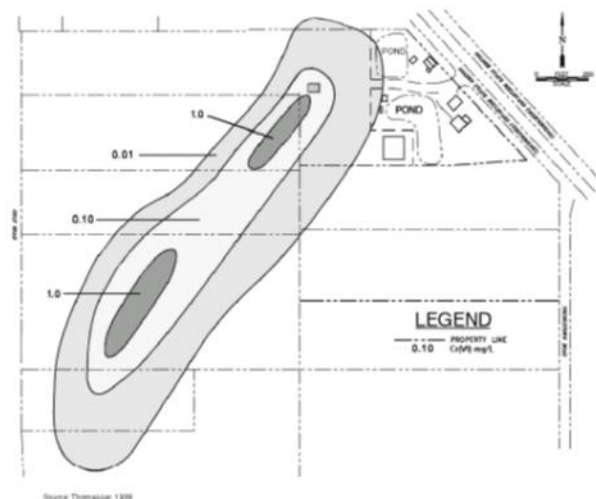

Figure 3-2. Plot of Cr(VI) contaminant plume at the Valley Wood Preserving site - January 1998.

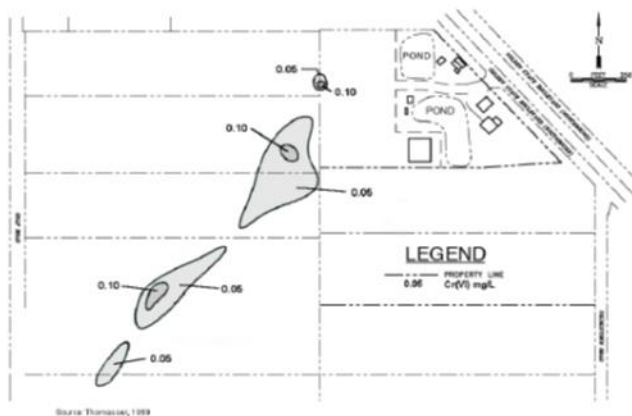

Figure 3-3. Plot of Cr(VI) contaminant plume at the Valley Wood Preserving site - November 1999.

Source: Suthersan, Payne, 2004

Site: Turlock, Ca, USA

Spill: release of about 3,000 kg Cr<sup>+6</sup>, arsenic

7-year pump-and-treat treatment – approx. 50% removal (pumping of 40,000 m<sup>3</sup> of water). Achieving the goal – would require further 10 years of pumping.

Treatment: application of sodium bisulphite (metabisulphite) as an additive to treated water injected back into aquiferous layers.

Time: January 1998-October 1999.  
Effectiveness 98%

Side effect – exceeding the allowable concentration of sulphates and, at some places, manganese.

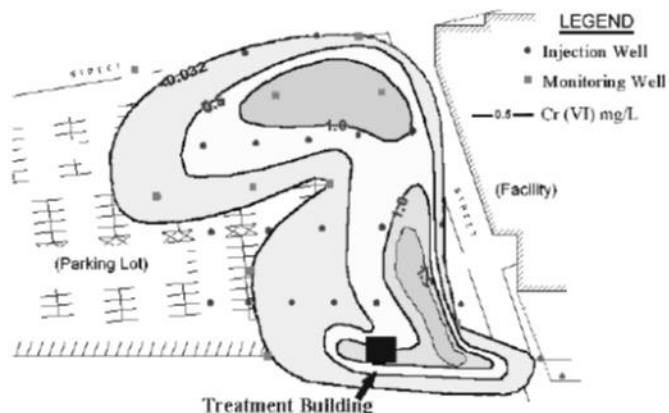

Figure 3-12. Plot of hexavalent chromium contaminant plume at central Pennsylvania site - January 1997.

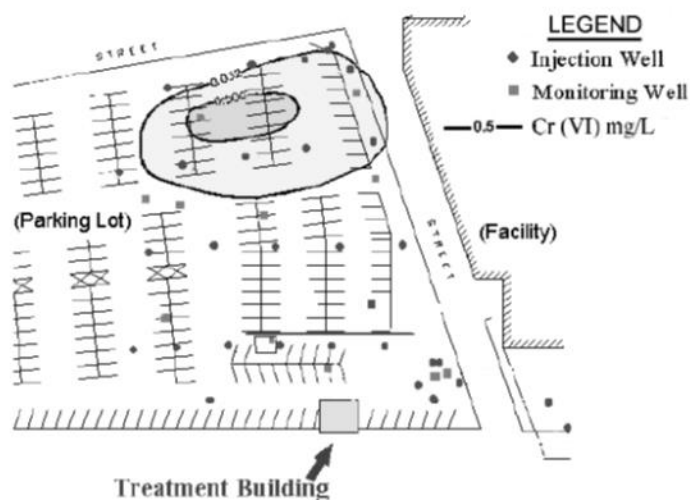

Figure 3-13. Plot of hexavalent chromium contaminant plume at central Pennsylvania site - July 1998.

Site: Avco Lycoming Superfund site in Williamsport, PA, USA

Contaminants: chromium  $\text{Cr}^{+6}$  2.29 mg/l; dissolved cadmium 0.26 mg/l

Treatment: injections of diluted (20–200 times) molasses, 2 times a day, 45 liters per well (36). Duration 46 months: 99% reduction in  $\text{Cr}^{+6}$ , 62% reduction of Cd (solubl)

The cost of 400 thousand \$ (10 times less than pump&treat).

Part 4

**Methods of remediation  
of soil and groundwater:  
Physical methods**



## Removal of soil pollutants by physical methods

### Removal of pollutants without changing chemical structure

- removal of primary sources of pollution
- removal of polluted soil – secondary sources of pollution ("dig and dump", excavation of soil, dredging of bottom sediments)
- LNAPL free phase recovery (skimming)
- vapour extraction
- multiphase extraction
- pumping out and treatment of contaminated groundwater ("pump and treat")
- in- and ex-situ soil washing (extraction)
- in- and ex-situ thermal desorption
- electroremediation

# LNAPL skimming

Light Non-Aqueous Phase Liquids; petroleum products: fuels, oil...

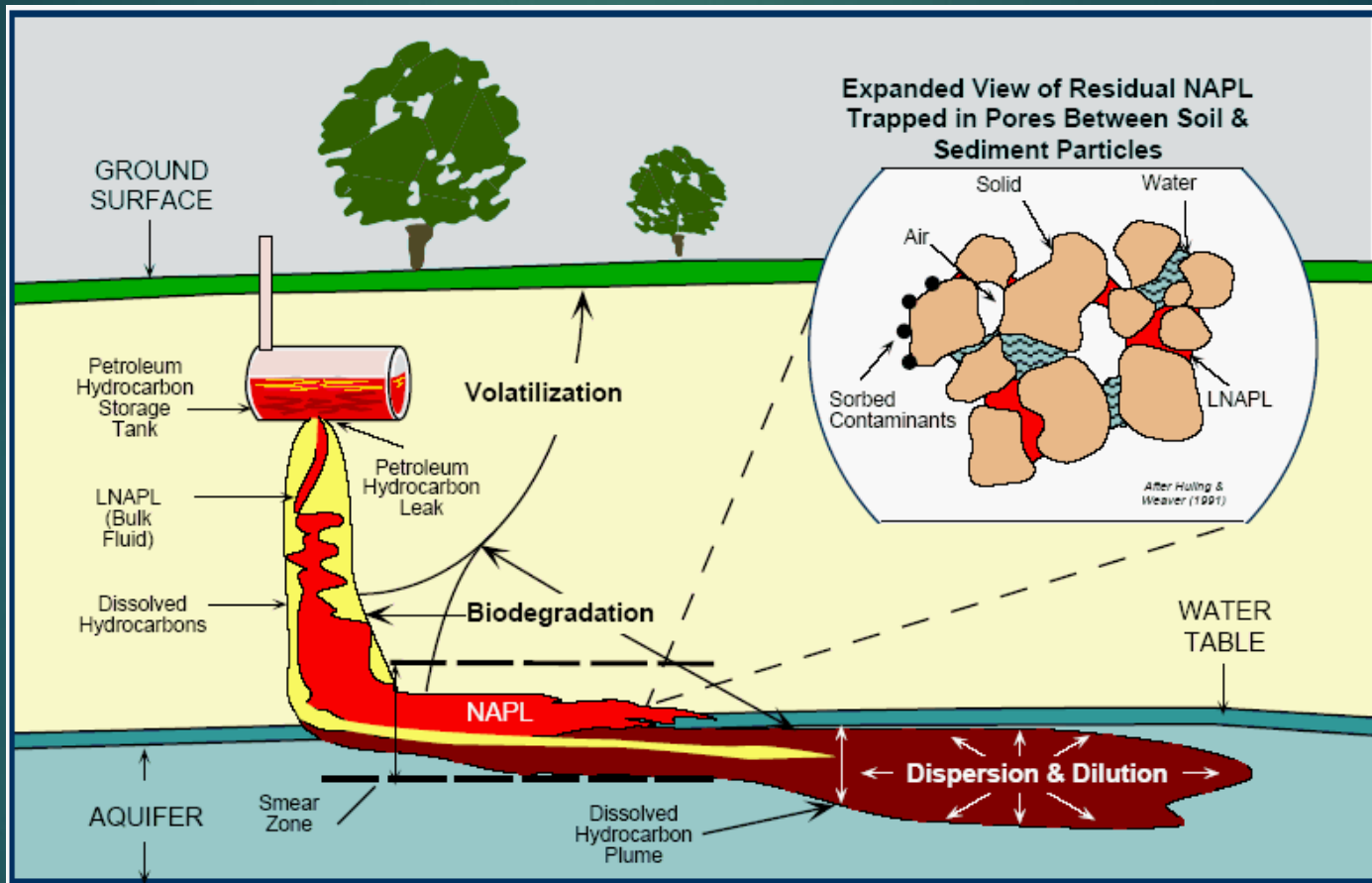

Source: [www.hazmatmag.com](http://www.hazmatmag.com)

Initial stage of LNAPL remediation: removal of free product

## LNAPL free phase recovery

- interceptor trenches, drains
- skimming wells
  - without groundwater pumping (no hydraulic cone)
  - with groundwater pumping (skimming with pump draw-down)
- vacuum-enhanced recovery (dual-phase recovery, multi-phase extraction, bioslurping)



# LNAPL skimming: interceptor trenches, drains

145

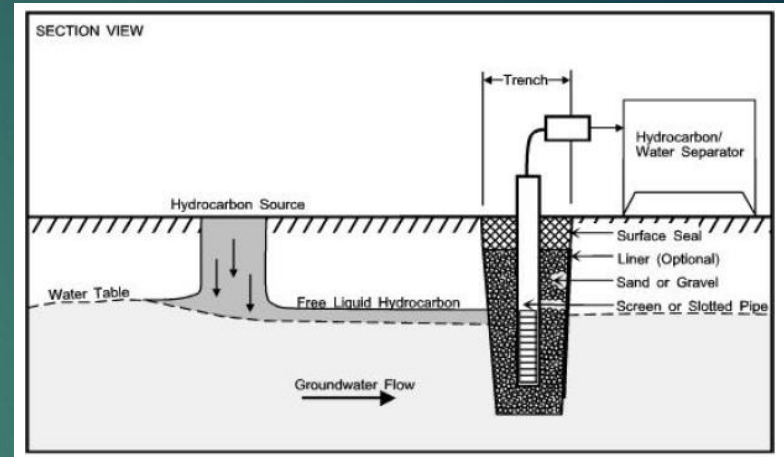
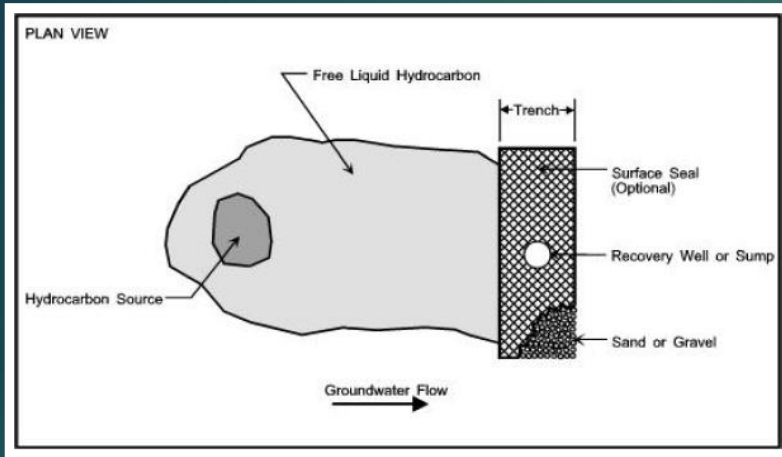

Source: EPA 510-R-96-001

- used at low hydraulic conductivity, heterogenous geology, relatively shallow (<3 m) groundwater table with no fluctuations
- trenches – should be deeper min. 1 m below the water table; perpendicular to groundwater flow
- trenches open or filled with permeable material or with drains; can be lined to create a barrier
- connected to collecting wells in which LNAPL is collected and pumped out (separator and water treatment necessary)



Contamination of Graby-67 waste pit before and after drying



I stage



II stage

Drainage of Graby-67 waste pit (1st year of treatment)

# LNAPL skimming: skimming wells, no pumping

147

Limited LNAPL layer thickness, slow method, low radius impact

- passive skimmers (adsorbing bail or canister – periodically exchanged)
- mechanical skimmers (various types: with pneumatic pump, belt skimmers)

Wells even of 100 (50 for passive) mm diameter minimum

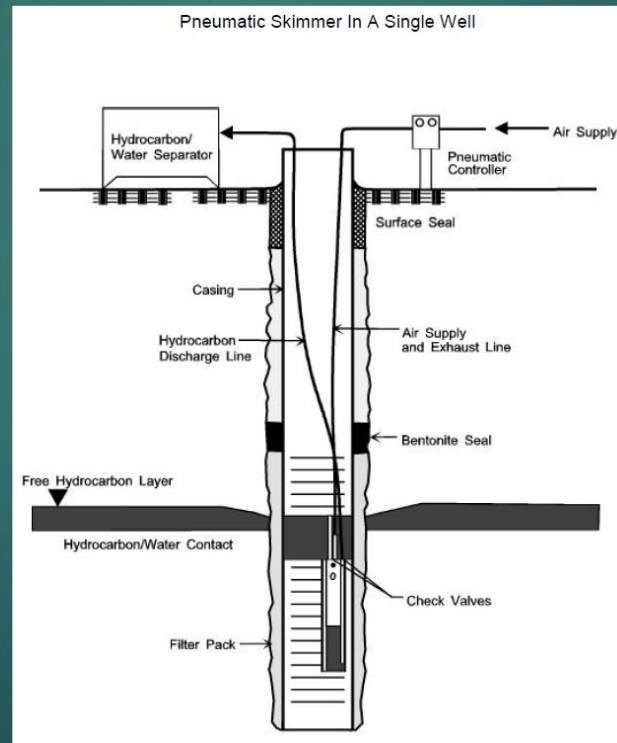

Source: EPA 510-R-96-001

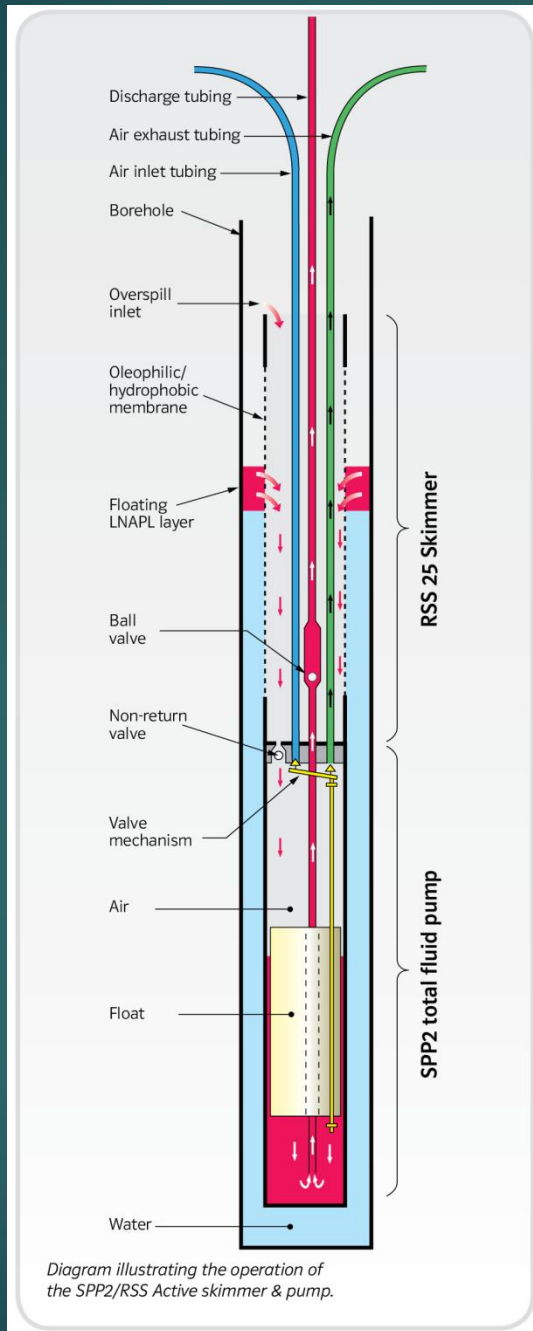

Source: <http://www.waterrauk.com>

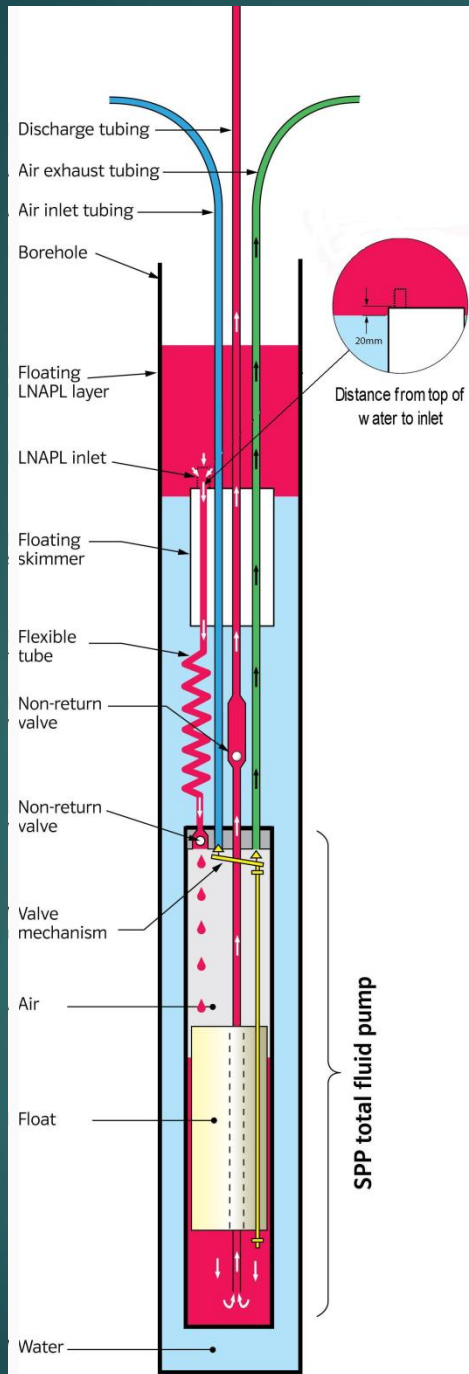

Source: <http://www.waterrauk.com>

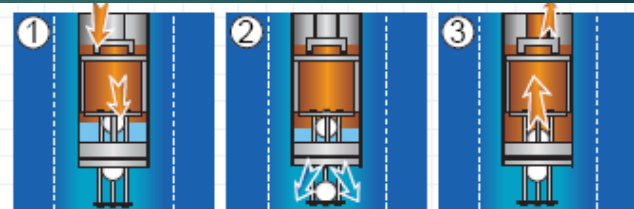
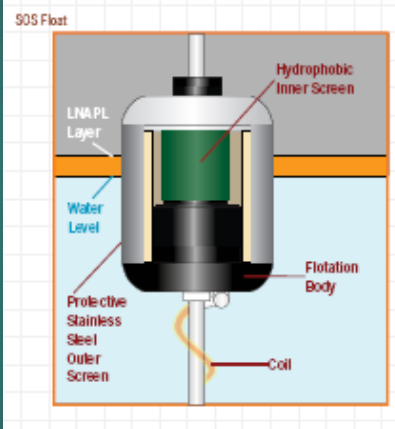
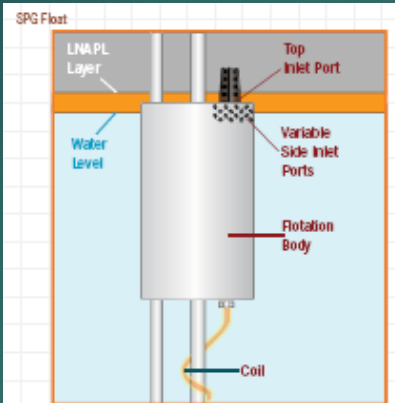
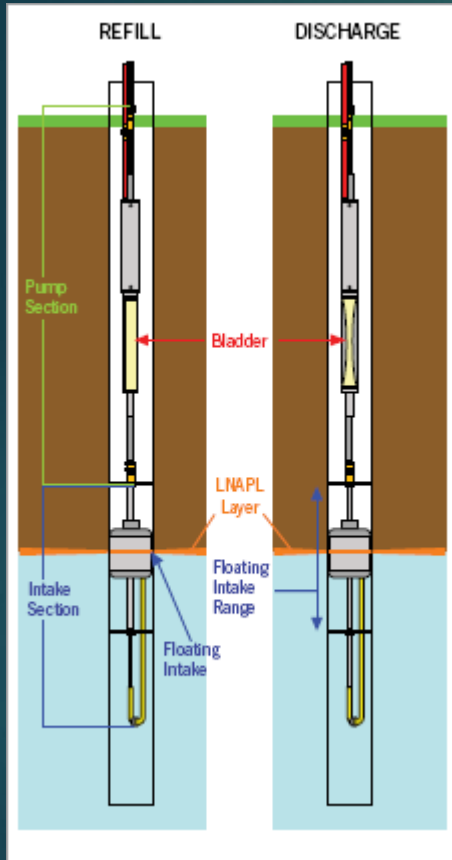

**Refill Cycle:**  
**Air Supply OFF**  
 Hydrocarbon (red) and/or water (blue) enter the inlet. As the pump fills, water settles to the bottom and hydrocarbon droplets coalesce and float on top. The lower check ball floats and rises, preventing water from entering the bottom of the pump.

**Water Discharge Cycle:**  
**Air Supply ON**  
 Air pressure forces the lower check ball down, while the upper check ball floats, allowing water to exit the bottom of the pump. Low pressure in the pump keeps the pressure check valve shut, blocking the discharge line so no water is pumped to the surface.

**Hydrocarbon Discharge Cycle:**  
**Air Supply ON**  
 After the water is gone, the upper check ball sinks in the hydrocarbon and seats, closing off the pump bottom and allowing pump pressure to build. The pressure check valve opens, releasing hydrocarbon into the pump discharge line and tube to the surface.

Source: [www.qedenv.com](http://www.qedenv.com)

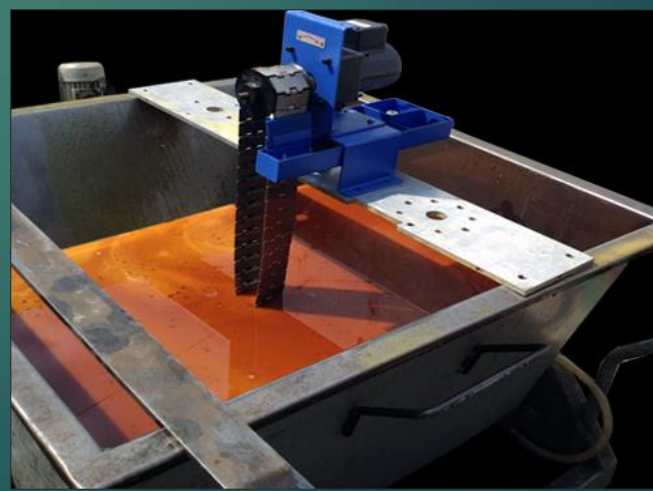

Source: [www.indiamart.com](http://www.indiamart.com)

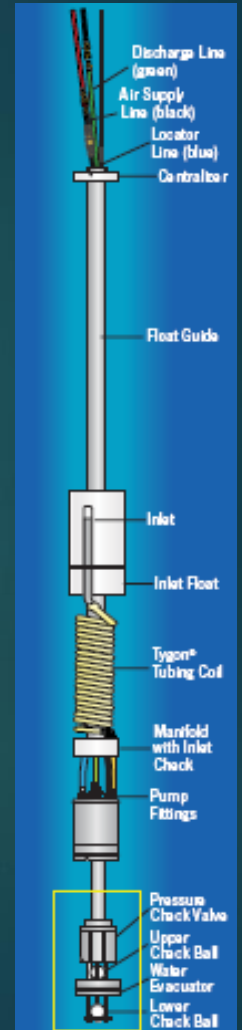

## LNAPL skimming: skimming wells, with pumping

151

- pumping of water together with LNAPL
- much faster (even 10 times) – creating a hydraulic depression, thus migration of LNAPL; greater radius of influence; however, lower effectiveness (“smearing zone” within cone of depression)
- one or dual pumping systems
- treatment of water necessary; possible re-injection of treated water to further manipulate hydraulic gradient; re-injected water may be heated (increasing LNAPL mobility, lowering viscosity, enhancing solubility)

Figure 3. Dual-Pump Recovery Schematic

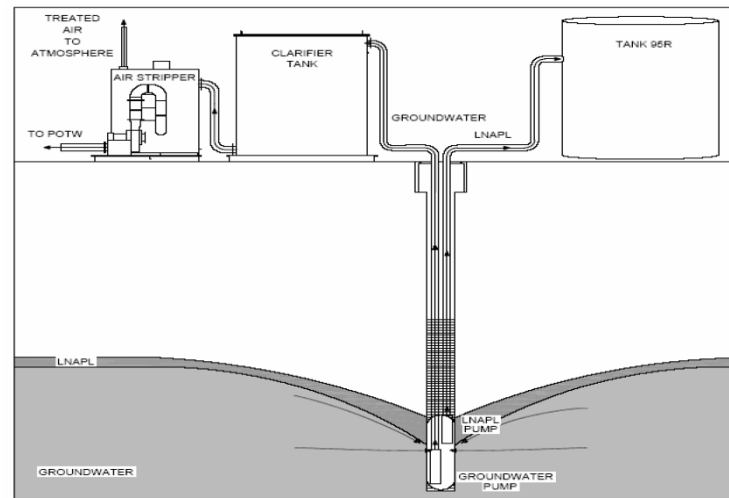

Source: EPA 542-R-05-016

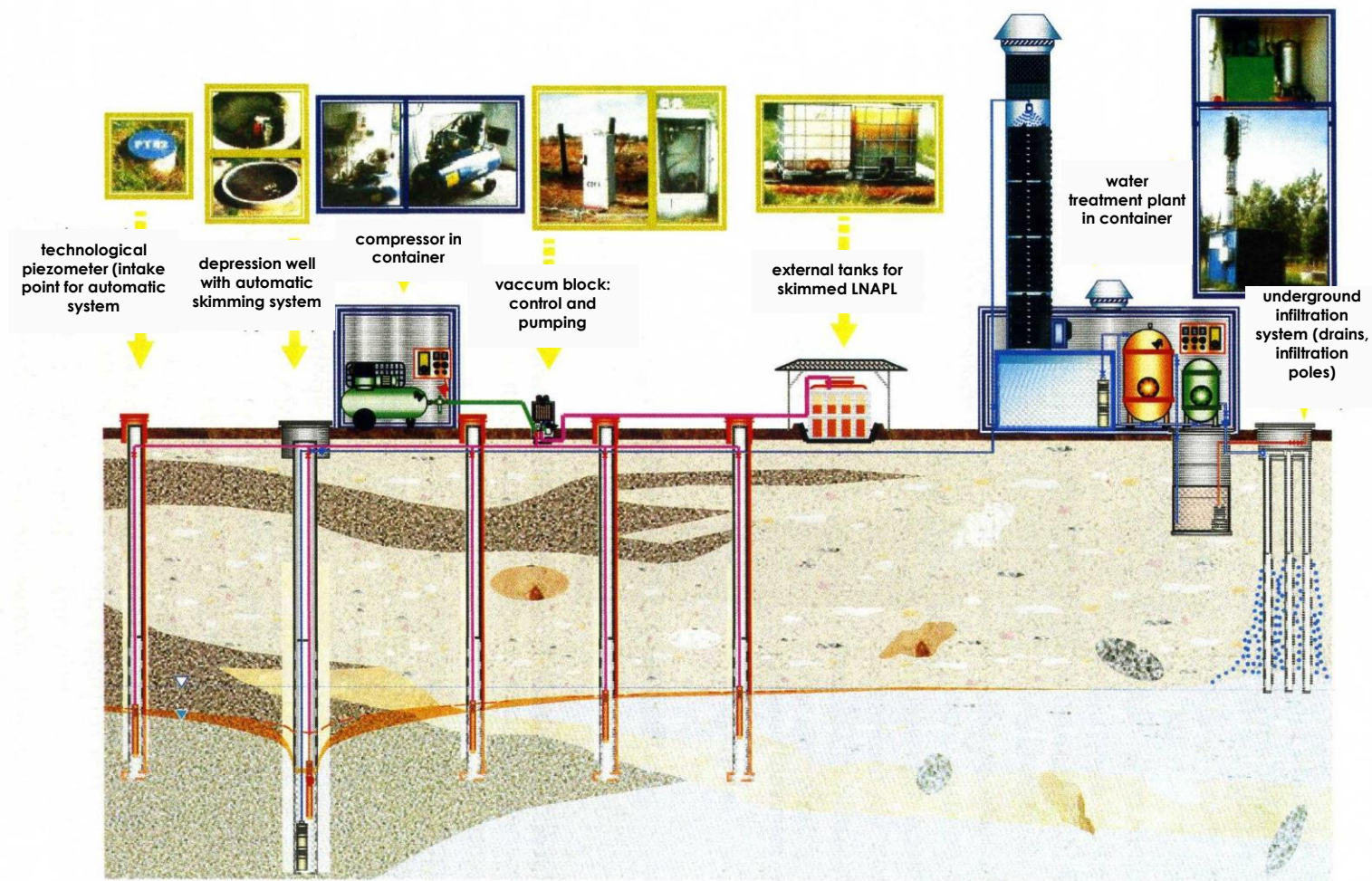

Scheme of skimming-depression-infiltration system (Woźniak 2006)



# Vapour extraction

153

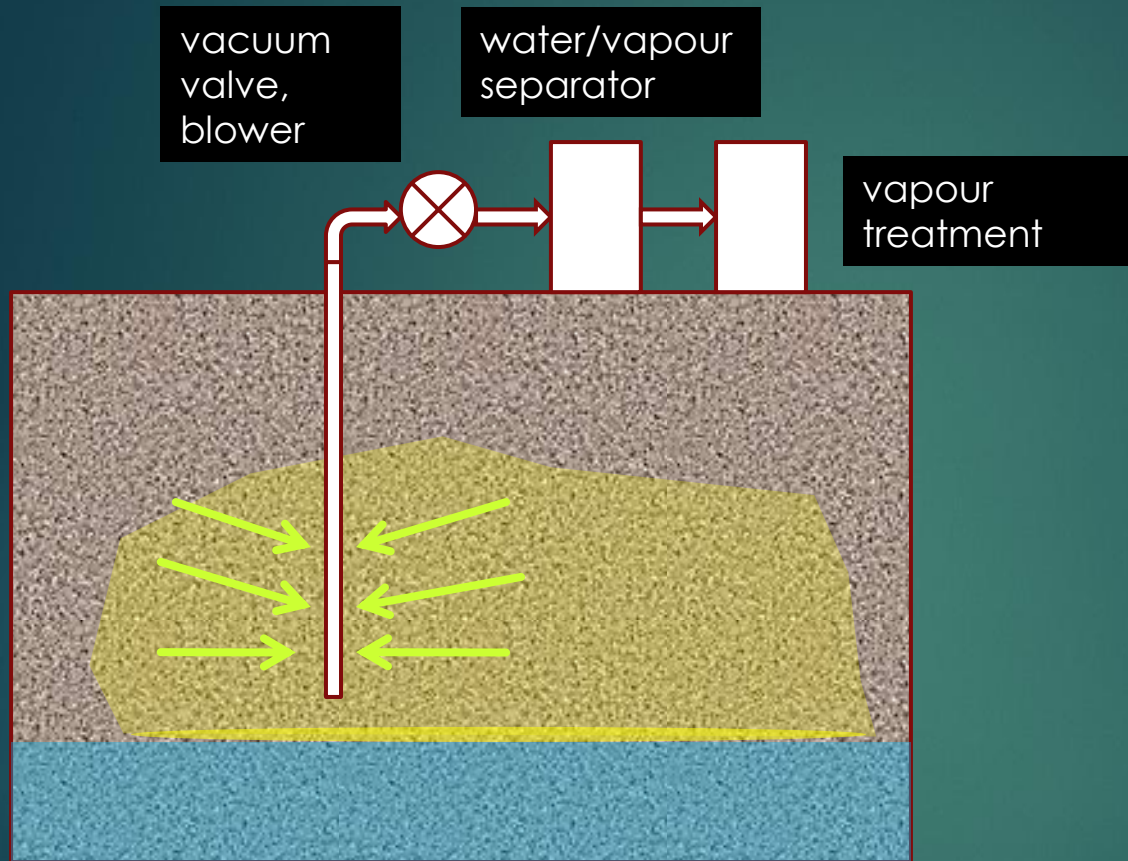

Source: Suthersan, 1997

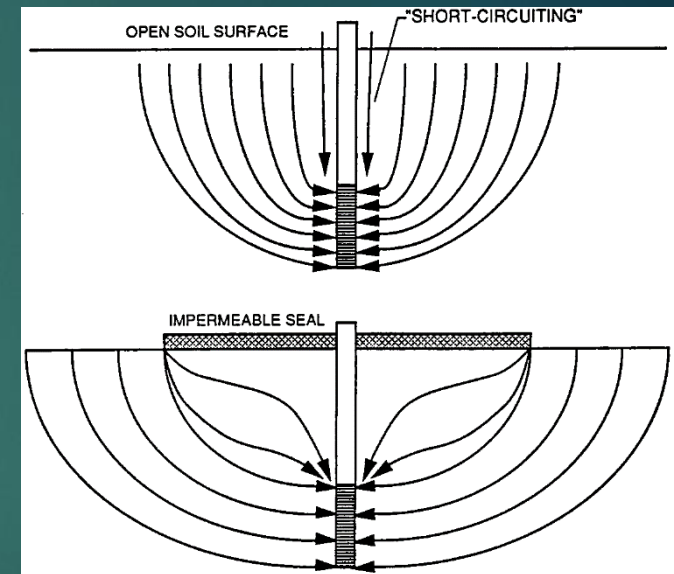

Effectiveness depends on: type of pollution, soil permeability, soil moisture, organic fraction content, etc.

Can be performed together with biological process (bioventing).

Depth from 1.5 to 90 m. Duration – years. Costs: 400–1,500 \$/m<sup>3</sup>

Horizontal wells also possible.

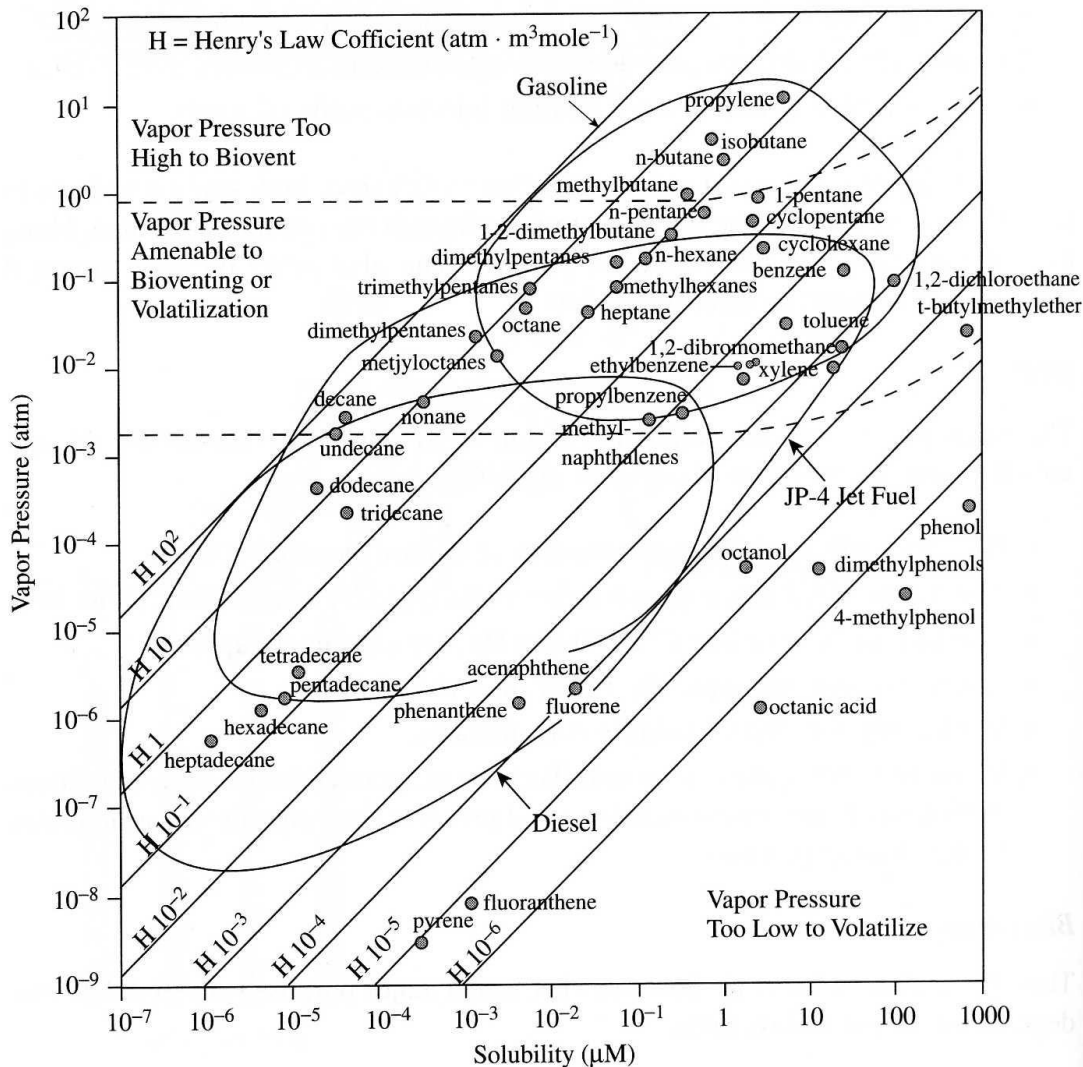

Applicable for pollutants:

- vapour pressure min. 1 mm Hg at 20°C
- Henry's constant greater than 0.01 ( $0.001 \text{ atm m}^3/\text{mol}$ ).

**Figure 8.15.** Effect of contaminant solubility, vapor pressure, and Henry's constant on the potential effectiveness of bioventing. (From Hincbee 1994b.)

# Vapour extraction

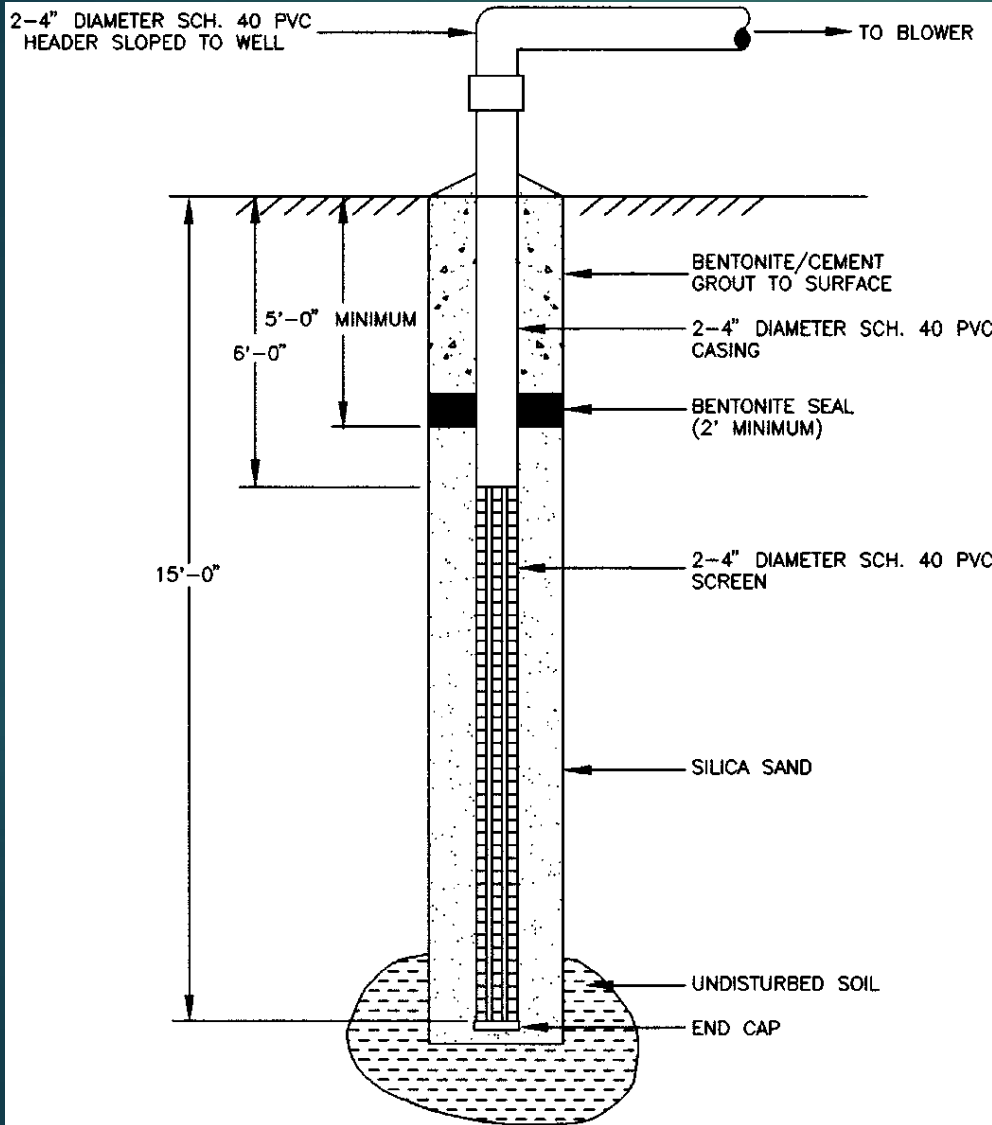

Field tests – determining the radius by assessing the pressure drop.

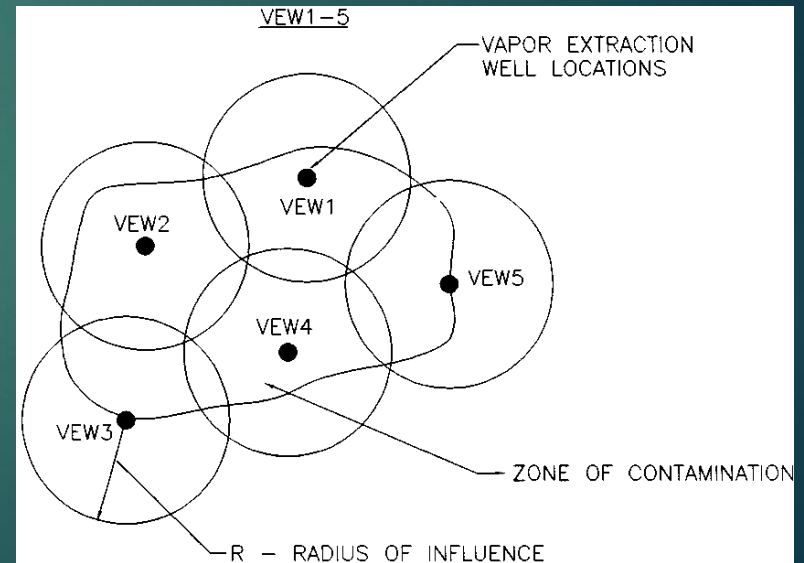

# Vacuum enhanced extraction, dual-phase extraction

156

Simultaneous extraction of LNAPL and vapours, using vacuum pumps. Frequently combined with biodegradation.

More effective with classic skimming, low thickness of LNAPL, lower soil permeability; further stage of treatment.

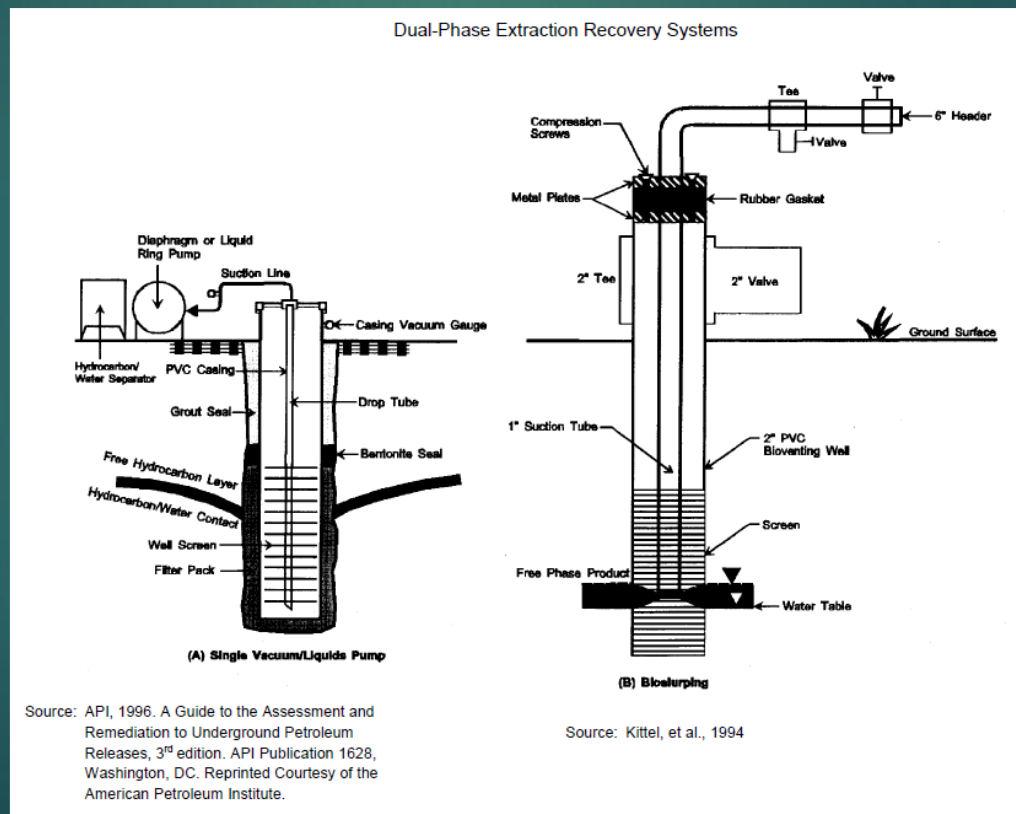

## Vapor Extraction/Groundwater Extraction (VE/GE) Recovery System

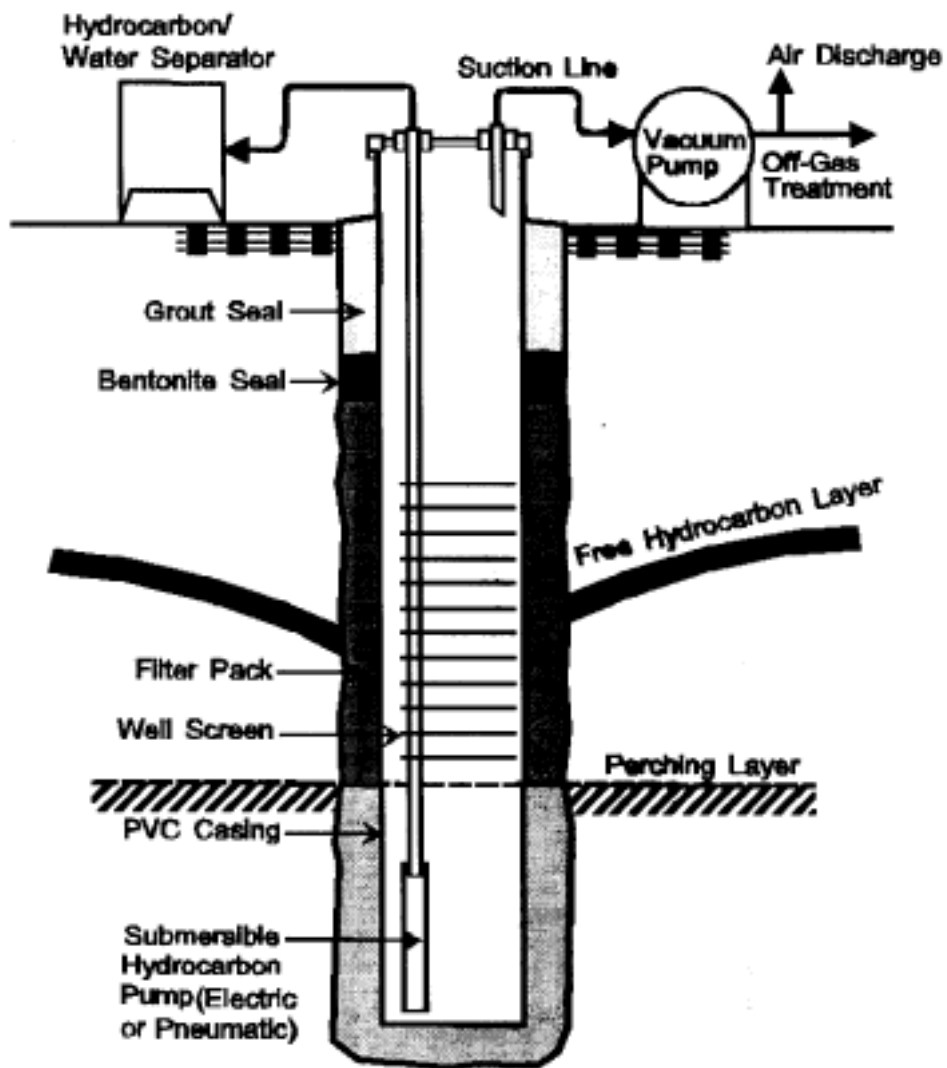

Separate Vacuum and Liquids Pump (VE/GE)

# Multi-phase extraction

Simultaneous extraction of water, LNAPL and vapours, plus stimulation of biodegradation (bioventing)

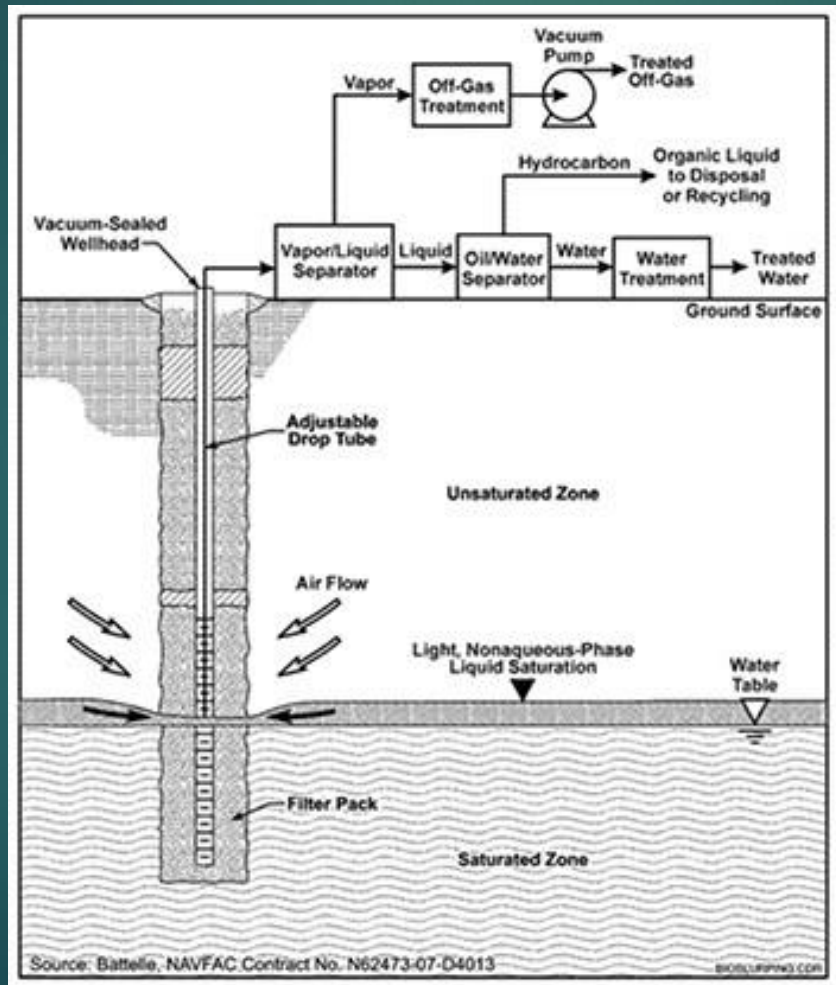

## LNAPL and vapour (VOC-volatile organic compounds) recovery

### Methods of process intensification:

- pressure pulsation: high amplitude, approx. 15 pulses per min. LNAPL displacement occurs, pores are opened, flow increases (up to 7.5 times compared to conventional extractions)
- thermal enhancement: reduced viscosity and mobility of LNAPL, flotation due to floating air bubbles, increased evaporation. Particularly recommended for poorly permeable soils (clays). Injection of hot air, steam; resistive heating (current – additionally drying and cracking of the soil), heating with radio waves
- hydraulic and pneumatic fracturing

## Pumping out polluted groundwater – “pump and treat”

160

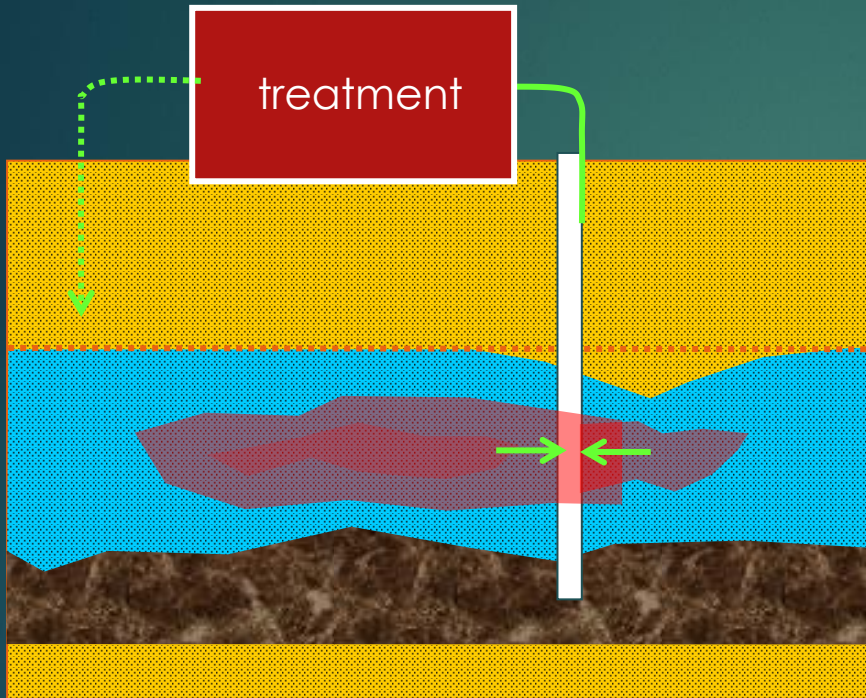

- pumping out polluted groundwater
- treatment
- discharge – to surface waters or back to the ground

It can be used for:

- 1) hydraulic containment – in connexion with hydraulic barriers
- 2) remediation, removal of pollutants

Wells, horizontal well, trenches.

Combined with other remediation methods.

The method is suitable for the following cases:

- contaminants well soluble in water
- soils of good permeability; homogenous
- situations indicating the possibility of reaching the goal in a short time (however, it may require years)



# Pumping out polluted groundwater – “pump and treat”

161

Options for treatment:

- **Biological. Applicable if concentrations are low enough and the biological processes are not inhibited:**
  - activated sludge systems
  - sequencing batch reactor
  - powdered activated carbon in activated sludge
  - rotating biological contactors
  - aerobic fluidized bed biological reactor
- **Physical/Chemical:**
  - air stripping
  - activated carbon
  - ion exchange
  - reverse osmosis
  - chemical precipitation of metals
  - chemical oxidation
  - chemically assisted clarification
  - filtration
  - ultraviolet (UV) radiation oxidation

# Pumping out polluted groundwater – “pump and treat”

**Tailing:** progressively slower rate of decline in dissolved contaminant concentration with continued operation of a pump-and-treat system.

**Rebound:** rapid increase in contaminant concentration that can occur after pumping has been discontinued.

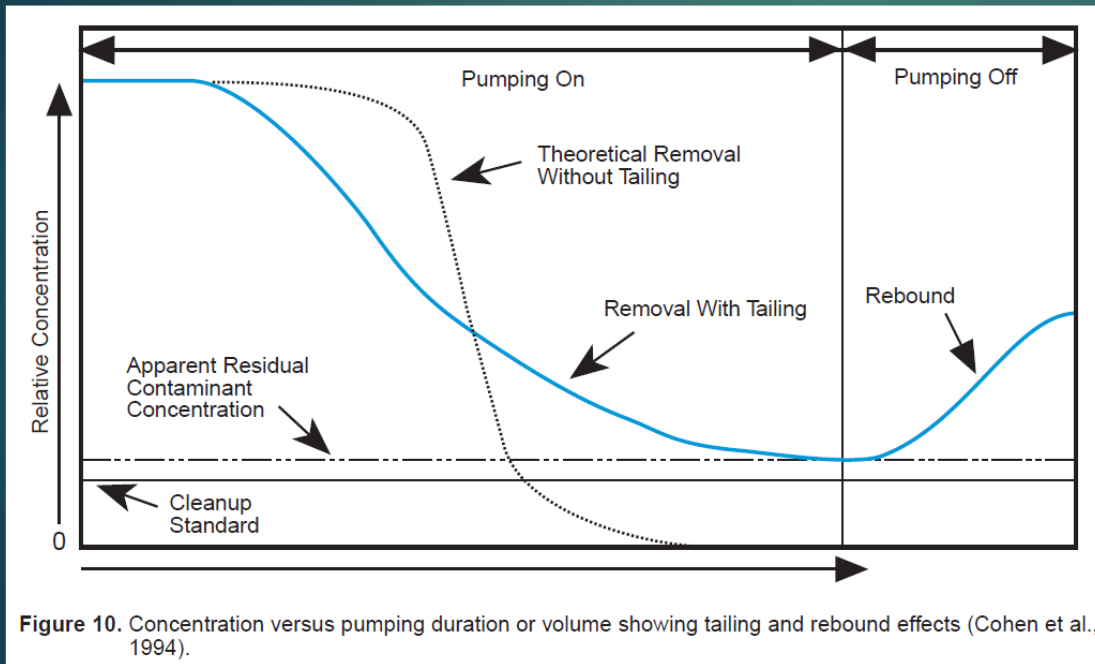
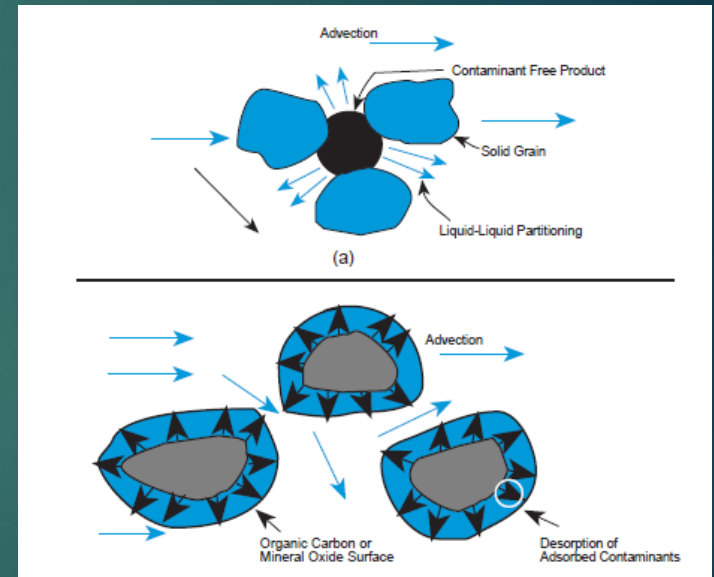

Figure 10. Concentration versus pumping duration or volume showing tailing and rebound effects (Cohen et al., 1994).



Source: [www.oaspub.epa.gov](http://www.oaspub.epa.gov)

Longer treatment time – multiplication of the volume of pumped water; difficulty in achieving treatment goal.

# Pumping out polluted groundwater – “pump and treat”

163

## Contributing factors:

- LNAPL presence
- desorption of contaminants
- dissolution of precipitates
- matrix diffusion
- groundwater velocity variations
- presence of stagnation zones

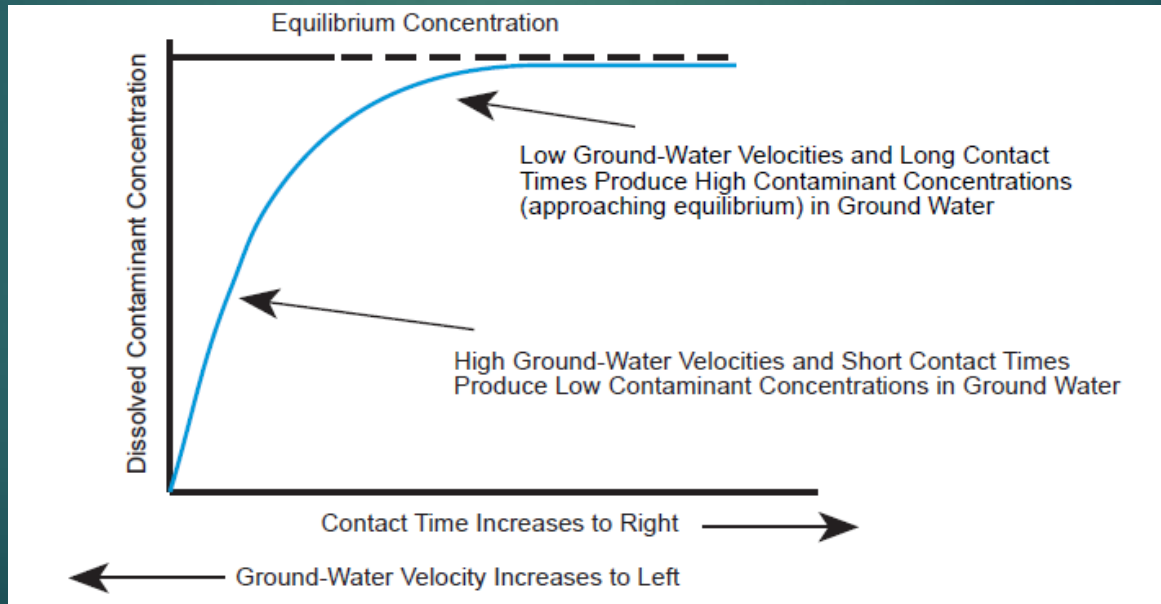

# Pumping out polluted groundwater – “pump and treat”

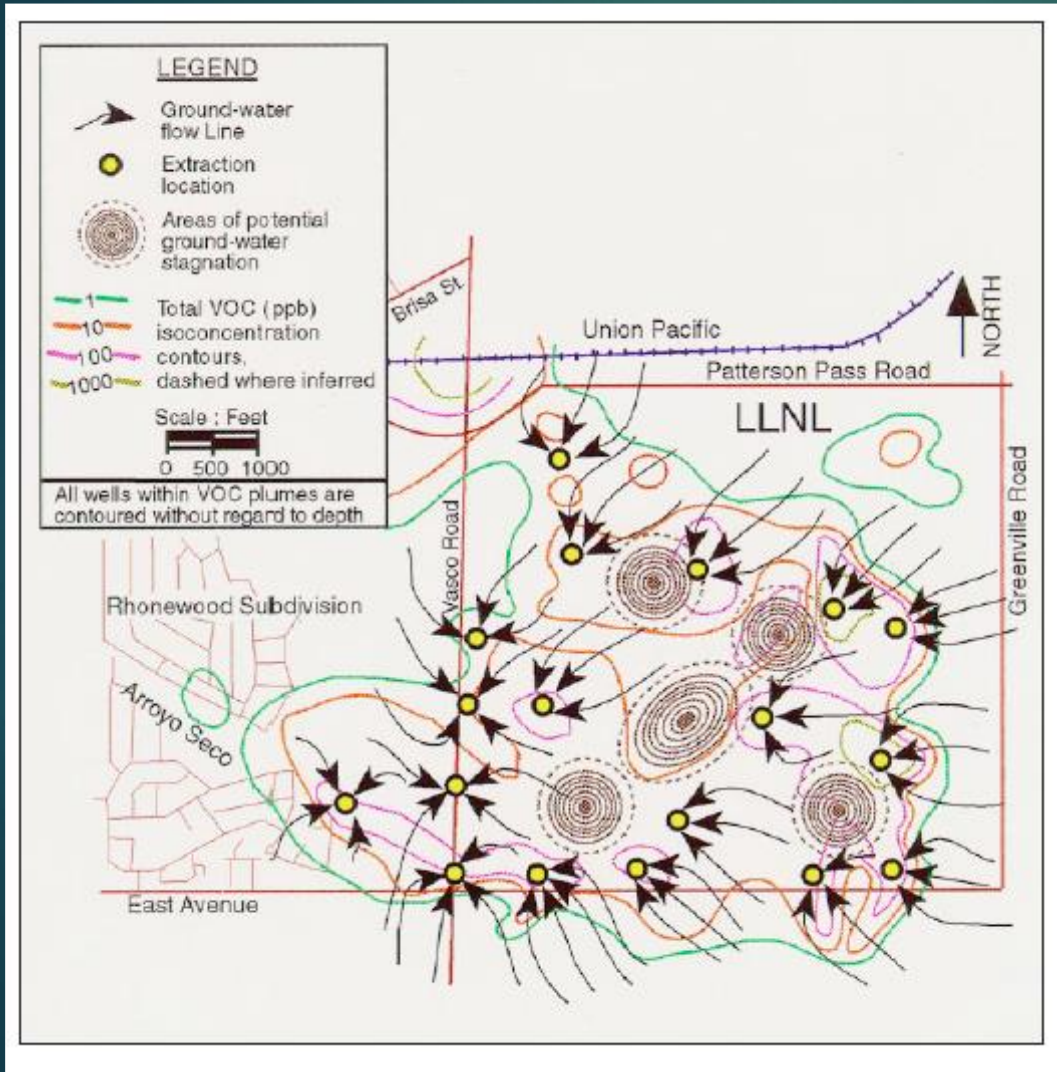

Source: [www.oaspub.epa.gov](http://www.oaspub.epa.gov)

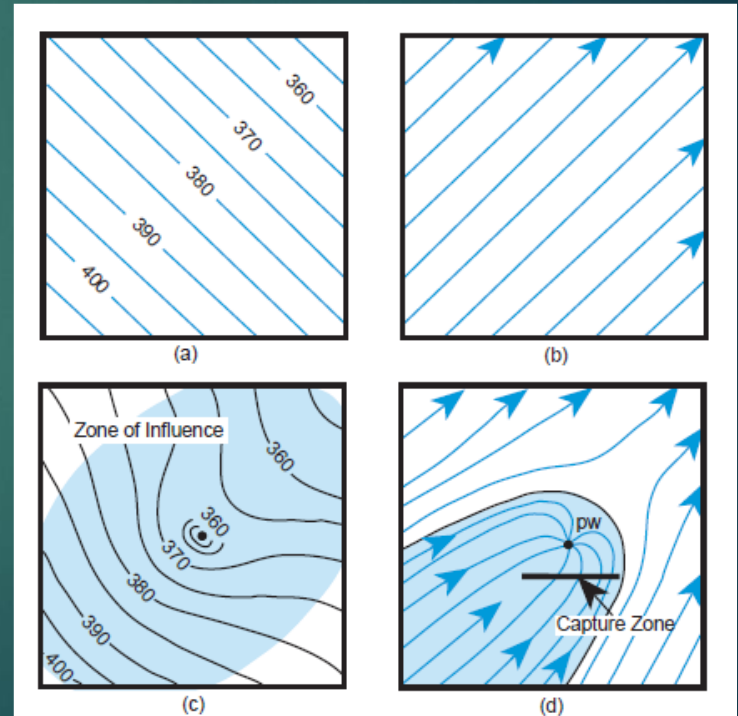

## Pumping out polluted groundwater – “pump and treat”

### Causes of failures:

- presence of zones with low hydraulic conductivity
- low desorption rate of contaminants
- no removal of pollution sources, e.g. non-water-immersible liquids (NAPL).

Time needed for remediation – a number of years or even decades.

## Pumping out polluted groundwater – “pump and treat”

### The pulsed pumping concept

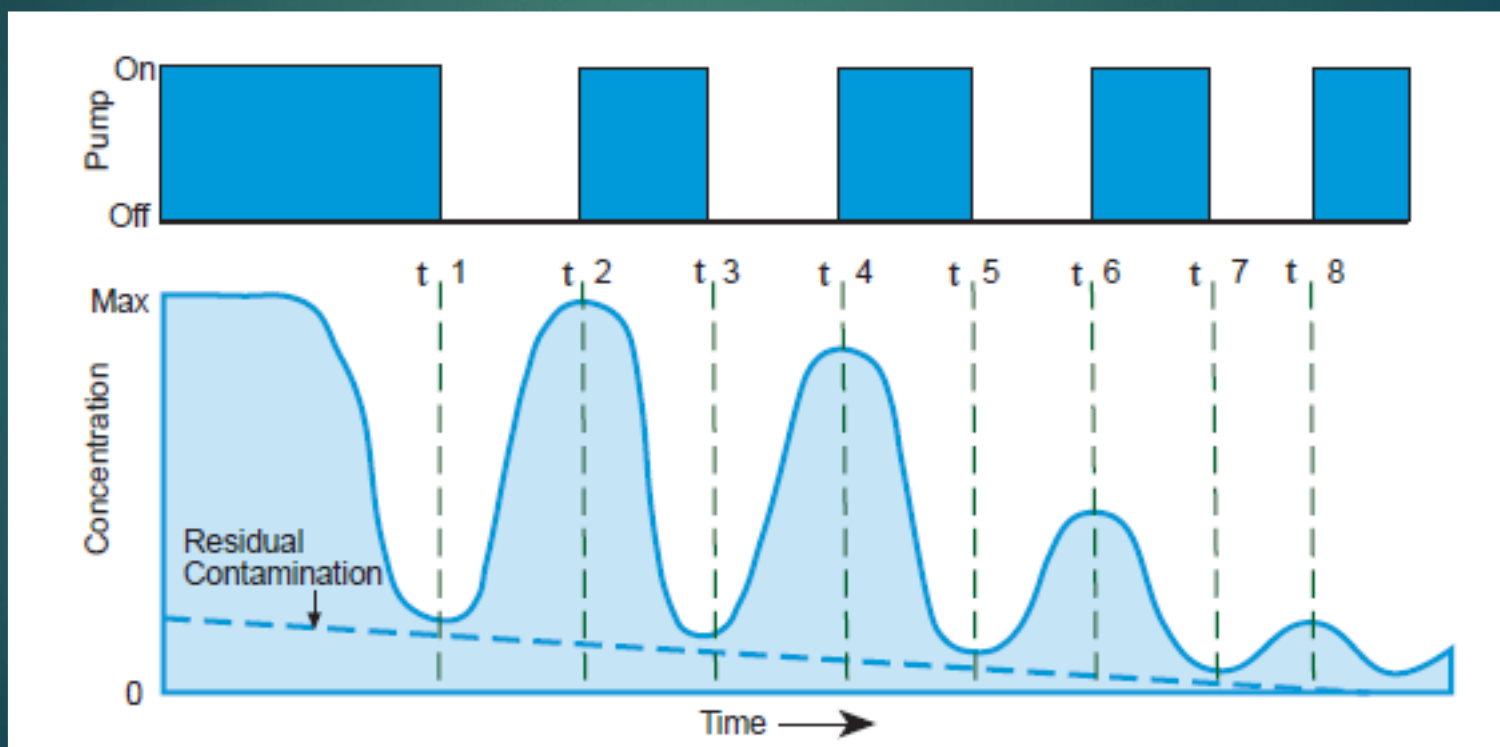

Leaching of pollutants from soil using liquids selected for contaminants

in-situ method: soil flushing

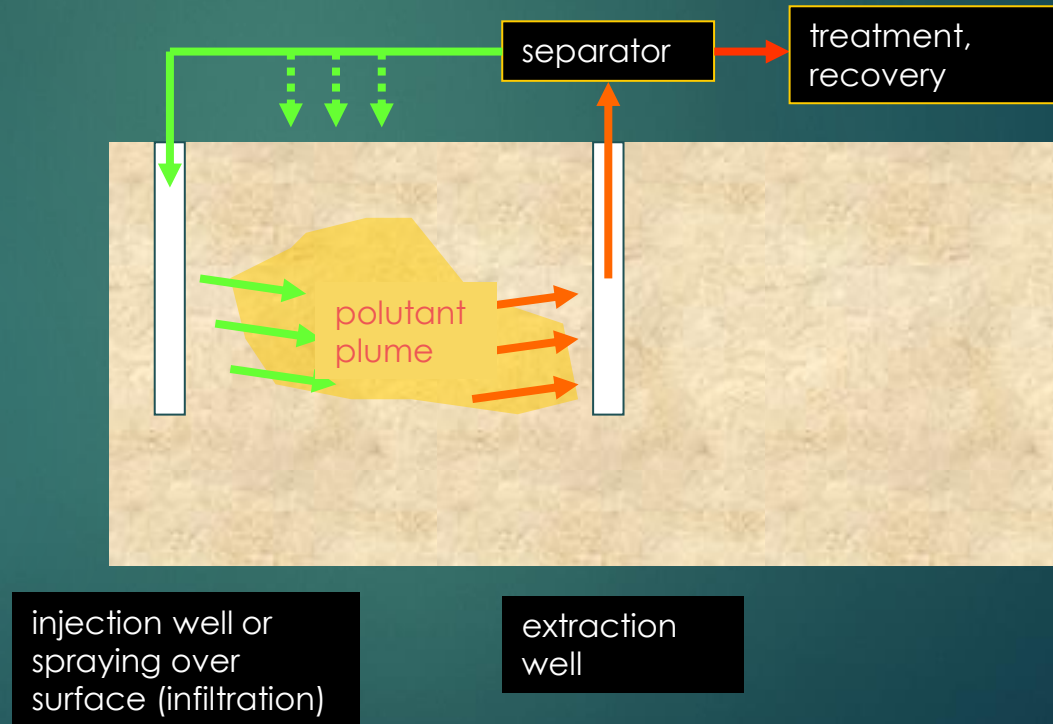

## Extraction of pollutants

ex-situ method: soil washing/rinsing

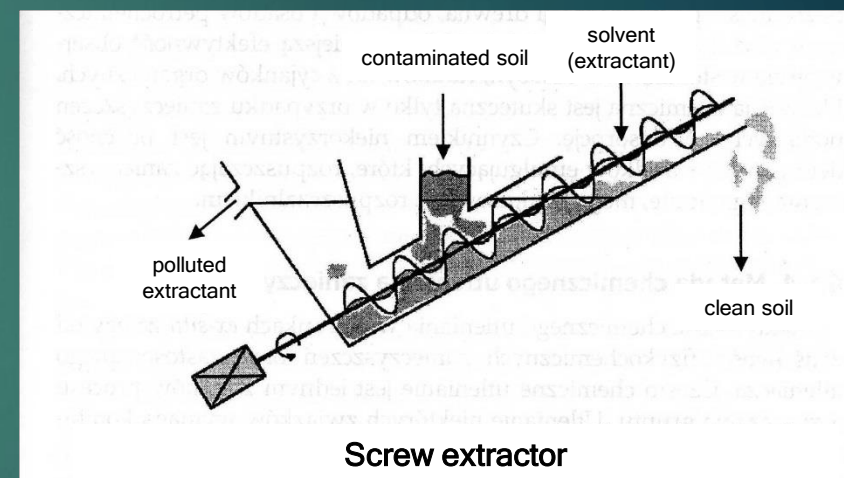
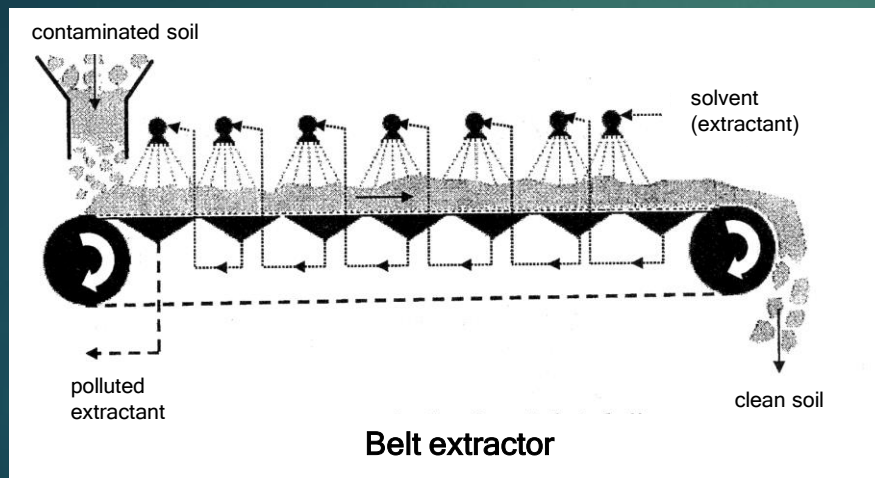

Source: Malina, 2007

Soil washing: physical separation of contaminated fine fractions of soil: clay, silt particles, from coarse fractions: sand, gravel.



## Extraction of pollutants

Type of pollution	Extracting solutions
Heavy metals	synthetic aminopolycarboxylic acids, e.g. EDTA natural biodegradable acids low-molecular organic acids, e.g. citric, oxalic humic substances, e.g. humic and fulvic acids
Organic pollutants	organic solvents, e.g. acetone surfactants solutions cyclodextrins solutions

## Thermal desorption

Soil heating to evaporate water and volatilize organic pollutants. The vapours are transported to the treatment system. Applicability: PAHs, PCBs, pesticides, petroleum products, some metals.

- Non-destructive systems – only volatilization of pollutants.
- Destructive – temperature causes oxidation, pyrolysis and others destructive processes:
  - High temperature systems: 320–560°C. Frequently combined with incineration, etc.
  - Low temperature systems: 90–320°C (e.g. oil-derived pollutants).

Note: dioxins can be formed at temperatures above 350°C and with longer retention times. Their removal requires temperatures of 480–560°C.

# Thermal desorption: in-situ systems

171

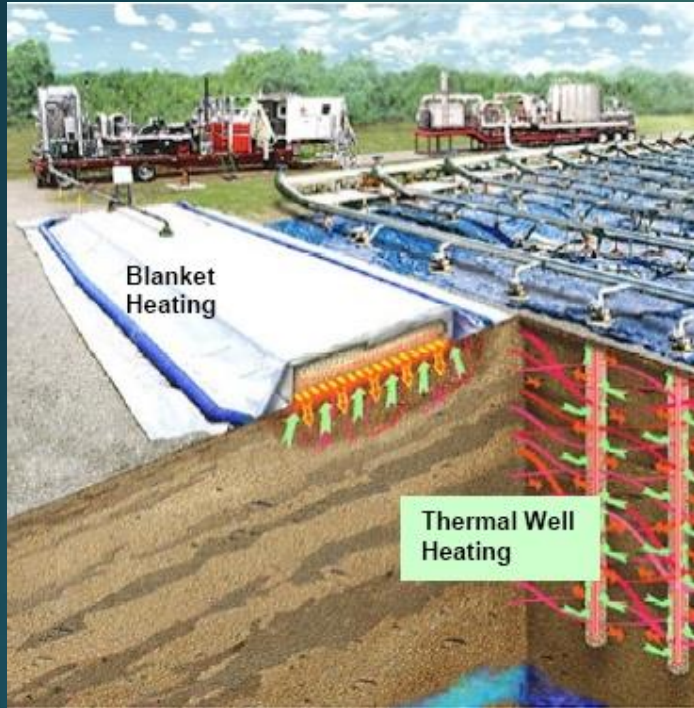

Source: <http://www.terratherm.com>

Heating of polluted soil, removal and treatment of vapours.

Temperatures: on average up to 500°C. Two systems used: vertical wells or horizontal coats (shallow pollution). Thermal conductivity, steam injection or electrothermal method. Volatilization and pyrolysis.

Extraction of vapours: network of extraction wells.

Vapours treatment: thermal oxidation or condensation of vapours with the following adsorption on active carbon.

Application: PCBs, PAHs, dioxins, etc.

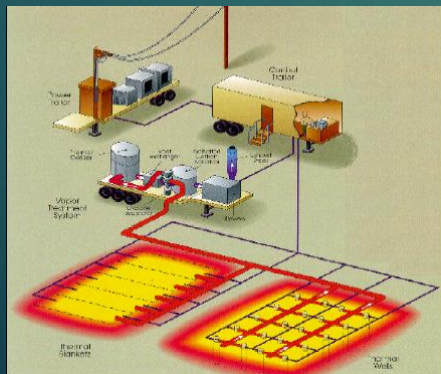

# Thermal desorption: ex-situ systems

172

## Systems:

- direct heating: the flame applied directly to the surface of the contaminated soil
- intermediate flame heating: kilns, hot air
- indirect heating: externally heated rotary kilns, helical furnaces, use of infrared radiation, microwave, etc.

Retention time up to tens of minutes, efficiency up to tens of t/h.

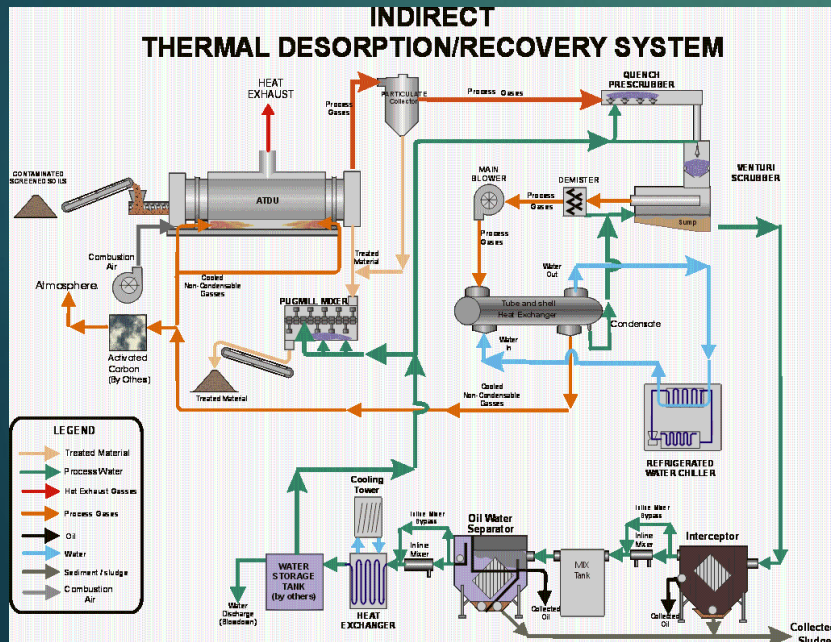

Source: <http://www.rlctechnologies.com>

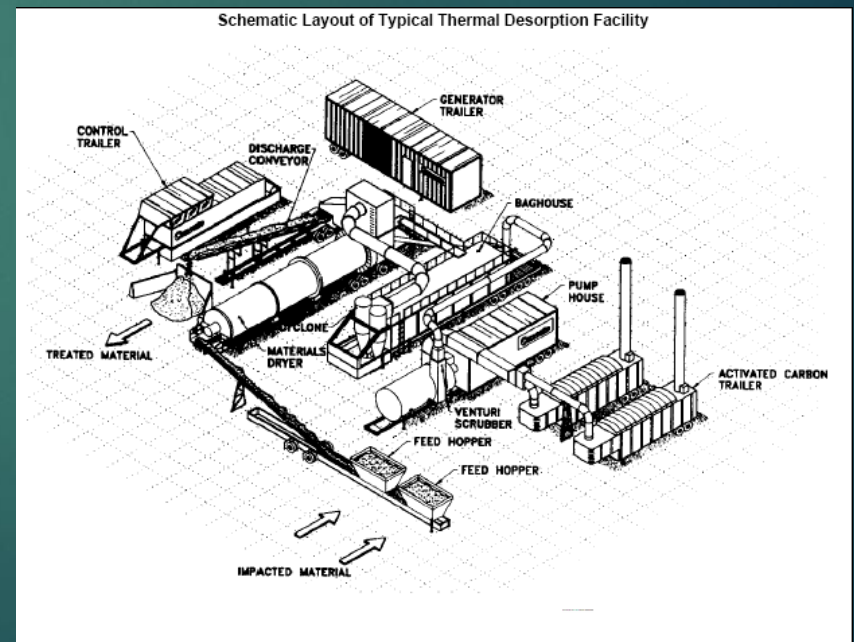

Source: <http://www.clu-in.org>

# Thermal desorption: ex-situ, on-site systems



Source: <http://www.tdxassociates.com>



Source: [www.drtservices.com](http://www.drtservices.com)

# Electroreclamation

174

Applying electric current for desorption and induction of transport of inorganic impurities: heavy metals, cyanides.

Electrodes surrounded by electrolyte absorbing pollutants, periodically replaced/regenerated.

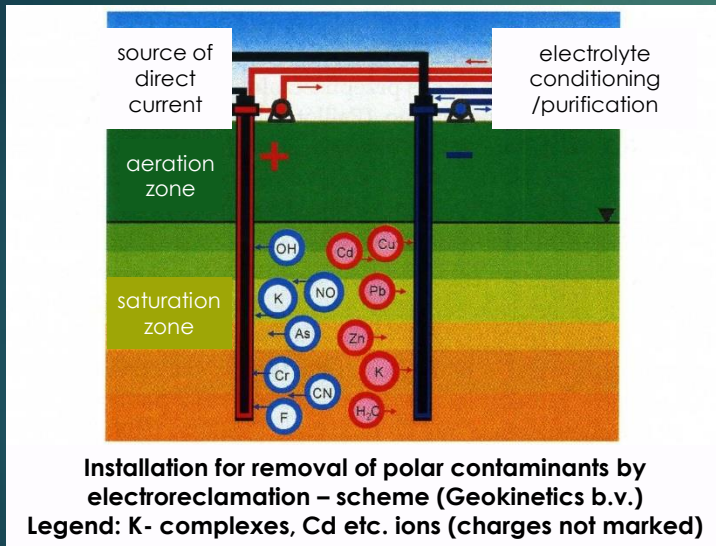

Source: Malina, 2007

It is possible to achieve high rate of removal of contaminants, but the remediation time may be long, removal may require more than 25 volumes of pore water.

Energy demand ~ 1,000 kWh/kg of land, significant cost.

Significant impact of soil pH changes and mobilization of all ions.

The use of electricity to heat the ground and groundwater:

- desorption and volatilization of pollutants (vapour extraction)
- intensification of biological degradation (+injection of nutrients, etc.)

Applicability: volatile organic compounds, light PAHs, BTEX, petroleum derivatives, etc.

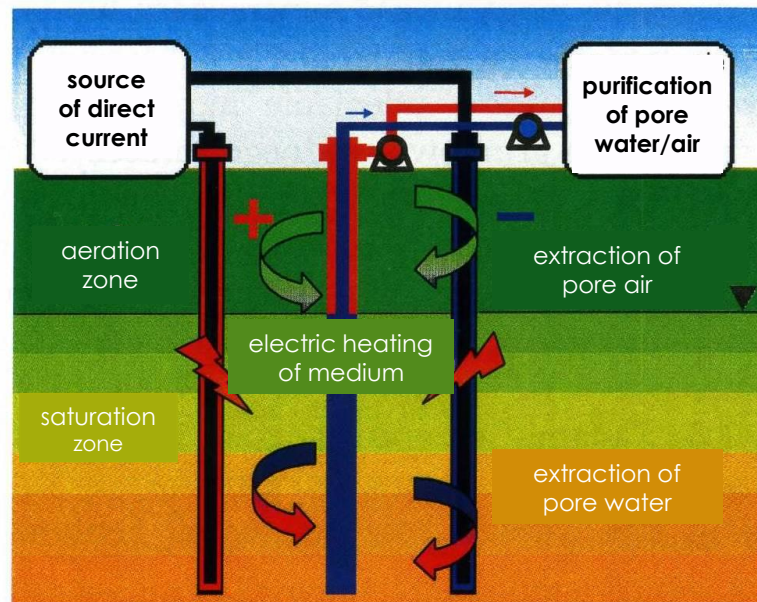

Scheme of electro-bioreclamation (Geokinetics b.v.)

Part 5

# Methods of remediation of soil and groundwater: Chemical methods





## Remediation by chemical methods

Using reagents transforming pollutants:

- mineralization – transformation into simple products, like water, carbon dioxide, chlorides, methane, etc.
- partial transformation – transformation into intermediates (simpler chemicals). Ideally, this should involve detoxification – products should be less toxic/mobile/bioavailable/more susceptible to biodegradation than parent pollutants.

Caution required – undesirable, more harmful products may be formed!

Most often in-situ application (in-situ reactive zones). Combined with other methods (bioremediation, MNA etc.).

## Remediation by chemical methods

### Oxidation/reduction reactions – electron transfer

**Oxidation** – removal of electrons from the compound by oxidant (electron acceptor): addition of oxygen, removal of hydrogen from chemical particle, transformation into simpler products, often mineralization.

Applicable for compounds such as PAHs, chlorinated ethers like trichlorethylene (TCE) or dichloroethylene (DCE), petroleum-based pollutants, including BTEX.

**Reduction** – addition of electrons to the compound particle from reductant (electron donor): removal of oxygen or other oxidant, e.g. chlorine, addition of hydrogen to its structure; usually only partial transformation.

Applicable for organic chlorinated compounds, e.g. tetrachlorethylene, certain pesticides; nitrates.

# Remediation by chemical methods

Most often applied technologies of reagent delivery (essential)

typical radius of influence: less than 4.5–6 m

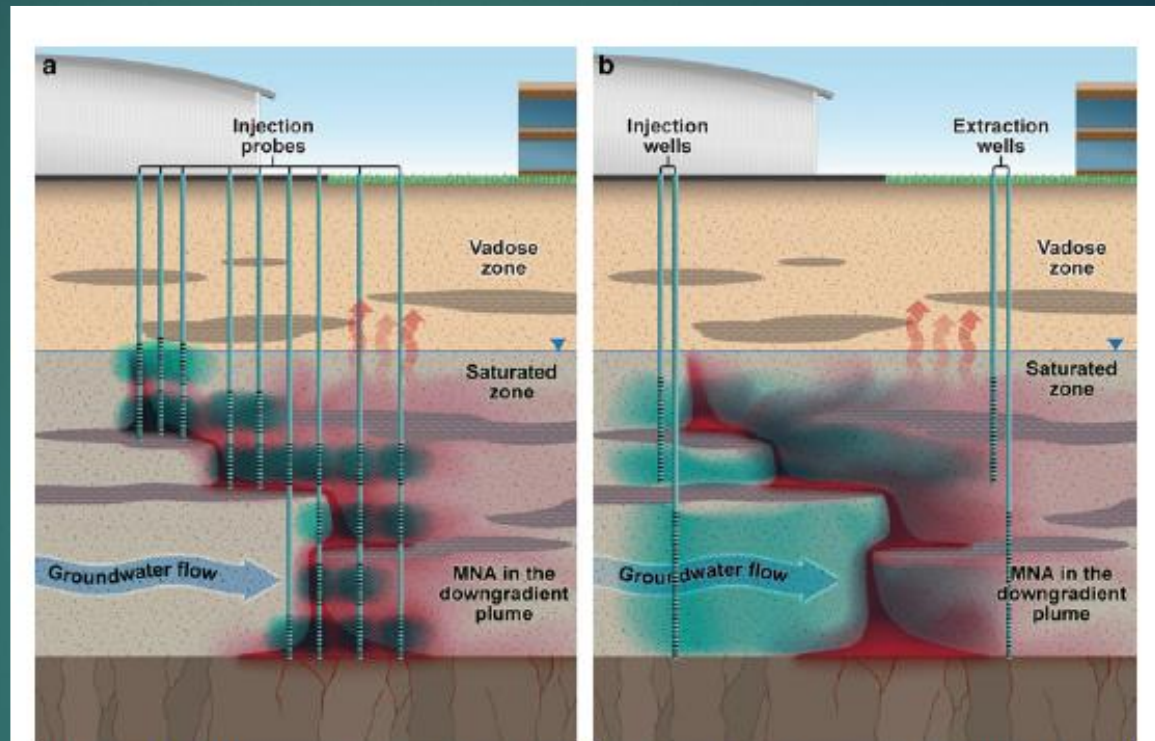

Figure 1.4. *In situ* chemical oxidation using (a) direct-push injection probes or (b) well-to-well flushing to deliver oxidants (shown in blue) into a target treatment zone of groundwater contaminated by DNAPL compounds (shown in red).

Source: Siegrist, Crimi, Simpkin, 2011

horizontal wells, infiltration galleries, hydraulic or pneumatic fracturing; soil mixing (surface)

# Remediation by chemical methods: oxidation

180

Oxidants:

- hydrogen peroxide ( $\text{H}_2\text{O}_2$ ) or other peroxides
- permanganate ( $\text{MnO}_4^-$ )
- ozone ( $\text{O}_3$ )
- persulphate ( $\text{S}_2\text{O}_8^{2-}$ )

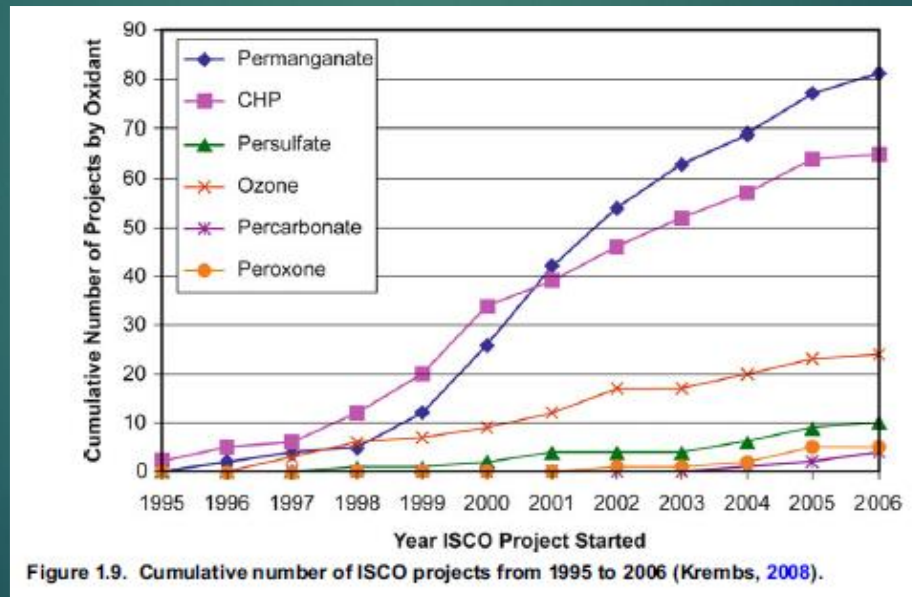

**Table 1.4. Characteristics of Chemical Oxidants Used for Destruction of Organic Contaminants (adapted from Huling and Pivetz, 2006)**

Oxidant <sup>a</sup>	Oxidant chemical	Commercial form	Activator	Reactive species
Permanganate*	KMnO <sub>4</sub> or NaMnO <sub>4</sub>	Powder, liquid	None	MnO <sub>4</sub> <sup>-</sup>
Hydrogen peroxide*	H <sub>2</sub> O <sub>2</sub>	Liquid	None, Fe(II), Fe(III)	OH <sup>*</sup> , O <sub>2</sub> <sup>*-</sup> , HO <sub>2</sub> <sup>*</sup> , HO <sub>2</sub> <sup>-</sup>
Ozone*	O <sub>3</sub> (in air)	Gas	None	O <sub>3</sub> , OH <sup>*</sup>
Persulfate*	Na <sub>2</sub> S <sub>2</sub> O <sub>8</sub>	Powder	None, Fe(II), Fe(III), heat, H <sub>2</sub> O <sub>2</sub> , high pH	S <sub>2</sub> O <sub>8</sub> <sup>2-</sup> , SO <sub>4</sub> <sup>*-</sup>
Peroxone	H <sub>2</sub> O <sub>2</sub> plus O <sub>3</sub> (in air)	Liquid, gas	O <sub>3</sub>	O <sub>3</sub> , OH <sup>*</sup>
Percarbonate	Na <sub>2</sub> CO <sub>3</sub> ·1.5H <sub>2</sub> O <sub>2</sub>	Powder	Fe(II)	OH <sup>*</sup>
Calcium peroxide	CaO <sub>2</sub>	Powder	None	H <sub>2</sub> O <sub>2</sub> , HO <sub>2</sub> <sup>-</sup>

<sup>a</sup>Those oxidants with an "\*" have been most commonly used for ISCO applications (see Section 1.3).

**Table 1.5. Reactive Species Associated with Oxidant Chemicals (Huling and Pivetz, 2006)**

Reactive species	Formula	Standard reduction potential (V)
Hydroxyl radical	OH <sup>*</sup>	+2.8
Sulfate radical	SO <sub>4</sub> <sup>*-</sup>	+2.6
Ozone	O <sub>3</sub>	+2.1
Persulfate anion	S <sub>2</sub> O <sub>8</sub> <sup>2-</sup>	+2.1
Hydrogen peroxide	H <sub>2</sub> O <sub>2</sub>	+1.77
Permanganate anion	MnO <sub>4</sub> <sup>-</sup>	+1.7
Perhydroxyl radical	HO <sub>2</sub> <sup>*</sup>	+1.7
Oxygen	O <sub>2</sub>	+1.23
Hydroperoxide anion	HO <sub>2</sub> <sup>-</sup>	-0.88
Superoxide radical	O <sub>2</sub> <sup>*-</sup>	-2.4

Source: Siegrist, Crimi, Simpkin, 2011

Radicals – atoms or compounds with unpaired electrons, usually highly reactive.



Figure 1.11. Photographs illustrating some of the conditions and infrastructure at sites where ISCO has been deployed for groundwater remediation. Image captions give oxidant used, delivery method, and target contaminants. Note: CB - chlorobenzene, MGP - manufactured gas plant.

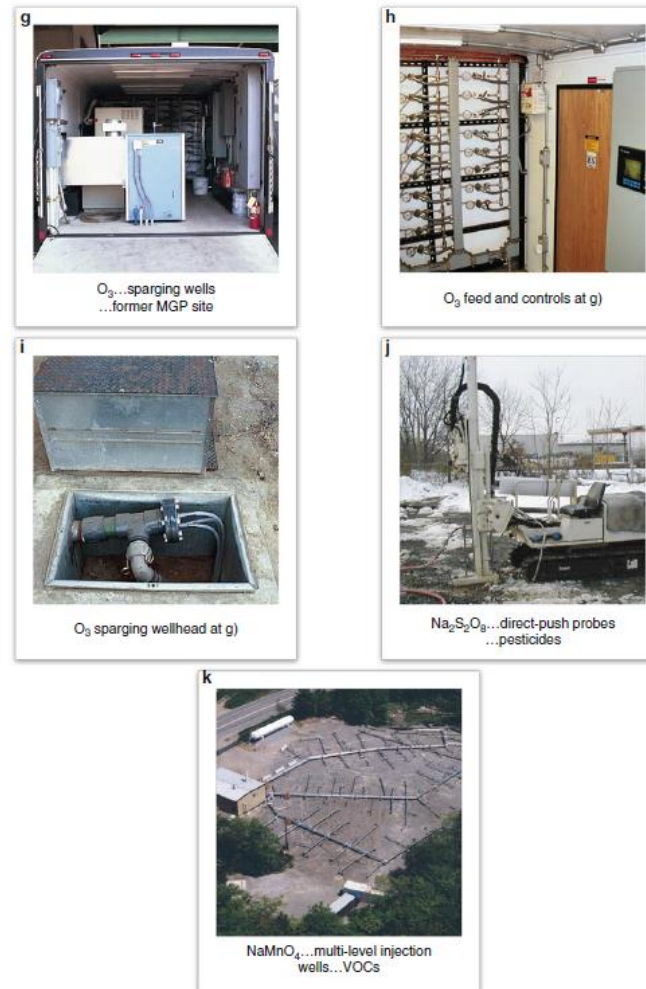

Figure 1.11. (Continued)

## Catalyzed hydrogen peroxide $\text{H}_2\text{O}_2$ (CHP)

In 1894, J.H. Fenton found that  $\text{Fe}^{2+}$  ions are strong catalyst of oxidation reactions with diluted hydrogen peroxide in mildly acidic conditions. This reaction produces hydroxyl radicals  $\text{HO}^\bullet$  of very strong oxidizing properties:



(Also other reactive species). This reaction has been widely applied in wastewater treatment.

**In soil**, the chemistry of reactions with hydrogen peroxide is much more complex. Catalysts include:

- dissolved iron species
- natural minerals (iron and manganese minerals)
- chelated metals (organo-metallic complexes).

Hydrogen peroxide is little direct reactive towards organic compounds, but it is highly reactive with inorganic compounds (oxidation and reduction).

## Catalyzed hydrogen peroxide $\text{H}_2\text{O}_2$ (CHP)

**Table 2.2. Reactive Species Known or Suspected of Contributing to CHP Reactions**

Species	Species formula	Standard reduction potential (V) <sup>a</sup>	pH where present <sup>b</sup>	Role
Hydrogen peroxide	$\text{H}_2\text{O}_2$	1.776	pH < 11.6	Strong oxidant, weak reductant
Hydroxyl radical	$\text{OH}^\bullet$	2.59	pH < 11.9	Strong oxidant
Superoxide anion	$\text{O}_2^{\bullet -}$	-0.33	pH > 4.8	Weak reductant
Perhydroxyl radical	$\text{HO}_2^\bullet$	1.495	pH < 4.8	Strong oxidant
Hydroperoxide anion	$\text{HO}_2^-$	0.878	pH > 11.6	Weak oxidant, weak reductant
Ferryl ion [Fe(IV)]	$\text{FeO}^{2+}$	Unknown	Unknown	Strong oxidant
Solvated electrons	$e^- (\text{aq})$	-2.77	pH > 7.85	Strong reductant
Singlet oxygen	$^1\text{O}_2$	Not applicable	Unknown	Participates in Diels–Alder and Ene reactions
Atmospheric (triplet) oxygen	$\text{O}_2$	1.23	Any	Weak oxidant

<sup>a</sup>Lide (2006).

<sup>b</sup>Buxton et al. (1988).

Source: Siegrist, Crimi, Simpkin, 2011

Rate of radical production and their reactivity is pH-dependent.



## Catalyzed hydrogen peroxide H<sub>2</sub>O<sub>2</sub> (CHP)

185

Cycling (continuous regeneration) of catalyst – dissolved iron (Haber-Weiss mechanism):

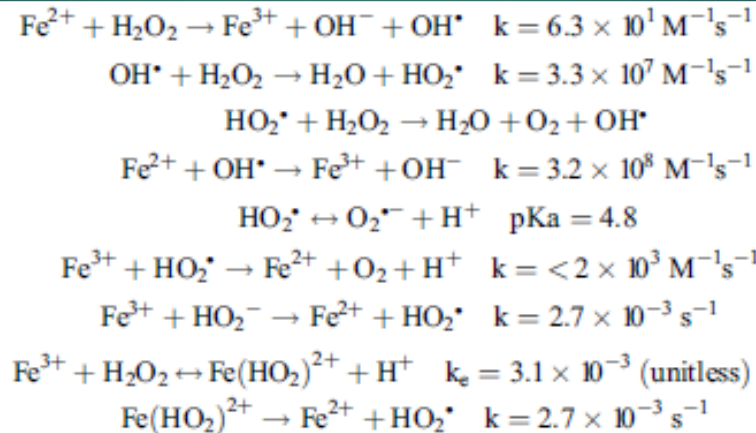

Source: Siegrist, Crimi, Simpkin, 2011

Theoretically, 1/3 of peroxide is used for the regeneration of ferrous ions; 3 moles of oxygen are formed per mole of peroxide.

Influence of pH – >5 of pH Fe<sup>3+</sup> may precipitate, e.g. in the colloidal form, breaking the catalysis cycle and causing decomposition of hydrogen peroxide into water and oxygen without formation of hydroxyl radicals.

In wastewater applications, ferrous ions are introduced into the acidified medium (pH 3–5), then the reagents are dosed.

## Catalyzed hydrogen peroxide $H_2O_2$ (CHP)

In soil remediation, such a procedure is difficult due to buffering properties of groundwater (typical pH 6-8), mainly by carbonates (problems: "rebound" of pH, formation of large amounts of  $CO_2$  during neutralization).

3 strategies are applied:

- conventional: groundwater acidification to pH 3–5, then short peroxide injections. After "rebound" of pH, repeating the acidification-oxidation cycle until the goal is achieved. Another possibility – supplementing iron (II) losses (as a result of iron (III) precipitation); disadvantages – a large volume of injection, the possibility of reducing the hydraulic conductivity by precipitated iron
- iron chelation: the use of chelating agents to keep the iron in dissolved form. Organic compounds are used, e.g. nitrilotriacetic acid, citric acid. EDTA, cyclodextrins and inorganic acids, e.g. pyrophosphate ions
- catalyzed by iron or manganese minerals: based on the initiation of the formation of radicals by iron-containing minerals, e.g.  $\alpha$ -FeOOH goethite. Efficiency requires pilot testing with peroxide injection.

## Catalyzed hydrogen peroxide $\text{H}_2\text{O}_2$ (CHP)

Competing nonproductive reactions (losses of  $\text{H}_2\text{O}_2$ ):

- oxidation of natural organic matter (NOM)
- carbonates and bicarbonates



- chloride, sulphate, etc.
- other reactions, including hydrogen peroxide itself



## Catalyzed hydrogen peroxide $H_2O_2$ (CHP)

### Production of gases:

- carbon dioxide  $CO_2$  from the reaction with contaminants, NOM and carbonates; also as a result of decomposition of carbonates during acidification)
- oxygen  $O_2$  as a result of the decomposition of peroxide in contact with ferric iron and minerals

### Effects:

- displacement of pore water reduces the hydraulic conductivity of the soil, thus reducing the radius of influence; transient effect
- the possibility of a significant increase in pressure in the aeration zone; enhancement of oxidant transport
- stripping of volatile organic contaminants – uncontrolled emissions
- also increasing risk in case of flammable pollutants

## Catalyzed hydrogen peroxide $H_2O_2$ (CHP)

CHP reactions are exothermic and raise temperature of soil and groundwater. Recorded temperatures: rise from 30 to 70°C, even more.

Effects:

- may affect reaction rates
- may affect biodegradation
- generation of steam (gases)

# Catalyzed hydrogen peroxide $\text{H}_2\text{O}_2$ (CHP)

190

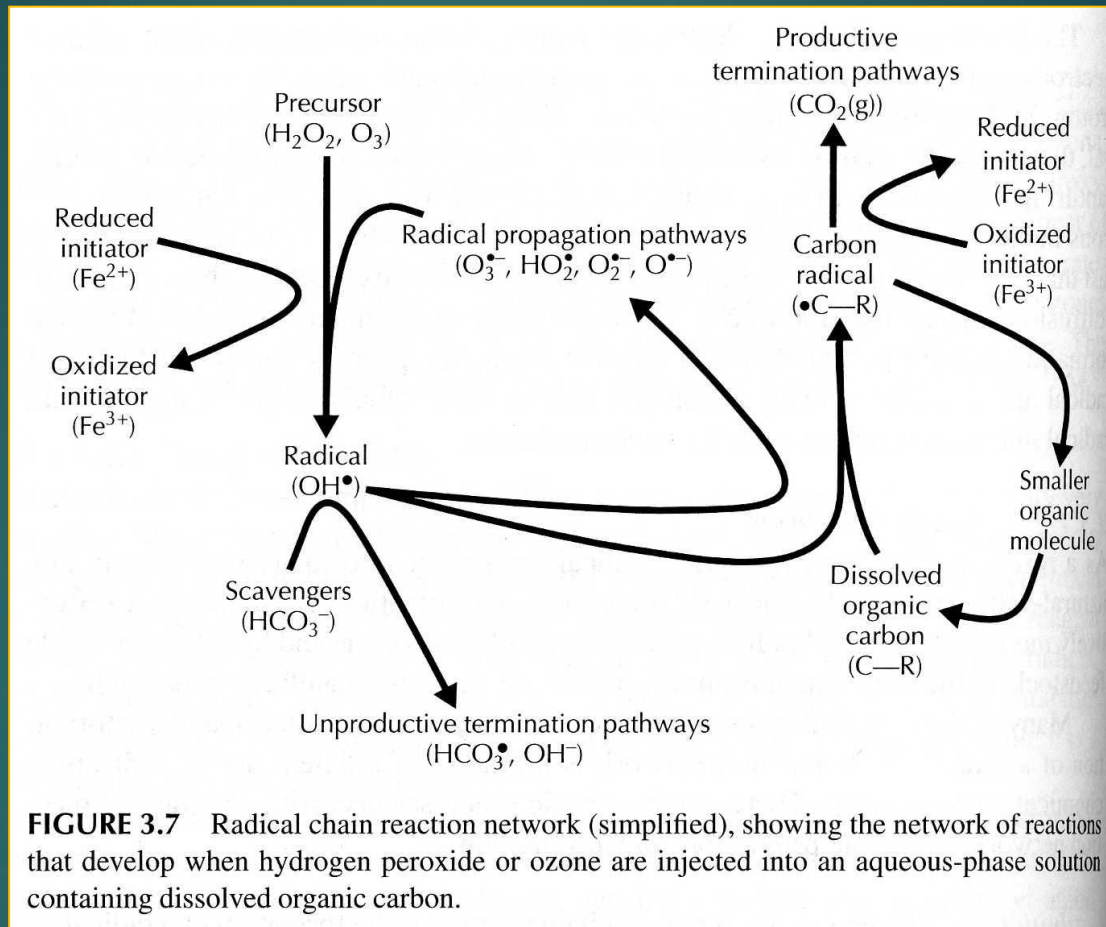

**FIGURE 3.7** Radical chain reaction network (simplified), showing the network of reactions that develop when hydrogen peroxide or ozone are injected into an aqueous-phase solution containing dissolved organic carbon.

Source: Suthersan, Payne, 2004

Short lived but vigorously reacting oxidant, with a typical lifetime of hours to days. This limits its reactive transport in the subsurface.

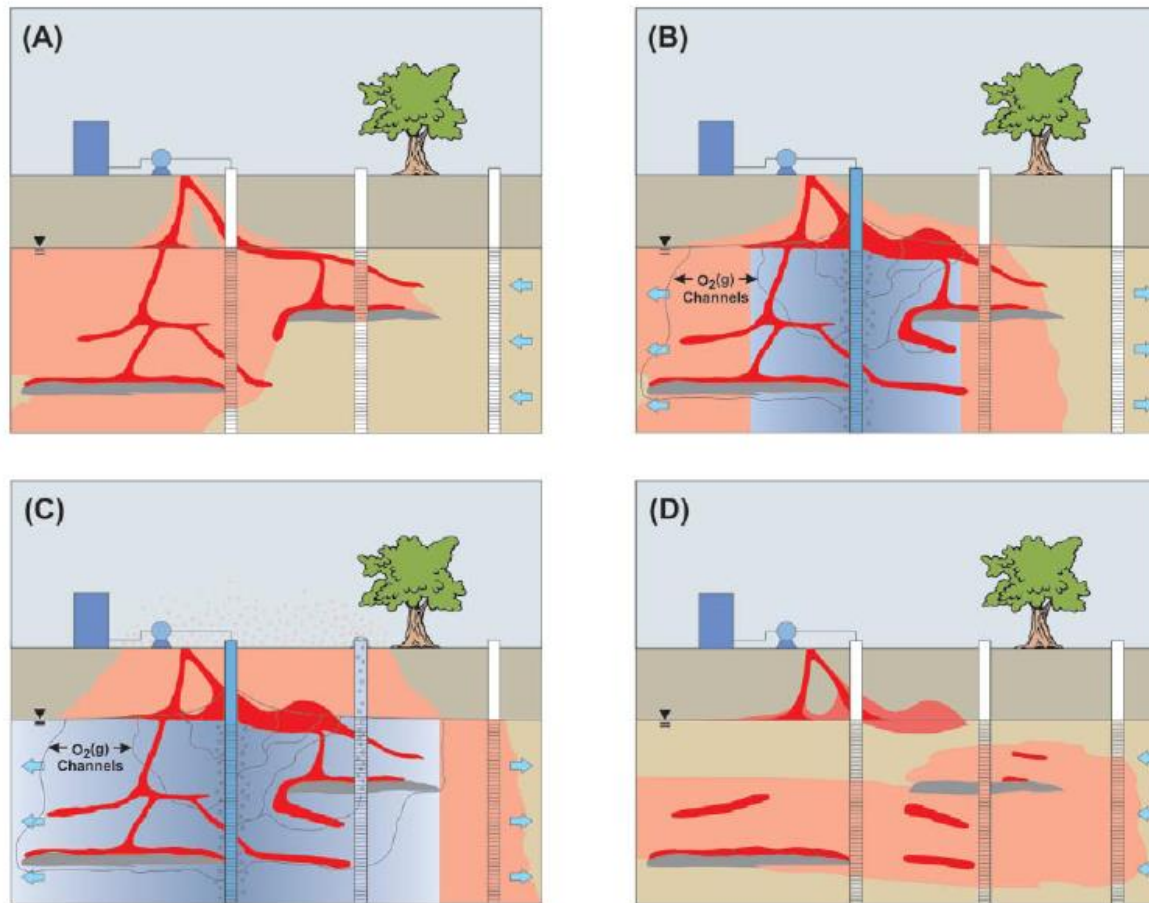

**Figure 8.** Conceptual model of in-situ Fenton oxidation and potential fate and transport mechanisms. (A) Cross-section of hazardous waste site containing DNAPL in the saturated and unsaturated zones. Injection well is constructed in the source area and two monitoring wells located in the upgradient direction (downgradient monitoring wells not shown); (B)  $H_2O_2$  is injected and reacts producing heat and  $O_2(g)$ . Contaminants are transformed via oxidation and other possible mechanisms (reductive transformation, hydrolysis). The pneumatic pressure from the  $O_2(g)$  and from  $H_2O_2$  injection results in mounding of the ground water and displacement of the ground water away from the injection point. DNAPL movement, and enhanced volatilization of contaminants by  $O_2(g)$  sparging + heat may also occur; (C)  $O_2(g)$  sparging of the ground water in monitoring wells, artesian conditions, and continued ground-water displacement and enhanced volatilization may occur; (D)  $H_2O_2$  injection ceases and is fully reacted. Loss of the target contaminant(s) in the source zone is achieved by oxidation transformation but may not be differentiated from other fate and transport mechanisms. Contaminant mass transfer and transport results in rebound.

# Catalyzed hydrogen peroxide H<sub>2</sub>O<sub>2</sub> (CHP)

**Table 2.7. Susceptibility of Different Organic Compounds to Oxidative Degradation by CHP**

Contaminant category	Number of aqueous system studies	Number of soil-slurry system studies	Treatability
<b>Chlorinated aliphatic compounds</b>	<b>15</b>	<b>19</b>	
Chloroethenes	3	5	Degradable
Chloroethanes	6	0	Conditionally degradable
Chloromethanes	2	1	Conditionally degradable
Other	14	7	Conditionally degradable
<b>Chlorinated aromatic compounds</b>	<b>24</b>	<b>14</b>	
Chlorophenols	14	7	Degradable
Chlorobenzenes	2	1	Degradable
Polychlorinated biphenyls (PCBs)/ dioxins/furans	7	6	Conditionally degradable
Other	1	0	Conditionally degradable
<b>Hydrocarbon compounds</b>	<b>25</b>	<b>22</b>	
Benzene, toluene, ethylbenzene, and total xylenes (BTEX)	1	3	Degradable
Total petroleum hydrocarbons (TPH) and saturated hydrocarbons	0	9	Degradable
Methyl tert-butyl ether (MTBE)	4	1	Conditionally degradable
Phenolic compounds	10	1	Degradable
Polycyclic aromatic hydrocarbons (PAHs)	8	8	Conditionally degradable
Other	2	0	Conditionally degradable
<b>Other organic compounds</b>	<b>37</b>	<b>22</b>	
Explosives and nitroaromatic compounds	8	5	Degradable
Pesticides	8	4	Conditionally degradable
Other	21	13	Conditionally degradable
<b>Total studies</b>	<b>74</b>	<b>59</b>	



## Permanganate $\text{MnO}_4^-$

Used as water solution of potassium salt (up to 6% concentration) or sodium salt (up to 40% concentration).

Relative simple reaction chemistry; direct electron transfer rather than through radicals:

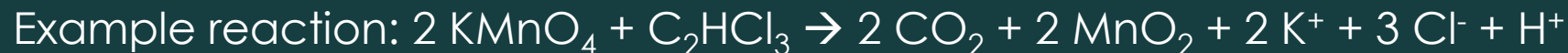
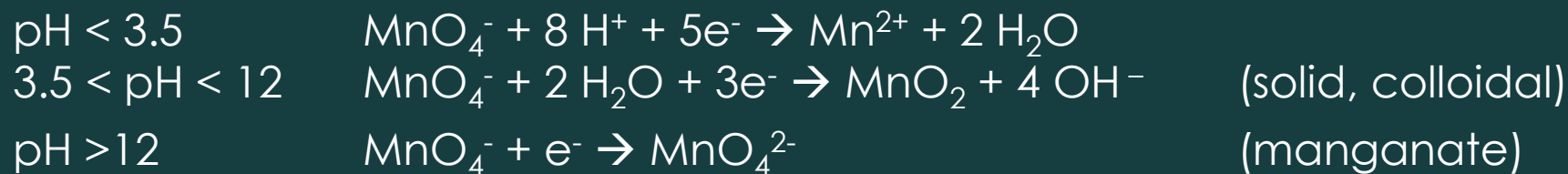

Most often occurring subsurface conditions: neutral to slightly acid; however, permanganate works over wide pH range (advantage)

Less reactive than CHP, more stable

# Permanganate $\text{MnO}_4^-$

194

Works well on alkene (double) bonds, less reactive with alkane

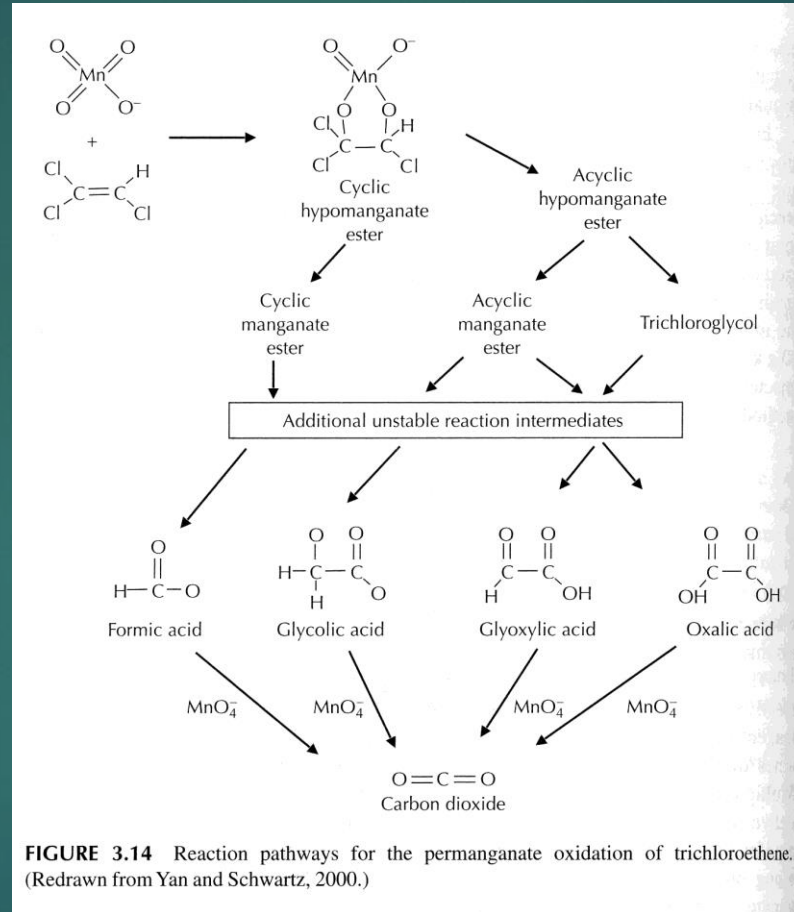

Source: Suthersan, Payne, 2004

Reactivity with aromatic compounds depends on structure (e.g. presence of functional groups).

## Permanganate $\text{MnO}_4^-$

Under common conditions (low pH, high redox) production of dark brown manganese dioxide  $\text{MnO}_2$  – colloidal, but then agglomerating.

### Effects:

- changing hydraulic conductivity and permeability, which can alter reactive transport of permanganate
- causing high backpressures – problems with injection equipment
- $\text{MnO}_2$  is reactive – possible abiotic reactions with some contaminants, but also can catalyze permanganate autodecomposition (usually not significant). Can rapidly decompose hydrogen peroxide
- may act as a sorbent for metal cations.

Degradation of organic compounds cause evolution of  $\text{CO}_2$  gas – may dissolve, changing pH. Generally less than for CHP or ozone, but it also can alter flow and transport.

## Permanganate $\text{MnO}_4^-$

Natural oxidant demand (NOD) – consumption of permanganate in reactions with natural organic matter (NOM) (major contribution), inorganic species and solutes – nonproductive oxidant sink.

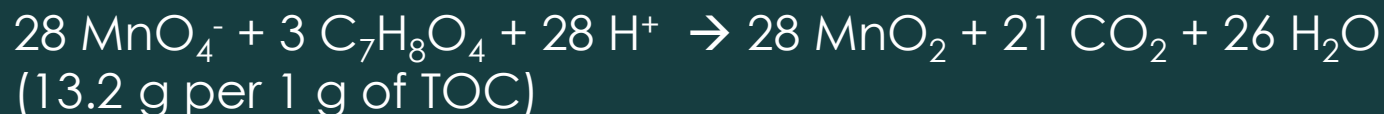

Must be determined experimentally (lab or field tests, e.g. push and pull).

NOD magnitude depends on soil type, NOM content. It may be between 0–20 g  $\text{MnO}_4^-$ /kg dwt and more (mostly 0.5–2 g  $\text{MnO}_4^-$ /kg dwt).

In practice, large excess of permanganate is needed (over 5 stoichiometrically + NOD).

**Table 3.3. General Assessment of the Treatability of Different Organic Compounds by Permanganate ISCO**

Contaminant group	Section <sup>a</sup>	Contaminant treatability by permanganate?	Comments
<b>Chlorinated aliphatic compounds</b>			
Chloroethenes	3.4.1	High	Chloroethenes are degraded readily with permanganate. Compounds like PCE and TCE have been extensively studied and the mechanisms and products are well understood
Chloroethanes	3.4.2	Negligible	Due to saturated nature of these compounds (e.g., 1,1,1-trichloroethane [1,1,1-TCA]; 1,1-dichloroethane [1,1-DCA]) they do not react readily with permanganate
Chloromethanes	3.4.2	Negligible	Due to the saturated nature of these compounds (e.g., carbon tetrachloride [CT]) they do not react readily with permanganate
<b>Chlorinated aromatic compounds</b>			
Chlorophenols	3.4.4	High	Isomers of chlorophenol react readily with permanganate at rates that are 10 to 100x faster than most chloroethenes
Polychlorinated biphenyls/dioxins/furans	3.4.5	No	Based on compound structure and studies to date, these compounds do not react with permanganate
<b>Hydrocarbon compounds</b>			
Benzene, toluene, ethylbenzene, and total xylenes (BTEX)	3.4.3	Conditional	Benzene is almost nonreactive, but the other BTEX compounds can be degraded but at rates that are 10 to 100x slower than for PCE
Saturated aliphatic hydrocarbons	3.4.3	Negligible	Due to the saturated nature of these compounds and their low aqueous solubility, they do not react readily with permanganate
Methyl tert-butyl ether (MTBE)	3.4.3	Negligible	Reaction rates are much lower than chloroethenes
Phenolic compounds	3.4.4	High	Phenols and isomers of chlorophenol react readily with permanganate at rates that are 10 to 100x faster than most chloroethenes; isomers of nitrophenol react at rates similar to chloroethenes
Polycyclic aromatic hydrocarbons (PAH)	3.4.5	Conditional	Reactivity of PAHs with permanganate varies widely depending on compound structure and conditions
<b>Other organic compounds</b>			
Explosives and nitroaromatic compounds	3.4.6	Conditional	Reactivity with permanganate varies widely depending on compound structure and conditions. For some degradation has been shown, though at very slow rates; nitrophenols are rapidly degraded.
Pesticides	3.4.7	Uncertain	Degradation has been observed for a few compounds, but limited studies have been done

<sup>a</sup>The number refers to the Section within this chapter where information on the treatability of each respective contaminant group is discussed.

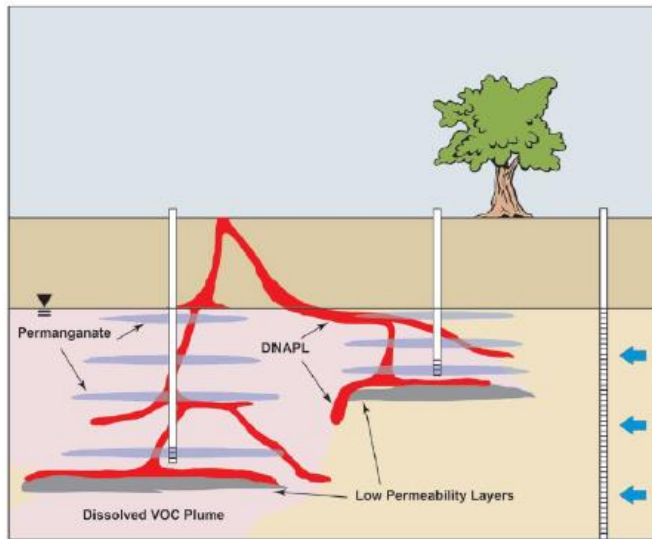

**Figure 6.** In-situ permanganate oxidation involving the emplacement method of oxidant delivery. Direct push technology can be used to inject the permanganate solution over short-screened intervals. Delivery of the oxidant over short-screened intervals can reduce the displacement of contaminated ground water relative to injection over longer-screened intervals. Stacked, intermittent layers (5 to 15 ft) of oxidant will disperse vertically and laterally with time.

Source: Huling, Pivetz, 2006

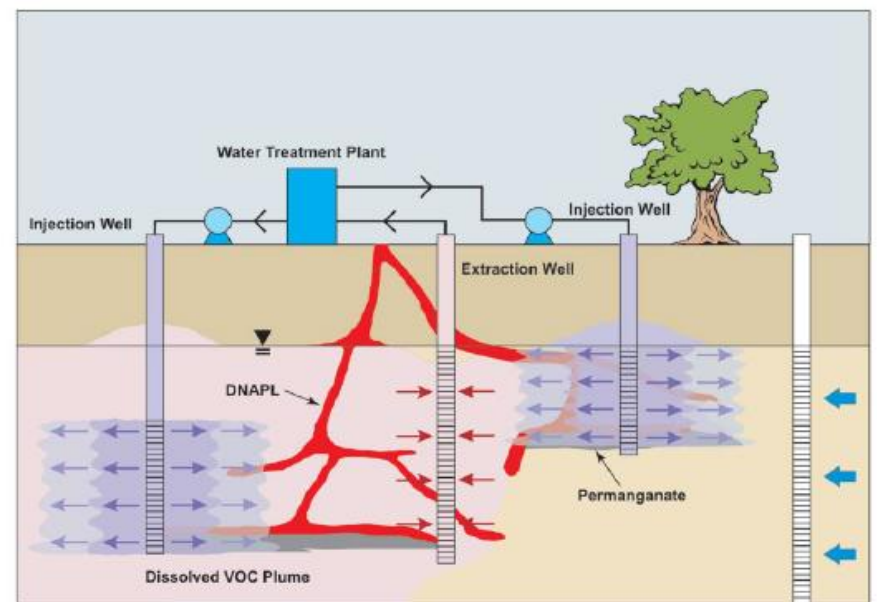

**Figure 7.** In-situ permanganate oxidation involving the recirculation method. Injection and extraction wells are used to deliver and recover the oxidant solution. Above-ground treatment is required to remove particulate matter (i.e.  $MnO_2(s)$ , sand, silicates) and possibly COCs/ VOCs, and to re-amend the ground water with permanganate before re-injection.

## Ozone O<sub>3</sub>

199

Tri-molecular oxygen, highly reactive and unstable gas – cannot be stored; must be generated on-site.

Most common method: corona discharge method, where ozone is produced from air or pure oxygen passed between two electrically charged plates.

Pure oxygen gas may also be generated onsite from air:

- air: production of about 1% ozone,
- oxygen: 4–10% ozone.

Generation requires much electrical power, efficiency of generators is limited.

**Injected as gas**, can be delivered to vadose zone or sparged into saturated zone; additional benefits:

- stripping of volatile organic contaminants (VOC),
- generation of oxygen (stimulation of biodegradation), also delivered as co-injectant.

# Ozone O<sub>3</sub>

200

Can act both in gas and aqueous phase

- direct oxidation; e.g. cyclo-addition of ozone to alkene bond, electrophilic addition on aromatic ring
- radicals

(several models of decomposition)

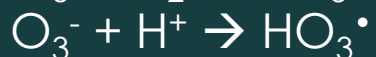
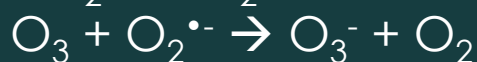

Influence of pH: in acidic conditions, direct oxidation dominates, unless catalysts are present.

Table 5.2. Reactive Species Suspected or Known Within Ozone Oxidation Systems

Species	Standard Reduction Potential (V)	Properties
Ozone (O <sub>3</sub> )	2.07 (acid) <sup>a</sup>	Reactive gas and the primary oxidant in ozonation systems. Capable of direct oxidation in addition to the generation of free radicals
Hydroxyl radical (OH <sup>•</sup> )	2.59 (acid) <sup>b</sup> 1.64 (alk) <sup>b</sup>	Strongly oxidizing radical that reacts non-specifically with many organic compounds (e.g., Buxton et al., 1988). This radical has traditionally been viewed as the major workhorse of organic oxidation in ozone systems where free radical generation is favored (Langlais et al., 1991; Beltrán, 2004)
Superoxide anion (O <sub>2</sub> <sup>•-</sup> )	-0.33 (alk) <sup>c</sup>	Conjugate base of the perhydroxyl radical (HO <sub>2</sub> <sup>•</sup> ), with an acid dissociation constant (pK <sub>a</sub> ) of 4.8. <sup>c</sup> and is a reductant. It has recently been implicated in the degradation of highly oxidation-resistant organics in hydrogen peroxide systems via reductive mechanisms (Watts et al., 1999)
Perhydroxyl radical (HO <sub>2</sub> <sup>•</sup> )	1.495 (acid) <sup>a</sup>	Dominant form of superoxide at a acidic pH with a pK <sub>a</sub> of 4.8. <sup>c</sup> It is a weak oxidant but plays a major role in ozone reaction propagations (Langlais et al., 1991)
Hydroperoxide (HO <sub>2</sub> <sup>-</sup> )	0.878 (alk) <sup>a</sup>	Conjugate base of hydrogen peroxide, with a pK <sub>a</sub> of 11.6. <sup>a</sup> Thus, this ion will largely play a role when the pH is in the alkaline range. Tomiyasu et al. (1985) implicated this as having a major role in ozone free radical propagation reactions
Hydrogen peroxide (H <sub>2</sub> O <sub>2</sub> )	1.78 (acid) <sup>a</sup>	A reaction product that may be produced by ozone decomposition reactions, though it is also rapidly decomposed. May also be delivered with ozone in the peroxone process. Decomposes to form radicals, especially OH <sup>•</sup> and O <sub>2</sub> <sup>•-</sup>
Molecular oxygen (O <sub>2</sub> )	1.23 (acid) <sup>a</sup>	A major reaction product of ozone decomposition and also present in gas that delivers ozone to the subsurface. Has the ability to react with organic radicals to form organoperoxides and stimulate aerobic biodegradation
Ozonide (O <sub>3</sub> <sup>-</sup> )	?	Accepted as a major reaction intermediate in the decomposition of ozone into free radicals (Langlais et al., 1991)
Hydrogen trioxide (HO <sub>3</sub> <sup>•</sup> )	?	Proposed by Staehelin et al. (1984) as a reactive radical intermediate involved in ozone propagations. This is also the protonated form of ozonide (O <sub>3</sub> <sup>-</sup> )
Hydrogen tetraoxide (HO <sub>4</sub> <sup>•</sup> )	?	Proposed by Staehelin et al. (1984) as a reactive radical intermediate involved in ozone propagations
Trioxidane (H <sub>2</sub> O <sub>3</sub> )	?	Highly reactive oxidant that might be formed as an intermediate in the peroxone process. Decomposes in water to form singlet oxygen (Cerkovnik and Plesničar, 1993)
Singlet oxygen ( <sup>1</sup> O <sub>2</sub> )	?	A high-energy form of molecular oxygen that may react with certain organics to degrade them (Kanofsky et al., 1988)



Peroxone (or Perozone) – application of ozone together with hydrogen peroxide

Higher rate of radicals generation, especially hydroxyl radical

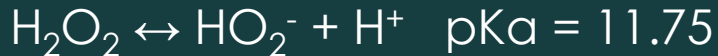

Hydroperoxide anion – decomposition of ozone increases at higher pH

Oxidation of NOM: 5.4 g of ozone per g of NOM

Also possible interactions with other soil constituents:

- minerals
- dissolved solutes: carbonate, bicarbonate, sulphate etc.

Scavengers (e.g. catalytic decomposition), but also radicals (less reactive) can be formed

# Uniform contact with contaminants challenging in saturated zone

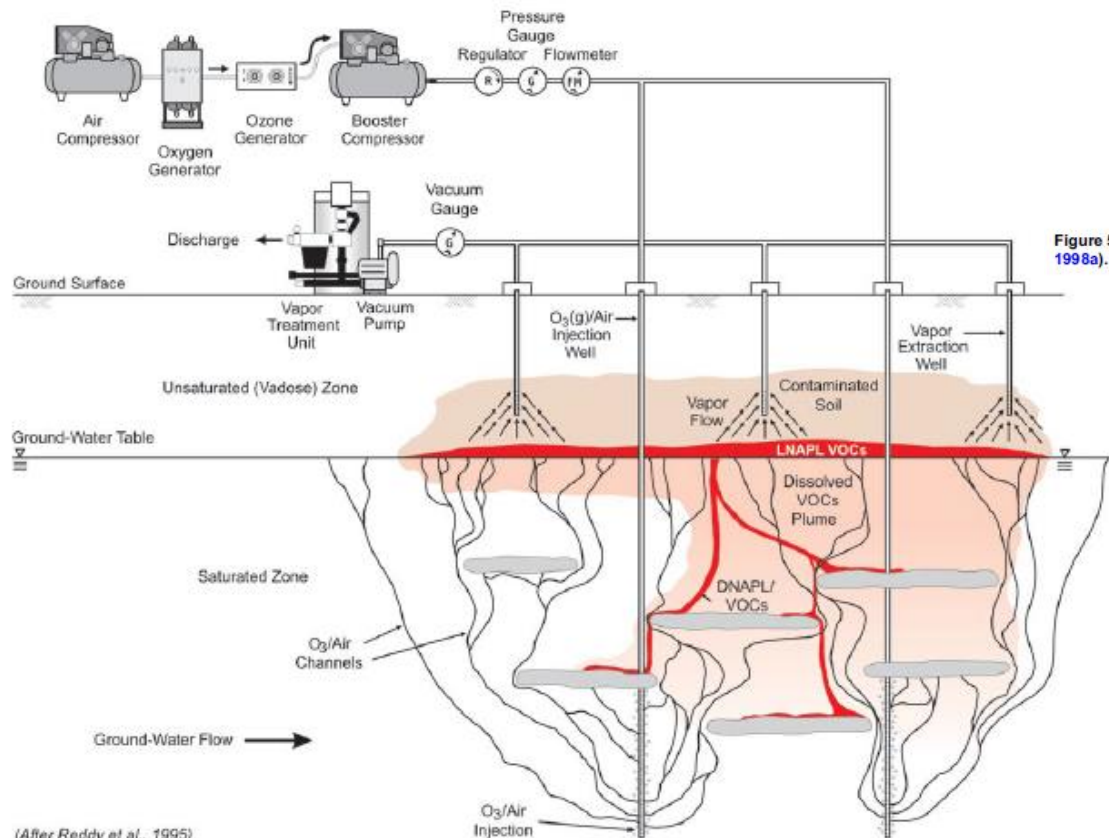

(After Reddy et al., 1995)

**Figure 1.** General conceptual model of in-situ ozonation in the saturated zone with soil vacuum extraction to capture volatile emissions and O<sub>3</sub>(g). On-site O<sub>3</sub> generation and injection into the ground water results in oxidation of ground-water contaminants and other reduced chemical species. O<sub>3</sub>/air sparging results in the formation of O<sub>3</sub>/air channels which contact a small cross-section of the aquifer. Close spacing of injection wells is required to accomplish a high density of air channels for adequate distribution of the oxidant.

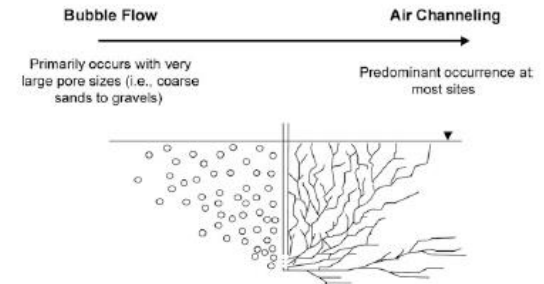

**Figure 5.4.** Idealized differences between bubble flow and air channeling (modified from Clayton, 1998a).

Source: Huling, Pivetz, 2006

Table 5.5. General Assessment of the Treatability of Different Organic Compounds by Ozone ISCO

Contaminant group	Section <sup>a</sup>	Contaminant treatability by ozone?	Comments
Chlorinated aliphatics (e.g., PCE, TCE, 1,1,1-trichloroethane [1,1,1-TCA])	5.4.1	Yes	Mechanisms, rates, and products well-understood and documented
1,4-Dioxane	5.4.1	Yes	Potential for organic acid and alcohol intermediates, depending on radical propagation mechanisms involved
Chlorinated aromatics (e.g., chlorobenzene, dichlorobenzene, chlorophenol)	5.4.2	Yes	Mechanisms, rates, and products well-understood and documented
Fuel hydrocarbons (e.g., BTEX, TPH)	5.4.3	Yes	Mechanisms, rates, and products well-understood and documented
MTBE	5.4.3	Yes	Transient production of tert-butyl alcohol (TBA), which is subsequently treated at a slower rate than MTBE
PAHs (e.g., benz[a]anthracene, benzo[a]pyrene, pyrene, anthracene)	5.4.4	Yes	Mechanisms, rates, and products well-understood and documented
Nitroamine and nitroaromatic explosives (e.g., hexahydro-1,3,5-trinitro-1,3,5-triazine [RDX], nitrotoluene, 2,4,6-trinitrobenzene (TNT), nitrobenzene)	5.4.5	Yes	Mechanisms, rates, and products well-understood and documented
Pesticides (e.g., organochlorines, organophosphates)	5.4.6	Potentially	Fairly limited data available, although encouraging preliminary results

## Persulphate $S_2O_8^{2-}$

Peroxydisulphate; applied as water solution of sodium persulphate (potassium salt to low solubility, ammonium salt produces ammonium/nitrate).

Complex chemistry:

- direct oxidation



- radicals – formed upon activation (sulphate radical  $SO_4^{\bullet-}$  and hydroxyl radical  $OH^{\bullet}$ , also others)

## Methods of activation:

- heat 30-60°C; produces sulphate radicals
- by dissolved iron and other transition metals; works at low pH (pH 3)



- by chelated metals;  $Fe^{2+}$  complexed by ethylenediaminetetraacetic acid (EDTA) or citrate, allows for catalysis at neutral pH
- by hydrogen peroxide (decomposes at alkaline and neutral pH)  
unclear mechanism: heat?, hydroxyl radicals?
- by alkaline conditions; addition of hydroxides to raise pH to 11–12



Sulphate radicals dominate at low pH 2–4, while hydroxyl radicals prevail at high pH 7–9.

## Persulphate $S_2O_8^{2-}$

### Byproducts:

- sulphate ( $SO_4$ ); increases salinity, also electron acceptor for sulphate reducing bacteria (SRB)
- pH drop: production of protons ( $H^+$ ) in reactions, acids as products of contaminants degradation – magnitude depends of buffering capacity of aquifer; may cause problems at alkaline activation
- carbon dioxide from contaminants degradation; oxygen when activated with peroxide.

## Persulphate $S_2O_8^{2-}$

### Scavengers (unproductive reactions):

- carbonate and bicarbonate: react with free radicals; at metal activation produce metal complexes and precipitates, which can slow down oxidant decomposition and contaminants degradation; may form radicals but of lower reactivity – overall negative effect
- chloride: as above; may form chlorinated intermediates
- NOM (natural organic matter)
- some minerals may act as catalysts, but more research is necessary.

## Persulphate $S_2O_8^{2-}$

**Table 4.7. General Assessment of the Susceptibility of Classes of Organic Contaminants to Persulfate ISCO**

Contaminant group	Susceptible to persulfate oxidation	Notes
Halogenated aliphatics	Yes; dependent on contaminant type	Chloroethenes highly amenable; chloroethanes less amenable; chloromethanes amenable only with very aggressive activation approaches
Chlorinated aromatics	Yes; limited data but highly probable	Little published data, but existing data do indicate high amenability for most chlorinated aromatics; oxidation of aromatics with more complex structures highly dependent on activation approach
Fuel hydrocarbons	Yes; dependent on persulfate activation approach	Oxidation of hydrocarbons with more complex structures highly dependent on activation approach
Polycyclic aromatic hydrocarbons	Yes; dependent on persulfate activation approach	Oxidation of hydrocarbons with more complex structures highly dependent on activation approach; little info available on individual component amenability
Nitroorganics	Yes; some are more amenable than others	2,4,6-Trinitrotoluene (TNT) appears to be more amenable than dinitrotoluene (DNT); limited data
Pesticides	Possibly	Limited data; likely dependent on structural complexity and activation approach



- Peroxide: very strong oxidant; potential for NA enhancement; most unstable – short lifetime, limited transport; production of heat and gases; intensively studied
- Permanganate: most developed; persists for long periods of time – penetrates into low-permeability materials, greater transport distances;  $\text{MnO}_2$  precipitation; high natural oxidant demand
- Ozone: difficult to handle, also health risk; may be applied both in vadose and saturated zone; restricted transport in saturation zone; gas emissions; limited application number
- Persulphate: relatively new, limited applications; quite stable (however, less than permanganate) – potential for better penetration; less reactive with NOM than permanganate

Specific reactivity towards different contaminants. e.g. benzene.

## Remediation by chemical methods: reduction

### Reducers:

- metallic (zero-valent) iron: powdered, micro- and nanoscale
- $\text{Fe}^{2+}$
- dithionite
- cyanocobalamine (reduced vitamin B<sub>12</sub>) – research

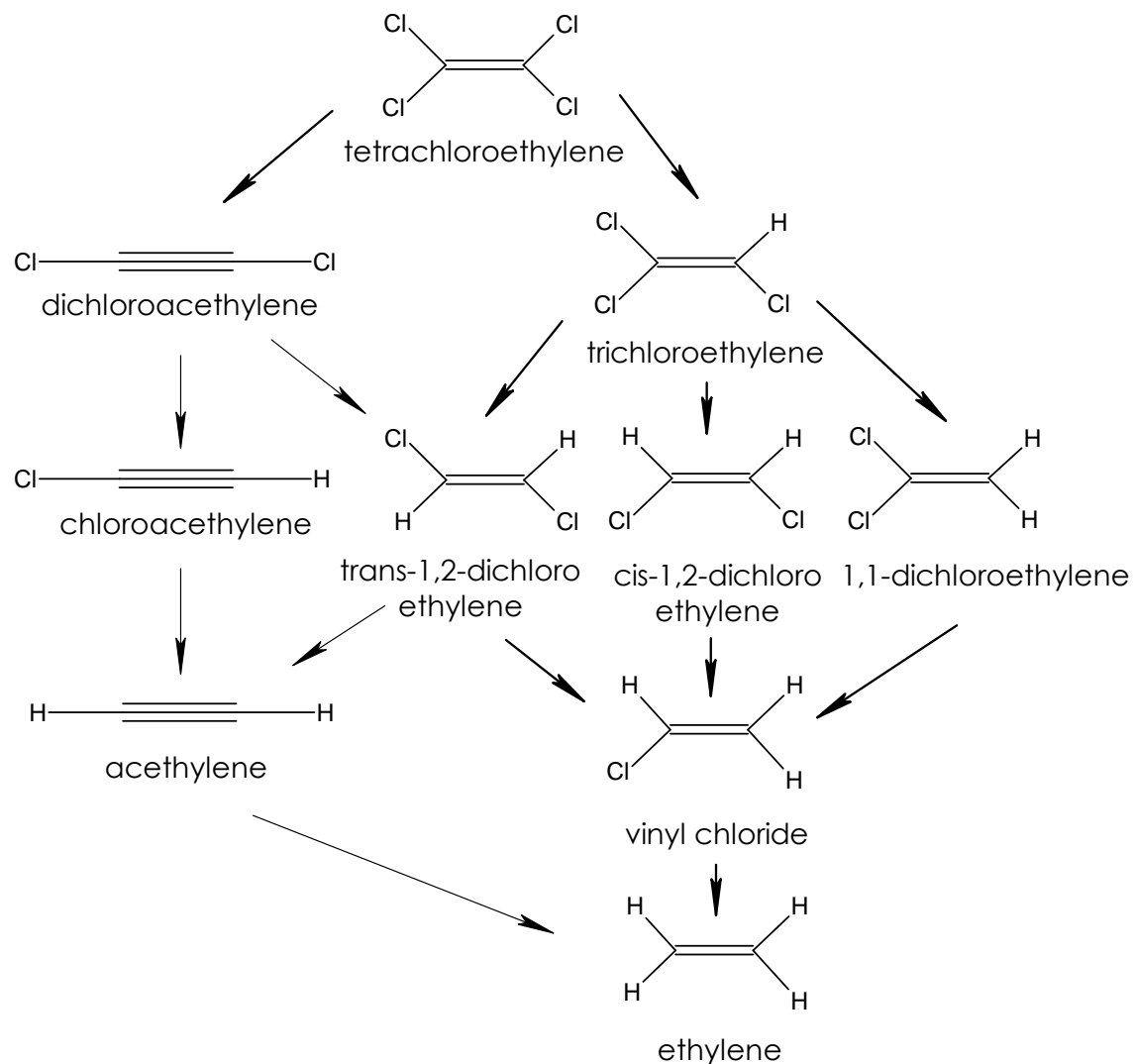

Transformation of organochlorines, reduction of chromium, arsene

## Metallic (zero-valent) iron $\text{Fe}^0$

DARAMEND reagent produced from plant material (waste) and containing 40% fine metallic iron.

Stimulation of biological degradation and abiotic reactions (reduction).

Anaerobic-aerobic cycle:

- anaerobic phase (1–2 weeks): mixing with the preparation 0.5–2%; irrigation to 90% WHC. Dechlorination of compounds
- aerobic phase: multiple plowing; drying or irrigation

Application to a depth of 0.6 m



Source: <http://www.adventusgroup.com>

# Metallic (zero-valent) iron Fe<sup>0</sup>

213

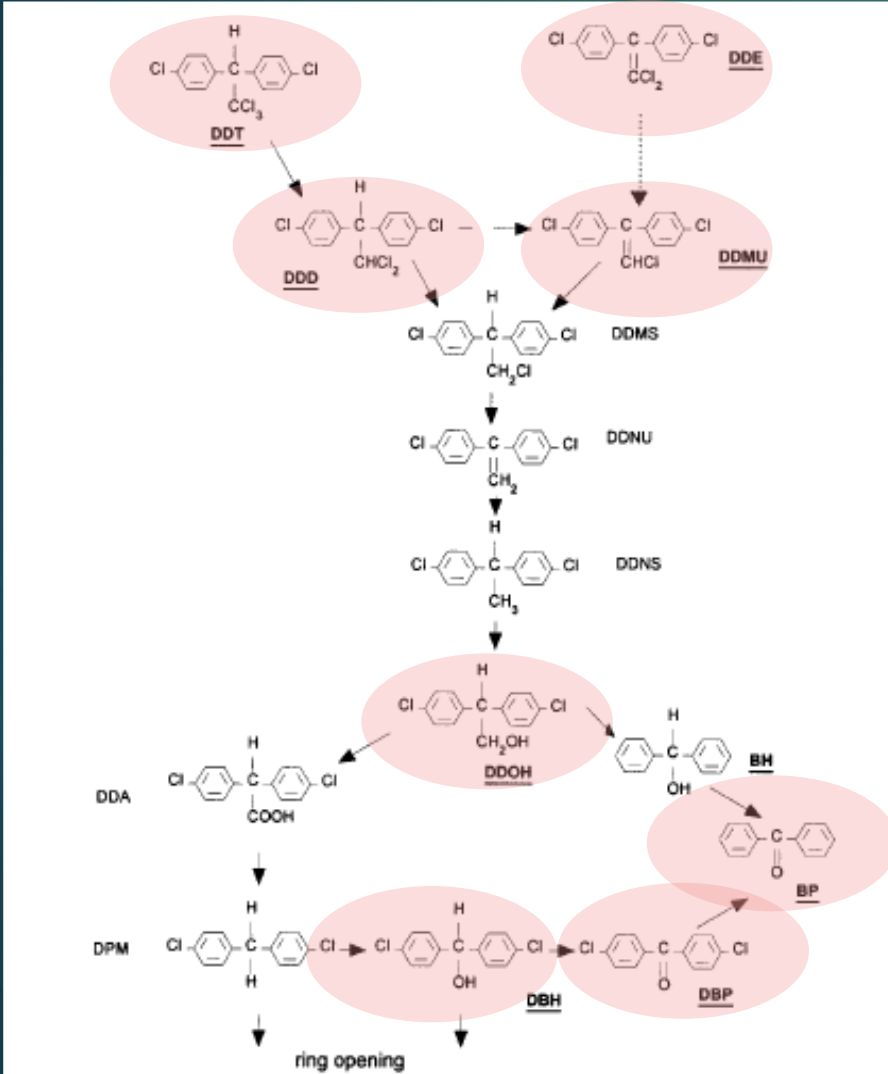

Source: Sayles, You, Wang, Kupferle, 1997

T.H. Agriculture & Nutrition Superfund site (former pesticide formulation area)

2002-4: 4,500 tons of soil, contaminated with DDT, DDD, DDE, toxaphene treated on-site using DARAMEND

12 compartments with an area total 1.1 ha. From 3 to 12 cycles (August 2002–September 2003)

The cost is \$ 55 per ton

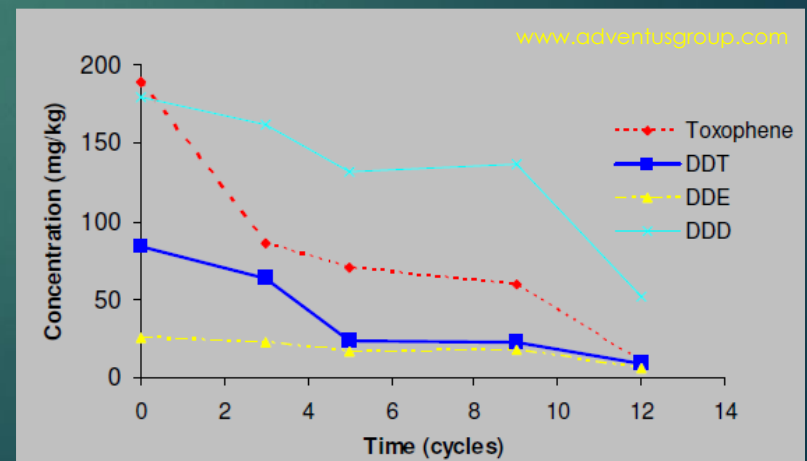

# Metallic (zero-valent) iron Fe<sup>0</sup>

Nanoscale iron – particle size 10–100 (200) nm: high specific surface area, possibility of transport in an aqueous medium (injected as slurry, mixed with water, plant oil). Sometimes as bimetallic particles (catalyst, e.g. palladium)

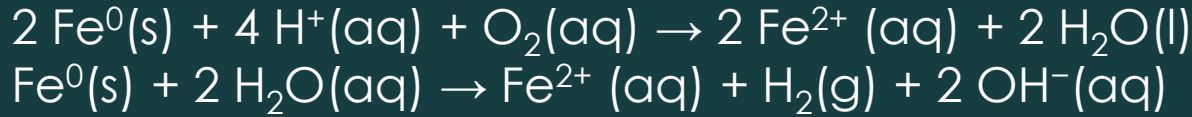

(raising the pH)



Consumption in secondary reactions (oxygen, nitrates, sulphates)

Passivation

Applicability: chlorinated alkenes, chlorinated methanes, chromium, arsenium, some pesticides

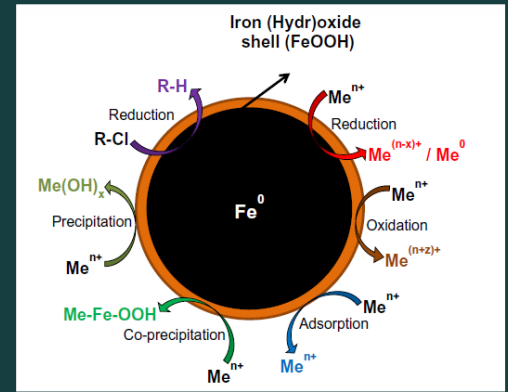

Source: O'Carroll, 2013

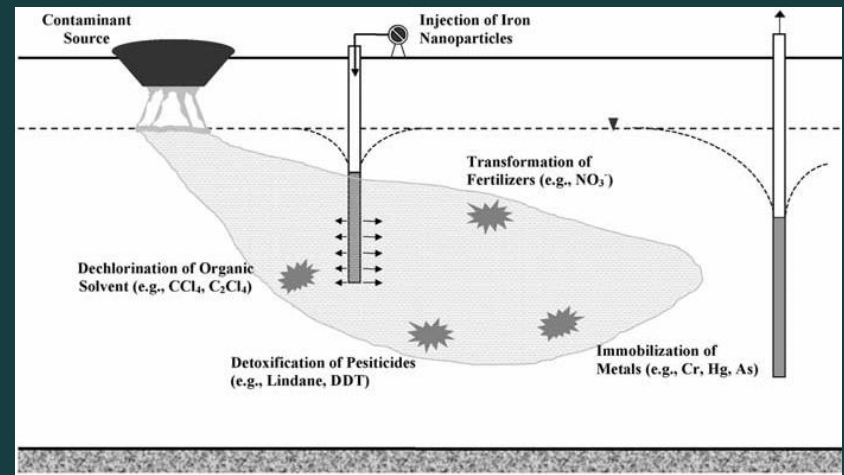

Source: Zhang, 2003

## Dithionite $S_2O_4^{2-}$

215

Used as sodium dithionite: reduction of chromium, organochlorines.

Dissociation of the dithionite anion:

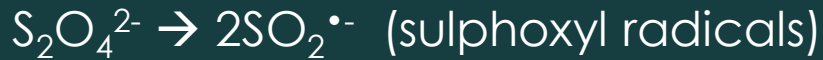

Reaction with oxygen:



Hydrolysis of dithionite:



Sometimes used in combination with iron, also reduction of iron minerals:



## Part 6

# Methods of remediation of soil and groundwater: Natural attenuation and bioremediation



## Natural attenuation

Use of natural processes to contain the spread of the contamination from chemical spills and reduce the concentration and amount of pollutants at contaminated sites (US EPA definition)

Other terms: remediation, bioattenuation, intrinsic bioremediation

Natural processes:

- dilution, dispersion
- volatilization
- immobilization: sorption, humification, ion exchange, precipitation
- radioactive decay
- transformation (degradation): abiotic and biotic

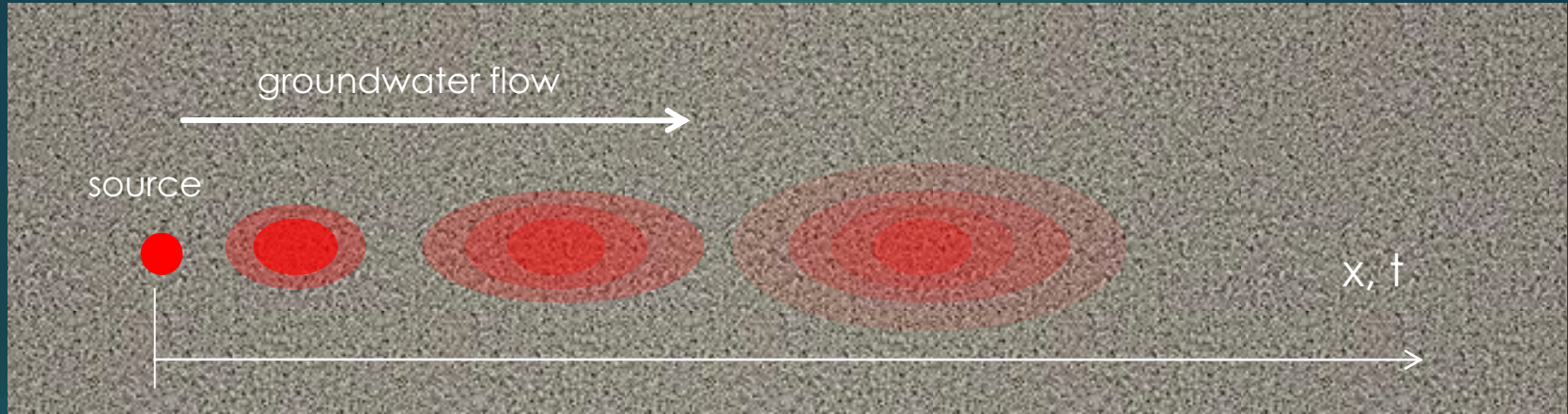

Source: Alvarez, Illman, 2006

## Transport:

- advection: mass transport due to flowing groundwater
- hydrodynamic dispersion:
  - mechanical dispersion: mixing due to microscopic variations in flow velocity in porous medium
  - diffusion: transport of molecules due to concentration gradient
- retardation: decrease of migration velocity due to sorption
- dilution: by infiltration, injection etc. of uncontaminated water

## Natural attenuation: volatilization

Conversion of solid or liquid pollutants into vapours (gas phase)

Henry's law, constant –  $K_H$

$K_H < 3 \times 10^{-7} \text{ atm}\cdot\text{m}^3/\text{mol}$  – nonvolatile (e.g. DDT, phenol, pentachlorophenol, some PAHs)

$K_H > 10^{-3} \text{ atm}\cdot\text{m}^3/\text{mol}$  – volatile (e.g. BTEX, tetrachloroethylene, carbon tetrachloride)

(up to 10% removal of monoaromatic hydrocarbons)

## Natural attenuation: immobilization

- Sorption:
  - absorption – diffusion or partitioning into bulk of soil (e.g. by hydrophobic expulsion of nonpolar organics like PAHs, PCBs)
  - adsorption – accumulation at solid-liquid interface (e.g. by electrostatic attraction and surface coordination reactions; metals, anions)

Sorbents: humic materials (NOM), clays, zeolites, several oxide minerals

- Precipitation: pH increase, excess of co-precipitating ion
- Humification: incorporation of pollutant molecules into soil organic matter (e.g. some PAHs)

## Natural attenuation: abiotic degradation

221

**hydrolysis:** addition of hydrogen and hydroxyl ion from water to a molecule, resulting in splitting into simpler products; influenced by temperature and pH

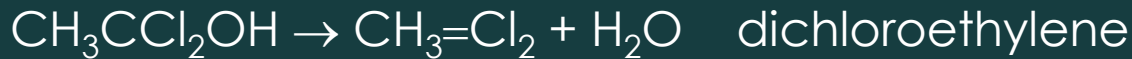

susceptible: alkylhalides, amides, carboxylic acid esters, carbamates, organophosphorus pesticides...

resistant: alkanes, aromatics, alcohols...

**reduction:** gaining electrons, transformation into reduced metabolites

ferrous iron  $\text{Fe}^{2+}$ , dissolved and sorbed; iron-bearing minerals (e.g. magnetite)

sulphites

hydrogenolysis: C-C bond is cleaved by hydrogen

dihaloelimination: loss of 2  $\text{Cl}^-$ , forming a double C=C bond

coupling: loss of 2  $\text{Cl}^-$ , joining two molecules

**dehydrohalogenation:** removal of HCl from molecule



# Natural attenuation: abiotic degradation

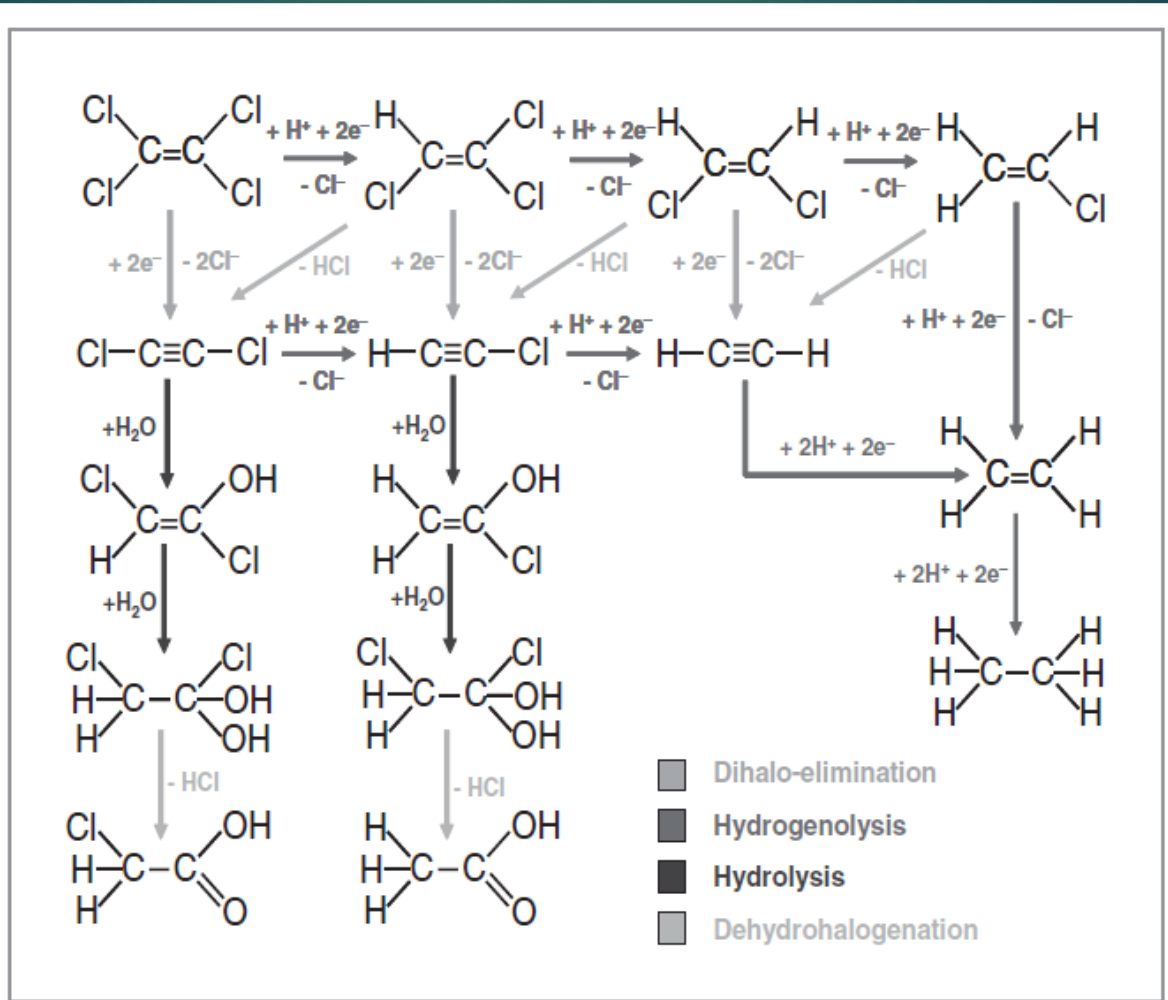
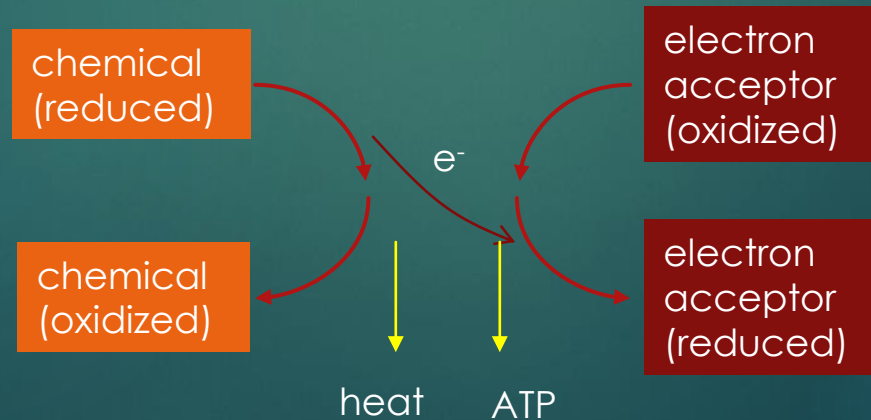
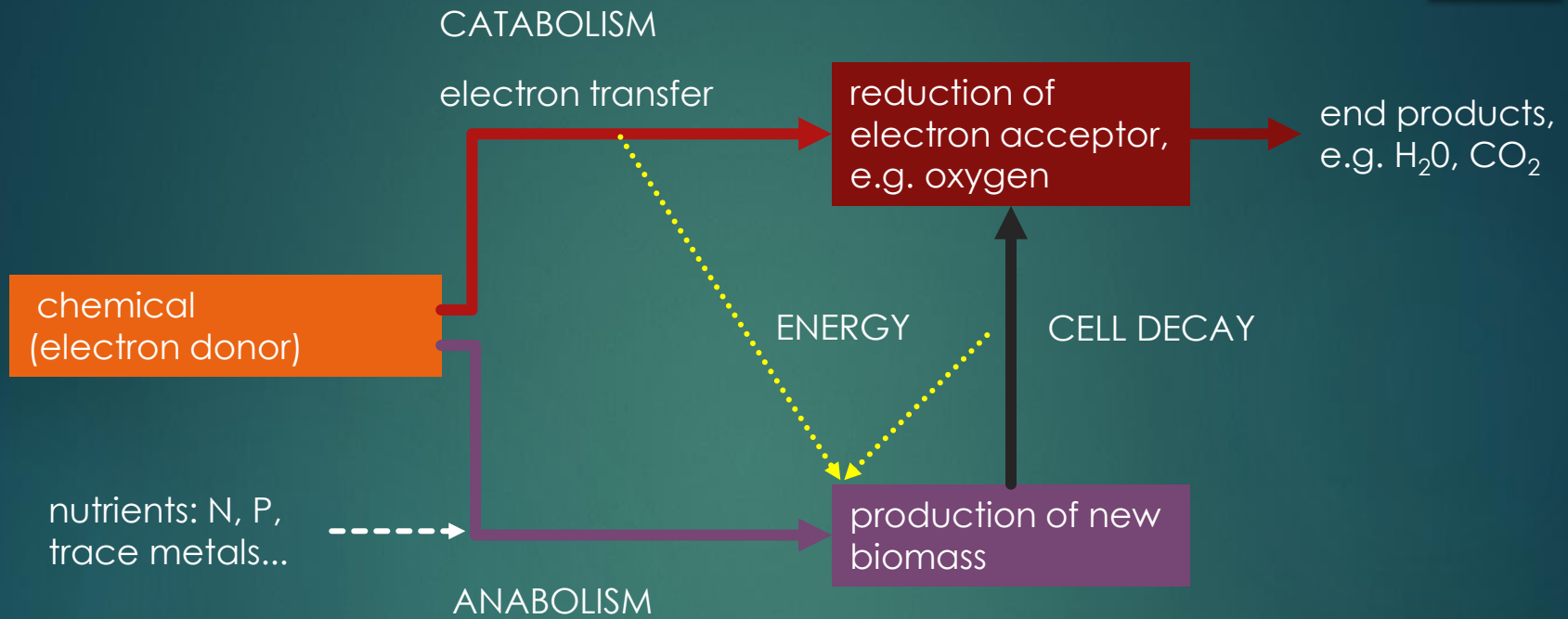

Exhibit 4. Potential chloroethene abiotic degradation pathways

# Natural attenuation: biodegradation, overview

223



# Natural attenuation: biodegradation, metabolisms

224

electron acceptors available in subsurface environment

Metabolism	Electron acceptor	$\Delta G^0$ kJ/mol
aerobic $\text{CH}_3\text{COO}^- + \text{O}_2 \rightarrow 2 \text{HCO}_3^- + \text{H}^+$	oxygen, $\text{O}_2$	-844
denitrification $\text{CH}_3\text{COO}^- + 1,6 \text{NO}_3 + 0,6 \text{H}^+ \rightarrow 2 \text{HCO}_3^- + 0,8 \text{N}_2 + 0,8 \text{H}_2\text{O}$	nitrate, $\text{NO}_3$	-792
iron/manganese reduction $\text{CH}_3\text{COO}^- + 4 \text{Fe}^{3+} + 4 \text{H}_2\text{O} \rightarrow 4 \text{Fe}^{2+} + 5 \text{H}^+ + 2 \text{HCO}_3^-$	ferric ions $\text{Fe}^{+3}$ / manganese ions $\text{Mn}^{+4}$	-352
sulphate reduction $\text{CH}_3\text{COO}^- + \text{SO}_4^{2-} \rightarrow \text{HS}^- + 2 \text{HCO}_3^-$	sulphate, $\text{SO}_4^{2-}$	-48
methanogenesis $\text{CH}_3\text{COO}^- + \text{H}_2\text{O} \rightarrow \text{CH}_4 + \text{HCO}_3^-$	carbon dioxide, carbonate, organic substrate* (fermentation)	-31



## Natural attenuation: biodegradation, electron acceptors utilization sequence

preferential utilization of electron acceptors (due to energy gain – competitive advantage to specific microorganisms):

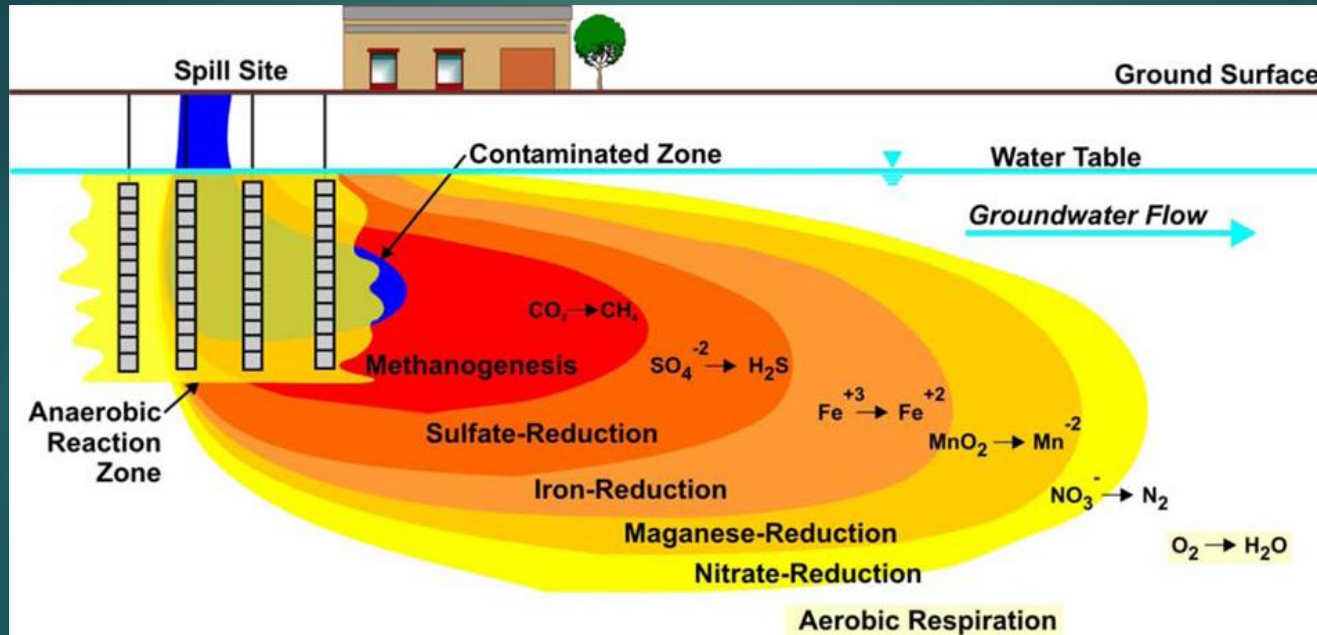

Source: Parsons, 2004

electron acceptor utilization (depletion)/ limitations of recharge (e.g. via groundwater)

electron acceptor availability as limiting factor

# Natural attenuation: biodegradation

Methanogenic conditions:

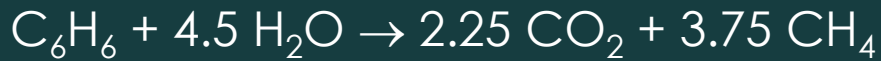

133 kJ/mol; barely feasible, slow

Aerobic conditions:



3,200 kJ/mol; highly feasible, fast

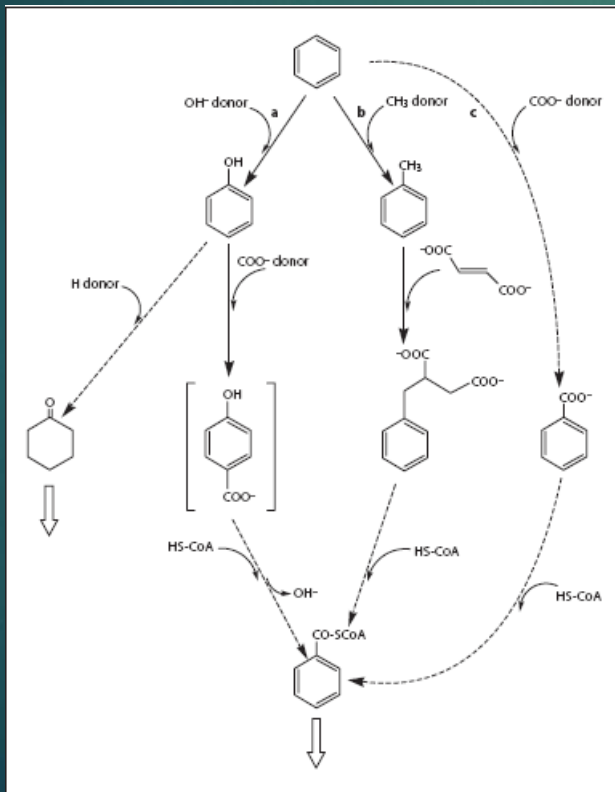

Source: Foght, 2008

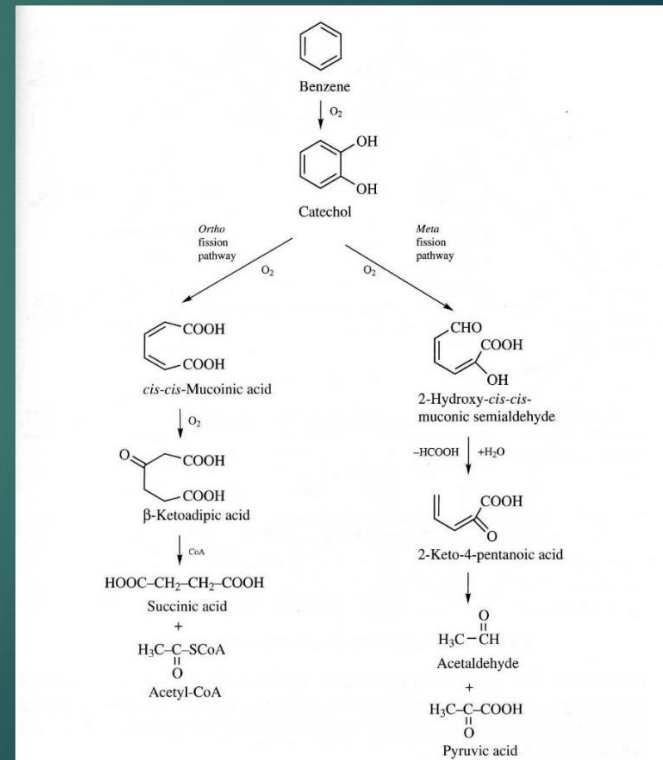

Figure 3.19. Microbial degradation of aromatic compounds by the *ortho* and *meta* fission pathways, as illustrated for benzene.

Source: Alvarez, Illman, 2006

## Natural attenuation: biodegradation, reduction

Highly oxidized organic compounds, like:

- oxygen-rich compounds
- highly halogenated compounds (chlorinated, brominated...)
- nitrated compounds (e.g. trinitrotoluene, TNT)

resist further oxidation, i.e. cannot be used as electron donors (not feasible thermodynamically).

Instead, they can be reduced – used as electron acceptors.

Other substances must serve as electron donors, e.g. hydrogen  $H_2$ , or organic compounds like acetate, methanol, etc.

During reduction, reduced compounds are dechlorinated, nitro group is reduced to amino group, sulphoxides to sulphides, etc. – several simpler intermediates produced.

# Natural attenuation: biodegradation, halorespiration

228

halorespiration – the use of chlorinated compounds as electron acceptors

chlorobenzoates, chlorophenols, PCBs, chlorinated solvents (like PCE)

substrate specificity (electron donors), e.g. only  $H_2$ , acetates:  
low hydrogen threshold

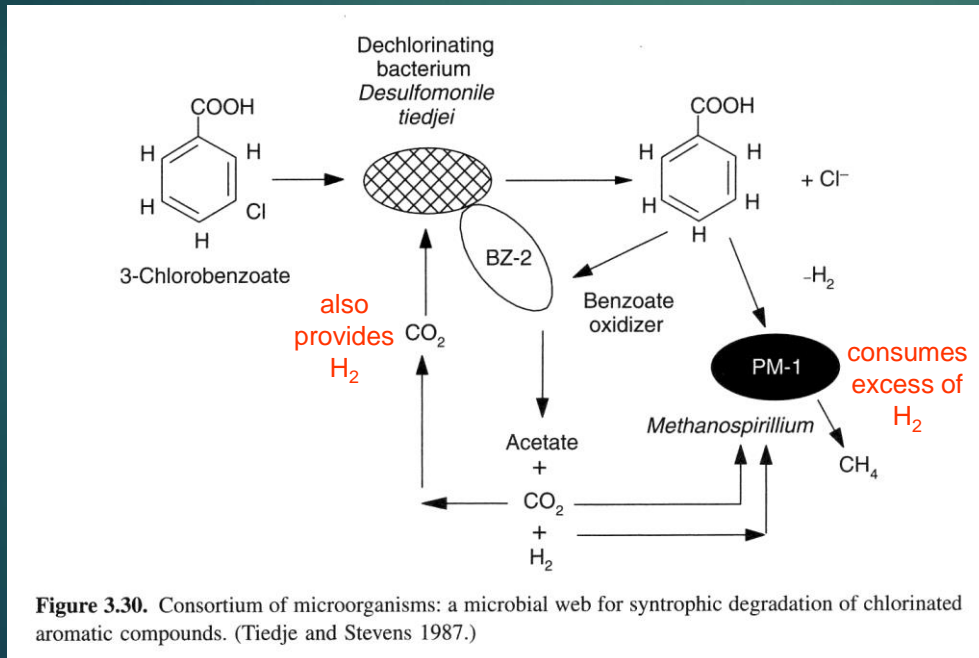

*Desulphomonile tiedjei*

Syntrophism

Source: Suthersan, Payne, 2005

# Natural attenuation: biodegradation, halorespiration

229

*Dehalococcoides ethenogenes* –  
uses only hydrogen as electron donor, acetate as carbon source,

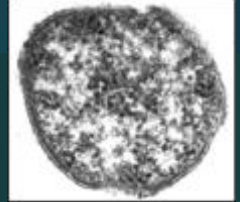

uses chlorinated ethenes as electron acceptors in halorespiration: PCE, TCE, cis-DCE, 1,1-DCE i 1,2-dichloroethane.

Reactions:

hydrogenolysis – replacement of chlorine with hydrogen

dihaloelimination – removal of 2 chlorines with formation of C=C bond

Vinyl chloride and trans-DCE can be dechlorinated only cometabolically, i.e. without energy gain.

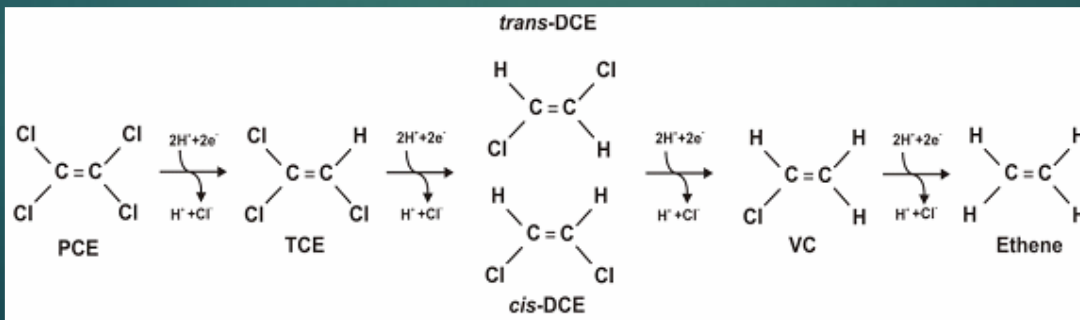

# Natural attenuation: biodegradation, cometabolism

230

Cometabolism: transformation of a chemical compound without using it as a energy source or cell building material mediated by enzyme of wide specificity that routinely acts on another substrate.

Product cannot be used further by cometabolising microorganism; however, in mixed cultures it can be metabolised by other species (commensalism).

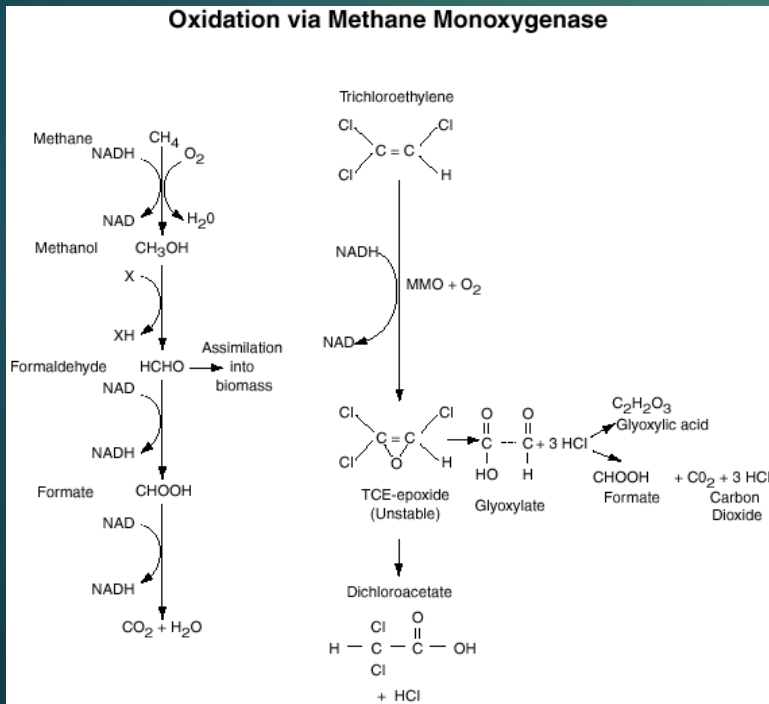

chlorinated pesticides, PCBs,  
alkylbenzene sulphonates,  
nitrobenzene, chlorobenzene, etc.

### Requirements for biodegradation:

- existence of organism(s) with required biodegradation potential
- presence of specific degraders in remediated zone
- accessibility of target pollutants for the microorganisms
- induction of appropriate enzymes (e.g. exceedance of specific threshold)
- availability of appropriate electron acceptors and/or donors
- availability of nutrients
- adequate pH and buffering capacity
- adequate temperature
- absence of toxic or inhibitory substances

first consideration:

- checking available data
- technical, practical, economical aspects
- conceptual site model

demonstration of NA effectiveness:

- investigation to show that NA processes occur on the site
- prove that significant contaminant decreases are obtained
- prove that the contaminant will continue to decrease

development of monitoring program and decision to implement NA:

- checking to see that prerequisites are fulfilled
- evaluating the appropriateness of the solution
- coming to agreement between all parties

implementation and assurance:

- monitoring
- checking if desired results are obtained



## Natural attenuation: evidence for degradation

- contaminant mass loss in the field
- geochemical indicators, “footprints”: depletion of electron acceptors, appearance of products of acceptor reduction, formation of degradation products (metabolites)
- microcosm studies, push-pull tests
- stable isotope analysis (e.g.  $^{13}\text{C}/^{12}\text{C}$ )
- chemical fingerprinting (ratios of different compounds)
- microbial analysis and molecular techniques

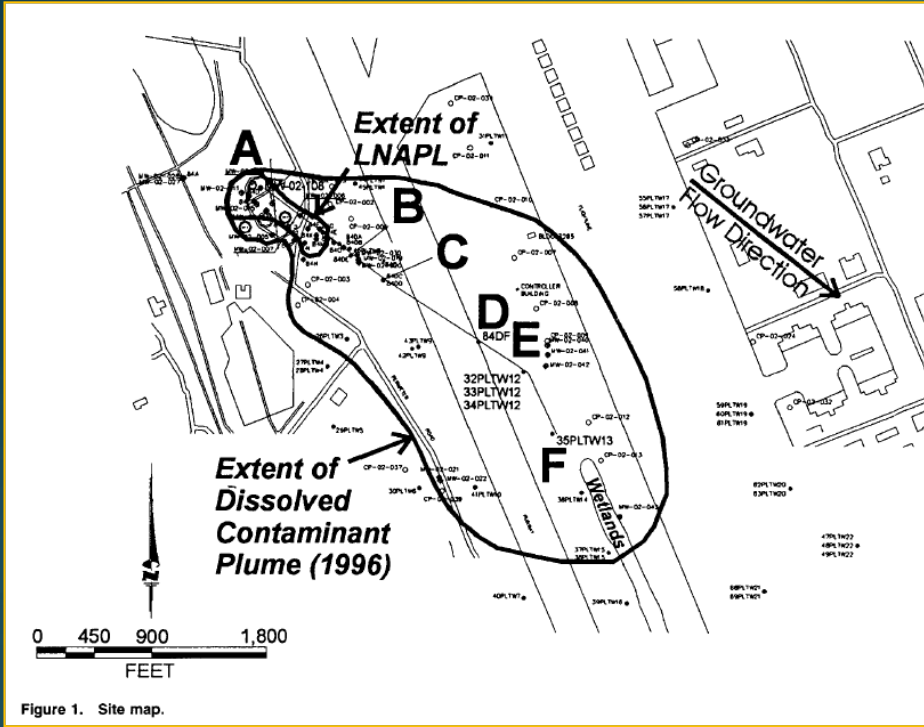

Figure 1. Site map.

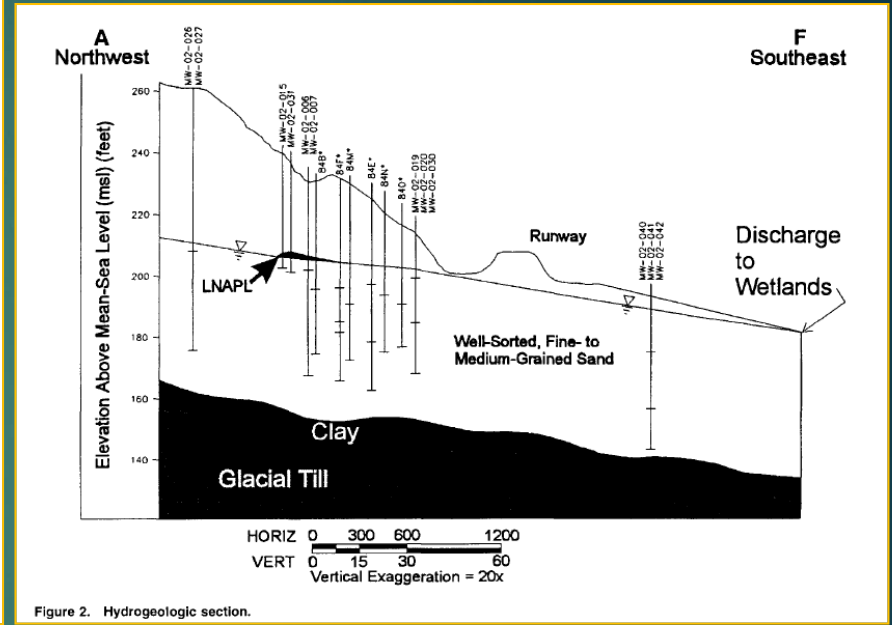

Figure 2. Hydrogeologic section.

Source: Wiedemeier, Wilson, Kampbell, 1996

Plattsburgh Air Force Base, NY; former fire training area (mid-1950 till 1989)

Pollution of shallow groundwater and soil by a mixture of fuel hydrocarbons and chlorinated solvents, i.a. trichloroethene (TCE), cis -1,2-dichloroethene, vinyl chloride, BTEX (up to 17 mg/L)

Table 1. Analytical Data, Plattsburgh Air Force Base

Point	Date	Distance From Source (feet)	TMB (µg/L)	BTEX (µg/L)	TCE (µg/L)	Total DCE <sup>a</sup> (µg/L)	Vinyl Chloride (µg/L)	Methane (µg/L)	Ethene (µg/L)	Chloride (mg/L)	Dissolved Oxygen (mg/L)	Nitrate (mg/L)	Iron(II) (mg/L)	Sulfate (mg/L)	Hydro-gen (nM)	Total Organic Carbon (mg/L)
A	Aug. 95	0	1,757	16,790	25,280	51,412	0	1,420	< 0.001	63	0.1	0.2	4.0	5.5	6.70	80
	May 96		828	6,598	580	12,626	0	1,600	< 0.001	82	0.5	0.0	45.6	1.0	2.00	94
B	Aug. 95	970	491	3,060	2	14,968	897	305	35.00	48	0.5	0.2	15.3	0.0	1.66	30
	May 96		463	4,198	1	9,376	1,520	339	13.00	43	0.1	0.0	16.0	0.0	1.40	31
C	Aug. 95	1,240	488	3,543	3	10,035	1,430	1,010	182.00	46	0.4	0.2	13.8	0.0	NA	21
	May 96		509	3,898	1	10,326	1,050	714	170.00	57	0.2	0.0	19.3	0.0	11.13	24
D	Aug. 95	2,050	NA	NA	NA	NA	NA	NA	NA	NA	NA	NA	NA	NA	NA	NA
	May 96		9	89	0	1,423	524	617	4.00	14	0.2	0.1	2.5	1.5	NA	14
E	Aug. 95	2,560	0	40	24	2,218	8	3,530	< 0.001	20	0.9	0.3	0.7	0.5	NA	8
	May 96		0	40	17	1,051	12	1,800	< 0.001	18	0.1	0.0	0.0	1.0	0.81	8
F	Aug. 95	3,103	0	2	1	226	5	115	< 0.001	3	0.4	10.4	0.0	14.7	0.22	NA
	May 96		0	2	0	177	4	44	< 0.001	3	0.2	9.5	0.1	14.4	0.25	NA

<sup>a</sup> Greater than 99% of DCE is *cis*-1,2-DCE.

NA = Not analyzed.

Point A = MW-02-108, B = MW-02-310, C = 84DD, D = 84DF, E = 34PLTW12, F = 35PLTW13.

## 484 Performance Assessment and Demonstration of Bioremediation

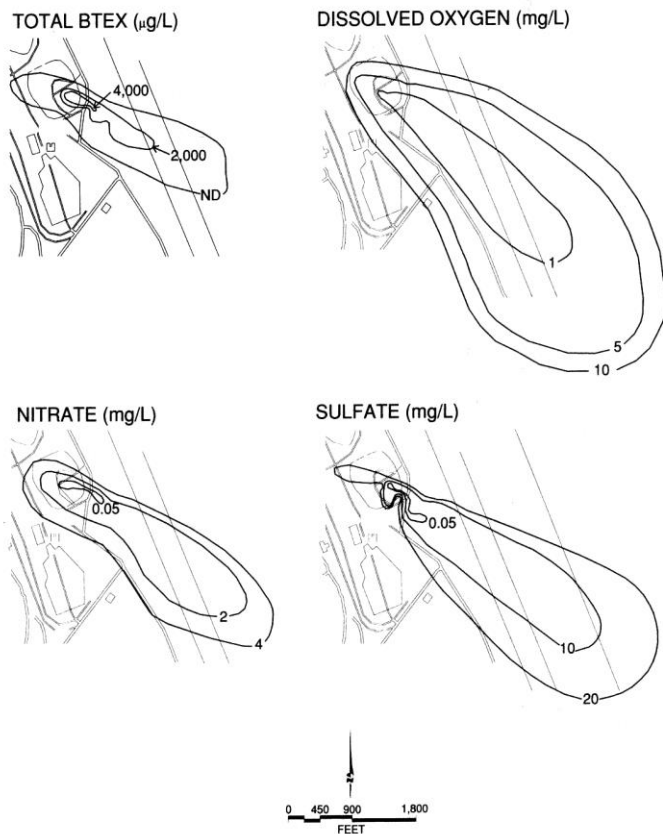

**Figure 9.8.** Contour plots of BTEX and electron acceptors, measured in 1995, from Plattsburgh Air Force Base, New York. (Adapted from Wiedemeier et al. 1999.)

## Lines of Evidence of Intrinsic Bioremediation 485

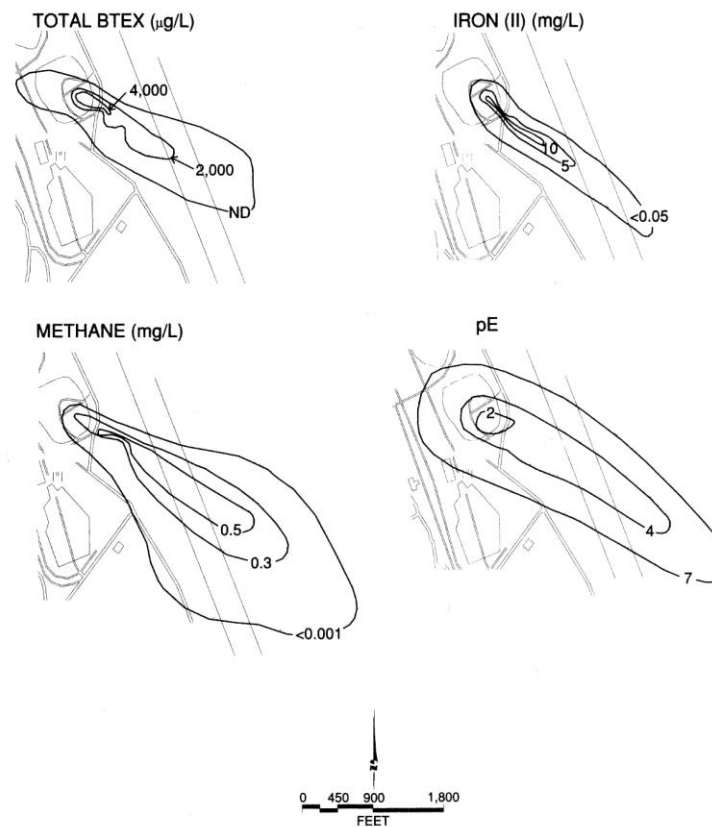

**Figure 9.9** Contour plots of BTEX and metabolic by-products, measured in 1995, from Plattsburgh Air Force Base, New York. (Adapted from Wiedemeier et al. 1999.)

Steady state

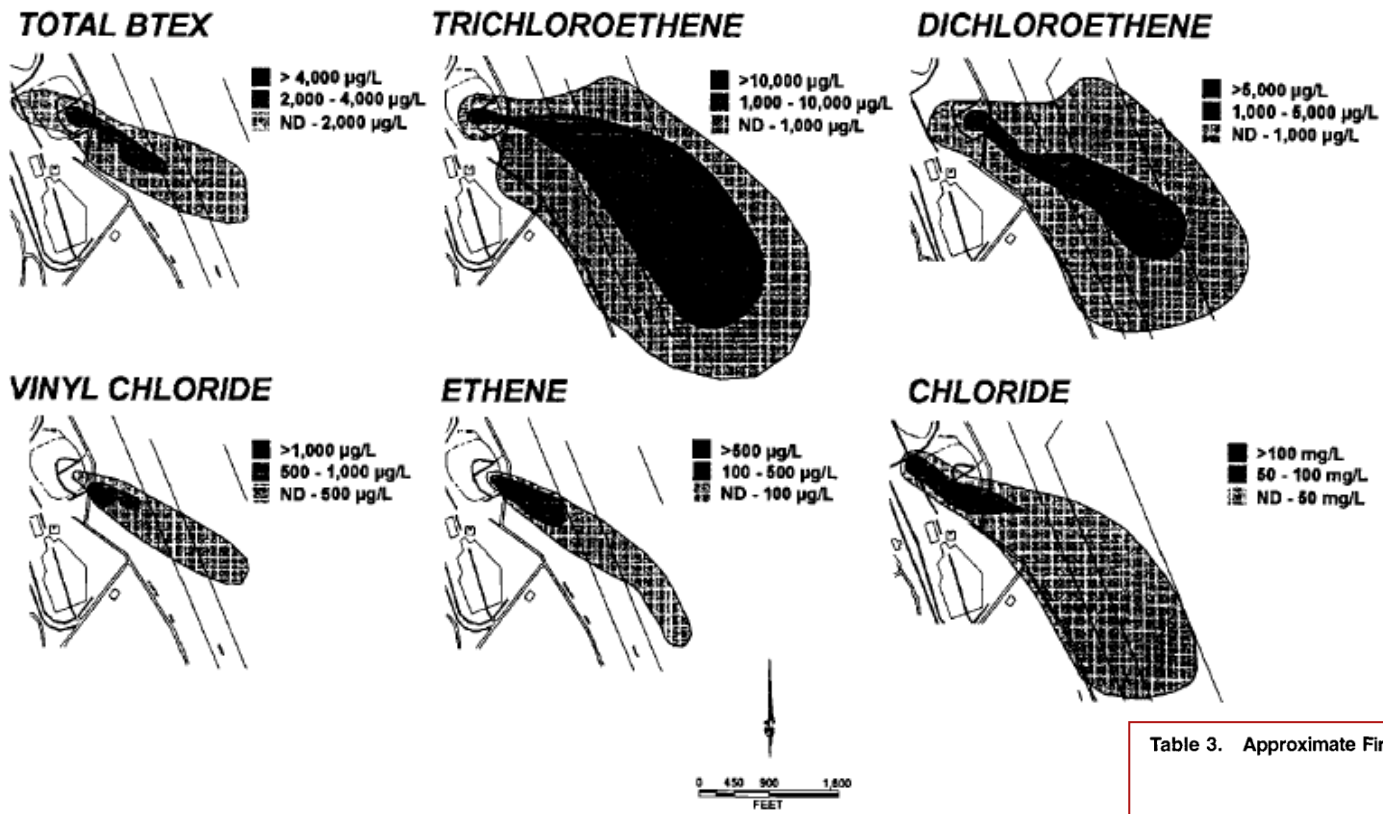

Figure 3. Chlorinated solvents and byproducts (1995).

Source: Wiedemeier, Wilson, Kampbell, 1996

Biodegradation rates calculated by the method relative to the conservative tracer: TMB trimethylbenzene

Table 3. Approximate First-Order Biodegradation Rate Constants

Compound	Correction Method	A - B 0 to 970 feet (1/year)	B - C 970 to 1,240 feet (1/year)	C - E 1,240 to 2,560 feet (1/year)
TCE	Chloride	1.27	0.23	-0.30
	TMB	1.20	0.52	NA
	Average	1.24	0.38	-0.30
DCE	Chloride	0.06	0.60	0.07
	TMB	0.00	0.90	NA
	Average	0.03	0.75	0.07
Vinyl chloride	Chloride	0.00	0.14	0.47
	TMB	0.00	0.43	NA
	Average	0.00	0.29	0.47
BTEX	Chloride	0.13	0.30	0.39
	TMB	0.06	0.60	NA
	Average	0.10	0.45	0.39

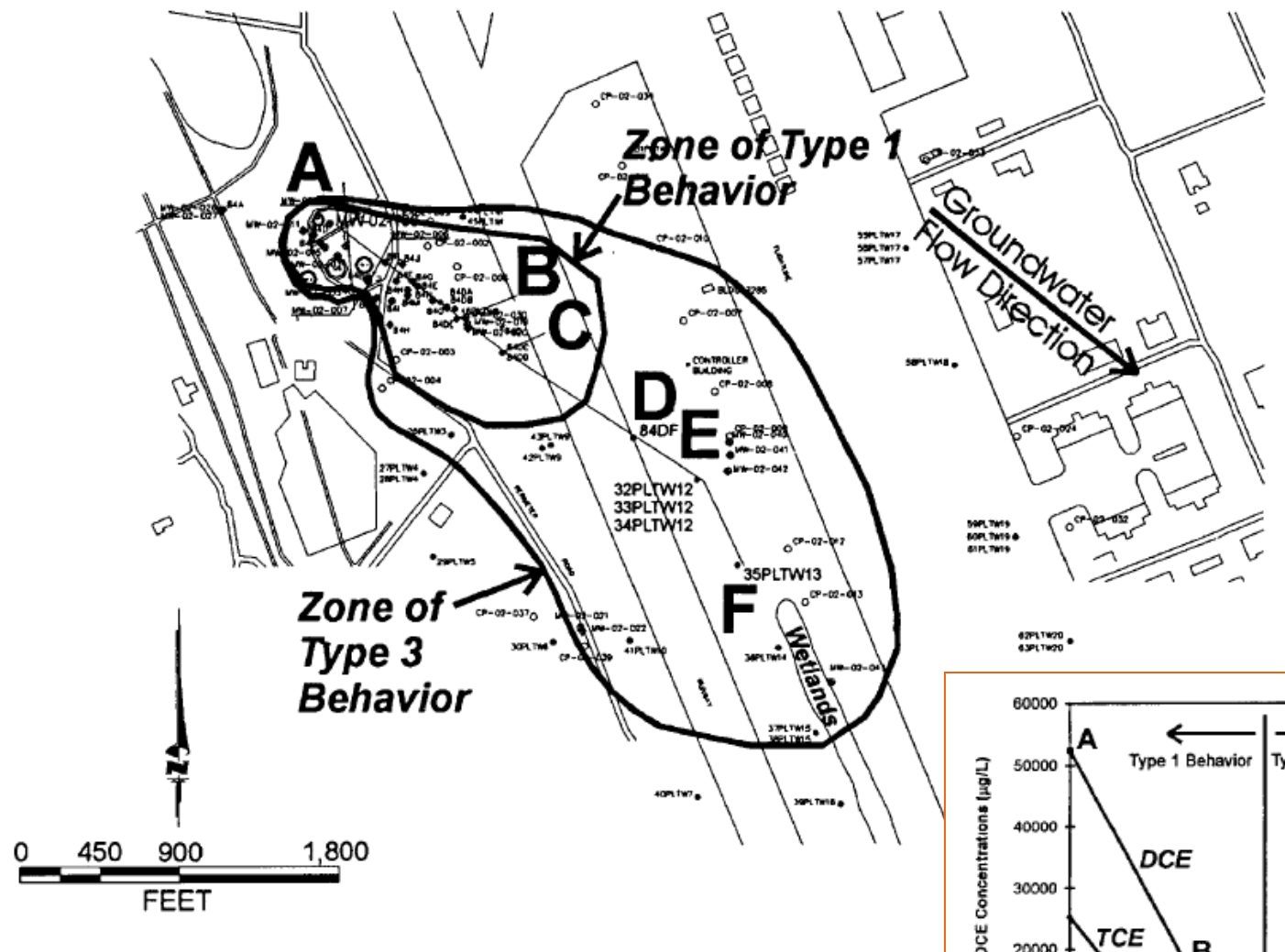

Figure 6. Zonation of CAH plume.

Source: Wiedemeier, Wilson, Kampbell, 1996

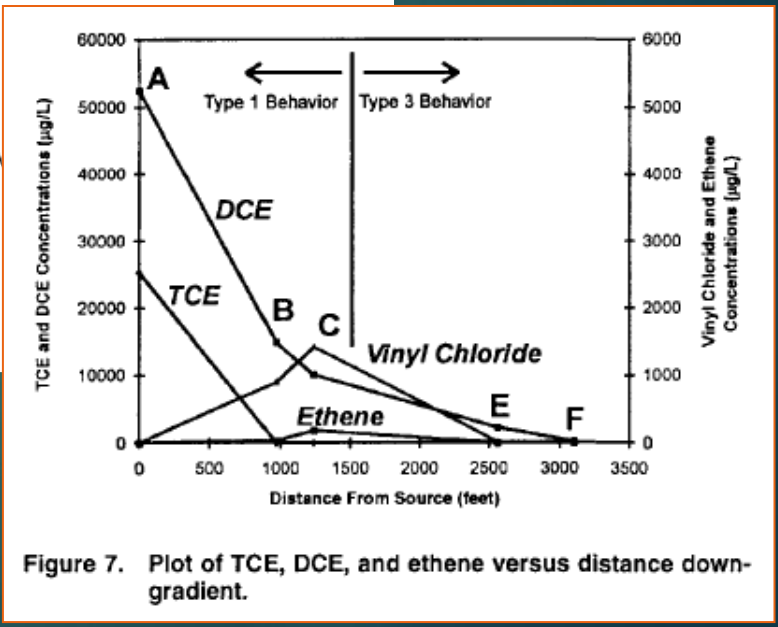

Figure 7. Plot of TCE, DCE, and ethene versus distance down-gradient.

## Bioremediation

The use of microorganisms to remove/degrade/detoxify pollutants

**BIOSTIMULATION** – use of indigenous organisms; stimulation by creating appropriate conditions (manipulation of pH, redox conditions, addition of nutrients, electron donors or acceptors, co-substrates for cometabolism, etc.)

**BIOAUGMENTATION** – inoculation with specialized microorganisms; they can be indigenous, selected and multiplied in laboratory conditions (recalcitrant pollution, indigenous activity inadequate)

**IN-SITU** – where it is possible or necessary

**EX-SITU** (on-site, off-site) – e.g. contaminations that are hard to biodegrade, high concentrations of pollutants

## Injection of compressed air into saturation zone – air sparging (biosparging)

- stripping (gas desorption) of volatile pollutants: from the aqueous phase, evaporation of volatile pollutants adsorbed and in thin film form; (realistic for components of gasoline, BTEX, TCE, PCE; compounds with Henry constant  $> 10^{-5} \text{ atm}\cdot\text{m}^3 / \text{mol}$ )
- stimulation of biological processes: aerobic biodegradation (e.g. components of diesel oil – partially)

NAPL free phase must be removed before sparging!

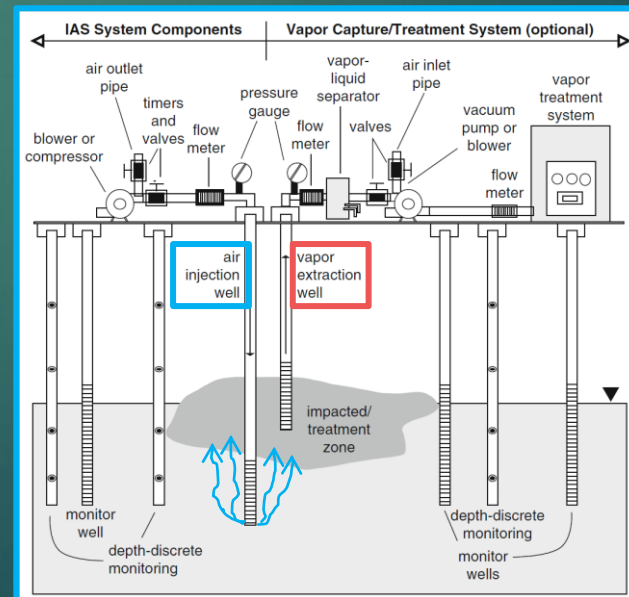



## Bioremediation in situ: bioventing

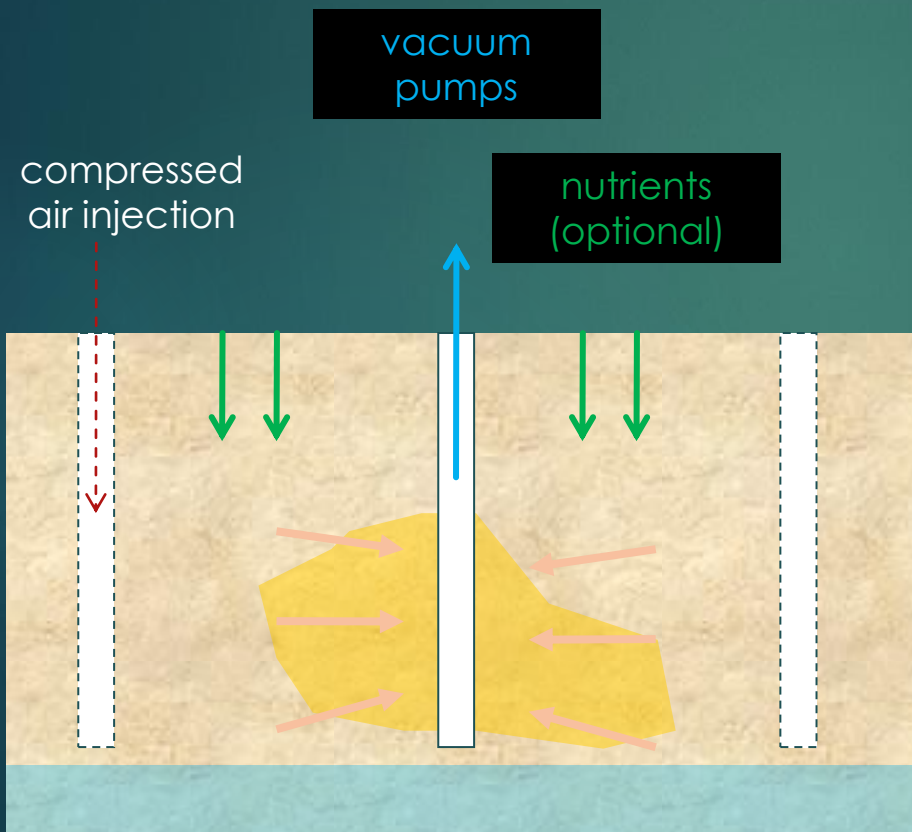

Induction of air flow in unsaturated zone, e.g. by use of vacuum pumps:

Nutrient addition to prevent desiccation:

- enhancement of indigenous microorganisms activity (aerobic degradation of pollutants)

lower air flow rates comparing to soil vapour extraction.

# Bioremediation in situ: water recirculation or liquid delivery – aerobic

242

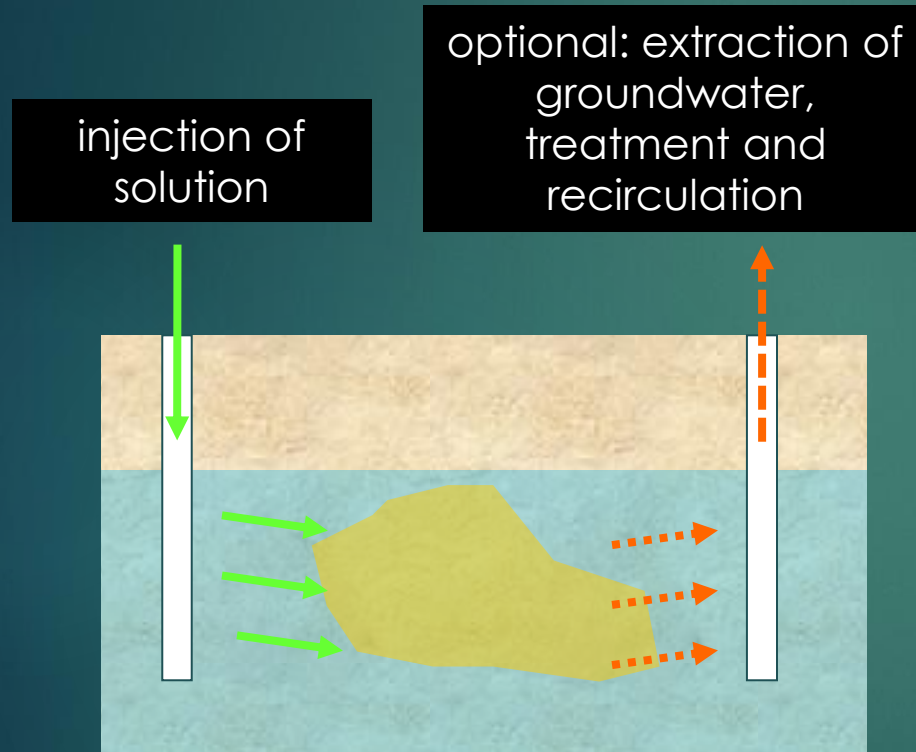

Stimulation of aerobic metabolism (e.g. contamination by petroleum products), injections of:

- oxygenated water
- hydrogen peroxide solution

used as component of oxygen releasing compound (ORC) concrete blocks (slow release of oxygen):

- calcium and magnesium peroxide
- calcium percarbonate
- urea-hydrogen peroxide.

Optional: nutrient addition

# Bioremediation in situ: water recirculation or liquid delivery – anaerobic

Stimulation of anaerobic metabolism (e.g. chlorinated solvents), injections of easily degradable substrates:

- methanol
- lactates
- glucose
- molasses
- starch syrup
- whey

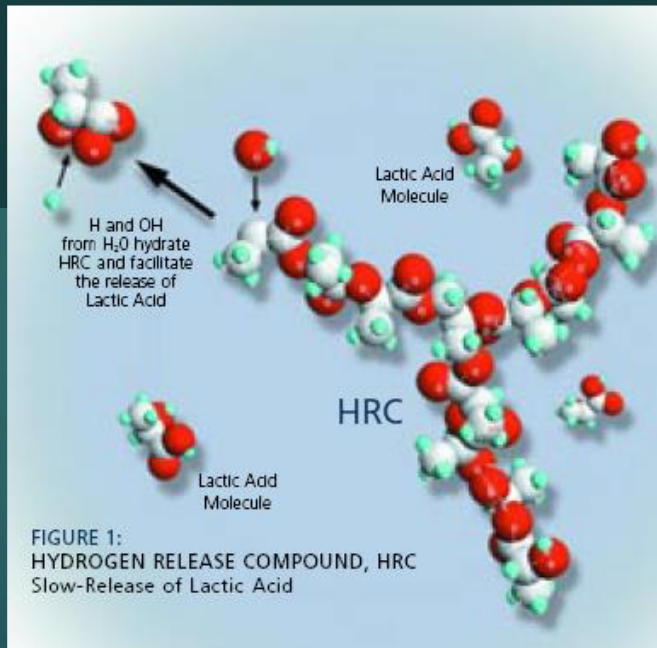
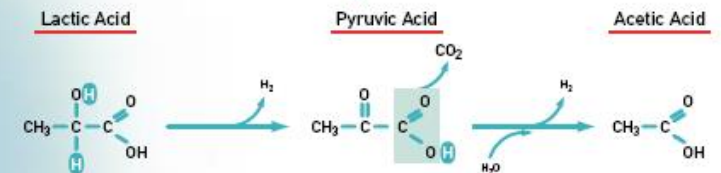
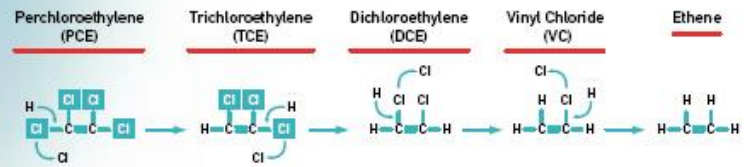

FIGURE 2:  
BREAKDOWN OF LACTIC ACID AND RELEASE OF HYDROGEN

BREAKDOWN OF LACTIC ACID FROM HRC YIELDS HYDROGEN (H<sub>2</sub>)



INCREASED HYDROGEN ENHANCES REDUCTIVE DECHLORINATION



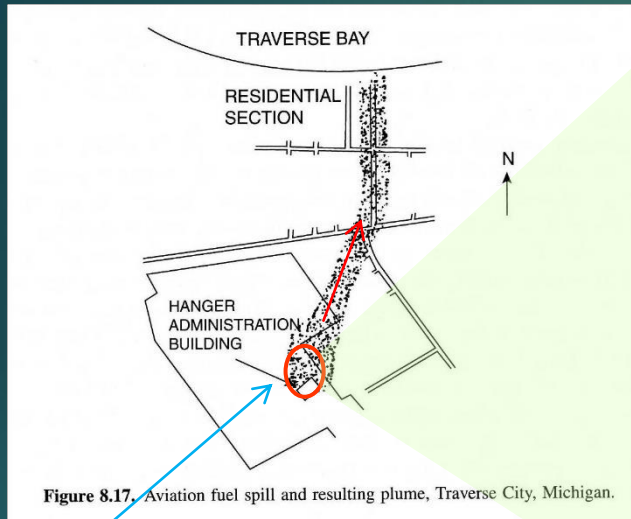

Source: Alvarez, Illman, 2006

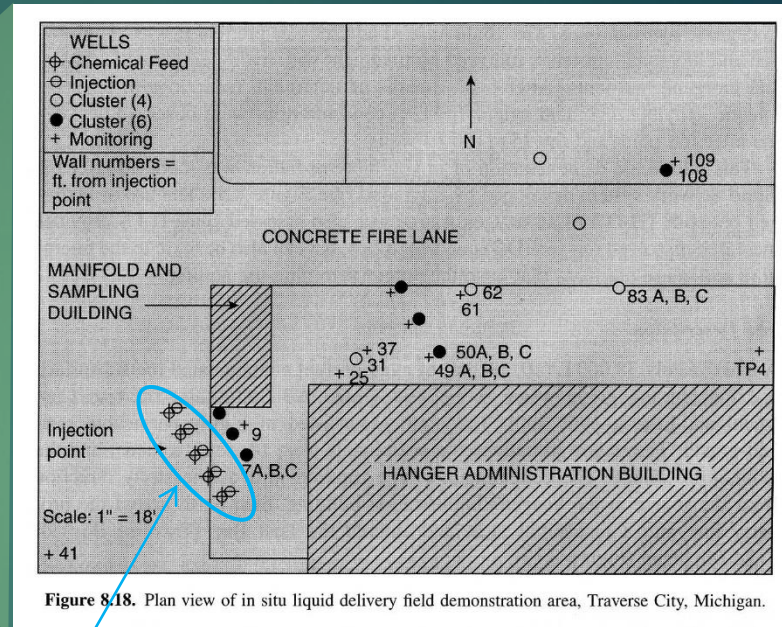

38 m<sup>3</sup> spill of aviation fuel in 1969.

Pollution in groundwater: benzene, toluene, xylene.

Aquifer: highly permeable sand and gravel.

Injection of nutrient solution: 75 mg/l P, 100 mg/l N-NH<sub>4</sub>,

Injection of oxygenated water (40 mg/l O<sub>2</sub>).  
Depth 4.3 and 5.9 m, flow 3 l/min.

after three months – change to 50 mg/l H<sub>2</sub>O<sub>2</sub>,  
gradual increase up to 500 mg/l after 11 weeks,  
maintained for 9 weeks (total 230 days).

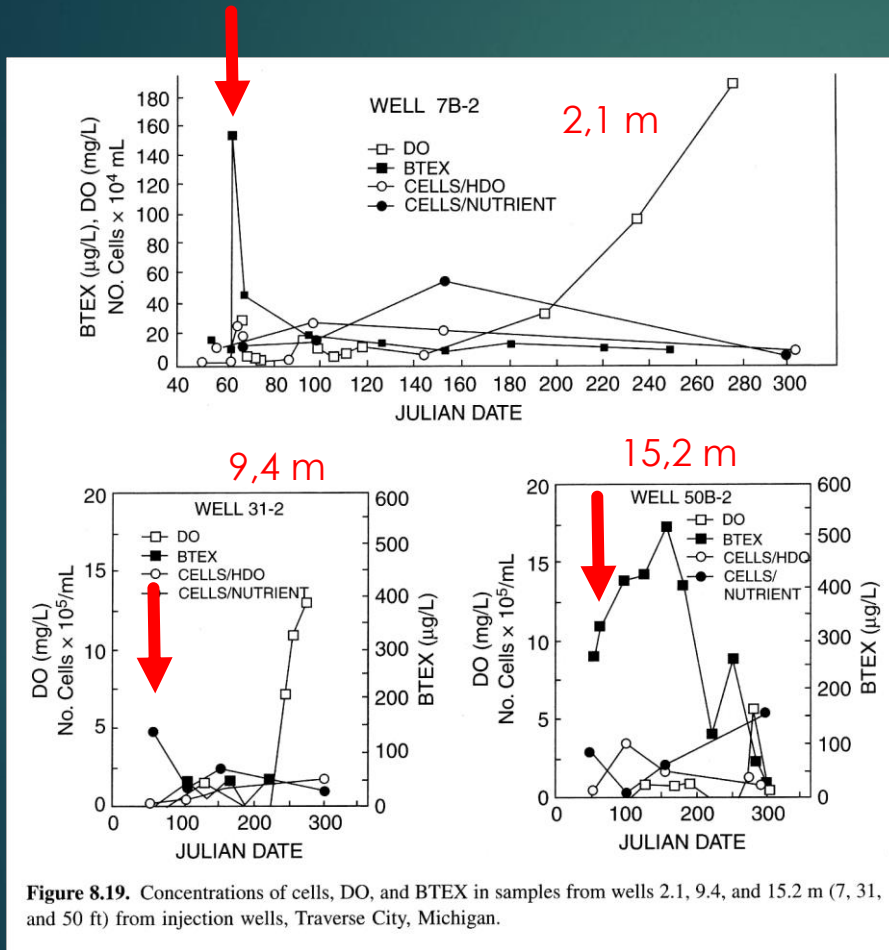

**Figure 8.19.** Concentrations of cells, DO, and BTEX in samples from wells 2.1, 9.4, and 15.2 m (7, 31, and 50 ft) from injection wells, Traverse City, Michigan.

Source: Alvarez, Illman, 2006

Julian date: day from the start of the project = injection performed from day 60.

Results from monitoring wells at distances 7, 31 and 50 feet (2.1, 9.4 and 15.2 m) from the injection point; depth from 4.3 to 6.9 m below surface.

DO – dissolved oxygen

BTEX

cell – the number of bacteria determined on agar with hydrocarbons

cel/nutrient – as above, on agar with nutrients

Decrease of BTEX and increase of oxygen:

2.1 m – after 150 days

9.4 m – after 250 days

15.4 m – after 300 days.

# Bioremediation in situ: tetrachloroethylene, anaerobic

246

## Remediation in Fine-grained Material Site Layout

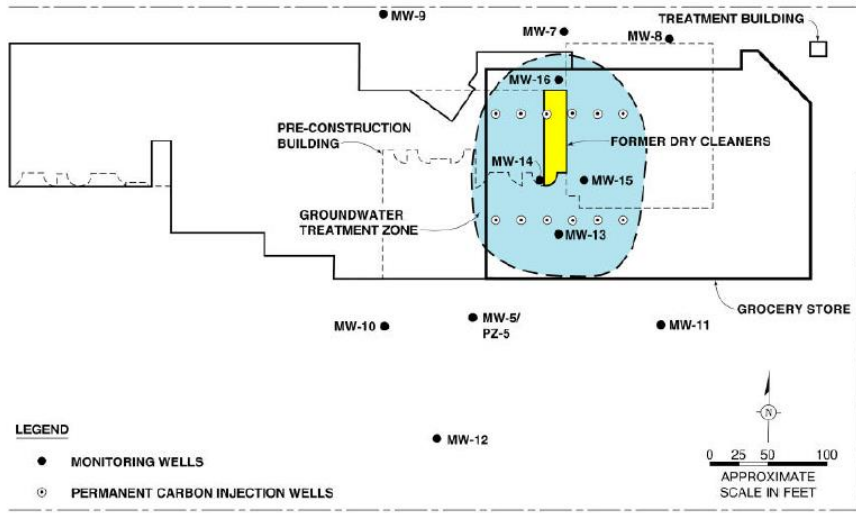

Source: Barry Molnaa, ARCADIS

## Geologic Cross Section

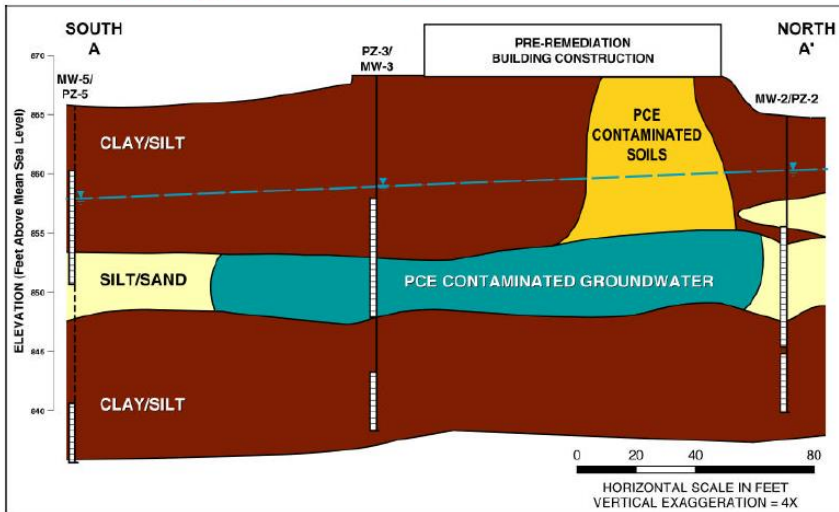

Polluted before 1998, dry cleaning;

Area intended for revitalization  
(shopping centre);

PCE concentration in groundwater  
1500–4000  $\mu\text{g/l}$ ;

First step: removal of polluted soil and  
part of groundwater.

## Initial Carbon Injection



## Initial Carbon Injection

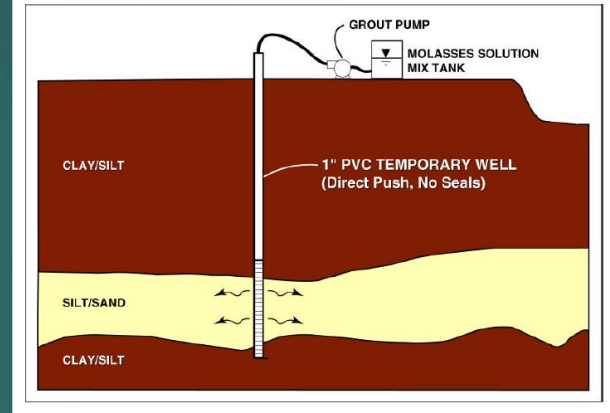

## Fixed Injection Well System

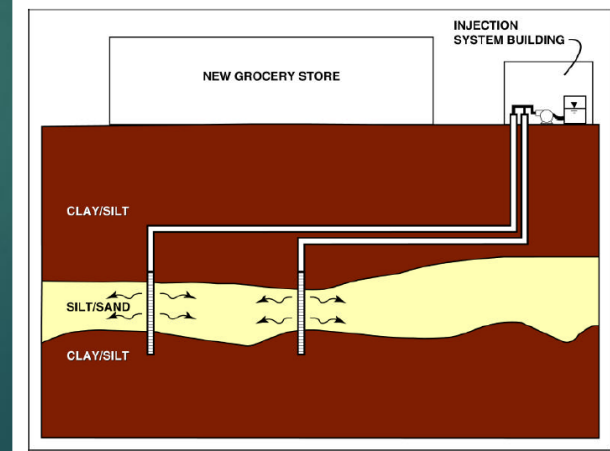

Second step: stimulation of anaerobic biodegradation.

Initially: 182 injection points every 3 m, injection of 4% molasses solution: 12 m<sup>3</sup> by 11d.

Permanent system, after building the area.  
12 injection wells – 5 cm diameter.

4 injections over 6 months: 11.3 m<sup>3</sup> 4% molasses.

## Groundwater Remediation Results Monitoring Well MW-13

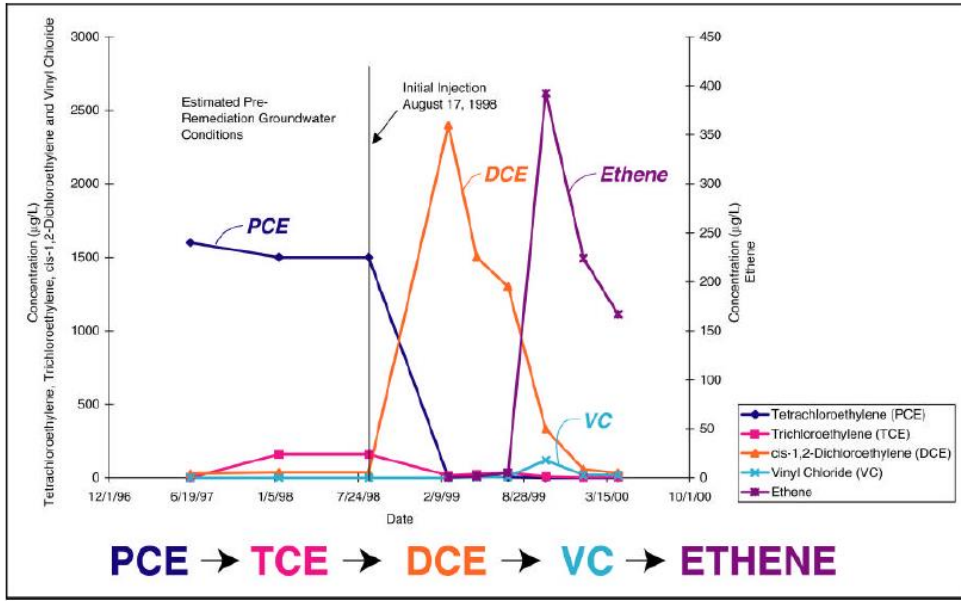

Source: Barry Molnaa, ARCADIS

## PCE Transformation Over Time – Monitoring Well MW-13

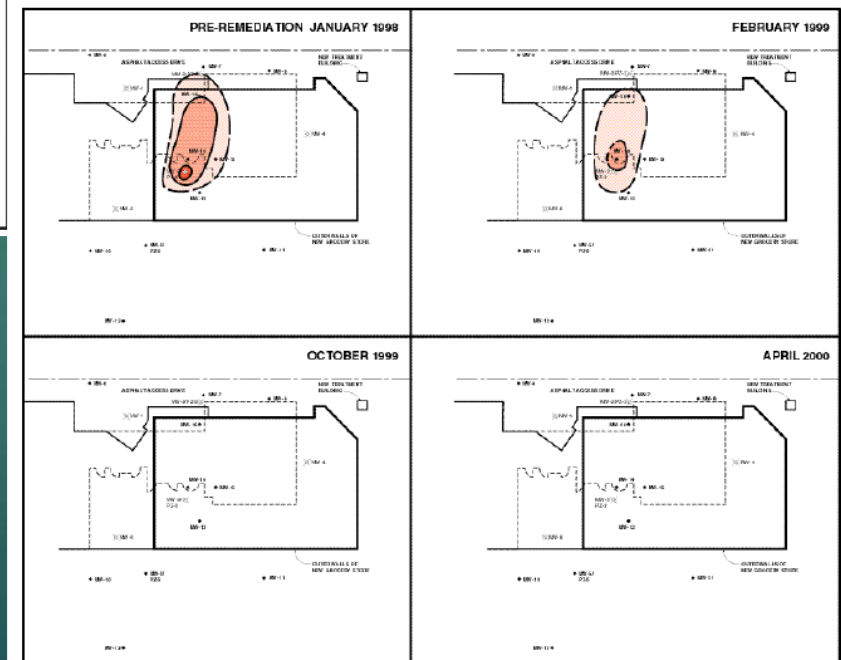
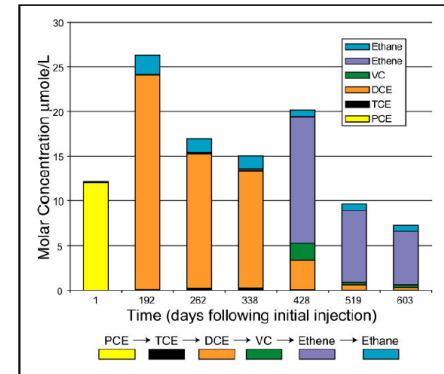



# Bioremediation in situ: hexachlorocyclohexane, anaerobic-aerobic



Landfill of "inactive" hexachlorocyclohexane (HCH) isomers (byproducts from pesticide lindane production).

About 140,000 m<sup>3</sup> of contaminated soil and groundwater. Concentration of HCH up to 2.4 mg/dm<sup>3</sup> (mainly  $\beta$  and  $\alpha$  isomers).

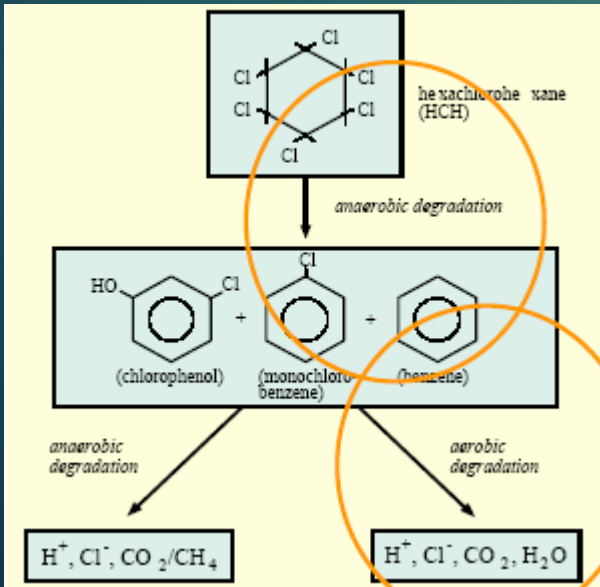

Laboratory tests confirmed the ability of native microorganisms to anaerobically transform HCH into dichlorophenol, chlorobenzene and benzene (Langenhoff et al., 2002).

Stimulation necessary.

Source: www.unep.org

# Bioremediation in situ: hexachlorocyclohexane, anaerobic-aerobic

250

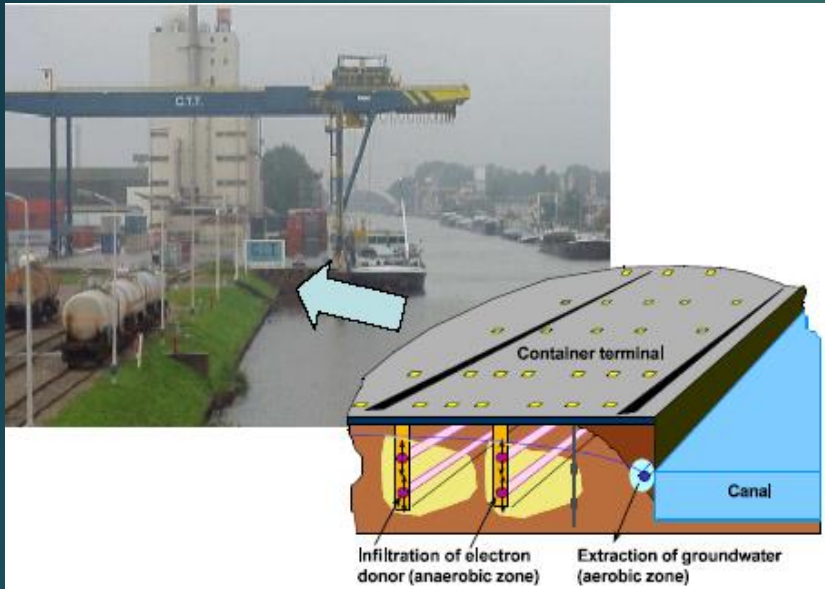

2001: two drain lines periodically delivering methanol solution as electron donor (stimulation of anaerobic degradation).

Waters extracted on embankment and directed to a biological treatment plant (aerobic degradation of metabolites).

1.5 years: lowering of HCH concentration from approx. 10 to below  $1 \mu\text{g}/\text{dm}^3$  in groundwater.



# Bioremediation ex-situ: landfarming

251

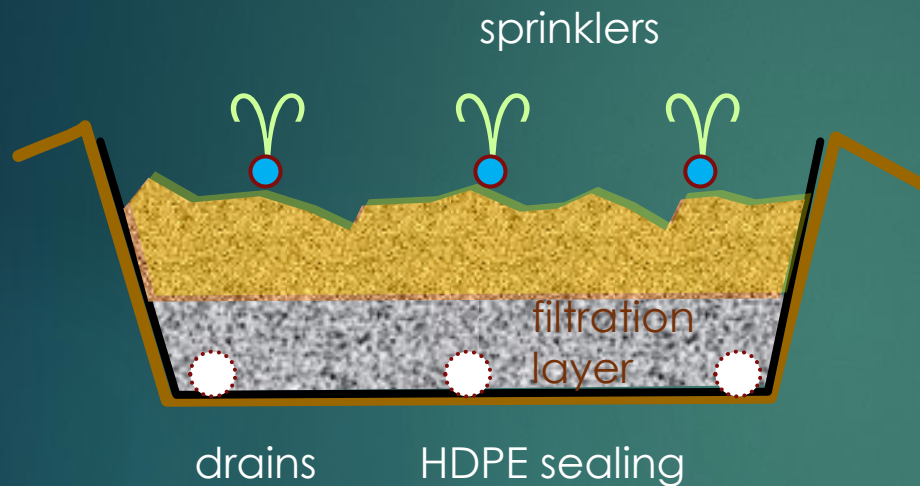

Landfarming:

soil layer 30–45 cm:

- aeration by tilling every few days
- sprinkling: maintaining humidity, delivery of nutrients, possible bioaugmentation

Pollutants: petroleum products, PAHs (low concentration).

The lowest costs, long time (up to several years).



Source: gastechology.org

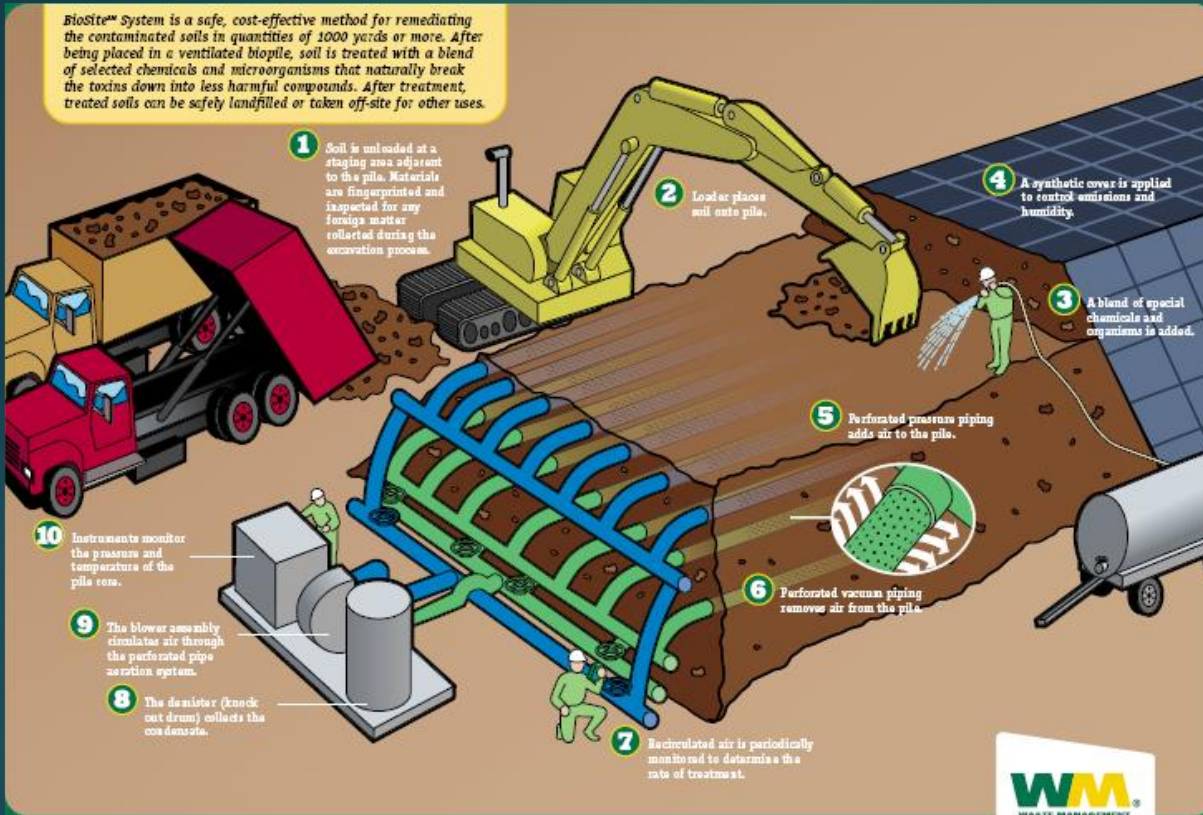

- aeration (over- or underpressure).
- watering – 40–60% WHC (option – water recirculation)
- bioaugmentation (option)

Contaminants: PAHs;

Height 2–3 m max.,  
operating time up to  
several months.

Possible combination with composting – mixing with bulking agents (plant waste, straw, chips, etc).

- raises the temperature, even 60°C or more
- rich, versatile microflora

# Bioremediation ex-situ: slurry reactors

253

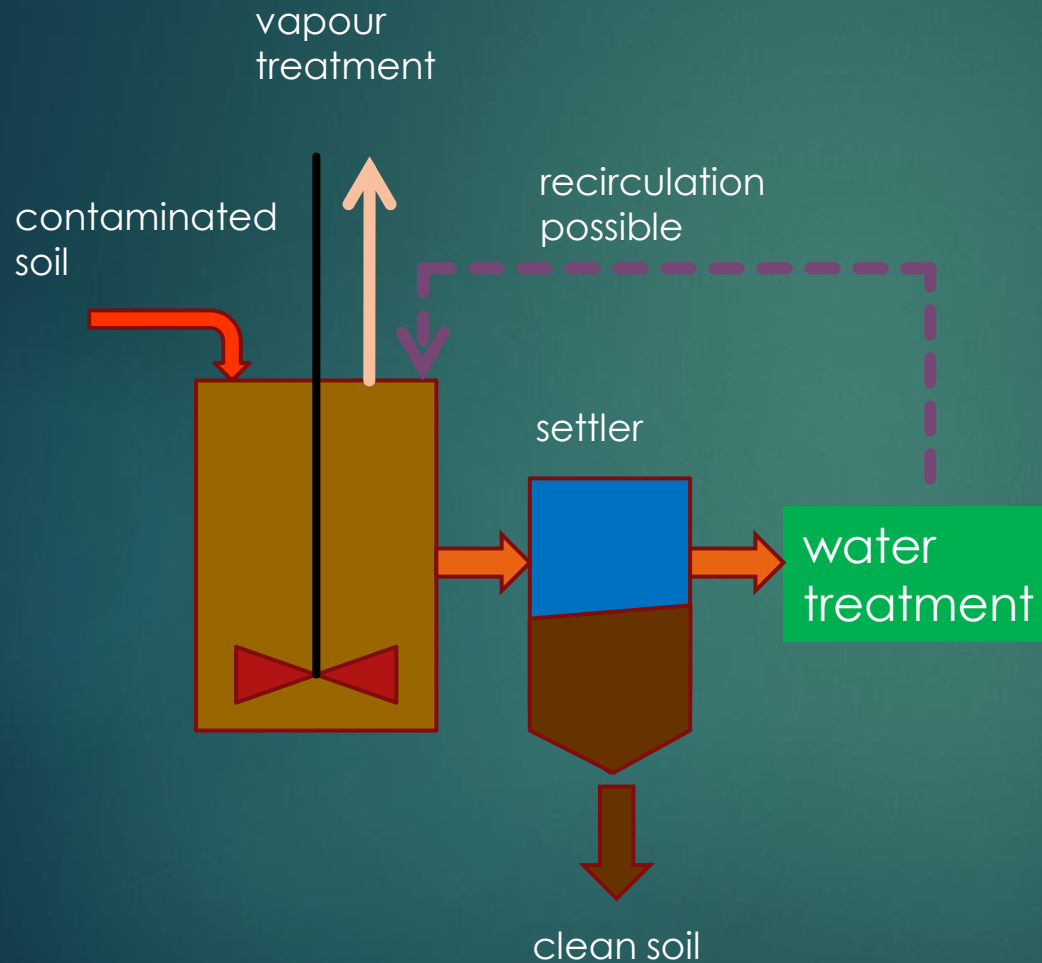

A suspension of 10–40% soil in water, after sieving acceleration of the process: better contact and mass transport; higher reaction rates; possibility of effective application of various conditions (temperature, pH, addition of electron acceptors and donors, surfactants, inoculation)

Most expensive batch mode or continuous (rare)

60–1,000 m<sup>3</sup>, can be made as ground quarters

PAHs, some pesticides, PCBs, explosives

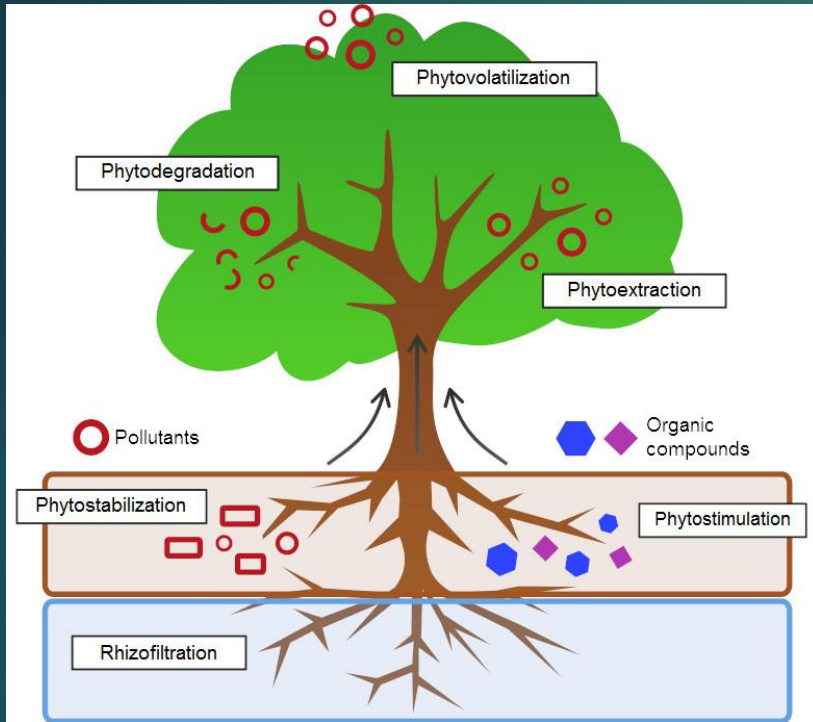

Source: <https://commons.wikimedia.org/w/index.php?curid=53861918>

## Mechanisms:

- phytodegradation – transformation of pollutants in plants
- phytoextraction – accumulation of pollutants in plants
- phytostabilization – immobilization of pollutants in soil
- phytovolatilization – evaporation of pollutants
- rhizofiltration – adsorption of soluble pollutants in the rhizosphere
- phytostimulation – degradation of pollutants in the rhizosphere

Application: mainly heavy metals, but also PAHs, petroleum products, PCBs...

Necessary selection of plants in terms of:

- effectiveness of remediation
- resistance to pollution

## Phytoremediation

**Table 1.** Heavy metal accumulation in some hyper-accumulating plants. (Adapted from Cunningham and Ow 1996)

Element	Species	Level (mg kg <sup>-1</sup> dry wt.)
Mn	<i>Macadamia neutrophylla</i>	51,800
Zn	<i>Thlaspi caerulescens</i>	51,600
Ni	<i>Psychotria douarrei</i>	47,500
Cu	<i>Ipomoea alpina</i>	12,300
Co	<i>Haumaniastrum robertii</i>	10,200
Pb	<i>Thlaspi rotundifolium</i>	8,200
Cd	<i>Thlaspi caerulescens</i>	1,800



Plants of the cucurbits family (*Cucurbitaceae*): pumpkin, squash, zucchini – the ability to significantly phytoaccumulate chlorinated pesticides like DDT and its metabolites, DDE and DDD in overground parts of plants.

Enhancement by addition of phytoextraction aids, e.g. citric acid.

Low efficiency: extraction up to several %.

Field tests – slow process; time needed for remediation up to several hundred years.





Part 7

**Project:**

**Prediction of risk by  
contaminant plume spread**

# Sequence: source-migration-receptor

258

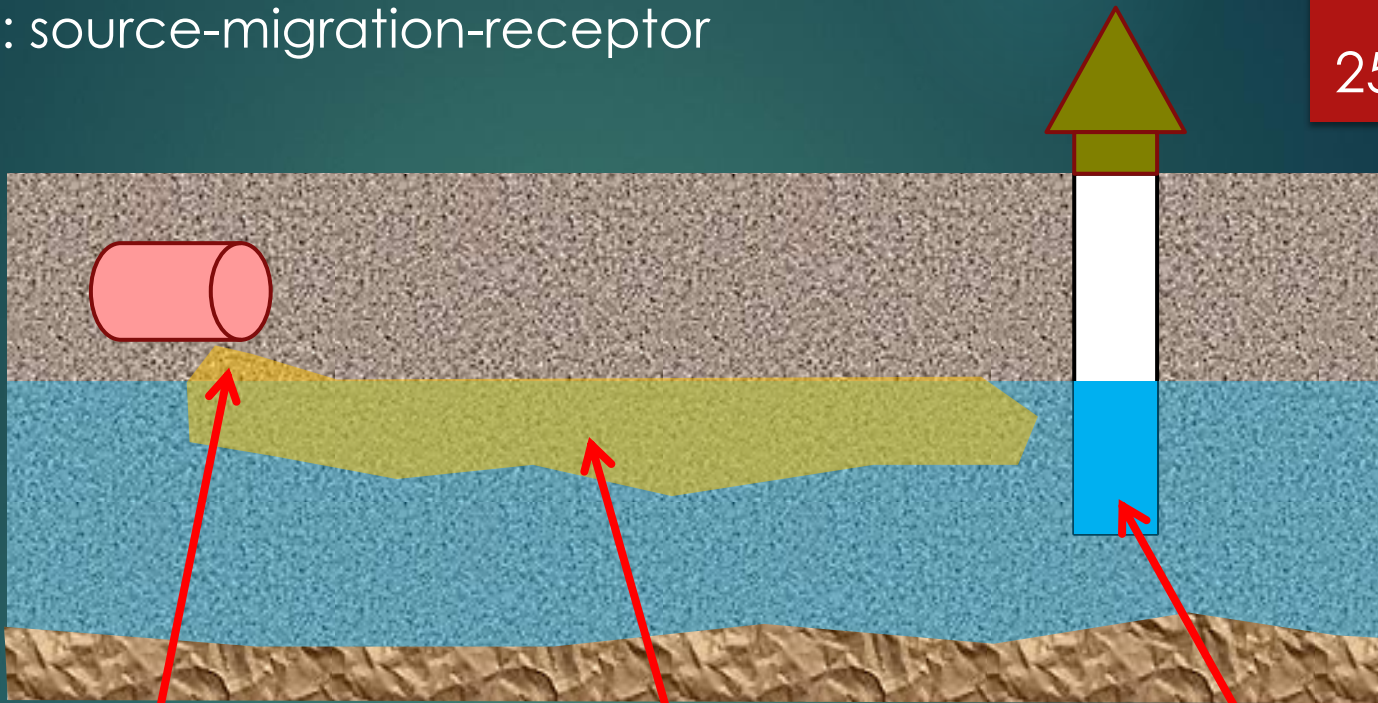

source:  
type of pollution,  
quantity, concentration

transport:  
dispersion  
degradation

receptor:  
effect

1. Soil quality standards
2. Risk assessment

# Soluble contamination – transport mechanisms

259

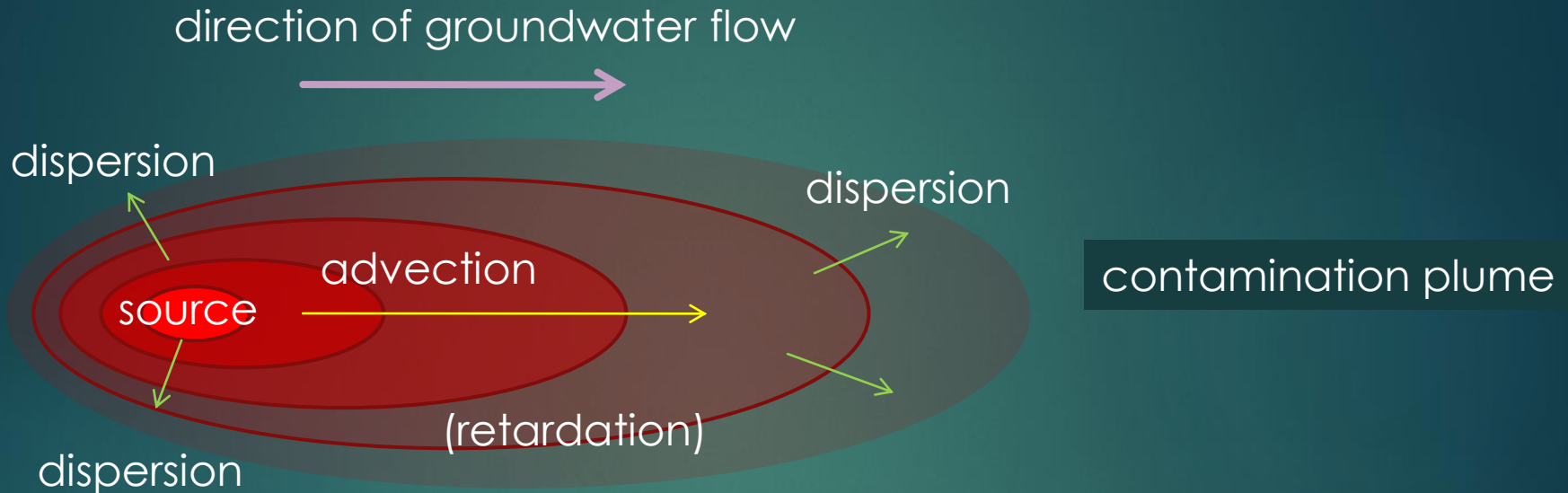

**Advection** – transport by groundwater flow

Darcy's Law:

$$v = - (K_h / \phi_e) (\Delta h / \Delta x)$$

$K_h$  = hydraulic conductivity, m/s

$\phi_e$  = effective porosity

$(\Delta h / \Delta x)$  = hydraulic gradient

Retardation is a delay of pollutants migration resulting from the sorption and desorption processes. Retardation depends on 1) susceptibility of contamination to sorption (hydrophobicity) 2) sorptive properties of soil. It can change depending on the concentration of pollutants.

Retardation coefficient  $R_f$ :  $R_f = v / v_c$

where  $v$  is the groundwater linear velocity, and  $v_c$  is the velocity of contaminant migration

$$R_f = 1 + K_d \rho_b / \phi$$

$K_d$  = distribution coefficient =  $K_{OC} \times f_{OC}$

where  $K_{OC}$  is the distribution coefficient between organic carbon (SOM) and water,  $f_{OC}$  = organic carbon fraction in soil,  $\rho_b$  = soil bulk density,  $\phi$  = total porosity

$$v_c = - (K_h / R_f \times \phi_e) (\Delta h / \Delta x)$$

Dispersion coefficient:

$D = a \times v_c$  where  $v$  is the groundwater linear velocity or velocity of pollutant migration, and  $a$  is the dispersivity (property of a given aquifer)

$D$  is a combination of effects of mechanical dispersion and diffusion:

$$D = D' + D_B$$

Usually longitudinal dispersion (along direction of flow) is 10–20 times greater than transversal dispersion (perpendicular to flow).

Domination of dispersion or diffusion depends on Peclet number:

$$P = v \times d_0 / D_B$$

where  $d_0$  is diameter of soil particles.

## Degradation (dissipation) of pollutant

Combination of effects of biotic and abiotic degradation, volatilization, etc.

$$dC/dt = \lambda \times C \text{ (first order kinetics)}$$

where  $\lambda$  is the degradation rate coefficient

$$C = C_0 \exp (\lambda \times t)$$

half-life time = (C = 0.5 C<sub>0</sub>)

$$t_{1/2} = \ln (2) / \lambda \quad \lambda = \ln (2) / t_{1/2}$$

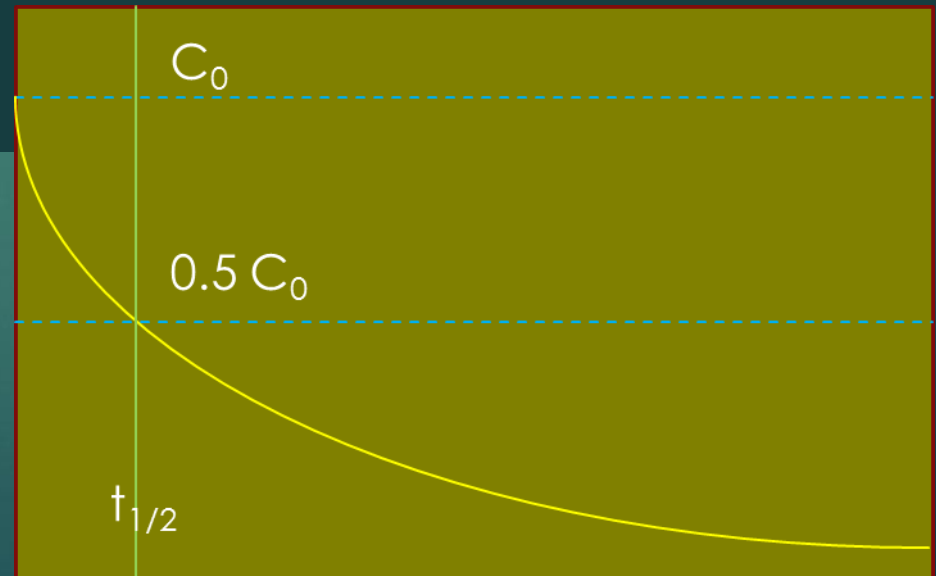

## Numerical solutions (simulations)

The best way to predict the situation (level 3 RBCA):

- taking into account variable area characteristics (both spatial and temporal)
- taking into account a number of phenomena
- the possibility of using different models of processes
- the ability to test different remediation options

- require a large amount of data (expensive field tests)
- the need for a good understanding and choice of the right solutions

# Numerical solutions (simulations)

MODFLOW – modeling groundwater flow  
developed by the US Geological Survey, free – the model itself;  
a number of commercial and free graphic interfaces

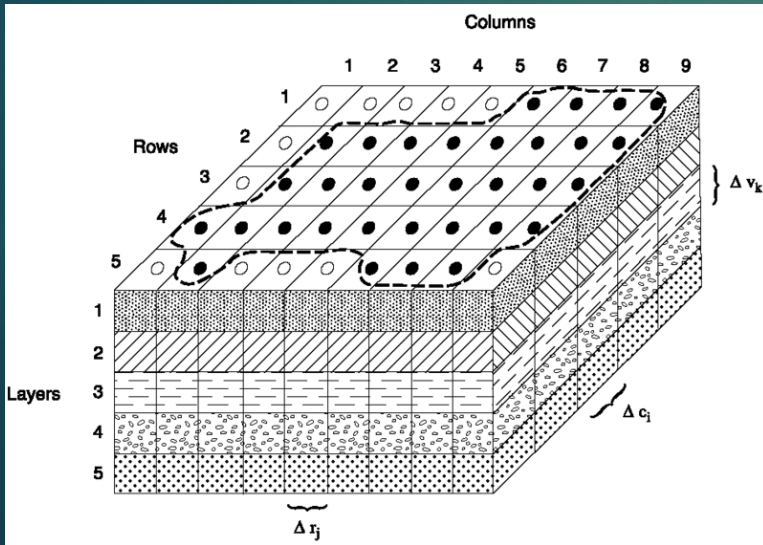

Source: Harbaugh, 2005

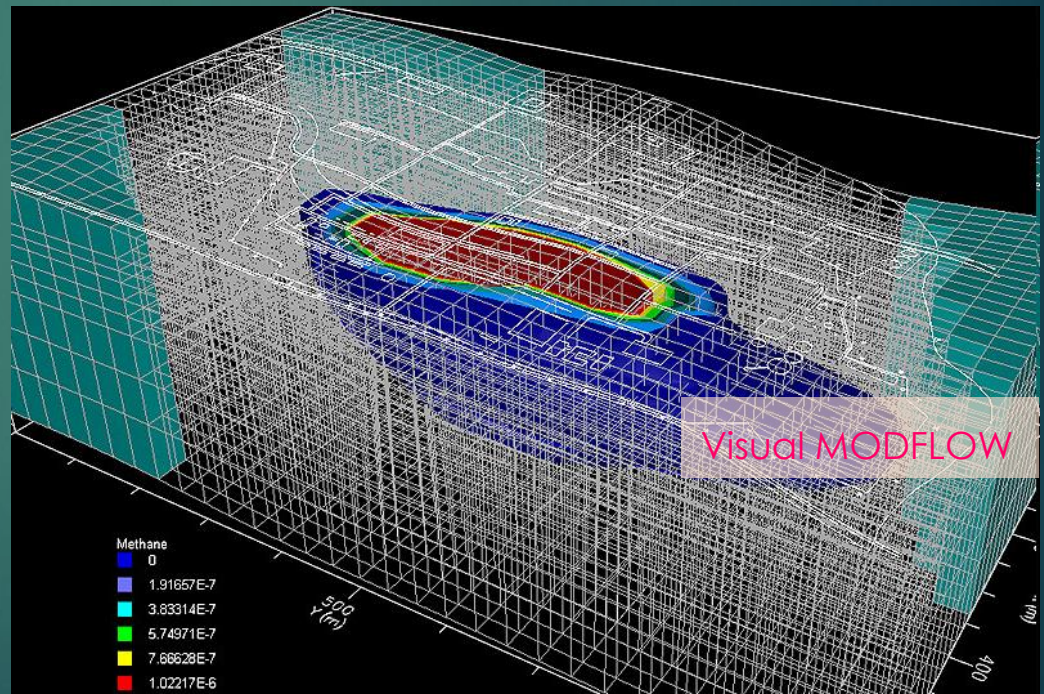

Source: www.delphitech.kz



## Numerical solutions (simulations)

265

RT3D – uses the results of the MODFLOW simulation  
hydrocarbons, chlorinated solvents; different electron acceptors; non-equilibrium sorbability etc.

Similarly commercial graphic interfaces.

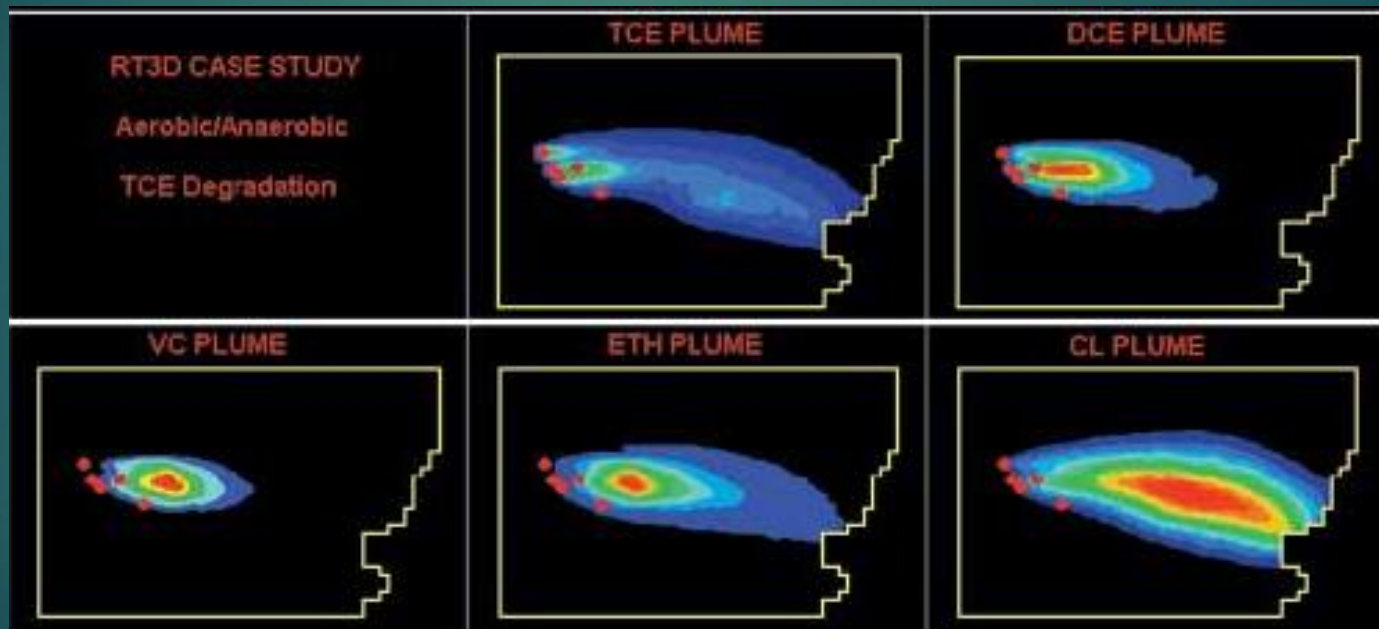

## BIOPLUME III

2-D modeling, only hydrocarbons. It is based on the US Geological Survey Method of Characteristics; fewer reaction options. Free.

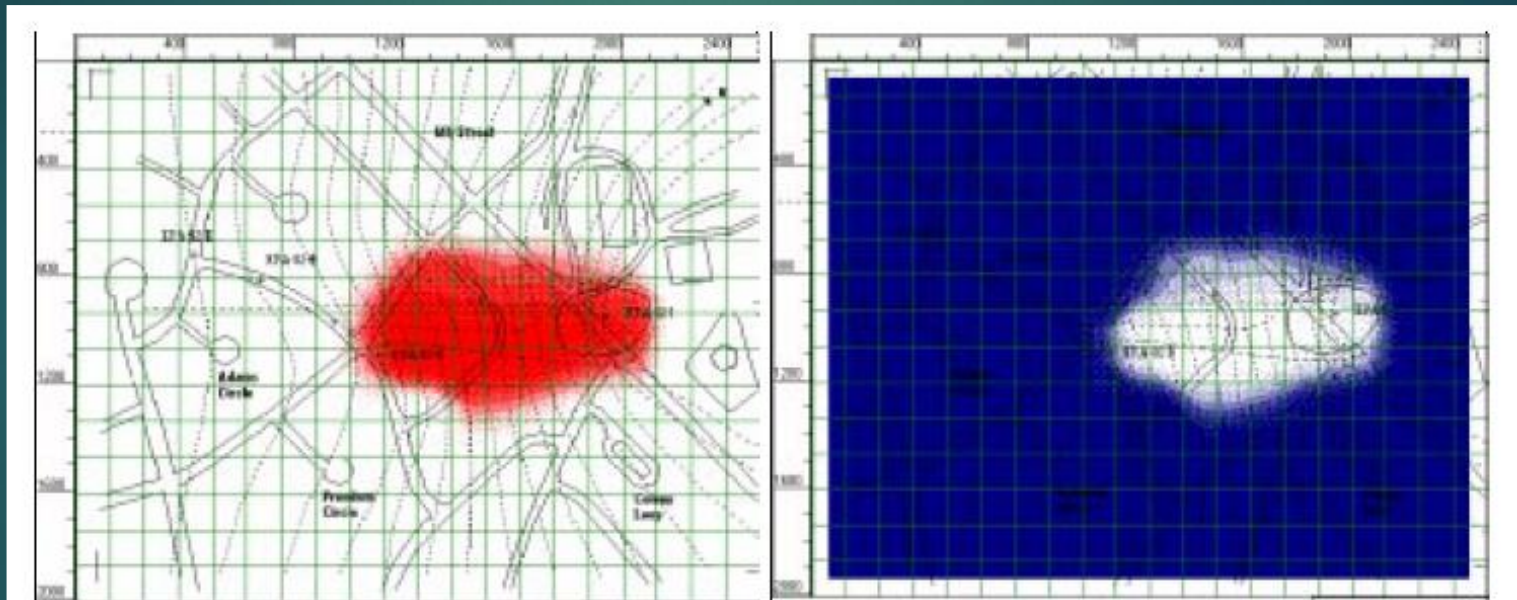

Figure 2.9 Plume Migration for BTEX and Oxygen After a 1 Year Simulation.

Based on arithmetical solutions (sometimes approximate) of differential equations of transport and degradation.

Simplified solutions – used at the screening stage (levels 1 and 2 of RBCA). accuracy of the order of magnitude.

- steady boundary conditions (concentration, time)
- homogeneous area characteristics, homogeneous flow
- simple geometry of the area
- they are not suitable, e.g. for fractured areas with significant vertical flows, etc.

+ offers the possibility of calculating using a spreadsheet.

Programs: BIOSCREEN, BIOSCREEN-AT, BIOCHLOR.

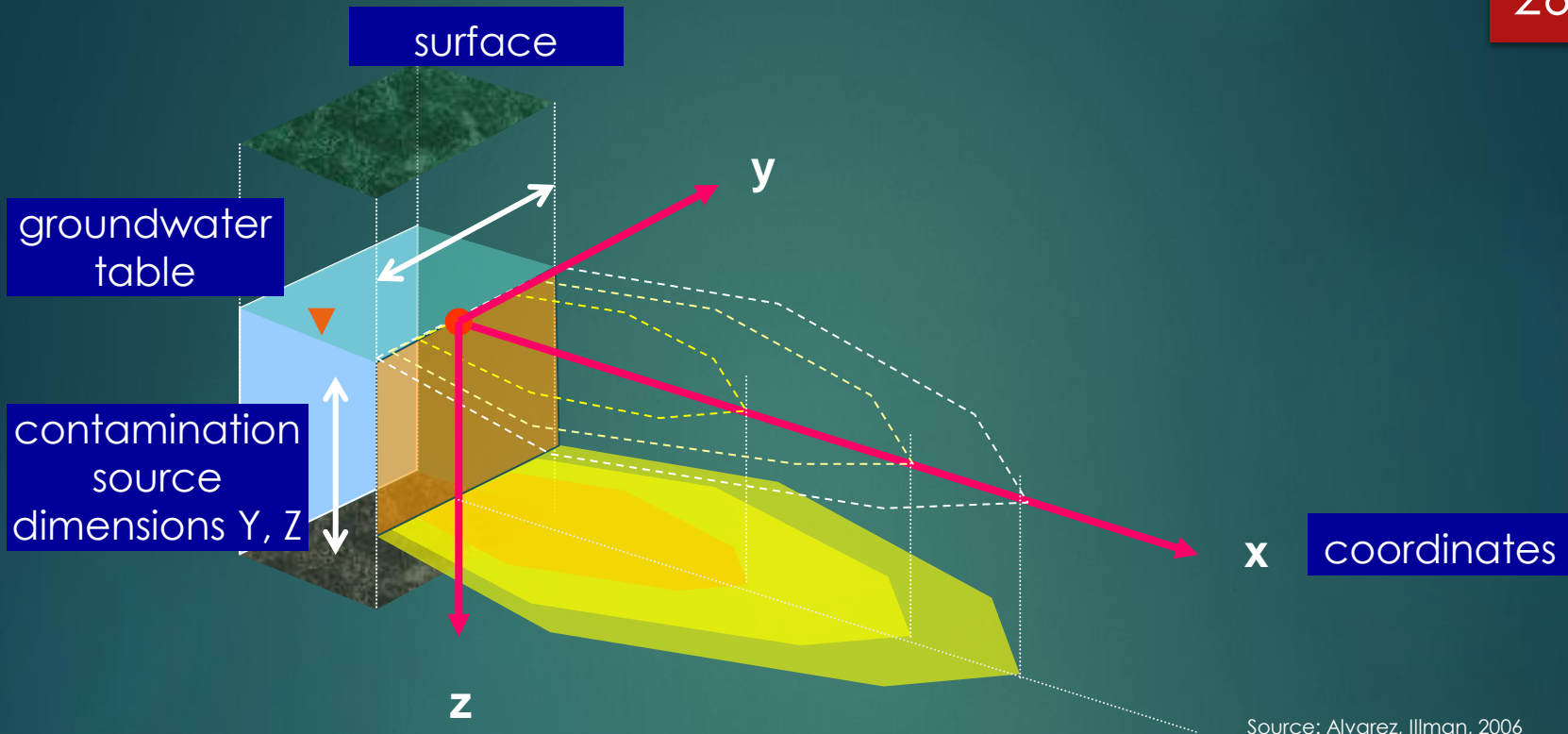

Concentration = 0 at  $t = 0$ ; aquifer homogenous and isotropic; homogeneous water flow field  $v_x$  constant,  $v_y v_z = 0$ ; flow fast enough to neglect diffusion in the hydrodynamic dispersion; the dispersion described by the Fick equation and the dispersion factor proportional to the flow rate; reversible and linear adsorption; biodegradation described by first order kinetics; constant rate of biodegradation.

## Case 1 – continuous source

269

$C_0 = \text{const,}$   
dimensions  
 $Y, Z$

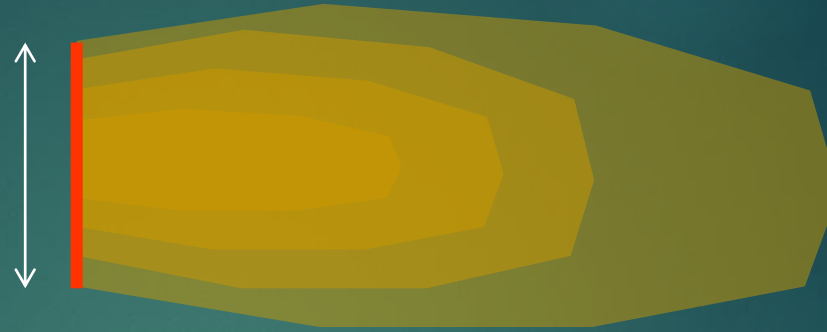

2 scenarios: transient (spreading); steady state (emission = degradation)

Domenico & Schwartz (1998), plume spreading:

$$C(x, y, z, t) = \left(\frac{C_0}{8}\right) \exp\left[\frac{x}{2\alpha_x}\left(1 - \sqrt{\frac{1+4\lambda\alpha_x}{v_c}}\right)\right] \times \text{erfc}\left[\frac{x - v_c t \sqrt{\frac{1+4\lambda\alpha_x}{v_c}}}{2\sqrt{\alpha_x v_c t}}\right] \times \left[\text{erf}\left(\frac{y+Y/2}{2\sqrt{\alpha_y x}}\right) - \text{erf}\left(\frac{y-Y/2}{2\sqrt{\alpha_y x}}\right)\right] \times \left[\text{erf}\left(\frac{z+Z}{2\sqrt{\alpha_z x}}\right) - \text{erf}\left(\frac{z-Z}{2\sqrt{\alpha_z x}}\right)\right]$$

where: erf (), erfc() – error function and complementary error function  
 $x$  – distance,  $y$  – distance from centerline,  $z$  – vertical distance from g. table  
 $t$  – time

$C_0$  – concentration at the source

$Y, Z$  – width and depth of the source

$v_c$  – contaminant velocity in groundwater (retardation included)

$\alpha$  – dispersivity:  $x$  – longitudinal,  $y$  – horizontal transverse,  $z$  – vertical transverse

$\lambda$  – site-specific first-order decay coefficient.

## Case 1 – continuous source

270

Steady state (emission = degradation) – maximal range of contamination plume (argument erfc approaches  $-2$ , then  $\text{erfc}(-2) = 2$ )

$$C(x, y, z, t) = \left( \frac{C_0}{4} \right) \exp \left[ \frac{x}{2\alpha_x} \left( 1 - \sqrt{\frac{1 + 4\lambda\alpha_x}{v_c}} \right) \right] \times \left[ \text{erf} \left( \frac{y + Y/2}{2\sqrt{\alpha_y x}} \right) - \text{erf} \left( \frac{y - Y/2}{2\sqrt{\alpha_y x}} \right) \right] \times \left[ \text{erf} \left( \frac{z + Z}{2\sqrt{\alpha_z x}} \right) - \text{erf} \left( \frac{z - Z}{2\sqrt{\alpha_z x}} \right) \right]$$

uses:

spreading – following situation development, e.g. when concentration in the given point exceeds permissible value?;

steady state – the worst scenario, e.g. if concentration in the given point exceeds permissible value?; what is the range of contamination?

# Case 2 – decaying source

$C_0$  only when  $t = 0$ , then is gradually declining (first order) dimensions  $Y, Z$

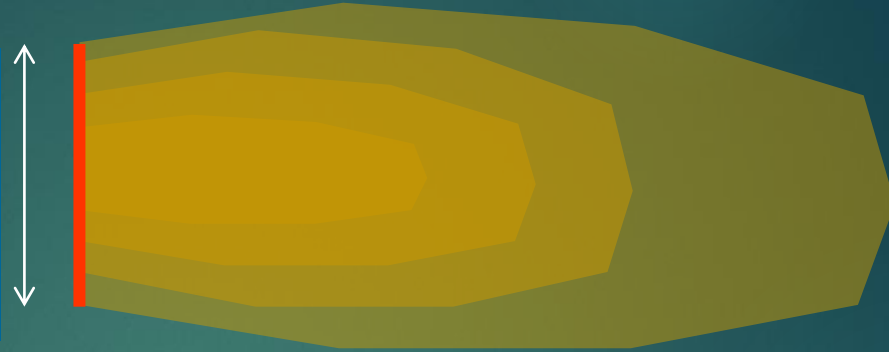

$$C(x, y, z, t) = \left( \frac{C_0 e^{-kt}}{8} \right) \exp \left[ \frac{x}{2\alpha_x} \left( 1 - \sqrt{\frac{1+4\lambda\alpha_x}{v_c}} \right) \right] \times \operatorname{erfc} \left[ \frac{x - v_c t \sqrt{\frac{1+4\lambda\alpha_x}{v_c}}}{2\sqrt{\alpha_x v_c t}} \right] \times \left[ \operatorname{erf} \left( \frac{y+Y/2}{2\sqrt{\alpha_y x}} \right) - \operatorname{erf} \left( \frac{y-Y/2}{2\sqrt{\alpha_y x}} \right) \right] \times \left[ \operatorname{erf} \left( \frac{z+Z}{2\sqrt{\alpha_z x}} \right) - \operatorname{erf} \left( \frac{z-Z}{2\sqrt{\alpha_z x}} \right) \right]$$

Assumption about reducing the concentration in the emission area according to the first-order function;  $k$  – decay rate constant (not to be confused with  $\lambda$  !!!)

$$\frac{dC}{dt} = k \times C$$

$$k = \frac{dC}{C dt}$$

$$k = \frac{\ln \left( \frac{C_0}{C} \right)}{\Delta t}$$

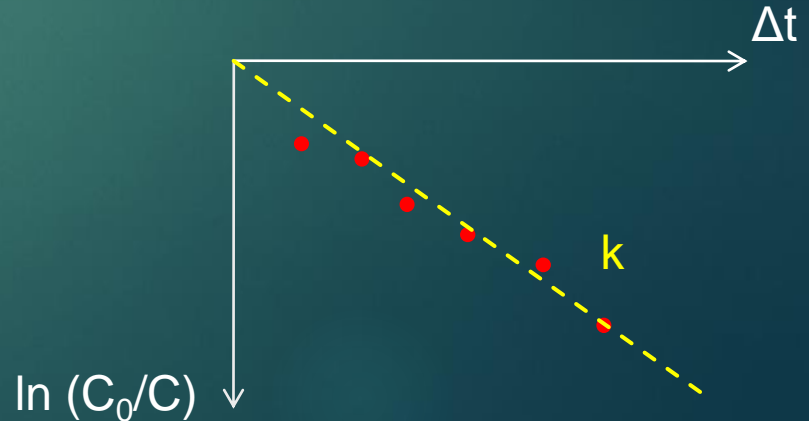

## Case 3 – instantaneous point source

272

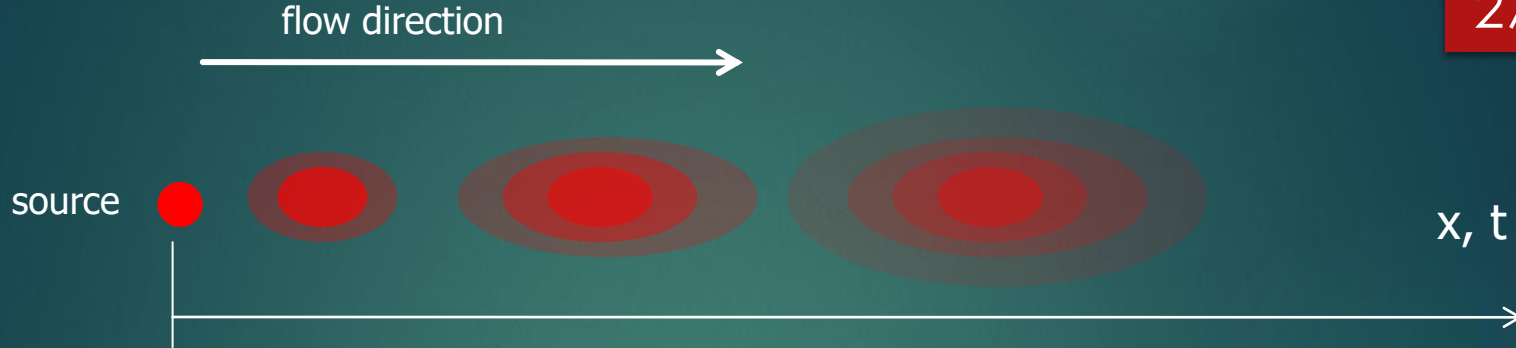

Baetsle (1969) – analytical solution

$$C(x, y, z, t) = \left( \frac{C_0 V_0}{8(\pi \times t)^{1.5} \sqrt{(D_X D_Y D_Z)}} \right) \exp \left( -\frac{(x - v_c \times t)^2}{4D_X t} - \frac{(y)^2}{4D_Y t} - \frac{(z)^2}{4D_Z t} - \lambda \times t \right)$$

where:

$x$  – distance,  $y$  – distance from centerline,  $z$  – vertical distance from g. table

$t$  – time

$C_0$  – concentration in the source

$V_0$  – contaminated volume of soil,  $C_0 \times V_0$  – initial mass of released contaminant

$v_c$  – contaminant velocity in groundwater (retardation included)

$D$  – dispersion coefficient along:  $x$  – axis,  $y$  – axis,  $z$  – axis;  $D = \alpha_i \times v_c$

$\lambda$  – site-specific first-order decay coefficient.



## IMPORTANT NOTE

The Domenico solution is an approximate solution, resulting in lower results than the exact solution, depending on the conditions. In 2007, a series of articles criticized it, as a result of which the use of this model in estimates was banned in some regions.

Recommended is use of alternative models, e.g. BIOSCREEN-AT; nevertheless, small errors occur if  $Pe \geq 10$  (dominance of advection over the dispersion).

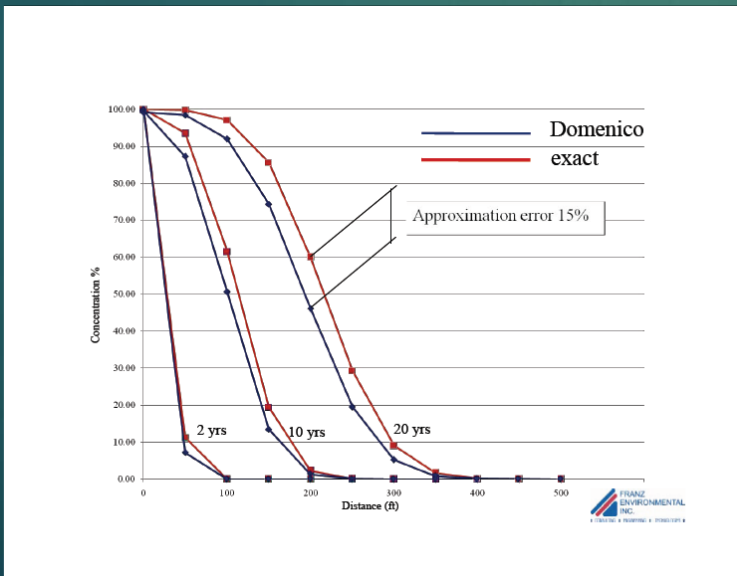

The screenshot shows the BIOSCREEN-AT Natural Attenuation Decision Support System interface. It includes a Microsoft Excel ribbon at the top and a main parameter input area. Key sections include:
 

- 1. HYDROGEOLOGY:** Seepage Velocity (Vs) = 1000.00 (ft/yr), Hydraulic Conductivity (K) = 8.1E-03 (cm/sec), Hydraulic Gradient (J) = 0.048 (ft/ft), Porosity (n) = 0.25 (-).
- 2. DISPERSION:** Longitudinal Dispersivity (alpha x) = 20.503 (ft), Transverse Dispersivity (alpha y) = 2.850 (ft), Vertical Dispersivity (alpha z) = 0.000 (ft), Estimated Plume Length (Lp) = 1450 (ft).
- 3. ADSORPTION:** Retardation Factor (R) = 1.2 (-), Soil Bulk Density (rho) = 2.65 (kg/ft³), Partition Coefficient (Koc) = 38 (L/kg), Fraction Organic Carbon (foc) = 8.8E-4 (-).
- 4. BIODEGRADATION:** 1st Order Decay Coeff (lambda) = 0.0E+00 (1/yr), Half-life (t-half) = 0.10 (year).
- 5. GENERAL:** Modeled Area Length = 1450 (ft), Modeled Area Width = 320 (ft), Simulation Time = 1.50 (yr).
- 6. SOURCE DATA:** Source Thickness = 10 (ft), Source Width = 100 (ft), Source Concentration = 9 (mg/L).
- 7. FIELD DATA FOR COMPARISON:** A table with columns for Concentration (mg/L) and Dist. from Source (ft).
- 8. CHOOSE TYPE OF OUTPUT TO SEE:** Buttons for 'RUN CENTERLINE', 'RUN PLUME', 'View Centerline', 'View Plume', and 'View BIOSCREEN'.

 A 3D visualization of the plume is shown on the right side of the interface.

# Determination of parameters for modelling pollution transport and degradation

274

- 1) hydraulic gradient  $dh/dx$
- 2) hydraulic conductivity (K), m/d
- 3) total porosity ( $\phi$ )
- 4) effective porosity ( $\phi_e$ )
- 5) fraction of organic carbon (SOM),  $f_{oc}$
- 6) bulk density ( $\rho_b$ ),  $kg/dm^3$
- 7) dispersion: longitudinal ( $\alpha_x$ ), horizontal ( $\alpha_y$ ), vertical ( $\alpha_z$ ), m
- 8) dispersion coefficient D, as above, ( $D_i = \alpha_i \times v_c$ )
- 9) degradation rate coefficient ( $\lambda$ ), 1/d

1, 2, 4  $\rightarrow$  necessary for calculation of groundwater velocity  $v$

3, 5, 6 +  $K_{oc}$  for contaminant  $\rightarrow$  retardation coefficient  $R_f$

combined  $\rightarrow$  advective velocity of contaminant  $v_c$

# Hydraulic gradient

275

Determination of hydraulic gradient and groundwater flow direction – development of hydrogeological map of the area (determination of hydroizohypses).

$$\text{hydraulic gradient} = \Delta h / \Delta x$$



Measurement of hydraulic head – wells, piezometers. Hydraulic head = surface height above sea level (map) – distance to water level in a well.

Measurement: manual; automatic: e.g. pressure transducers (variations of groundwater table).

# Hydraulic gradient

276

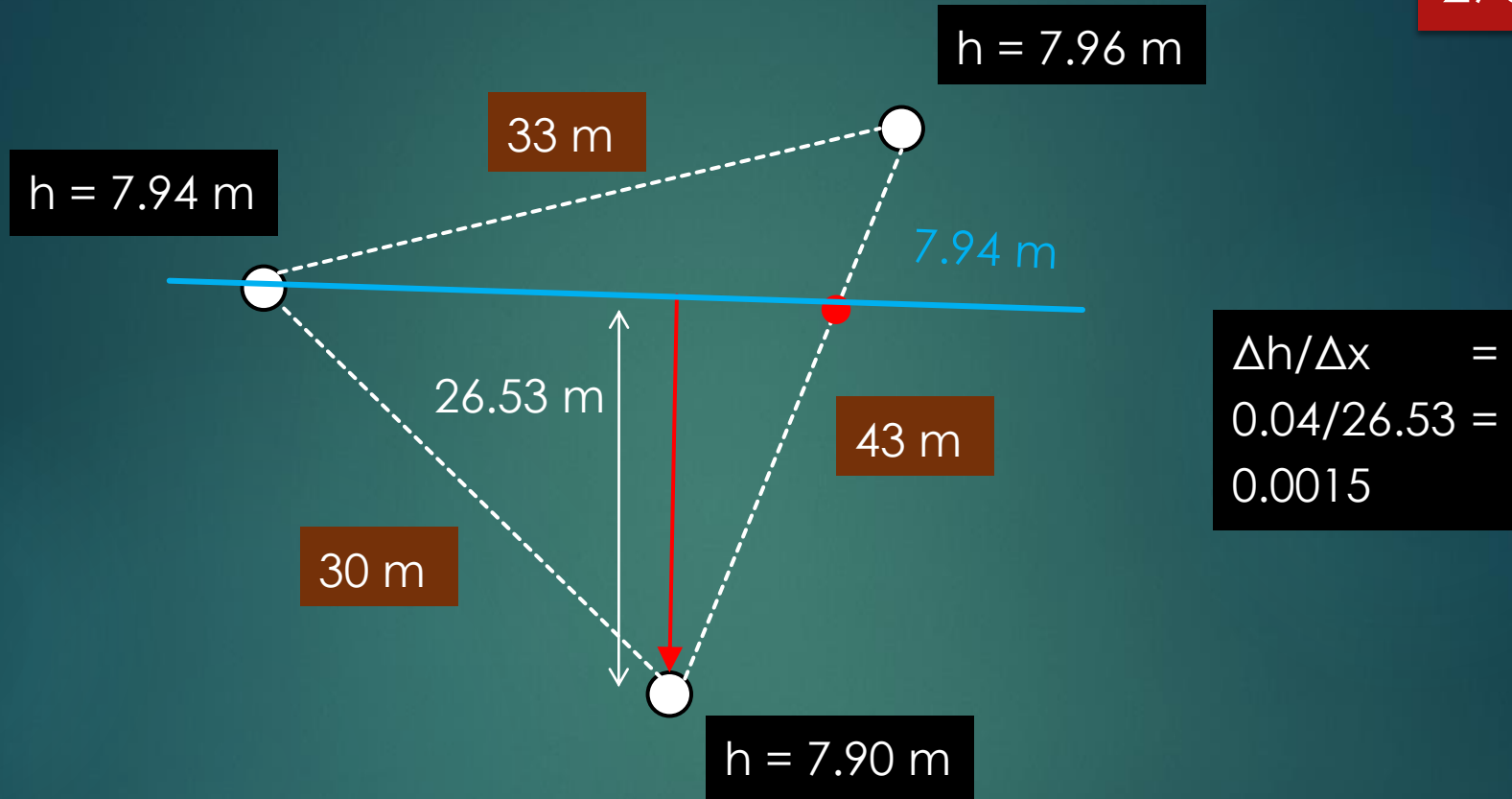

Large number of measurement points necessary, also outside boundaries of the considered area must be established.

3-D measurements (temporal variability of groundwater table; via a group of nested wells of different depth – vertical hydraulic gradient, vertical flows).

- ◆ laboratory tests
- ◆ estimations based on grain size analysis (sieving):
  - e.g. according to Hazen  $K = C * d_{10}^2$  [cm/s]
  - where C – constant dependent on soil type;  $d_{10}$  – effective grain size (10%, by weight, with finer grains) [mm]

mean grain size	sorting (homogeneity)	C
very fine to fine sand	poorly to moderately sorted	40–80
medium sand	well sorted	80–120
coarse sand	poorly sorted	80–120
coarse sand	well sorted	120–150

Source: Alvarez, Illman, 2006

Other methods: Harleman, Krumbein and Monk, Kozeny, Shepherd, etc.  
Effective for loose soils, such as silt, sands, gravels. Does not work with high content of clayey fraction (clays).

◆ field tests: slug and bail test

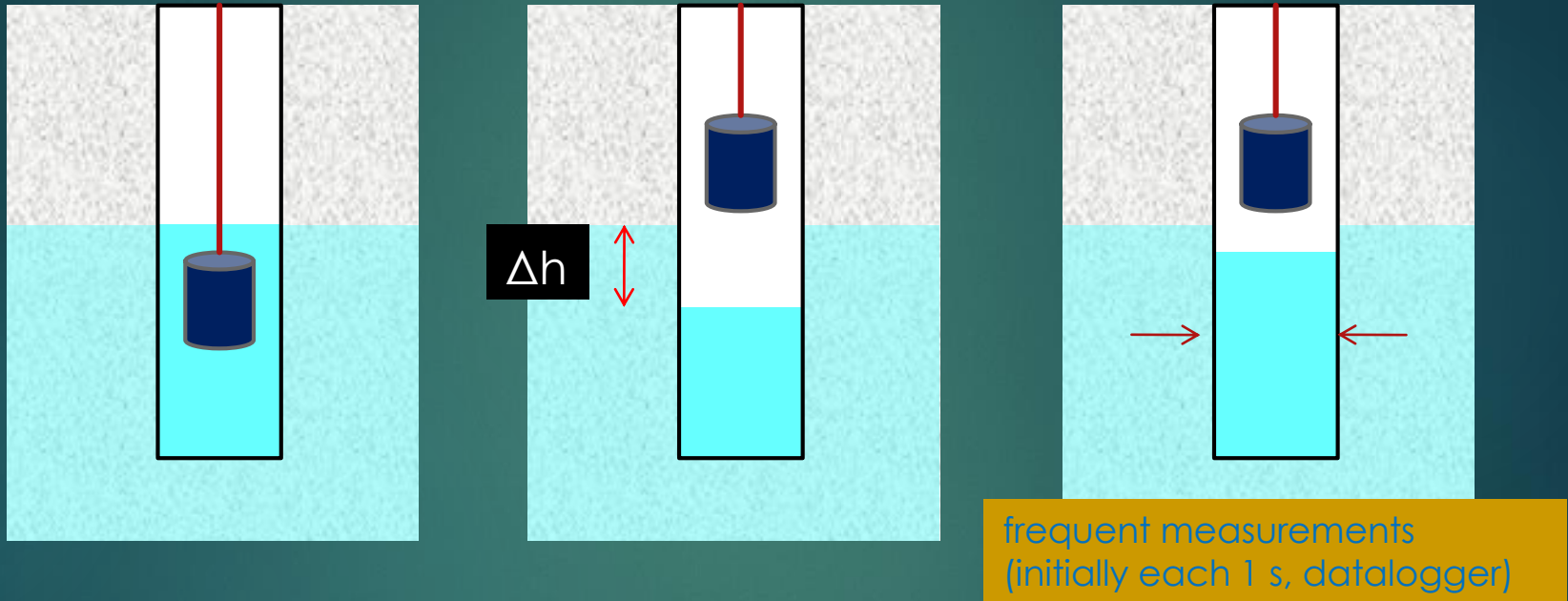

Methods, e.g. Bouwer and Rice (1976); Dawson and Istok, Kruseman and de Ridder, Wiedemeier, Bulter. Rising or falling head test.

- + simple, short, inexpensive; no need for pumping contaminated water
- representative only to vicinity of monitoring well

- ◆ field tests: pumping
- ◆ unconfined or confined aquifers

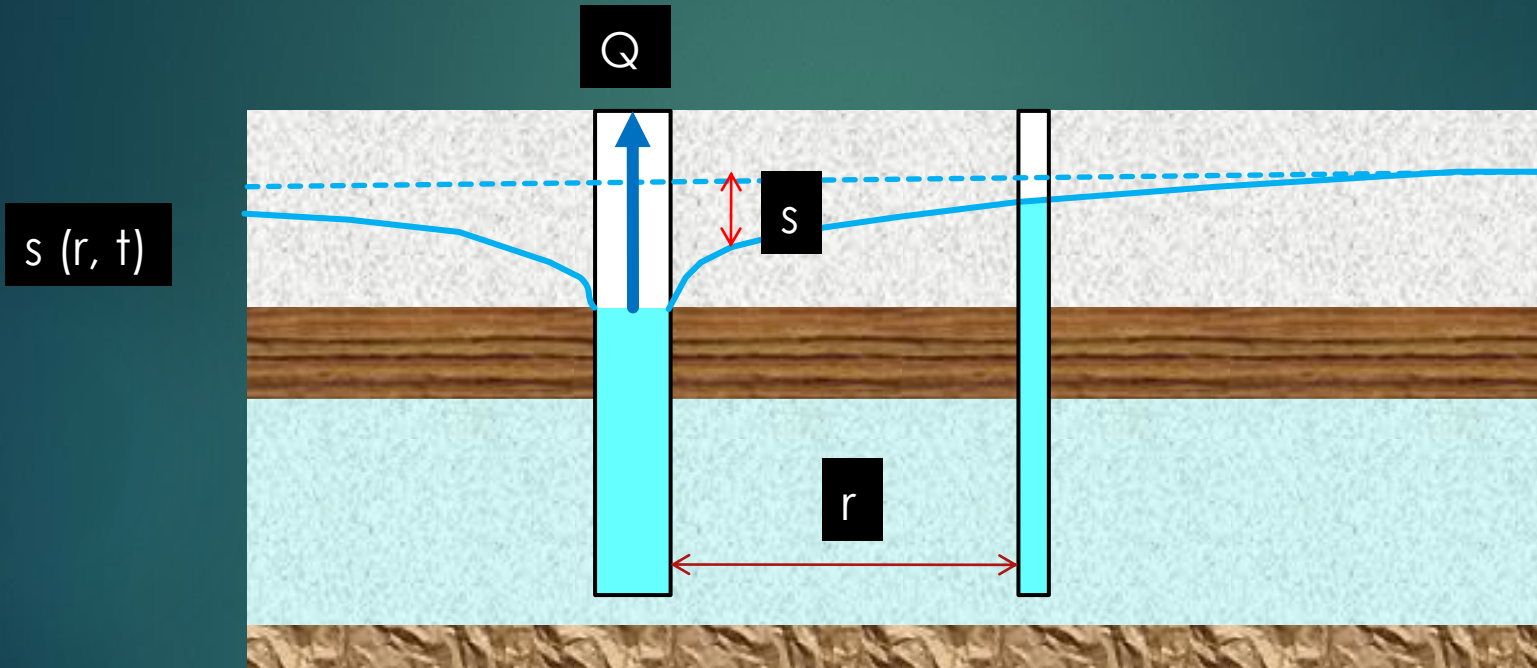

Source:  
Alvarez, Illman, 2006

confined aquifer: Theis; Jacob-Cooper methods  
unconfined aquifer: Neumann method

+ measurement representative for a larger area

# Total porosity, effective porosity and bulk density

280

- ▶ total porosity: volume of voids divided by total volume of soil; equivalent to moisture content under saturated conditions
- ▶ bulk density: mass of soil sample divided by its volume; lab test
- ▶ effective porosity: pores available for groundwater flow; always smaller than total porosity; determined by the tracer test method (e.g. using bromines); the volume of the pumped solution needed to reach 50% of the initial concentration

soil	bulk density, kg/m <sup>3</sup>	total porosity	effective porosity
clay	1–2.4	0.34–0.60	0.01–0.2
sandy clay			0.03–0.2
silt		0.34–0.61	0.01–0.3
loess	0.75–1.6		0.15–0.33
fine sand	1.37–1.81	0.26–0.53	0.1–0.3
medium sand	1.37–1.81		0.15–0.3
coarse sand	1.37–1.81	0.31–0.46	0.2–0.35



## Dispersivity and hydrodynamic dispersion coefficient

### Longitudinal dispersivity $\alpha_x$

- Gelhar (1993), empirical:  $\alpha_x = 0.1 \times L$  (average distance travelled by contamination plume; usually its length)
- Neuman (1990), also empirical, but more precise:  
 $\alpha_x = 0.0175 \times L^{1.46}$  ( $L \leq 100$  m),  $\alpha_x = 0.32 \times L^{0.83}$  ( $L > 100$  m)
- other empirical methods, e.g. geostatistical method
- testing: observation of tracer concentration in time in sample core (column) effluent (van Genuchten & Wierenga, 1986)

Transverse and vertical dispersivity – typically assumed as 30% and 5% of longitudinal dispersivity, respectively.

## Retardation coefficient

282

$$R_f = 1 + K_d \rho_b / \phi$$

$$K_d \text{ distribution coefficient} = K_{OC} \times f_{OC}$$

where:

$K_{OC}$  soil adsorption coefficient for organic carbon

$f_{OC}$  fraction of organic carbon in soil

$\rho_b$  bulk density

$\phi$  total porosity

Observations indicate that retardation coefficient may not be constant and may increase until steady state is reached.

e.g. for nitrobenzene  $\log K_{OC} = 1.66$

$$K_{OC} = 10^{1.66} = 45.71$$

assuming  $f_{OC} = 0.005$  (0.5%),  $\rho_b = 1.86 \text{ kg/m}^3$ ,  $\phi = 0.3$

$$R_f = 1 + (45.71 \times 0.005 \times 1.86) / 0.3 = 1.42$$

then,  $v_c$  velocity is 1.42 times lower than groundwater flow linear velocity.

compound	Log $K_{oc}$
chloroform (trichloromethane)	1.92
dichloromethane	1.41
tribromomethane	2.40
tetrachloromethane	2.18
1,2-dichloroethan	1.48
tetrachloroethylene	2.57
trichloroethylene	2.38
benzene	1.92
chlorobenzene	2.63
ethylbenzene	3.15
phenol	1.27
toluene	2.48
o-ksylene	2.95
2-chlorophenol	1.96
2,4-dichlorophenol	2.90
2,4,6-trichlorophenol	3.87
lindane	3.51
2,4-D	1.65
MCPA	1.50

Values given as decimal logarithms! To estimate  $K_{oc}$ , it is necessary to calculate  $10^x$ .

## \* Mass balance

requires extensive amount of time and numerous measurements in well clusters, at different depths; no inflows or other dissipation routes; very precise.

## \* Buscheck and Alcantar method

only for constant source, steady state plume; concentration measurements along central line of plume; may overestimate  $\lambda$  because it does not include horizontal and vertical dispersion.

## \* TMB normalization

concentration comparison along central line for biodegradable contaminant and conservative (recalcitrant) tracer present in leak (np. trimethylbenzene, tetramethylbenzene). It includes other processes, nonsteady plumes; degradation and increased retardation of tracer causes underestimations of  $\lambda$ .

## \* Fitting the simulation to the data from the contaminated area

large influence of inaccurate estimations of other parameters.

## \* in-situ microcosms

Filled with isolate from aquifer, added tracer (np. tritium) and investigated compound. Concentrations measurements.

Necessary to monitor redox conditions – some isolation (availability of electron acceptors); necessary to include sorption in calculations.

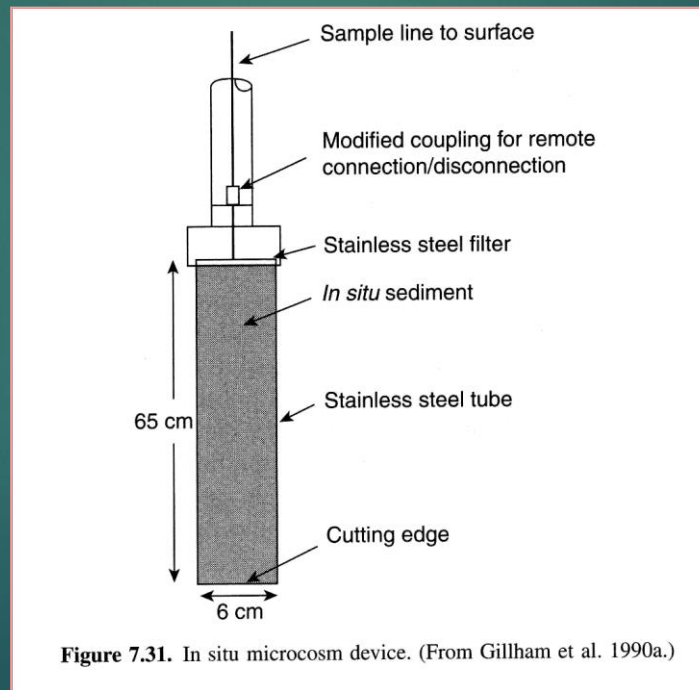

# Biodegradation rate coefficient

\* “push and pull” tests (e.g. Haggerty et al. 1998)

First phase: injection of contaminant and trace solution (e.g. bromide) to aquifer; second phase pumping out.

Comparison of both substances concentration in time, also search for metabolites.

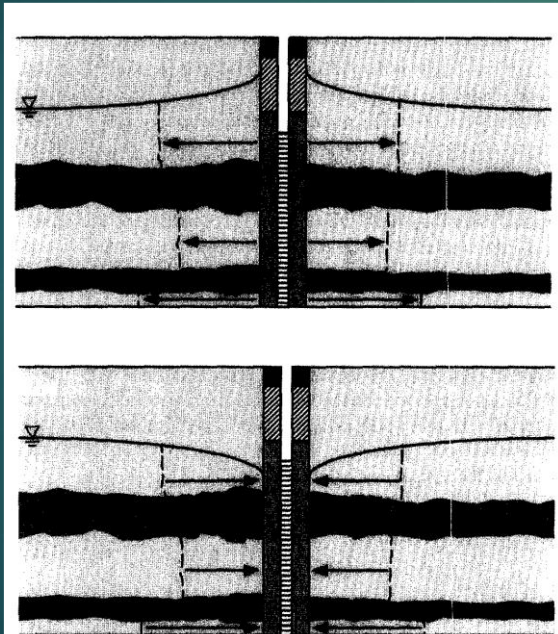

Figure 1. Schematic of a push-pull test in a heterogeneous, unconfined aquifer.

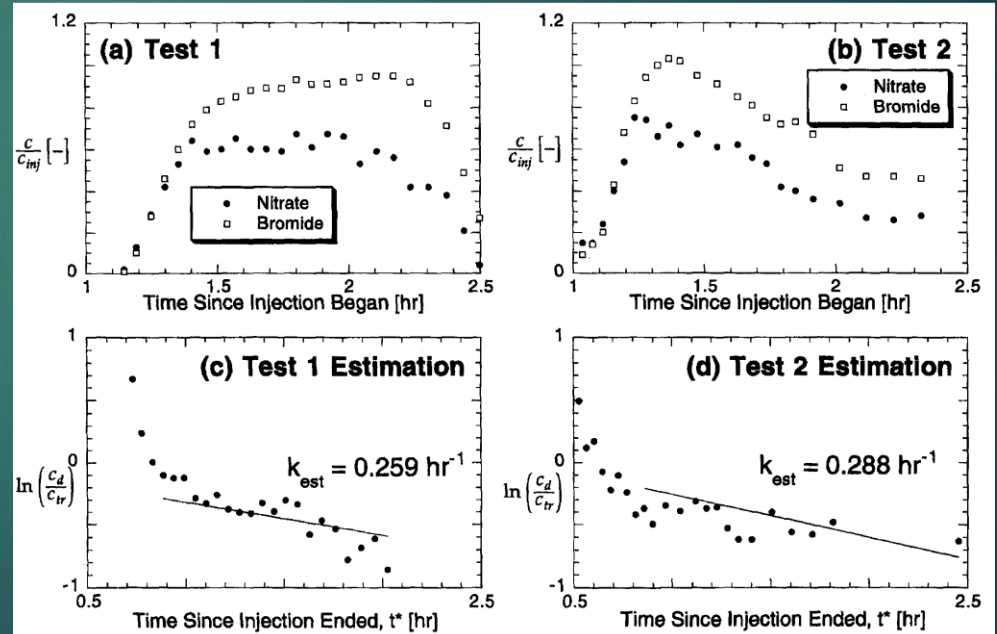

Figure 7. Tracer and reactant breakthrough curves, and corresponding estimation graphs for the determination of denitrification rates for two push-pull tests conducted in different monitoring wells in a petroleum contaminated aquifer (Schroth et al. 1997).

# Problem

ENVIRONMENTAL AND LAND ENGINEERING



**SOIL REMEDIATION  
PROJECT CLASSES**

**Project 1: Prediction of risk by contaminant plume spread**

student: .....

Point "X" (see map below) is the source of groundwater contamination by .....  
at concentration according to the table below. The pollution zone width is  $Y =$  ..... m; depth  $Z =$  ..... m. A, B, C are the locations of groundwater intakes.

day	concentration, mg/dm <sup>3</sup>
0	
10	
50	
100	
200	
300	

Groundwater table (m below surface level)

X .....  
A .....  
B .....  
C .....

hydraulic conductivity  $K_h$  ..... m/d;  
total porosity  $\phi$  .....;  
effective porosity  $\phi_e$  .....;  
organic carbon .....  
soil bulk density  $\rho$  ..... kg/m<sup>3</sup>

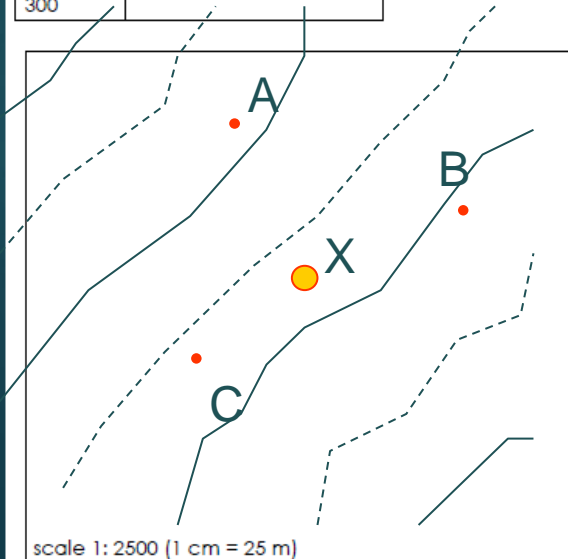

Perform risk assessment for groundwater intakes in points A, B, C, on the basis of:

- transport and fate of pollution emitted from point "X"
- drinking water quality standards.

Regardless of the predicted risk, present and discuss possible remediation solutions.

# Problem

ENVIRONMENTAL AND LAND ENGINEERING



**SOIL REMEDIATION  
PROJECT CLASSES**

**Project 1: Prediction of risk by contaminant plume spread**

student: .....

Point "X" (see map below) is the source of groundwater contamination by .....  
at concentration according to the table below. The pollution zone width is  $Y =$  ..... m; depth  $Z =$  ..... m. A, B, C are the locations of groundwater intakes.

day	concentration, mg/dm <sup>3</sup>
0	
10	
50	
100	
200	
300	

Groundwater table (m below surface level)  
 X .....  
 A .....  
 B .....  
 C .....

hydraulic conductivity  $K_h$  ..... m/d;  
 total porosity  $\phi$  .....;  
 effective porosity  $\phi_e$  .....;  
 organic carbon .....  
 soil bulk density  $\rho$  ..... kg/m<sup>3</sup>

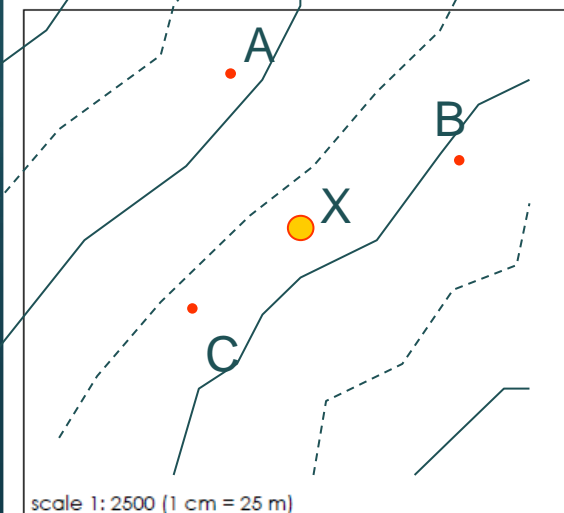

## Source type:

- constant (Domienico)
- decaying (determine k constant)
- instantaneous ?

## Calculate retardation coefficient.

Determine hydraulic head in all points; determine flow direction and hydraulic gradient.

Determine endangered point (intake) and its coordinates  $x, y$  (assume  $z = 0$ ).

Calculate groundwater flow linear velocity and velocity of contaminant transport; calculate dispersivity (dispersion coefficient) in  $x, y, z$  directions (assume  $L = x$  value for endangered point).



# Determination of flow direction and hydraulic gradient

289

1. For X, A, B, C points: determine surface height – interpolation from map contour lines.
2. For Z, A, B, C points: determine hydraulic heads by subtracting given water table depths from surface heights.
3. Among points A, B, C: discard this with hydraulic head  $\geq$  point X (water does not flow upwards). For example below, discard point C.

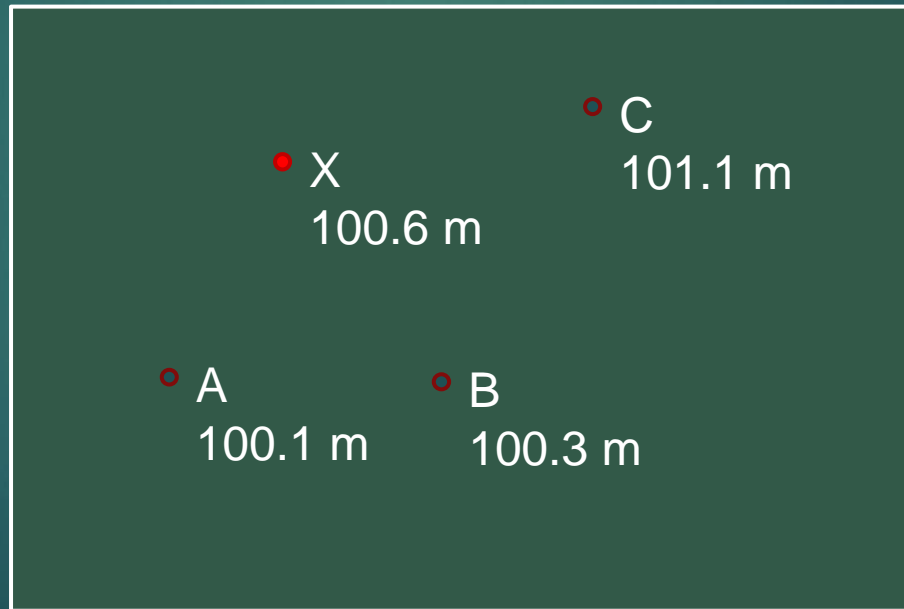

4. For the rest of the points (X, A, B in the example), on the line joining point with the highest hydraulic head (here, X) and the lowest (here, A) interpolate a point with hydraulic head corresponding to the middle point (here, B at 100.3 m).

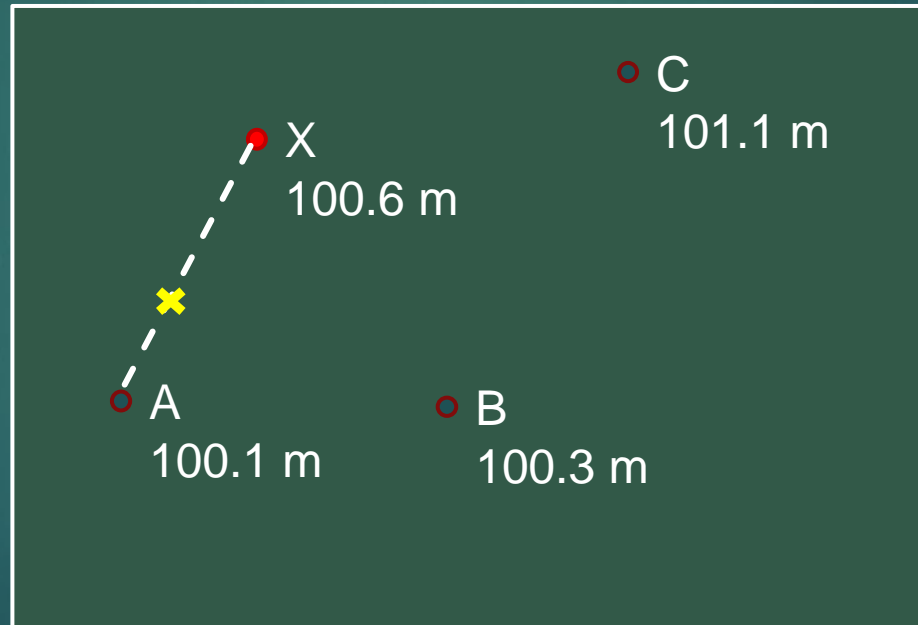

# Determination of flow direction and hydraulic gradient

291

5. Draw a line between the middle point (here, B) and the interpolated point. This is a hydroizohypsis of 100.3 m height.

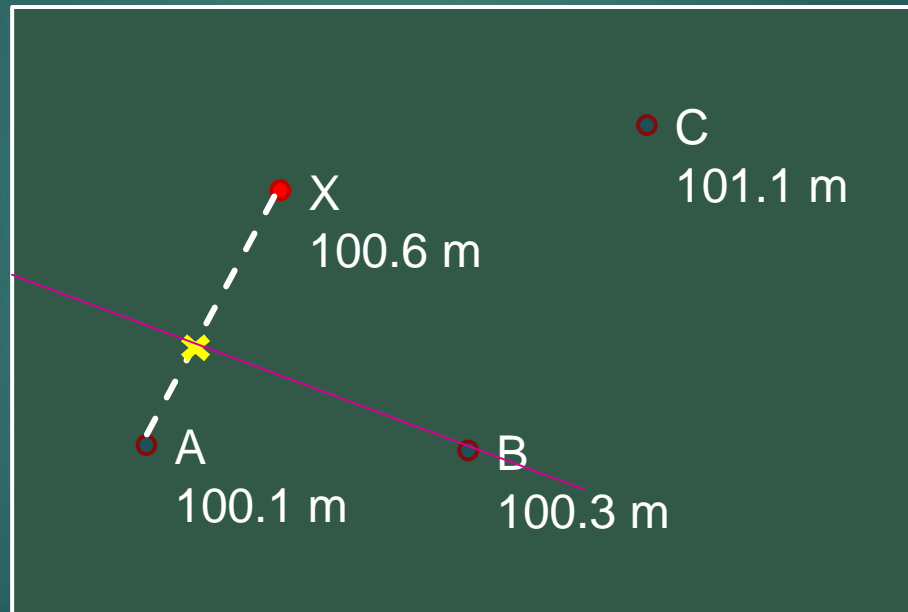

# Determination of flow direction and hydraulic gradient

292

- Flow direction is perpendicular to determined hydroizohypsis and begins at point X. The most endangered point is then point A.

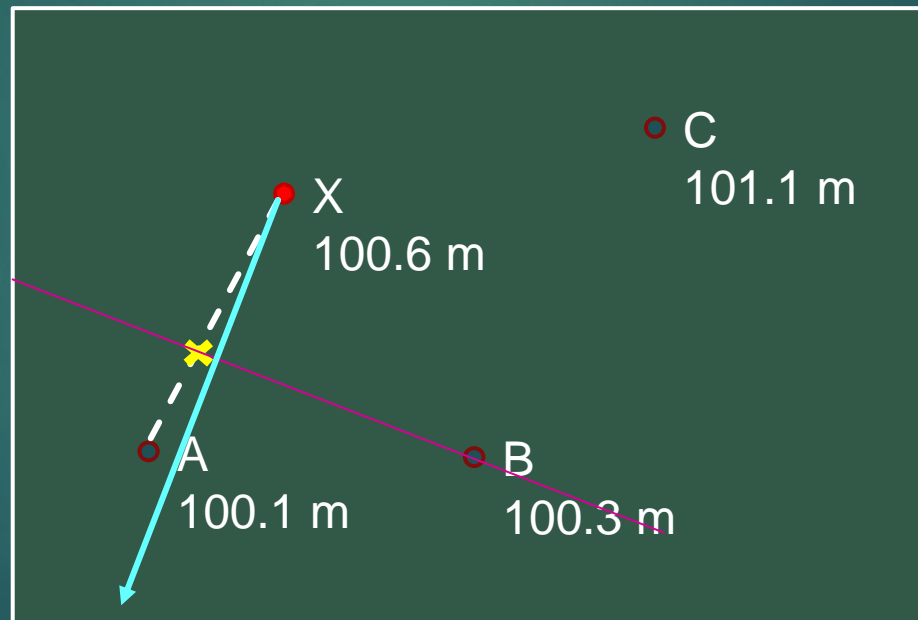

# Determination of flow direction and hydraulic gradient

293

7. Determined flow direction is also an x axis for the contaminant plume. Value of x coordinate for point A is measured along this axis, and the y coordinate is perpendicular to it. These coordinates are to be used in your calculations.
8. Hydraulic gradient is calculated taking the difference between hydraulic heads of X point and the endangered point (here, 0.5 m) as  $\Delta h$ .  $\Delta x$  is equal to the x coordinate and is measured along the flow direction axis.

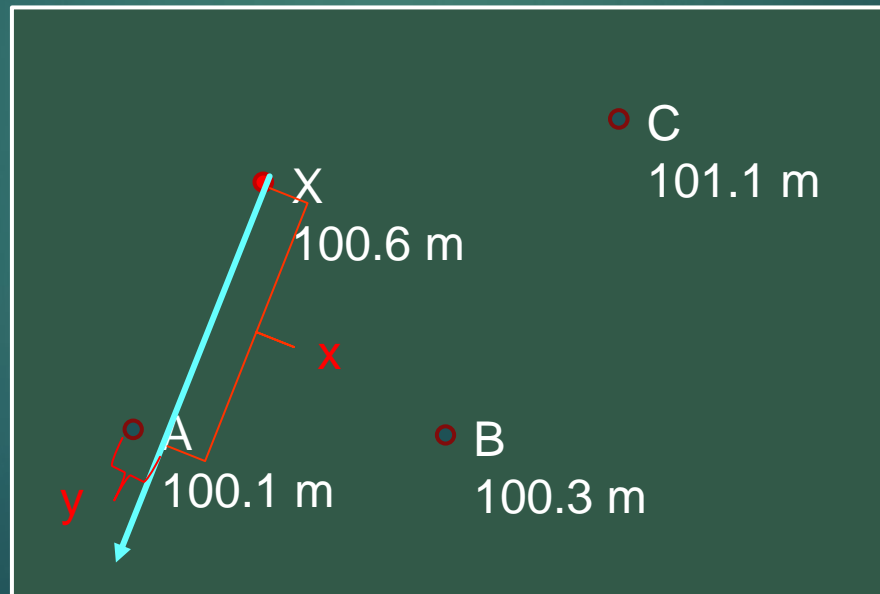

ENVIRONMENTAL AND LAND ENGINEERING



**SOIL REMEDIATION  
PROJECT CLASSES**

**Project 1: Prediction of risk by contaminant plume spread**

student: .....

Point "X" (see map below) is the source of groundwater contamination by .....  
at concentration according to the table below. The pollution zone width is  $Y =$  ..... m; depth  $Z =$  ..... m. A, B, C are the locations of groundwater intakes.

day	concentration, mg/dm <sup>3</sup>
0	
10	
50	
100	
200	
300	

Groundwater table (m below surface level)  
 X .....  
 A .....  
 B .....  
 C .....

hydraulic conductivity  $K_h$  ..... m/d;  
 total porosity  $\phi$  .....;  
 effective porosity  $\phi_e$  .....;  
 organic carbon .....;  
 soil bulk density  $\rho$  ..... kg/m<sup>3</sup>

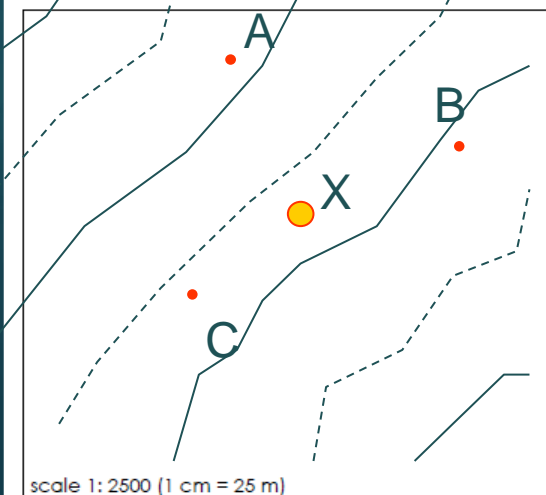

Consult the first part of the project for the  $\lambda$  value (slide 5).

Perform calculations of C in the endangered point in relation to time (spreadsheet, initially assume e.g. 10 d step for 1000 d, i.e. 100 steps).

Compare C to drinking water quality standards, groundwater quality standards, e.g.:

- Polish
- your country
- WHO guidelines ([http://www.who.int/water\\_sanitation\\_health/publications/2011/dwq\\_guidelines/en/](http://www.who.int/water_sanitation_health/publications/2011/dwq_guidelines/en/))
- EPA standards
- etc.

Discuss the results.

## Possible problem with erf and erfc

In older versions of spreadsheets it is not possible to calculate the value of the erf function (erfc) if the argument (x) has a negative value (error note appears). If such a problem arises, it can be solved by using the following relationships:

$$1) \operatorname{erf}(-x) = -\operatorname{erf}(x)$$

$$2) \operatorname{erfc}(x) = 1 - \operatorname{erf}(x)$$

$$3) \operatorname{erfc}(-x) = 1 + \operatorname{erf}(x)$$

For example, if x is negative, the value of erf can be calculated (case 1) by changing the sign x and assuming a negative value from the function calculated in this way, e.g.:

$$\operatorname{erf}(-1) = -\operatorname{erf}(1)$$

Laboratory class 1

**Basic physical and chemical  
properties of soil**

**Biotests**



## 1. Introduction

Recognition of soil pollution and proper execution of remediation requires knowledge of soil properties and hydrogeological situations. Among these parameters are:

→ **classification of soil type (texture)**, basing on weight proportions of basic mineral components: sand (particles of 0.05–2 mm size), silt (0.002–0.05 mm) and clay (<0.002 mm). Separation of sand can be done mechanically, using sieves; for silt and clay – more complicated methods should be used, e.g. based on differences in settling time for particles of different sizes. Type of soil can be read using different “triangles” e.g. according to US Department of Agriculture classification:

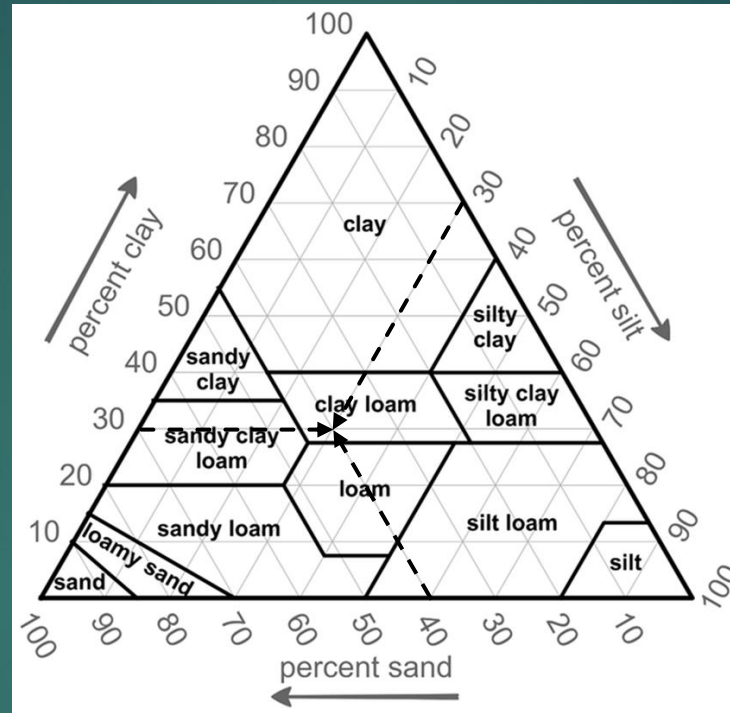

For example, soil containing 40% sand by weight, 30% silt and 30% of clay is classified as clay loam (in the above figure). Separation of sand fraction is often done more in detail, distinguishing several particle sizes (granulometric analysis or grain size analysis).

- **Moisture content** of soil: This is water content by weight, determined by soil drying at 105°C (mass loss).
- **Organic matter content** (by weight): This can be determined by several methods: as a mass loss on ignition (550°C), by the amount of CO<sub>2</sub> generated during dry combustion at 900°C, or by amount of dichromate used during wet oxidation of soil sample.
- **Nitrogen content**: determined by dry combustion and measurement of N<sub>2</sub> gas evolution (elemental analysis). Another method is Kjeldahl digestion: conversion of organic N into NH<sub>4</sub><sup>+</sup> and then determination of NH<sub>4</sub><sup>+</sup>. Inorganic nitrogen – ammonium, nitrite and nitrate – are measured by extracting them from soil using 0.01 M CaCl<sub>2</sub> solution and then determining e.g. photometrically.
- **Phosphorus content**: phosphorus is extracted from soil using sulphuric and hydrofluoric acids and hydrogen peroxide. Phosphorus content in the extract can be determined spectrophotometrically.
- **Soil pH** is a very important parameter for maintaining optimal conditions for pollutant degrading microorganisms. Herein, pH measures the activity of H<sup>+</sup>

and  $\text{H}_3\text{O}^+$  ions in a solution. Acidity of soil results from presence of organic and carbonic acids, and also  $\text{Al}_3^+$  and  $\text{Fe}_3^+$  ions. Soil pH measurements are usually done by mixing soil with water (only easily dissociated  $\text{H}^+$ ) or with 1 M KCl or 0.01 M  $\text{CaCl}_2$  solutions, which also mobilizes exchangeable  $\text{H}^+$ . The latter solutions simulate soil solutions of arable soils ( $\text{CaCl}_2$ ) or forest soils (KCl).

- **Water holding capacity:** amount of water that soil can hold, without dripping.
- **Bulk density:** it is the ratio of mass of dry soil to its volume in the natural state (including pores). This can be measured only using soil samples taken in their natural state.
- **Porosity:** it is the percentage of pores volume in the total volume of soil, and can be calculated from bulk density.
- **Pore size distribution** gives the information about distribution of pore sizes in soil that affects its aeration, permeability, transport of pollutants and the water-retention. It cannot be determined directly; it could be established by estimating water content at different matric potentials.

There are several parameters that must be measured directly in the field to characterize the site and calculate pollutant spread: hydraulic gradient, hydraulic conductivity, total and effective porosity, dispersivity and biodegradation rate coefficients. These will be discussed in detail during project classes.

Biotests (or bioassays) are widely used to characterize soil pollution (toxicity) and associated risk. Comparing to chemical analysis, which are very accurate but selective, biotests provide information about actual toxicity, including effects such as: bioavailability of pollutants in real conditions, as well as the effects of multiple (mixed) contaminants and their metabolites (synergistic, antagonistic or additive). Their disadvantages, however, are that the results could be affected by soil properties (like pH, texture) and that the effects are related to the test organisms, which could happen to be very sensitive or resistant to certain toxins. The latter could be avoided by applying a set of biotests with a range of different test organisms (battery of biotests).

Tests could be done using soil or soil extracts (e.g. water extracts). They may investigate the habitat function of soil (i.e. soil as a place for living organisms). In such case, testing is usually done at different trophic levels: producers

(e.g. plants), consumers (e.g. animals, fauna) and reducers (decomposers, e.g. bacteria or other microorganisms). Another use of biotests is to estimate retention function of soil as a source of groundwater. Herein, tests on water extracts are rather used.

Different endpoints (effects) are assessed in biotests, such as: avoidance or other behaviour changes, reproduction, mortality, growth inhibition, mutagenity and genotoxicity. Effects should be compared to a reference sample: clean soil and/or artificial soil.

Selected examples of biotests are:

- ecotoxicity of water extract: luminescence inhibition of *Vibrio fischeri* (Microtox); growth inhibition of algae *Desmodesmus subspicatus*,
- genotoxicity of water extract: Umu test and Amu test with genetically modified *Salmonella* species,
- soil microorganisms: respiration and ammonium oxidation,
- soil fauna: mortality and reproduction of earthworms *Eisenia foetida* or *E. andrei*, reproduction of springtails (*Collembola*) *Folsomia candida*,
- plants: plant growth using different species. e.g. monocotyledonous oat (other crops) and dicotyledonous turnip and cress.

## 2. Instruction for the class

### IMPORTANT:

Make notes of your activity and measurements immediately. Label all used glassware (beakers, crystallizers) with a code name of sample etc., using a permanent marker. In case of high temperature treatment (550°C), use pencil.

### BASIC SOIL PROPERTIES

#### Moisture content

Weigh a labelled glass crystallizer, with an accuracy of 0.001 g ( $m_0$  [g]). Put about 10–15 g of soil into this crystallizer, and weigh it again ( $m_1$  [g]).

Place it in a dryer (105°C)

After drying overnight, the crystallizer will be placed in a desiccator. Weigh it again ( $m_2$  [g]).

$$\text{moisture, \%} = \frac{(m_1 - m_2)}{(m_1 - m_0)} \times 100\%$$

## Organic matter (loss on ignition)

1. Weigh a labelled crucible (use pencil), with an accuracy of 0.001 g ( $m_c$  [g]).
2. Put about 10 g of previously dried soil to this crucible, and weigh it again ( $m_s$  [g]).
3. Place it in an oven (550°C).
4. After combustion, the crucible will be placed in a desiccator to cool down. Weigh it again once cooled ( $m_f$  [g]).

$$\text{organic matter, \%} = \frac{(m_s - m_f)}{(m_s - m_c)} \times 100\%$$

## pH of soil

1. Measure 5 ml of soil into two labelled bottles.
2. Add 25 ml of demineralized water to the first bottle, and 25 ml of 0.01 M KCl to the second. Close the bottles.
3. Place the bottles in a shaker and shake them for 1 h.
4. Measure pH using a pH meter in both bottles. Electrode should be immersed, wait until the readout stabilizes.



## Soil texture (type)

1. Weigh 800 ml labelled glass beaker ( $m_b$ ) and a labelled crystallizer ( $m_z$ ).
2. Weigh 15 g of soil in a labelled bottle, with an accuracy of 0.01 g.
3. Add 45 ml of 3% solution of sodium hexametaphosphate (HMP) (which acts as agent dispersing soil aggregates). Close the bottle.
4. Place it in a shaker, shake for 1 h.
5. After shaking, filter the bottle content through 0.063 mm sieve, collecting the filtrate in the beaker.
6. Rinse the residue with several portions of demineralized water, collecting the filtrate in the beaker. The final volume of the filtrate in the beaker should be 600–800 ml.
7. Leave the sieve to dry. After the sand is dried, carefully transfer it in the weighted crystallizer. Place the crystallize in a dryer (105°C).
8. Stir the beaker content using glass rod. Leave it for at least 1.5 h.
9. Carefully decant the liquid, leaving the sediment in the beaker.
10. Place beaker in a dryer (105°C). Next day, after cooling, weigh the beaker ( $m_n$ ) and the crystallizer ( $m_k$ )

$$\text{sand, \%} = \frac{(m_k - m_z)}{15} \times 100\%$$

$$\text{silt, \%} = \frac{(m_n - m_b)}{15} \times 100\%$$

$$\text{clay \%} = 100\% - \text{sand, \%} - \text{silt, \%}$$

11. Basing on percentages of sand, silt and clay content, determine soil type using USDA classification graph (triangle).

NOTE: this procedure is a shortened version of method described by Kettler et al., 2001; (shaking time reduced from 2 h to 1 h, due to time constraints).

## TEST FOR ROOT GROWTH INHIBITION

1. Place 90 ml of clean soil in a small plastic beaker.
2. Pour 50 ml of water in the soil, using a measuring cylinder; mix it well using a spatula, until soil is completely wet.
3. Wait a while for particles to settle, and then carefully decant water remaining above soil back in the cylinder. Take care not to carry over soil particles. Repeat it a few times, until almost all free water is drained.
4. Record the volume of water in the cylinder. The difference to the 50 ml is the water holding capacity (WHC) of 90 ml of soil.
5. Place 90 ml of clean soil into a bottom compartment of 3 plastic test plates.
6. Slowly wet each portion of soil with the WHC volume of water, determined previously, using a plastic pipette (a few drops at a time).
7. Mix and level the soil flat, using a spatula.
8. Cover it with black paper filter and wait until filter is wet.
9. About 1 cm from the top of filter, in one line at equal distances, place 10 seeds of: first plate – cress, second – mustard, third – sorghum. First and second are dicotyledonous plants, third – monocotyledon.
10. Cover the plate with a lid and click it around. Label appropriately (soil type – plant).
11. Repeat points 5–10 with two contaminated soils.

12. Place the tests plates vertically in a box, and put it in an incubator (25°C in darkness).
13. On the 3<sup>rd</sup> day, measure roots length in mm.
14. Calculate mean root length for each plant and each soil

$$\text{root growth inhibition, \%} = \frac{(l_c - l_t)}{l_c} \times 100\%$$

where:  $l_c$  – mean root length in control (clean soil),  $l_t$  – mean root length in test sample (contaminated).

15. Weigh 50 g of contaminated soil in a beaker.
16. Pour 50 ml of demineralized water, mix it well.
17. Decant remaining water in conical flask.
18. Repeat rinsing (p. 16–17) 2 more times.
19. If water is very turbid, centrifuge it.

20. Measure copper content titrimetrically: add 20 ml of potassium hydrogen phthalate solution and mix the content. Then add 5g of potassium iodide (KI) and 10 ml of potassium thiocyanate (KSCN) solution. Place in dark place for 5 min. After this, add a few ml of starch solution and titrate with 0.025 n solution of sodium thiosulphate ( $\text{Na}_2\text{S}_2\text{O}_3$ ) until black colour completely disappears. Note: 1 ml of thiosulphate solution corresponds 1.589 mg of  $\text{Cu}^{2+}$ . Calculate copper concentration per kg of each soil, multiplying the result by 20.
21. Repeat for other used soils samples: clean soil and the other contaminated soil (3 determinations in total).

### 3. Preparation of report

Label the report with names of students and topic of the laboratory class. Prepare it on stapled sheets of paper, printed on both sides.

In the report, give all the measurements (weights, etc.) and calculations. Important points:

- explain the difference in pH measurements done in clean water and potassium (calcium) chloride solution;
- determine the soil type using USDA triangle (picture to be included in the report);
- for root growth inhibition, prepare graphs relating inhibition effect (%) to copper concentration in soil (one for each plant).

Laboratory class 2

**Mobility of heavy metals  
and their remediation**



# 1. Introduction

Heavy metals, such as lead, cadmium, mercury, chromium, copper, zinc, nickel, arsenium etc., are some of the most common soil pollutants. Sources of heavy metals are: mining activity, industrial waste and wastewater, flooding, atmospheric deposition etc.; they can build-up in soils as a result of the use of contaminated fertilizers, including “natural” ones – such as wastewater sludge.

Heavy metals can be present in soil and groundwater environment as ions at different oxidation states (valency, e.g.  $\text{Cu}^+$ ,  $\text{Cu}^{2+}$ ,  $\text{Cr}^{3+}$ ,  $\text{Cr}^{6+}$ ). They can interact with soil components by way of several mechanisms – such as: complexation (organic and inorganic complexes), precipitation/dissolution, ion exchange, sorption/desorption by minerals and organic sorptive complex. These reactions are governed by pH, redox condition, presence of specific minerals (e.g. carbonates; iron, manganese oxides) and soil compounds (e.g. clays, humus), resulting in different metal mobility, bioavailability and toxicity.



As being elements, heavy metals cannot be degraded. Therefore, remediation of heavy metals-contaminated soils can be performed in two ways: by removing them from soil (extraction, leaching) or by making them non-mobile and/or non-available. The latter could be done either by solidification/binding or by stabilization/immobilization of the contamination.

Extraction of heavy metals could be accomplished by using chemicals (rinsing of soil), such as:

- synthetic aminopolycarboxylic acids, e.g. EDTA
- natural biodegradable acids
- low-molecular organic acids, e.g. citric, oxalic
- humic substances, e.g. humic and fulvic acids,

which remove heavy metals as chelates (complexes) or in adsorbed forms.

Another method of extracting heavy metals from soil is the use of selected plants (phytoremediation) that are capable of uptake and accumulation of these pollutants. Especially valuable are hyperaccumulating species, able to concentrate heavy metals at a concentration tens or hundreds times higher than that occurring in the soil. Examples of used plants are: sunflower, sorghum, hemp, maize, elephant grass, and many others. Phytoremediation can be applied with a combination of the above-mentioned chemical means, which enhance metals desorption and uptake by plant roots.

The terms solidification/stabilization are often used inseparably, as they are akin, referring to different aspects of similar treatment.

Solidification means binding contaminants with an added binder, forming a solid block out of soil, thus trapping contaminants in place. Binders can be inorganic, such as cement, lime, fly ash, clay, diatomaceous earth, etc.; organic: asphalt/bitumes, polymers, polystyrene, polyurethane etc.; or mixed. Vitrification can be regarded as a special case of solidification; this is melting soil at a very high temperature in a glass-like substance.

Stabilization is applied to soluble contaminants and it involves reduction of their water solubility, and thus mobility in soil/groundwater environment. It makes use of mechanisms such as (ad)sorption of contaminants, ion-exchange, precipitation etc. Several reagents can be used, e.g. it is possible to increase sorption capacity of soil using organic additives (humus, organic wastes, compost, lignite and so on). Zeolites or fly ash can be used as inorganic sorbents. Heavy metals can be precipitated as low-soluble carbonate, phosphate, hydroxide or sulphide. This involves the addition of reagents e.g. lime ( $\text{Ca}(\text{OH})_2$ ) or potash ( $\text{KOH}$ ) for precipitating metal hydroxide; sulphide (like sodium sulphide  $\text{Na}_2\text{S}$ ), polysulfide, metabisulphite. Precipitation of sulphide can be also be done biologically (bioprecipitation), by stimulating indigenous sulphate reducing bacteria transforming sulphates present in groundwater to hydrogen sulphide ( $\text{H}_2\text{S}$ ), which in turn reacts with metals forming insoluble sulphide. This stimulation is done by the addition of an easily degradable substrate (e.g. molasses, lactate or lactate polymers). Solubility of metal salts depends on pH of environment so this factor has to be included when considering remediation options, e.g. in the case of hydroxide precipitation buffering capacity of groundwater can result in pH drop and re-dissolving of metals.

## Solubility of hydroxides and sulphides of different metals in relation to pH

316

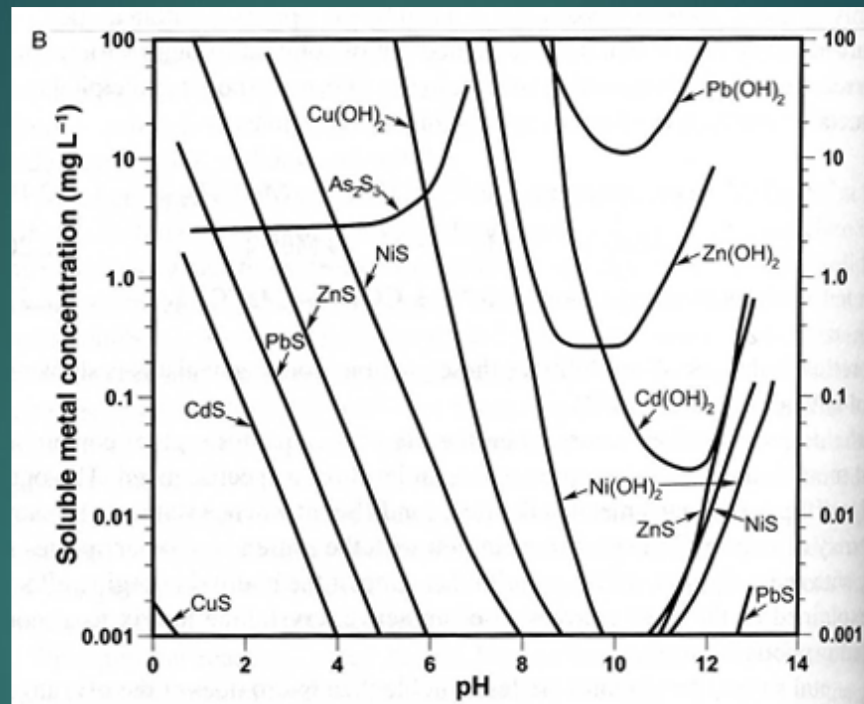

Source: Suthersan, Payne. In situ remediation engineering. CRC Press 2005

A special method of treatment is the use of permeable reactive barriers, i.e. deep trenches filled with special material that purify the groundwater flowing through. In case of heavy metal pollution, this filling material includes ion-exchange resins, fly ash, zeolites or activated carbon. For chromium, metallic iron is used as this reduces Cr<sup>+6</sup> into less soluble and less toxic Cr<sup>+3</sup>.

## 2. Instruction for the class

317

### IMPORTANT:

1. Make notes of your activity and measurements immediately. Label all used glassware with a code name of sample etc., using a permanent marker.
2. Prepare 5 beakers and number them from 1 to 5.
3. Add 8 ml of copper sulphate solution to each beaker.
4. Fill up each beaker to 100 ml using demineralized water and mix it well. For beaker 4, use alkalized water.
5. Add 2 ml of  $\text{Na}_2\text{S}$  solution to beaker 5, mix it and leave all beakers for at least 0.5 h.
6. Prepare 5 glass columns and number them.
7. Weigh 5 portions of 100 g of soil.
8. Fill the columns 1, 4 and 5 with measured amount of soil.
9. Add a half of portion of soil to column 2, then add about 1–2 cm layer of ash, and finally the rest of the soil.
10. Prepare column 3 similarly as in p. 8, using organic soil instead of ash.

11. After at least 0.5 h (see p. 4), slowly pour the content of the beaker through the respective columns, collecting the effluent.
12. Slowly pour 100 ml of acidified water through columns 4 and 5; collect the effluents. Measure the pH of the acidified water.
13. Measure copper content titrimetrically in each effluent: add 20 ml of potassium hydrogen phthalate solution and mix the content. Then add 5g of potassium iodide (KI) and 10 ml of potassium thiocyanate (KSCN) solution. Put in a dark place for 5 min. Then add a few ml of starch solution and titrate with 0.025 n solution of sodium thiosulfate ( $\text{Na}_2\text{S}_2\text{O}_3$ ) until black colour completely disappears. Herein, 1 ml of thiosulfate solution corresponds 1.589 mg of  $\text{Cu}^{2+}$ . Calculate copper content in each eluent.

## Preparation of report

Label the report with names of students and topic of the laboratory class. Prepare it on stapled sheets of paper, printed on both sides.

In the report, give all the measurements (volumes of titrant, etc.) and calculations.

Explain the differences of copper content in the effluents from the different columns. What were the mechanisms of copper binding/immobilization in each treatment?

Laboratory class 3

**Remediation by chemical  
oxidation: Fenton's reagent**



## 1. Introduction

Chemical oxidation is a widely applied in-situ soil and groundwater remediation method. It involves application (e.g. by injection or sparging through set of wells, mixing with soil at a site) of a strong oxidant that transforms (oxidizes) pollutants (in the best case) into simple inorganic products like carbon dioxide, water, chloride etc. More often the results are several intermediate products that should preferably be of lower toxicity and better degradability than the parent compounds. However, sometimes some intermediate metabolites could be even more harmful, so oxidation should be performed in a manner avoiding their formation or causing their further degradation.

Oxidation is applied for soils contaminated with organic pollutants, such as petroleum products, aromatics, chlorinated alkenes and alkanes, PAHs, PCBs, dioxins, pesticides, explosives and so on. Reagents used as oxidants are:

- hydrogen peroxide, alone or with activators like Fe(III) or Fe(II) (Fenton reagent)
- sodium or potassium permanganate
- ozone
- sodium persulphate, alone or with activators
- peroxone (mixture of hydrogen peroxide and ozone)
- etc.

These reagents differ in their properties, reaction rates and effectiveness towards different pollutants, methods of delivery etc.

One of the most commonly used methods is oxidation using Fenton's reagent (catalyzed hydrogen peroxide – CHP). Oxidation with hydrogen peroxide alone is quite slow, and its reactivity towards organic compounds is rather weak. In 1894, J.H. Fenton found that  $\text{Fe}^{2+}$  ions are strong catalyst of oxidation reactions with hydrogen peroxide. This reaction produces hydroxyl radicals  $\text{HO}\cdot$  of very strong oxidizing properties (2.80 V oxidation potential, one of the highest):



In this reaction, other types of radicals are also formed. These include superperoxide anion  $\text{O}_2\cdot^-$ , perhydroxyl radical  $\text{HO}_2\cdot$ , etc. The next stages are the regeneration of  $\text{Fe}^{2+}$  ions, and a cascade of other reactions:

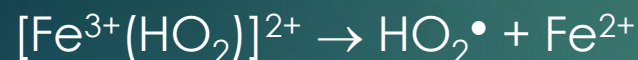

The whole course of the reactions is very complicated, only selected ones are shown above.

The hydroxyl radicals react with organic compounds to form alkyl, alkylperoxy radicals that are subsequently degraded to form simpler organic compounds (e.g. carboxylic acids), or undergo polymerization. Subsequent oxidation of intermediates leads to mineralization, i.e. formation of carbon dioxide, water, chlorides, ammonia, etc. In the example of phenol (see figure), in the first stage of reaction with the Fenton reagent, it is oxidized to dihydroxybenzenes and benzenoquinones, which are then oxidized to ever simpler organic acids. The essential notion is that the original reaction products – hydroquinone and benzoquinone – are far more toxic than phenol itself, hence the need to conduct an advanced and prolonged oxidation.

## Proposed route for oxidation of phenol by Fenton reagent

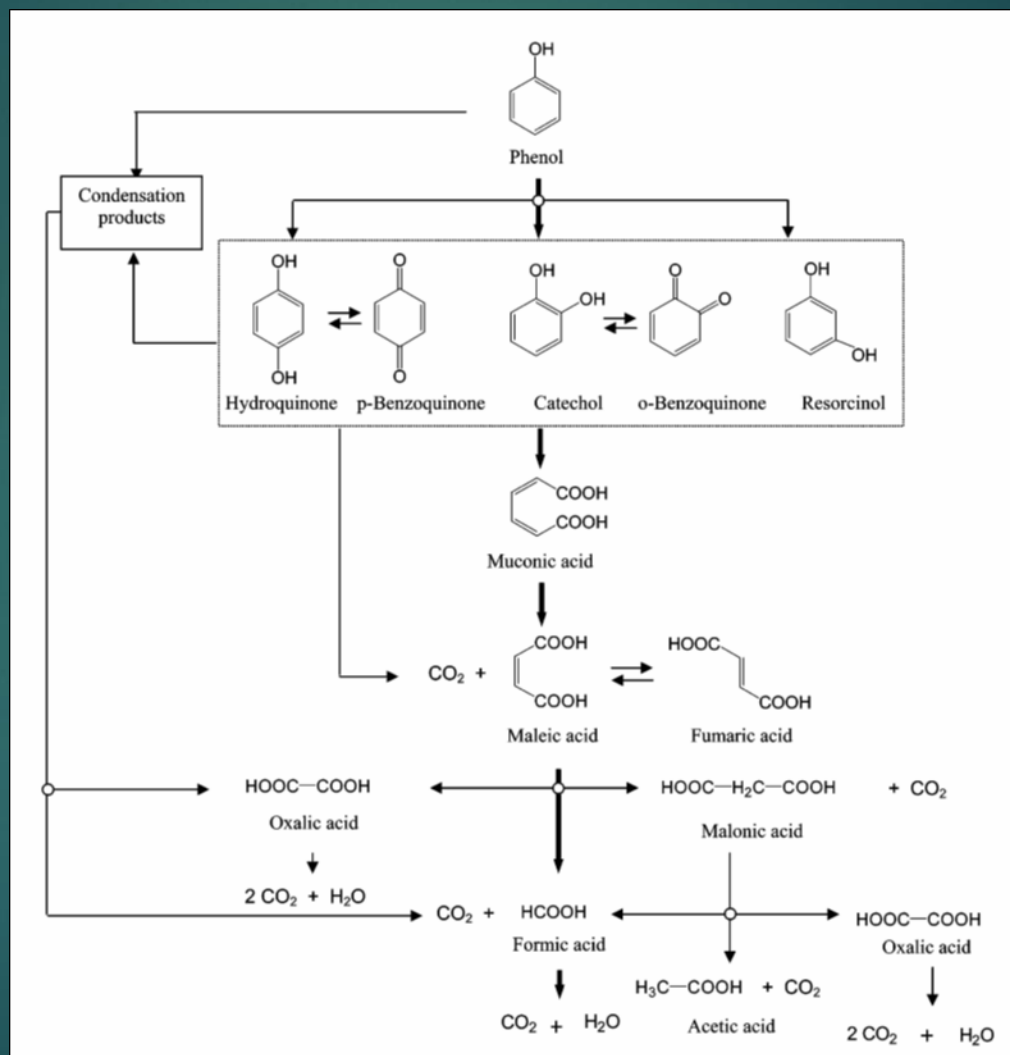

In practice, formed radicals react not only with target chemicals, but also with the carbonates and bicarbonates present in groundwater (so called “oxidant scavengers”), soil organic matter, chloride, sulphate, etc. There are also unproductive reactions between the radicals themselves. As a result, only a small fraction of applied peroxide is used in desired reactions with pollutants. Thus, during remediation it has to be applied in huge excess, depending on local conditions.

The effectiveness of Fenton's reaction depends on:

- pH
- concentration of  $\text{Fe}^{2+}$  catalyst
- temperature
- amount of peroxide in relation to the amount of impurities (consumption by unproductive reactions)

The optimal pH range for Fenton reaction is 3–4. At higher values (>5),  $\text{Fe}^{3+}$  may precipitate, e.g. in the colloidal form, causing decomposition of hydrogen peroxide into water and oxygen without formation of hydroxyl radicals. Moreover, pH also affects the formation of radicals, their reactivity, etc.

Increasing the concentration of iron ions (until a certain threshold) also has input into the reaction rate. Finally, the Fe to substrate ratio may influence the types of reaction products formed.

During soil and groundwater remediation, a problem that arises is maintaining appropriate pH level due to the buffering capacity of groundwater (because of the presence of dissolved carbonate species). Therefore, different application strategies are used. Among these are:

- groundwater acidification to pH 3–5, then short peroxide injections. After the "rebound" of pH, the acidification-oxidation cycle is repeated until the goal is achieved. Another possibility is compensation of  $\text{Fe}^{2+}$  losses (resulting from  $\text{Fe}^{2+}$  precipitation)
- use of chelating agents to keep the iron in dissolved form
- use of ferruginous minerals as catalyst: based on the initiation of the formation of radicals by iron-containing minerals, e.g. goetite  $\alpha\text{-FeOOH}$ . (depends on local conditions).

## 2. Instruction for the class

As performing Fenton oxidation in the soil environment would be too complicated and time consuming, the exercise will be simplified. Reaction is to be carried out in the water phase, using the example of phenol as a model pollutant. Effectiveness will be assessed on the base of parent product (phenol) concentration and COD (chemical oxygen demand) determination, which is an indirect way of measuring organic compounds total content (in this case, not only phenol, but also its oxidation products).

**IMPORTANT: Hydrogen peroxide and sulphuric acid are very corrosive! Handle them with care – wear gloves, button your apron, use eye protection and work under supervision. During operations for COD measurement (cooling etc.), keep the flask opening directed away from you and not towards other people. Transfer the contents of the flask with care.**

Make notes of your activity and measurements immediately. Label all used glassware with the code name of the sample etc., using a permanent marker.



1. Measure 0.5 dm<sup>3</sup> of the 100 mg/dm<sup>3</sup> phenol solution into the beaker. Put in a mixing rod and place the beaker on a magnetic stirrer and start mixing (settings between “50” and “500”).
2. Adjust the pH to between 3–4 using 1 M sulphuric acid (a couple of drops is usually enough).
3. Add a 0.25 or 0.5 ml volume of 1% ferrous sulphate solution (FeSO<sub>4</sub> × 7H<sub>2</sub>O).
4. Then add 0.75 ml of 30% hydrogen peroxide solution and start the time measurement. Pay attention to colour changes of the liquid – take notes or photo every 5 minutes.
5. Using the remaining phenol solution, determine the initial phenol concentration by spectrophotometric method (a) and assess the initial COD (b):
  - a. spectrophotometric determination of phenol: measure 10 ml of the sample into a 100 ml volumetric flask and fill it up to the mark with deionized water. Add 1 ml of ammonium buffer, then 2 ml of the aminoantipyrine solution and 2 ml of potassium ferricyanide solution.

Wait 15 min (but not more than 25 min) and determine adsorbance at 510 nm in 1 cm cuvettes, using a spectrophotometer (ask the teacher for instruction). Simultaneously, in the same way, prepare a blank sample using 10 ml of deionized water (due to the instability of the colour, prepare the blank each time when measuring phenol – one blank can serve for all groups). The concentration of phenol should be determined from the formula:

$$C = 0.728 \times \text{Abs} \times 1000/V$$

where “Abs” is the measured absorbance and V is the volume of sample in ml (here 10 ml).

- b. COD determination: measure 20 ml of sample to a round flask, then add 10 ml of 0.25 n potassium dichromate solution and a boiling chip or glass ball. Then carefully add 40 ml of concentrated sulphuric acid (under a ventilation hood), mix and place the flask in the heating mantle, attaching a reflux condenser. Start heating and continue it for 10 min after the liquid starts boiling. Turn off heating and lift the flask with condenser still attached, placing in on a mat to cool down.

After 10 min, slowly pour 50 ml of deionized water through the top of condenser. Disassemble the set and start cooling the flask under the stream of cold tap water, to the ambient temperature. Add 3–4 drops of ferroin and start titration using 0.125 n Mohr's salt solution, until a colour change. Simultaneously, prepare a blank sample using a 20 ml of deionized water, and handle it in the same way as above (one blank is enough for all groups and the whole exercise). Calculate the result using the formula:

$$X = (a - b) \times 0.125 \times 8 \times 1000/20 = (a - b) \times 50$$

where "a" is the volume of Mohr's salt used for titration of blank and "b" is the volume of Mohr's salt used for titration of sample.

6. After 15 minutes of mixing, take 100 ml of liquid from the beaker and add a drop of NaOH solution to stop the reaction. Use this sample for the following determinations (it is necessary to perform p. 6b before p. 6c):
  - a. phenol concentration (as in p. 5a). Remember about preparation of a fresh blank

- b. remaining hydrogen peroxide: take 10 ml from the sample and add 10 ml of 1 M sulphuric acid ( $\text{H}_2\text{SO}_4$ ), 10 ml of 2% potassium iodide (KI) solution and a few ammonium molybdate crystals (tip of a spoon). Set aside for 5 minutes in the dark (e.g. in a cupboard). Add starch and titrate with 0.025 N sodium thiosulphate until dark colour disappears completely. Record the volume of thiosulphate as "X"
- c. COD: Measure out 50 ml from the sample, acidify it with 5 ml of 1 M sulphuric acid and **add 2.5 ml of 0.025 M sodium sulphite solution for each 1 ml of the thiosulphate solution consumed during the titration in p. 6b ( $2.5 \times X$ )**. Then carry out the COD determination as in p. 5b, taking 20 ml of such prepared liquid (no need for another blank). Result of COD measurement should take dilution of the sample into consideration: after calculating the result using the formula given in p. 5b, multiply it by  $[(50+5+\text{volume of added thiosulphate})/50]$ .
7. After 30 minutes of mixing (45 minutes from start), take a 100 ml sample from the beaker and add a drop of NaOH solution to it to stop the reaction. Using the collected liquid, make measurements as in p. 6a–c. It might be useful to take a larger volume of a sample (more than 10 ml) for phenol determination due to its low concentration.

### 3. Preparation of report

Label the report with names of students and topic of the laboratory class. Prepare it on stapled sheets of paper, printed on both sides.

In the report, give all the measurements (volumes of titrant, etc.) and calculations for every measurement. Calculate effectiveness of phenol and COD removal (% decrease in relation to initial value).

Using the determined phenol concentrations, calculate theoretical COD by using a factor of 2.38 mg COD/mg of phenol.

Present all the results (phenol, COD, COD theoretical, effectiveness of phenol and COD removal) in relation to reaction time in a table or graph.

What is the reason for the discrepancies in removal of phenol and COD, and between theoretical and measured COD? Explain the colour changes of the sample during reaction – what compounds are likely to be responsible for these changes? By consulting the results of the other groups, discuss the influence of time and iron (II) dose on the effectiveness of Fenton oxidation.

# Course programme

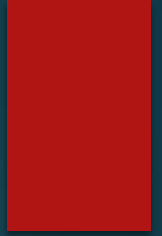

## Lectures

1. Characterisation of soil and groundwater environment; common inorganic and organic pollutants and their fate in soil and groundwater; their mobility and sequestration
2. Standards of soil and groundwater quality: presentation of current Polish and other national standards
3. Risk assessment methods for soil and groundwater contamination: methods of HRA, ERA, agricultural productivity; TRIAD, RBCA
4. Immobilization and barrier methods: physical barriers, hydraulic barriers, physical-hydraulic barriers; permeable barriers; immobilisation of metals
5. Physical methods of remediation: LNAPL skimming, vapour extraction, multiphase extraction, pump-and-treat, thermal desorption, soil washing and flushing, soil venting, air sparging
6. Chemical methods of remediation: in-situ oxidation and reduction
7. Bioremediation of soil and groundwater: natural attenuation and intensive biotreatment; different in- and ex-situ methods, bioremediation in different conditions and its requirements

## Laboratory classes

1. General characterization of soil sample; removal of petroleum hydrocarbons by soil rinsing
2. Immobilization of heavy metals in soil, different techniques
3. Oxidation of contaminant by Fenton reagent (by the example of phenol)



# Literature



1. Alvarez P.J., Illman W.A. (2005). *Bioremediation and natural attenuation. Bioremediation and Natural Attenuation: Process Fundamentals and Mathematical Models*. Hoboken: John Wiley & Sons.
2. Baczyński T., Małachowska-Jutcz A., Szalińska E. (2018). *Toxicological assessment of pesticide contaminated soils with use of biotests*. *Geology, Geophysics and Environment* 44(2). Available at: <https://journals.agh.edu.pl/geol/article/view/2815>
3. Brown R., Wilson J., Ferrey M. (2007). *Monitored Natural Attenuation Forum: The Case for Abiotic MNA*. *Remediation Journal* 17(2), pp. 127–137.
4. Declercq I., Cappuyns V., Duclos, Y. (2012). *Monitored natural attenuation (MNA) of contaminated soils: state of the art in Europe – a critical evaluation*. *Science of the Total Environment* 1(426), pp. 393–405.
5. Domenico P.A., Schwartz F.W. (1998). *Physical and Chemical Hydrogeology*. New York: John Wiley & Sons.
6. Frey S. (2007). *Soil microbiology, Ecology and Biochemistry*, Elsevier.
7. Foght, J. (2008). *Anaerobic biodegradation of aromatic hydrocarbons: pathways and prospects*. *Journal of molecular microbiology and biotechnology* 15(2–3), pp. 93–120.
8. Haggerty R., Schroth M.H, Istok J.D. (1998). *Simplified Method of “Push-Pull” Test Data Analysis for Determining In Situ Reaction Rate Coefficients*. *Ground Water* 36(2), pp. 314–324.
9. Häggblom M.M., Bossert I.D. (2003). *Dehalogenation*. Berlin: Springer.

10. Harbaugh, A.W. (2005). *MODFLOW-2005, The U.S. Geological Survey Modular Ground-Water Model – the Ground-Water Flow Process*. Available at: <https://pubs.usgs.gov/tm/2005/tm6A16/>
11. Harmsen J. (2007). *Measuring Bioavailability: From a Scientific Approach to Standard Methods*. *Journal of Environmental Quality* 36(5), pp. 1420–1428.
12. Hasegawa H., Mofizur Rahman I., Azizur Rahman M., Eds. (2016). *Environmental remediation technologies for metal-contaminated soils*. Berlin: Springer.
13. Holliger Ch., Regeard Ch., Diekert G. (2004). *Dehalogenation*. Boston: Springer.
14. Honders T. (2009). *New Risk-Based Soil Quality Standards in the Netherlands*. Lyon: WASCON.
15. <https://www.mos.gov.pl/kalendarz/szczegoly/news/wyjasnienie-1/>
16. Huling S.G., Pivetz B.E. (2006). *In-Situ Chemical Oxidation*. Engineering Issue of EPA. United States Environmental Protection Agency.
17. Ibrahim A. (2008). *Mirsal, Soil Pollution: Origin, Monitoring & Remediation*. Berlin: Springer.
18. Jensen J., Mesman M. (2006). *Ecological Risk Assessment of Contaminated Land: Decision support for site specific investigations*. Utrecht: RIVM.
19. JRC scientific and technical report (2007). Derivation methods of soil screening values in Europe.
20. JRC technical reports (2018). Status of local soil contamination in Europe.
21. Kettler T., et al. (2001). *Simplified method for soil particle-size determination to accompany soil-quality analyses*. *Soil Sci Soc Am J* 65, pp. 849–852.

22. Klimkowicz-Pawlas A., Maliszewska-Kordybach B. & Smreczak B. (2013). *Metody oceny ryzyka ekologicznego terenów narażonych na oddziaływanie zanieczyszczeń organicznych*. *Studia i Raporty IUNG-PIG* 35(9), pp. 155–179.
23. Langenhoff A.A.M., Staps J.J.M., Pijls C.G.J.M., Alpehnaar A. (2002). *Intrinsic and Stimulated In Situ Biodegradation of Hexachlorocyclohexane (HCH)*. *Water, Air & Soil Pollution: Focus* 2(3), pp. 171–181.
24. Lettinga G., Hulshoff-Pol L.W., Zeeman G. (1999). *Lecture notes: Biological wastewater treatment; part I anaerobic wastewater*. Wageningen: Wageningen University.
25. Margesin R., Schinner F. (2005). *Manual for Soil Analysis – Monitoring and Assessing Soil Bioremediation*. Berlin–Heidelberg: Springer Verlag.
26. Malina G. (2007). *Likwidacja zagrożenia środowiska gruntowo-wodnego na terenach zanieczyszczonych*. Monografia 132. Częstochowa: Wydawnictwo Politechniki Częstochowskiej.
27. Maliszewska-Kordybach B., Smreczak B., Klimowicz-Pawlas A. (2014). *Evaluation of the Status of Contamination of Arable Soils in Poland with DDT and HCH Residues; National and Regional Scales*. *Polish Journal of Environmental Studies* 23(1), pp. 139–148.
28. Marchiori A., Li Y., Evans J.C. (2009). *Design and Evaluation of IoT-Enabled Instrumentation for a Soil-Bentonite Slurry Trench Cutoff Wall*. *Infrastructures* 4(1), 5.

29. National Research Council (2003). *Bioavailability of Contaminants in Soils and Sediments: Processes, Tools, and Applications*. Washington, DC: The National Academies Press. <https://doi.org/10.17226/10523>
30. Nowak K., Kwapisz J. (2017). *Ocena zanieczyszczenia powierzchni ziemi*. Warszawa: Departament Gospodarki Odpadami. Available at: <https://sdr.gdos.gov.pl/Documents/PZ/Spotkanie%2015.02.2017/Prezentacja%2015.02.2017.pdf>
31. O'Carroll D., et al. (2013). *Nanoscale zero valent iron and bimetallic particles for contaminated site remediation*. *Advances in Water Resources* 51, pp. 104–122.
32. O'Donnell S.A., Rumer R.R., Mitchell J.K., Eds. (1995). *Assessment of Barrier Containment Technologies: A Comprehensive Treatment for Environmental Remediation Applications*. Sponsored by U.S. DOE, U.S. EPA, and Dupont Company. NTIS: PB96-180583.
33. Parsons (2004). *Principles and Practices of Enhanced Anaerobic Bioremediation of Chlorinated Solvents*. Available at: [https://frtr.gov/costper-formance/pdf/remediation/principles\\_and\\_practices\\_bioremediation.pdf](https://frtr.gov/costper-formance/pdf/remediation/principles_and_practices_bioremediation.pdf)
34. Reid B.J., Jones K.C., Semple K.T. (2000). *Bioavailability of persistent organic pollutants in soils and sediments – a perspective on mechanisms, consequences and assessment*. *Environmental Pollution* 108(1), pp. 103–112.
35. Rozporządzenie Ministra Środowiska z dnia 21 grudnia 2015 r. w sprawie kryteriów i sposobu oceny stanu jednolitych części wód podziemnych, Dz.U. 2016 poz. 85.

36. Rozporządzenie Ministra Środowiska z dnia 1 września 2016 r. w sprawie sposobu prowadzenia oceny zanieczyszczenia powierzchni ziemi, Dz.U. 2016 poz. 1395.
37. Rozporządzenie Ministra Zdrowia z dnia 7 grudnia 2017 r. w sprawie jakości wody przeznaczonej do spożycia przez ludzi, Dz.U. 2017 poz. 229.
38. Sayles G.D., You G., Wang M., Kupferle M.J. (1997). *DDT, DDD, and DDE dechlorination by zero-valent iron*. *Environmental Science & Technology* 26; 31(12), pp. 3448–3454.
39. Semple K.T., Morris A.W.J., Paton G.I. (2003). *Bioavailability of hydrophobic organic contaminants in soils: fundamental concepts and techniques for analysis*. *Eur. J. Soil. Sci.*, 54, pp. 809–818.
40. Sherameti I, Varma A., Eds. (2015). *Heavy metal contamination in soils*. Berlin: Springer.
41. Siegrist R.L., Crimi M., Simpkin T.J. (2011). *In situ chemical oxidation for groundwater remediation*. Berlin: Springer.
42. Singh A., Ward O.P. (2004). *Applied Bioremediation and Phytoremediation*. Berlin: Springer.
43. Smreczak B., Klimkowicz-Pawlas A., Maliszewska-Kordybach B. (2013). *Biodostępność trwałych zanieczyszczeń organicznych (TZO) w glebach na przykładzie wielopierścieniowych węglowodorów aromatycznych (WWA)*. [In:] *Zagrożenia dla prawidłowego funkcjonowania gleb użytkowanych rolniczo – wybrane zagadnienia*. Puławy: IUNG-PIB, 35(9), pp. 137–154.

44. Steliga T. (2009). *Bioremediacja odpadów wiertniczych zanieczyszczonych substancjami ropopochodnymi ze starych dołów urobkowych*. Kraków: INiG.
45. Stroo H.F., Ward C.H. (2010). *In Situ Remediation of Chlorinated Solvent Plumes*. Berlin: Springer.
46. Stroud J.L., Paton G.I., Semple K.T. (2007). *Microbe–aliphatic hydrocarbon interactions in soil; implications for biodegradation and bioremediation*. *J. Appl. Microbiol*, 102, pp. 1239–1253.
47. Suthersan S.S. (1997). *Remediation Engineering*. CRC Press.
48. Suthersan S.S., Payne F.C. (2004). *In situ remediation engineering*. CRC Press.
49. Wciśło E. (2009). *Ocena ryzyka zdrowotnego w procesie remediacji terenów zdegradowanych chemicznie – procedury i znaczenie*. Białystok: Wydawnictwo Ekonomia i Środowisko.
50. Wiedemeier T.H., Wilson J.T., Kampbell D.H. (1996). *Natural attenuation of chlorinated aliphatic hydrocarbons at Plattsborough Air Force Base, New York*. Symposium on Natural Attenuation of Chlorinated Organics in Groundwater. Dallas, September 11–13. EPA/540/R-96/509, pp. 74–82.
51. Wilson J.T., et al. (2010). *Abiotic and Biotic Transformation of TCE under Sulfate Reducing Conditions: the Role of Spatial Heterogeneity*. Seventh International Conference: Remediation of Chlorinated and Recalcitrant Compounds, May 24–27, Monterey, California.

52. Zazo J.A., et al. (2005). Chemical pathway and kinetics of phenol oxidation by Fenton's reagent. *Env Sci Technol* 39, pp. 9295–9302.
53. Zhang W. (2003). Nanoscale iron particles for environmental remediation: an overview. *Journal of nanoparticle Research*, 5.3–4, pp. 323–332.





**Cracow University  
of Technology**

eISBN 978-83-66531-59-8